

DreamCast

design and production

Match Lit Firepit with Standing Pilot 60k - 250k BTU with Safety Shut-off Installation & Operation Manual

Certified to
ANSI STD Z21.97 - 2017
CSA STD 2.41 - 2017



OUTDOOR DECORATIVE
GAS APPLIANCES
CERTIFIED FOR USA & CANADA



We recommend that our fire pits
be installed and serviced by
professionals that are certified in the
U.S. by NFI
(National Fireplace Institute)

WARNING: If the information in this manual is not followed exactly, a fire or explosion may result causing property damage, personal injury, or loss of life.

⚠ DANGER
FIRE OR EXPLOSION HAZARD

If you smell gas:

- Shut off gas to the appliance.
- Extinguish any open flame.
- If odor continues, leave the area immediately.
- After leaving the area, call your gas supplier or fire department.

Failure to follow these instructions could result in fire or explosion, which could cause property damage, personal injury, or death.

⚠ WARNING: For Outdoor Use Only.

Installation and service must be performed by a qualified installer, service agency, or the gas supplier.

INSTALLER: Leave this manual with the appliance.
CONSUMER: Retain this manual for future reference.

| | |
|---|---|
|  DANGER | CARBON MONOXIDE HAZARD |
| | <p>This appliance can produce carbon monoxide which has no odor.</p> <p>Using it in an enclosed space can kill you.</p> <p>Never use this appliance in an enclosed space such as a camper, tent, car or home.</p> |

⚠ WARNING

Improper installation, adjustment, alteration, service or maintenance can cause injury or property damage. Read the installation, operating and maintenance instructions thoroughly before installing or servicing equipment.

⚠ WARNING

Do not store or use other flammable vapors and liquids in the vicinity of this or any other appliance. An LP-cylinder not connected for use shall not be stored in the vicinity of this or any other appliance.

The installer is responsible for using the correct fuel line sizing and/or regulation to provide gas within the specified minimum and maximum gas inlet pressures of the fire feature.

General Information

This Owner's Guide and Instruction Manual contains critical information for the safe installation and operation of your DreamCast fire feature. *You must read this manual in its entirety prior to installation and/or operation.*

Failure to follow these instructions may result in property damage, personal injury, or death.

IMPORTANT: This appliance should be inspected before use and at least once annually by a qualified service person. More frequent cleaning may be required as necessary. It is imperative that the control compartment, burners and circulating air passageways of the appliance be kept clean. If it is evident that the burner is damaged it must be replaced prior to the appliance resuming operation. Contact DreamCast for a replacement.

DANGER: Carbon monoxide poisoning can lead to death!

CARBON MONOXIDE POISONING:

Early signs of carbon monoxide poisoning resemble the flu, with symptoms including headache, dizziness, or nausea. If you experience these signs, the Fire Pit may not be working properly. Get fresh air at once! Have the Fire Pit serviced. Some people are more affected by carbon monoxide than others, including pregnant women, people with heart or lung disease or anemia, those under the influence of alcohol, and those at high altitudes.

NATURAL GAS AND PROPANE:

To assist in detecting leaks, an odorant has been added to natural gas and propane. However, this odorant can fade, and gas may be present even though no odor exists.

WARRANTY REQUIREMENT:

When not in use, appliance must be covered at all times. Failure to cover the fire feature will void the warranty.

WARNING: Any modification to this appliance or its controls can be dangerous.

1. This appliance, as supplied, is only for use with the type of gas indicated on the rating plate.
2. When this appliance is connected to a fixed piping system, the installation must conform with local codes or, in the absence of local codes, with the National Fuel Gas Code, ANSI Z223.1/NFPA 54; National Fuel Gas Code, National Gas and Propane Installation Code, CSA B149.1; or Propane Storage and Handling Code, CSA B149.2 as applicable.
3. Keep the appliance area clear and free from combustible materials, gasoline and other flammable vapors and liquids
4. Do not burn solid fuel in this appliance. Do not use this appliance to cook food or to burn paper or other objects.
5. Children and adults should be alerted to the hazards of high surface temperatures and should stay away to avoid burns or clothing ignition.
6. Clothing or other flammable materials should not be hung from the appliance, or placed on or near the appliance.
7. Young children should be carefully supervised when they are in the area of the appliance.
8. Do not use the appliance if any part has been under water. Immediately call a qualified service technician to inspect the appliance and to replace any part of the control system and any gas control which has been under water.
9. Inspect the appliance before each use. If your firepit uses a hose inspect the hose before each use. If there is evidence of excessive abrasion or wear, or if the hose is damaged it must be replaced. Contact Dreamcast for a replacement.

WARNING: DO NOT USE OXYGEN MIXERS WITH YOUR DREAMCAST APPLIANCE. Mixers may create leakage in the cavity of the pit and could cause fire or explosion which could cause property damage, personal injury, or death.

Turn the appliance off and let cool before servicing, installing, repairing or covering. Any guard or other protective device removed for servicing the appliance must be replaced prior to operating the appliance. Only a qualified service person should install, service, or repair the appliance.

HIGH ALTITUDE INSTALLATION

Gas fireplaces are tested and approved for elevations from 0 to 4,500 feet in Canada and U.S.A. When installing this fireplace at an elevation above 4,500 feet (in Canada), check with local authorities. Consult your local gas utility for assistance in determining the proper orifice for your location.

LOCAL CODES

Install and use your Outdoor Fire Pit with care. Follow local codes. In the absence of local codes, use the latest edition of The National Fuel Gas Code ANSI Z223.1/NFPA 54 available from:

American National Standards Institute Inc.
1430 Broadway New York NY 10018
National Fire Protection Association, Inc.
Batterymarch Park Quincy MA 02269.

DreamCast is not responsible for damage due to improperly installed or operated units. Instructions are updated as needed, and it is the installer or owners' responsibility to periodically review DreamCast's website for applicable updates (www.dreamcastdesign.com.)

Please keep this manual with your important papers.

Your DreamCast Concrete Firepit

This Owner's Guide and Instruction Manual contains critical information for the safe installation operation and maintenance of your DreamCast fire feature. You must read this manual in its entirety prior to installation and/or operation.

UNBOXING

Upon receiving your DreamCast Firepit, take care to check all parts have been received according to the included packing slip.

ATTENTION: Fragile! Concrete may chip or scratch if collided with other hard materials such as stone, metal, or other concrete. HANDLE WITH CARE!

Remove the concrete parts from the crate, unwrap and place them on a soft surface. Take care when handling concrete parts as concrete is brittle and can chip or flake if struck. Inspect all parts for shipping damage. Any shipping damage must be reported immediately. We allow for 48 hours after receipt for any shipping damage to be claimed under warranty. Please contact DreamCast Design if you are missing any parts.

SET-UP

Before placing your DreamCast Firepit, check that the desired location meets all clearances to combustibles listed in the Fire Pit Clearances Diagram. Ensure that the final location for the fire pit is as flat and level as possible. Make sure to provide adequate drainage beneath the opening in the base of the fire pit body.

Carefully lift the fire pit or fire pit base and place it in its final position. If there is a gas riser, fire pit should be placed so that the stub is enclosed within the fire pit.

If the fire pit does not sit level, shim appropriately so that it is level and evenly supported. If the fire pit has a top section, carefully lift and place it on top of its base. Ensure that the provided rubber shims are installed between the top and base. Check that the top section is level and stable. If it does not sit level or is unstable, shim as required with additional rubber shims.

Follow the assembly instructions in this manual to connect the burner assembly, test for gas leaks, and place decorative burner media.

CONCRETE CARE

Your new DreamCast fire pit is factory sealed to resist staining and discoloration. However, care should be taken to maintain the premium concrete finish.

Concrete is a very porous material and may stain from certain substances left on the surface. Things that may stain if not removed include red wine, acidic juices, oils and waxes, tree sap and other organic material. Additionally, water trapped under an object for an extended period can leave a watermark.

We strongly recommend covering your firepit with a breathable, weather resistant cover when not in use.

MAINTENANCE

Your concrete fire pit can be cleaned with a soft cloth and mild soap to remove dirt and scuffs.

The surface can be periodically cleaned and refreshed with our DreamCast Refresh Sealer. Please contact us for more information and to order Refresh Sealer.

Scratches and chips can be repaired with our patch kit, though any repairs made to concrete will be visible.

CAUTION - HEAVY

Use care when lifting and placing to avoid injury and damage to property and the fire pit itself.

Fire pits will require 2 or more people to lift.

Applicable Models

This Owner's Guide and Instruction Manual is applicable to the following fire pit models. Specified hourly BTU inputs for each model.

| MODEL: | BTU INPUT (NG): | BTU INPUT (LP): |
|------------------|-----------------|-----------------|
| AURA36-CFB60 | 85,000 BTU | 62,000 BTU |
| AURA48-CFB60 | 85,000 BTU | 62,000 BTU |
| AURA48-CFB120 | 130,000 BTU | 110,000 BTU |
| AURA48-CFB180 | 165,000 BTU | 160,000 BTU |
| BLOQ-CFB60 | 85,000 BTU | 62,000 BTU |
| CUBO-CFB60 | 85,000 BTU | 62,000 BTU |
| ELEMENT36-CFB60 | 85,000 BTU | 62,000 BTU |
| ELEMENT48-CFB60 | 85,000 BTU | 62,000 BTU |
| ELEMENT48-CFB120 | 130,000 BTU | 110,000 BTU |
| ELEMENT48-CFB180 | 165,000 BTU | 160,000 BTU |
| LIBRA48-CFB60 | 85,000 BTU | 62,000 BTU |
| LIBRA60-CFB60 | 85,000 BTU | 62,000 BTU |
| LIBRA60-CFB120 | 130,000 BTU | 110,000 BTU |
| LIBRA60-CFB180 | 165,000 BTU | 160,000 BTU |
| LIBRA72-CFB60 | 85,000 BTU | 62,000 BTU |
| LIBRA72-CFB120 | 130,000 BTU | 110,000 BTU |
| LIBRA72-CFB180 | 165,000 BTU | 160,000 BTU |
| LINEA48-CFBL110 | 155,000 BTU | 135,000 BTU |
| LINEA60-CFBL190 | 180,000 BTU | 190,000 BTU |
| LINEA72-CFBL250 | 275,000 BTU | 245,000 BTU |

| MODEL: | BTU INPUT (NG): | BTU INPUT (LP): |
|-------------------|-----------------|-----------------|
| LOTUS32-CFB60 | 85,000 BTU | 62,000 BTU |
| LOTUS45-CFB60 | 85,000 BTU | 62,000 BTU |
| LOTUS45-CFB120 | 130,000 BTU | 110,000 BTU |
| LOTUS45-CFB180 | 165,000 BTU | 160,000 BTU |
| PHANTOM48-CFBL150 | 160,000 BTU | 160,000 BTU |
| PHANTOM60-CFBL210 | 215,000 BTU | 215,000 BTU |
| PHANTOM72-CFBL250 | 275,000 BTU | 245,000 BTU |
| QUADRA48-CFBL110 | 155,000 BTU | 135,000 BTU |
| QUADRA60-CFBL150 | 160,000 BTU | 160,000 BTU |
| QUADRA72-CFBL210 | 215,000 BTU | 215,000 BTU |
| QUADRA84-CFBL250 | 275,000 BTU | 245,000 BTU |
| ZEN34-CFB60 | 85,000 BTU | 62,000 BTU |
| ZEN34-CFB120 | 130,000 BTU | 110,000 BTU |
| ZEN34-CFB180 | 165,000 BTU | 160,000 BTU |
| ZEN36-CFB60 | 85,000 BTU | 62,000 BTU |
| ZEN36-CFB120 | 130,000 BTU | 110,000 BTU |
| ZEN36-CFB180 | 165,000 BTU | 160,000 BTU |
| ZEN48-CFB60 | 85,000 BTU | 62,000 BTU |
| ZEN48-CFB120 | 130,000 BTU | 110,000 BTU |
| ZEN48-CFB180 | 165,000 BTU | 160,000 BTU |

Minimum and Maximum

Gas Inlet Pressures

The installer is responsible for using the correct fuel lines and/or regulation to provide gas to the fire feature within the specified minimum and maximum gas inlet pressures below:

| | Minimum | Maximum |
|----------------|----------------------------|----------------------------|
| Natural Gas | 7.0" W.C. (1.7436 Kpa) | 10.0" W.C. (2.4884 Kpa) |
| Liquid Propane | 11.0" W.C. (2.7399 Kpa) | 13.0" W.C. (3.2381 Kpa) |

CODE REQUIREMENTS

It is the responsibility of the installer to consult with the local municipality and to FOLLOW ALL LOCAL CODES concerning the installation and operation of the fire feature.

GENERAL INSTALLATION INSTRUCTIONS

Use only joint compound, thread sealant, or tape specific to gas use that is resistant to all gases. Apply joint compound, thread sealant or tape to all male pipe fittings only and **DO NOT USE ON FLARED END OF FLARED FITTINGS**. Be sure to tighten every joint securely. If you are lighting manually be sure to maintain a minimum safe distance to avoid property damage, personal injury, or death. Please refer to match lit instructions:

1. Verify gas supply matches burner & pilot type.
2. Verify gas inlet pressure is within the specified minimum and maximum pressures. Consult Gas Inlet Pressures on previous page.
3. Purge gas lines of air, water and debris.
4. Perform all leak tests with leak detector or leak reactant on main gas supply and repair leaks as necessary. Turn off gas supply.

5. For models that include electronic ignitions, be sure to have a qualified electrician install proper power supply following all local codes.

6. Inspect flex line(s) for punctures or breaks in line(s).

7. Make sure the control knob turns the control valve before installing. Use only your hand to turn the control knob. Never use tools. If the control knob will not turn by hand, don't try to repair it. Force or attempted repair may cause a fire or explosion.

8. Refer to Connection Diagrams for applicable gas connections.

9. Position burner safely with access to all gas connections for testing. Position burner to allow sufficient clearance from the fire pit to avoid damage.

10. Turn on gas supply to perform repeat leak tests on main gas supply and all connections to appliance and repair as needed.

11. Do not use appliance if there is evidence of leaking gas. If leak is suspected, turn off main gas supply immediately. For appliances for use with a fixed fuel piping system and equipped with an appliance gas pressure regulator, the appliance and its individual shutoff valve must be disconnected from the gas supply piping system during any pressure testing of that system at test pressure in excess of ½ psi (3.5kPa). The appliance must be isolated from the gas supply piping system by closing its individual manual shutoff valve during any pressure testing of the gas supply piping system at test pressures equal to or less than ½ psi (3.5 kPa).

12. Ignite burner. See applicable ignition instructions within Operating Instructions, page 15.

13. Once appliance is lit, perform leak test on all gas connections and repair as needed.

14. Turn off appliance and allow to cool.

GENERAL INSTALLATION INSTRUCTIONS Cont.

15. DreamCast Fire Pit must be installed on a stable surface. Fire pit must be properly assembled, level, and stable. The weight of the burner and media must be supported by the aluminum support plate and not by any control box or gas valve. Control boxes and gas valves must be above grade with adequate drainage to prevent water damage. Installer is responsible for making sure there is enough space in the cavity for any electronics and piping.

The lower cavity of the enclosure cannot be filled with any material (i.e. gravel, crushed rock, concrete, etc). The fire pit burner assembly should be recessed from the top of the enclosure to protect flame from excessive wind and to allow coverage of burner. **See Clearances Diagram on page 6.** To allow for regular maintenance, nothing should be attached to the firepit that would prevent removal of the support pan and burner assembly.

16. Venting is required to avoid heat damage to internal components and to allow airflow in case of gas pooling. Do not block the integral vents in your DreamCast Firepit with any material.

17. Only use fire rated media approved for use with high temperatures that have been manufactured for specific use in fire features. Never use any material for media that is nonporous and holds moisture such as gravel, pebbles, river rock, etc. Such material, when heated, may cause the trapped moisture to boil, fracture unexpectedly and/or explode and which could cause personal injury, damage or death.

18. To avoid dust and clogs getting into the system, do not dump the media over the burner. Place the media onto the plate or pan. **Burner should be covered by approved media up to 1/2" above the jets. Media may be positioned so that jet tips or barrels are visible. Excessive media coverage may cause back pressure and dangerous pooling of gas which can result in explosion which could cause property damage, personal injury, or death.**

19. Do not cover the ignition pilot assembly or wind cage more than halfway with any form of media.

20. Complete final verification of correct operation and lighting.

21. Review instruction manual with end user and instruct end user not to change/modify fire pit or media in any way that may affect pilot assembly or wind cage.

 **WARNING:** Do not store or use gasoline, or other flammable vapors and liquids, in the vicinity of this or any other appliances.

An LP-cylinder not connected for use shall not be stored in the vicinity of this or any other appliance.

 **WARNING:** Improper installation, adjustment alteration, service or maintenance can cause property damage, personal injury or loss of life. Refer to the owner's information manual provided with this appliance. Installation and service must be performed by a qualified installer, service agency, or the gas supplier.

LOCATION CONSIDERATIONS

All appliances are designed and intended for outdoor use only.

All appliances must have a gas shutoff located outside of the appliance to allow for emergency shutoff and maintenance. Select a location where the appliance can be attended during operation. Never leave an operating appliance unattended or by someone not familiar with its operation or emergency shutoff locations.

Appliances may create very high temperatures - combustibles must be located far enough away that there is no risk of ignition.

IMPORTANT: It is recommended that material such as granite, marble or other dense stone be kept an appropriate distance away from flame due to risk of cracking. Manufacturer is not responsible for damage to any nearby material for any reason.

FIRE PIT CLEARANCE TO COMBUSTIBLES see fig. 1 & fig. 2

- Square/Round Fire Pits / Linear Fire Pits Short Side Clearance:
36" from any combustible structure or materials.
- Linear Fire Pits **Long Side** Clearance:
48" from any combustible structure or materials.
- All Fire Pits - Overhead Clearance:
There must be **NO** combustible materials above the firepit.
- Choose a location that allows easy access for installation and maintenance of the fire pit.
- Pick a location that allows sufficient horizontal room to enjoy the appliance while allowing a safe distance from the heat and flame.
- Always consult with local municipality regarding any local code requirements.

The fire pit must be placed on a stable surface and must be level.

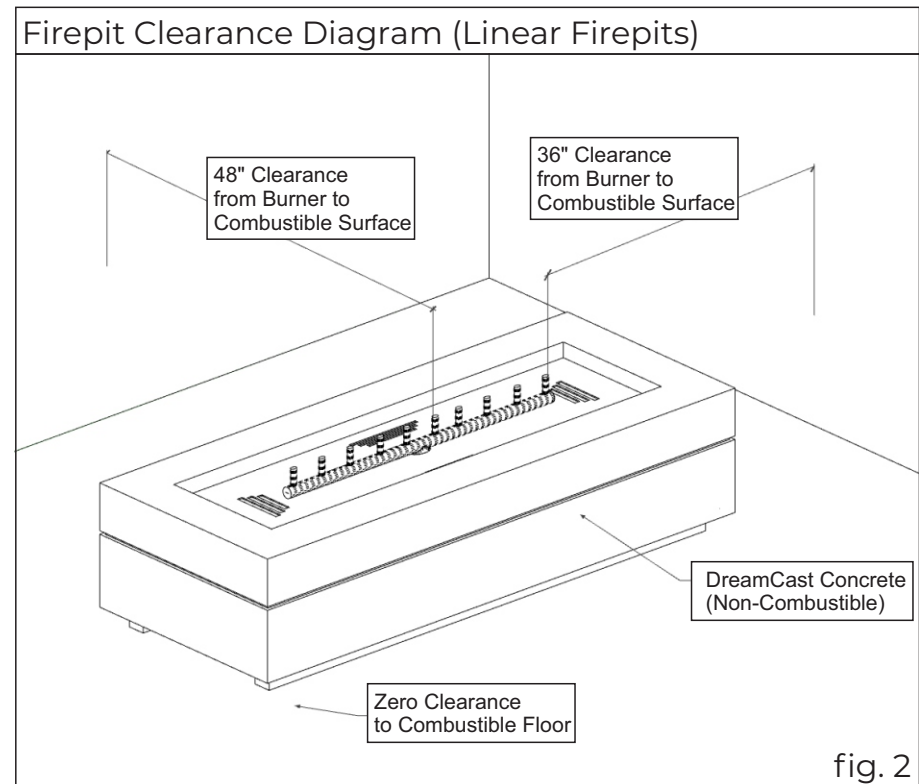
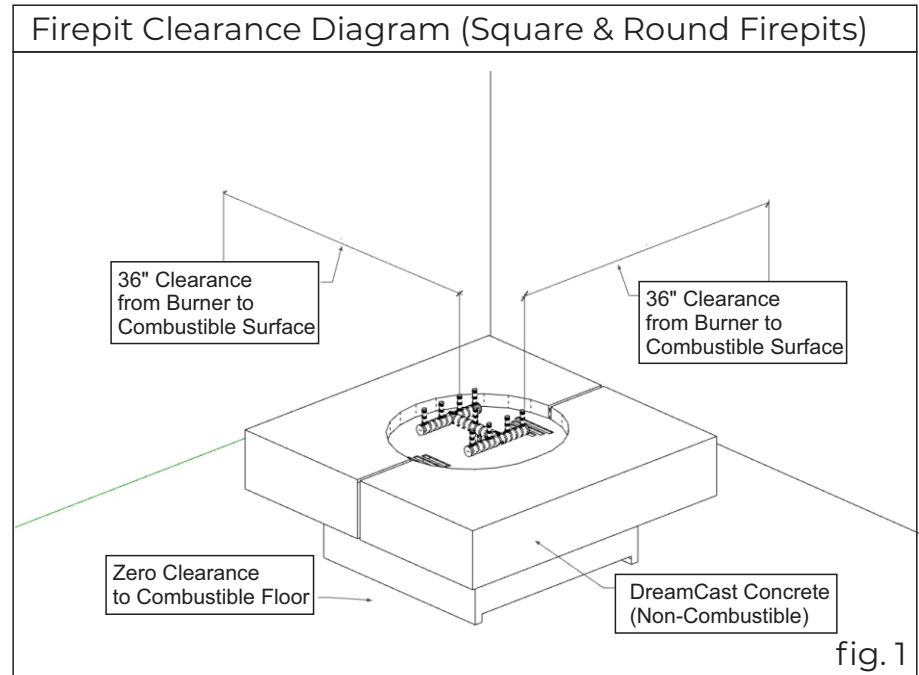

POSITIONING GAS SUPPLY

All DreamCast round Fire Bowls have a minimum 5" diameter opening in the base through which you can bring a gas or propane line. Side openings are also present at 1.5" diameter to allow for above-grade gas line access.

Please make sure that the gas line is located only within this area. This will ensure that the final position of the unit will not be compromised.

Refer to the assembly diagram for your specific model for more details.

We recommend that gas risers be kept as low to grade as possible and no higher than 6" at their highest points so as not to interfere with the internal components of the firepit.

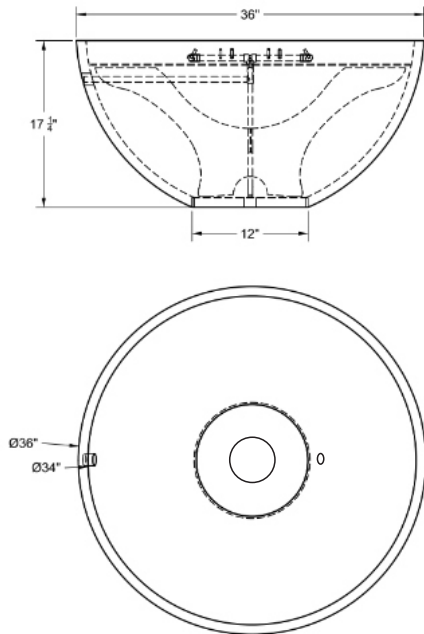

Example:
Zen 36
Fire Bowl

All DreamCast square/rectangular Fire Pits have a hollow base.

Gas supply can come up within the footprint of this hollow base. Side slots are inherent on two sides to allow for above-grade gas line access & ventilation.

Please make sure that the gas line is located only within this area. This will ensure that the final position of the unit will not be compromised.

ATTENTION:

Gas line must be installed by a licensed contractor in compliance with local codes.

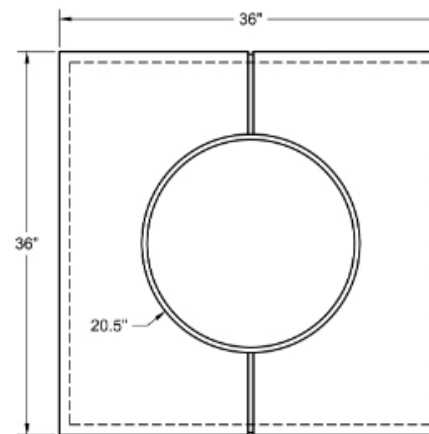
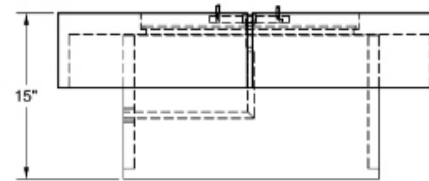

Example:
Element 36
Fire Table

Assembly Instructions - Overview

⚠ **WARNING**

Failure to position parts in accordance with these diagrams and instructions and/or failure to use parts specifically approved for use with this appliance may result in property damage or personal injury.

⚠ **CAUTION**

Do not remove the data plate attached to the Concrete Fire Pit. This plate contains important information.

NOTICE

Installation and repair should be done by a qualified service person. The appliance should be inspected before use and at least once annually by a qualified service person. More frequent cleaning may be required as necessary. It is imperative that controls, burner and circulating air passageways of the appliance be kept clean.

1. Position Fire Pit

Position concrete fire pit according to the Clearance Requirements and Gas Supply location on pages 7 & 8.

2. Identify Parts & Assembly

Identify all parts on the Parts List on page 10 and familiarize yourself with the assembly diagram for your fire pit.

3. Assemble Fire Pit

Follow the assembly instructions on the following pages.

4. Leak Test

Carefully leak test all connections.

5. Lighting Test

Test lighting of the firepit, following the operating instructions on page 15-16 and observe the flame pattern of the pilot and burner.

6. Install Fire Pit Media

Follow the instructions on Page 14.

7. Final Test

Test once more to ensure that the media installation has not affected the burner operation.

Assembly Instructions - Parts List

1. Concrete Firepit (Varies by model)
2. Aluminum Support Plate (Varies by model)
+ Aluminum Stand (Zen 36 Only)
3. Gas Burner (NG or LP) (Varies by model)
4. Split-Ring Pipe Clamp (qty. 2)
5. Fire Pit Media (Lava Rock)
6. Pilot Assembly (NG or LP)
7. Pilot Mounting Bracket
8. Control Valve Mounting Plate
9. Control Knob
10. Control Valve
11. Street Elbow 1/2" (qty. 2)

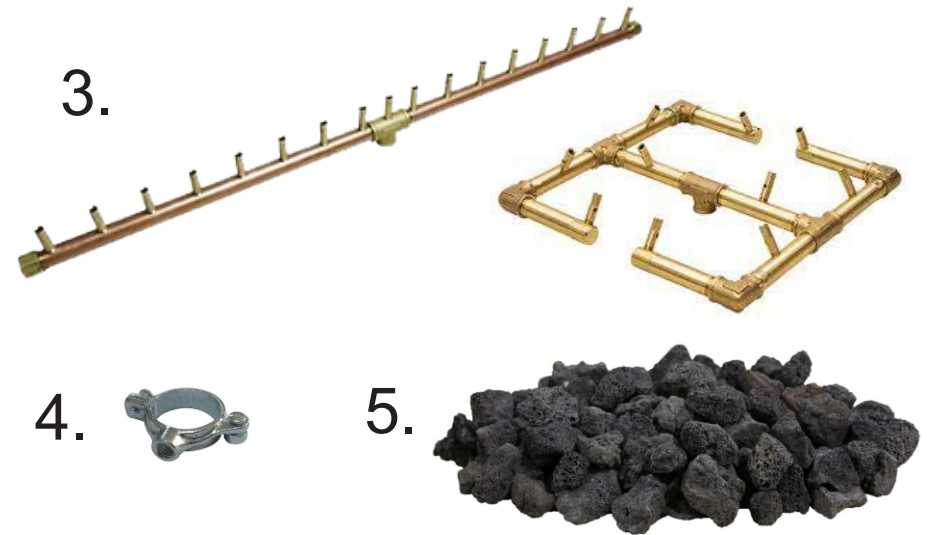

- 50k-199k BTU SYSTEMS:**
12. Flex Hose 1/2" (qty. 2)
(inc. 1/2"x1/2" Flare x MIP fittings)

- 200k-250k BTU SYSTEMS:**
13. Flex Hose 3/4" (qty. 2)
(inc. 3/4"x3/4" Flare x MIP fittings)
 14. Nipple 1/2" (qty. 3)

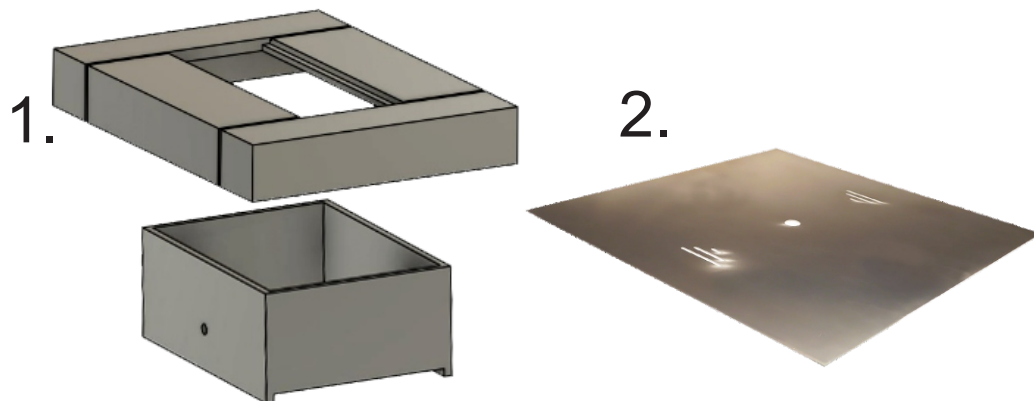
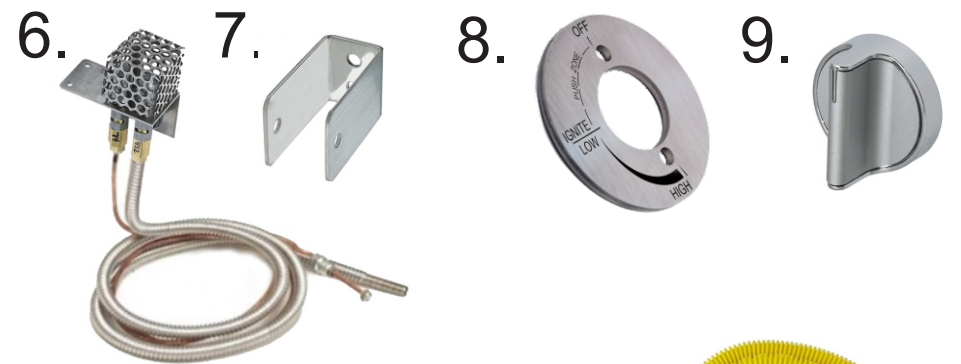

Assembly Instructions

1. Identify All Components

Locate and identify all the components on the parts list.

Remove the 4x flared fittings from the Flex Hoses.

1/2" Hoses



3/4" Hoses



Put them aside, you will need them.

2. Attach Burner Fittings

50k-199k BTU SYSTEMS:

Install one flared fitting into the burner inlet.



-OR-

200k-250k BTU SYSTEMS:

Install one 1/2" Nipple into the burner inlet, then install one flared fitting onto the 1/2" nipple.



3. Mount Burner to Support Plate

Attach Pipe Clamps (4) to Aluminum Plate (2) using the supplied bolts.

Use Pipe Clamps to mount Burner to Aluminum Plate.

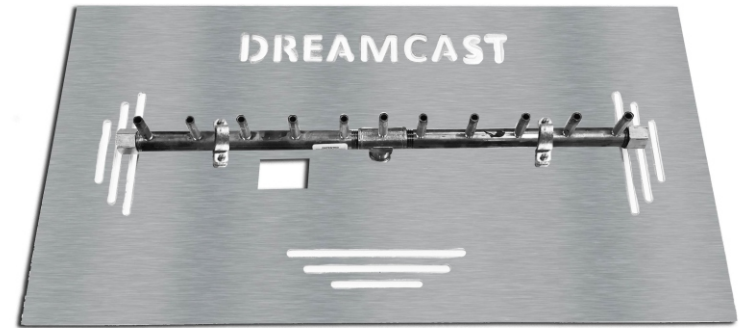

4. Mount Pilot Assembly to Support Plate

Attach the Pilot Mounting Bracket to the Pilot Assembly using the supplied bolts.

Feed the Thermocouple cable and Pilot line through the opening in the Aluminum Plate.

Secure the Pilot assembly to the Aluminum Plate using the supplied bolts.



Assembly Instructions

4. Assemble The Control Valve

Install the 2x street elbow fittings into the Control Valve so that they are oriented in the same direction as the pilot and thermocouple ports.

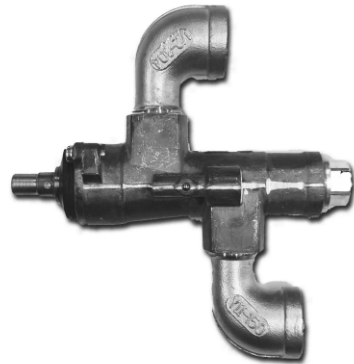

50k-199k BTU SYSTEMS:
Install one flared fitting into the each street elbow.



-OR-

200k-250k BTU SYSTEMS:
Install one 1/2" Nipple into each street elbow, then install one flared fitting onto each 1/2" nipple.

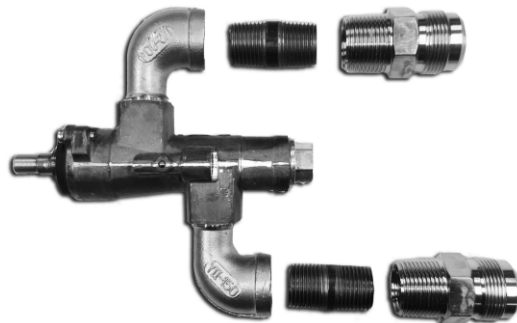

5. Mount Control Valve onto Fire Pit

Attach the Control Valve Mounting Plate to the outside of the firepit using the supplied bolts and backing plate.

Ensure the printed markings on the mounting plate are oriented correctly.

Remove the threaded nut from the front of the Control Valve. Place the Control Valve inside the firepit, through the mounting plate, and secure it with the threaded nut.

Ensure that the Pilot Adjustment valve is on top and can be accessed from the outside, through the hole in the mounting plate.

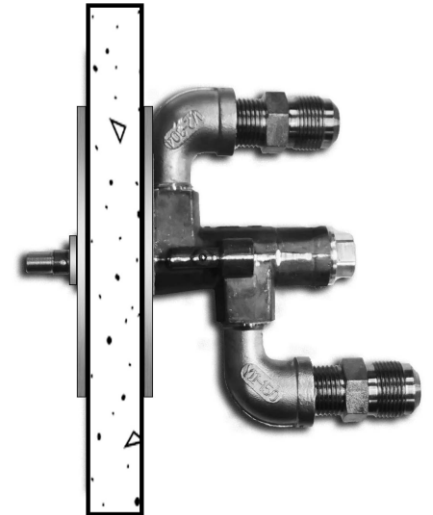

6. Connect Control Valve to Gas Supply

Install the two Flex Hoses onto the two flared fittings that are installed on the Control Valve.

Connect your gas supply to the inlet side of the Control Valve.

DreamCast High-BTU fire pits are not certified for use with portable propane tanks. They must be connected to a fixed fuel piping system.

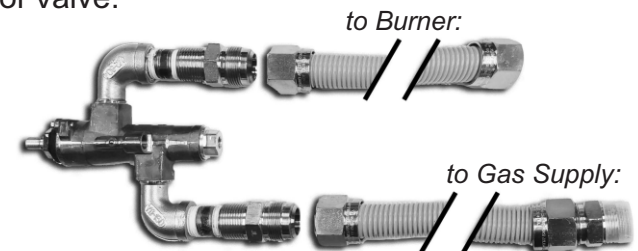

Assembly Instructions

7. Connect Control Valve to Burner Assembly

Place the aluminum plate on a blanket, or have someone hold it, in a position where the remaining connections can be made.

A) Connect the flex hose from the Control Valve burner outlet to the flared fitting on the Burner inlet.

B) Connect the Thermocouple Line from the Pilot Assembly to the Control Valve thermocouple port.

C) Connect the Pilot Line from the Pilot Assembly to the Control Valve pilot outlet.

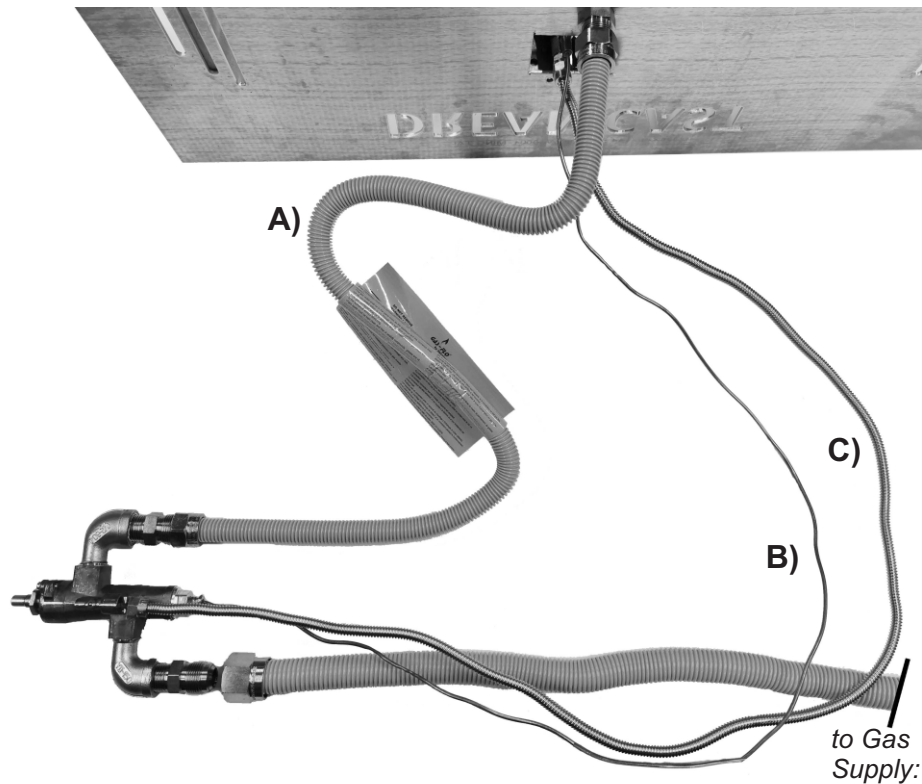

Carefully lower the Aluminum Plate Assembly into the firepit, taking care not to kink or crush any of the lines.

8. Test the Assembly

Check all connections for leaks with leak detector or leak reactant on main gas supply and repair leaks as necessary.

Light the fire pit following the instructions in “**Operating Instructions**” on page 15.

Visually inspect the Pilot flame. Pilot flame should cover the thermocouple by 3/8" to 1/2". Adjust as necessary.

Visually inspect Burner flame pattern. Flames should be steady and consistent throughout the burner.

Typical Flame Patterns:

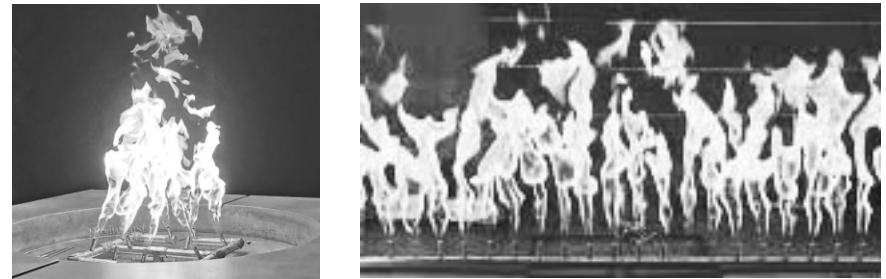

Refer to the “**Troubleshooting Guide**” on page 16 to resolve any issues.

9. Install the Firepit Media

Install the Firepit Media following the instructions in “**Media Installation**” on page 12.

Test the fire pit one more time after installing the media.

⚠️ WARNING: Test all gas piping and connections for leaks after installing or servicing. Correct all leaks immediately.

Assembly Instructions - Media Installation

⚠ WARNING: Covering jets by more than 1/2" of media may create back pressure and gas leakage resulting in pooling of gas under the fire feature which can result in explosion which could cause property damage, personal injury, or death.

Only use approved decorative media (glass, lava rock, ceramic log sets, etc.) that have been manufactured for specific use in fire features.

Media must be 1/2" or larger in size to prevent media from falling into gas orifices and blocking flow of gas out of jets. Use approved media only. To avoid dust and clogs getting into the system, do not dump the media over the burner.

Place the media onto the plate or pan.

Burner should be covered by approved media up to 1/2" above the jets. Media may be positioned so that jet tips or barrels are visible.

Also note that flame pattern will be affected by any media coverage over gas orifice jets up to and including smothering of flames. The appliance is designed to use approved media that is correctly installed over the burner to achieve proper combustion. Use of any media outside of the approved media may void warranty and affect proper operations.

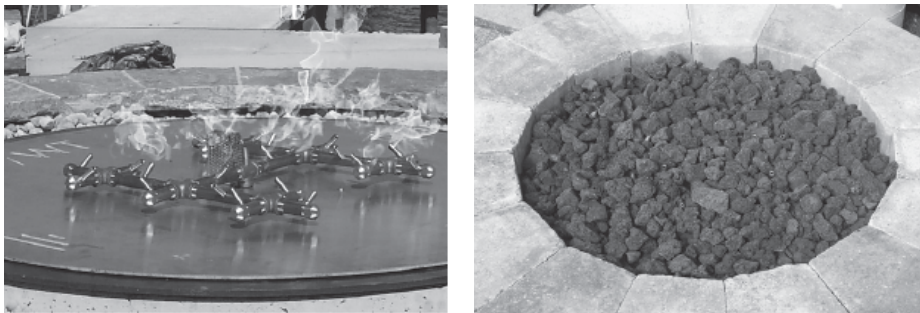

Properly installed burner before and after media installation.

DO NOT DUMP MEDIA ON THE JETS.

Apply media by pouring media around burner first, then pushing media towards the gas jet orifices making sure media does not fall into the gas jet orifices. Check each gas jet orifice prior to lighting to be sure no media has fallen into gas jet orifices.

Keep pilot assembly screen free and clear of all media. Media should be piled no more than halfway up screen only (not over full amount of screen) so that pilot gas orifice opening is above media coverage allowing for pilot flame to easily reach gas jet orifice.

Properly installed media around pilot assembly.

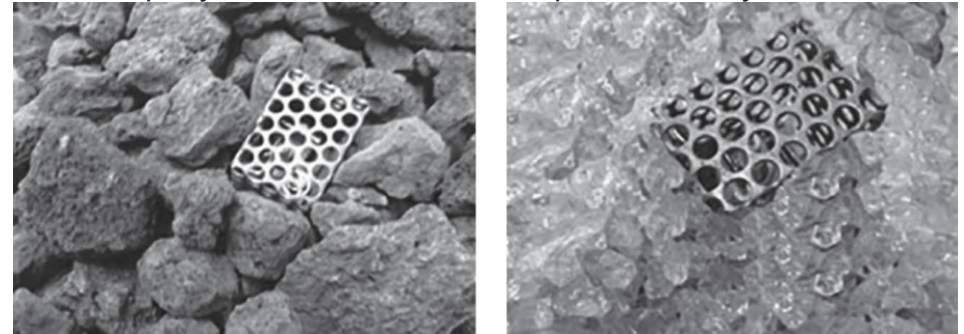

Log Sets & Other Decorative Media:

Place decorative media on top of lava rock or media base according to preference and desired flame pattern. **Do not block, cover or obstruct pilot assembly.** Blocking, covering or placing ceramic logs or other decorative media too close to pilot may cause excessive heat on pilot causing system to fail. This is not covered under warranty.

CAUTION:

When lava rock is new or contains moisture, operating the fire pit may cause the lava rock to pop and cause small particles to fly. When igniting the fire pit for the first time, or after lava has become damp, it may take several minutes for the lava to dry out and cease popping.

Operating Instructions

Important Considerations:

Keep the area clear and free from combustible materials, gasoline, and other flammable vapors and liquids. Solid fuels shall not be burned in the fire pit. Leaves, sticks, wood, paper, clothing, food material, should be kept away from the fire pit.

Make sure that there is no vegetation or other objects over the top or sides of the fire pit that could interfere with safe operation. If there are any questions as to clearances, refer to the **CLEARANCES DIAGRAM** in this manual for specific clearance allowances.

Wind and gusty conditions may cause the flame to behave in an unpredictable manner. If such conditions exist, turn off the fire feature.

All media has the potential of thermal spalling. This process may occur when media is wet and moisture gets trapped inside of the material due to rapid temperature differences. When this happens the media has the potential to crack or pop outside of the firepit. Extra caution should be taken when lighting in high humidity or moisture. After lighting, allow 30 minutes to dry out the media until all popping has ceased before enjoying the fire.

⚠ WARNING: Fire or Explosion Hazard.

If you smell gas, shut off gas to the appliance, extinguish any open flame. If odor continues, leave the area immediately. After leaving the area, call your gas supplier or fire department. Failure to follow these instructions could result in fire or explosion, which could cause property damage, personal injury or death.

⚠ WARNING: Failure to follow these instructions could result in fire or explosion, which could cause property damage, personal injury or death.

HOW TO TURN ON YOUR FIREPIT

STOP! Read all the safety information.

1. Any cover must be removed prior to operation of the firepit and must remain off during operation and after operation until the firepit has cooled.
2. Locate the control knob on the firepit and confirm it is in the "Off" position.
3. Locate the main gas control valve controlling Natural Gas or Liquid Propane supply to the fire pit and confirm it is open.
4. Before lighting, visually inspect the firepit and remove any leaves or other debris.

LIGHTING THE PILOT

1. Locate the control knob and pilot light on the firepit, and ensure you can reach the pilot light with your barbecue lighter.
2. Gently press the control knob, and turn it 90° counterclockwise to the "Pilot" position.

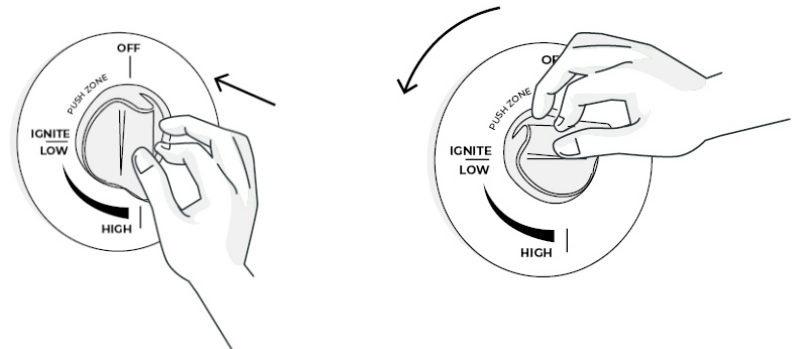

Operating Instructions

3. Push in the control knob, which will send gas to the pilot light.

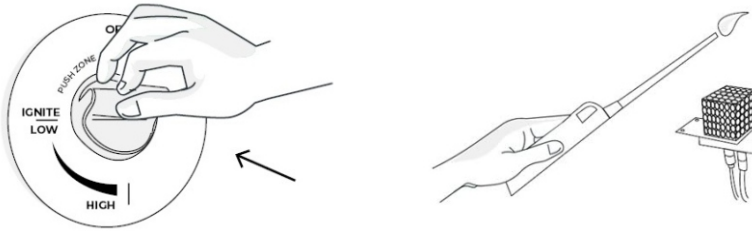

4. While still pushing in the control knob, ignite the pilot light using your barbecue lighter.

Depending on how long it has been since the fire pit was last used, ignition may take multiple attempts until air is purged from the system.

5. After the pilot lights, keep the control knob pushed in about 20 to 30 seconds to warm up the thermocouple and ensure that the flame stays lit.

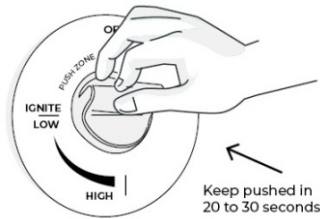

In exceptionally cold or wet conditions, the thermocouple can require additional time to reach the required temperature.

6. Release the control knob. If the pilot does not remain lit, wait 5 minutes, then repeat steps 2 to 6 of the ignition process.

If the pilot will not light after multiple attempts, refer to the troubleshooting guide on page 16.

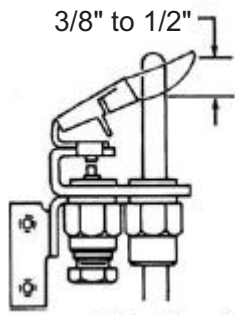

Pilot Flame Check:

The pilot flame should envelop the thermocouple tip by 3/8" to 1/2".

The pilot flame should be mostly blue and burning smoothly. If the flame is yellow, flickering or waving, excessively large or too small, turn off the fire pit and consult the troubleshooting guide.

⚠ WARNING: Failure to follow these instructions could result in fire or explosion, which could cause property damage, personal injury or death.

LIGHTING THE MAIN BURNER

1. Rotate the control knob slowly towards the "On" position to light the fire pit.

If the main burner does not light or the flames are irregular, turn the control knob to the "Off" position and refer to the troubleshooting guide on page 20.

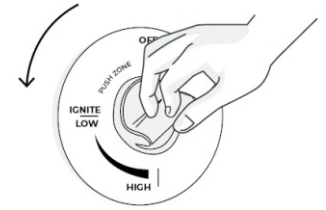

2. The flame height can be adjusted during operation of the fire pit by adjusting the control knob between the "Pilot" and "On" positions.

HOW TO TURN OFF YOUR FIRE PIT

1. Rotate the control knob to the "Pilot" position to turn off the main burner.

CAUTION: THE PILOT WILL REMAIN LIT IN THIS POSITION

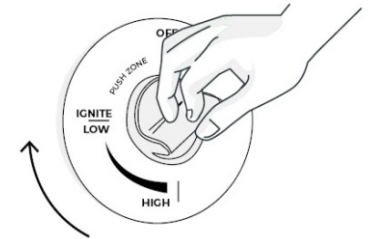

DO NOT COVER THE FIRE PIT WHILE THE PILOT IS LIT.

2. Rotate the control knob to the "Off" position to completely turn off the fire pit.

3. Close the main gas control valve to the fire pit.

After turning off the fire pit, allow a 5 minute shut-down period before relighting.

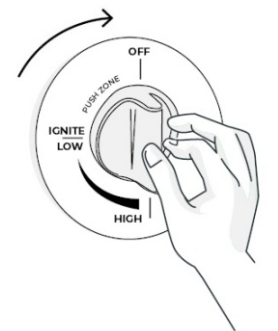

ALLOW THE FIRE PIT TO COOL COMPLETELY BEFORE COVERING WITH ANY COVER.

Troubleshooting Guide

⚠ WARNING: If you smell gas, shut off gas to the appliance, extinguish any open flame. If odor continues, leave the area immediately. After leaving the area, call your gas supplier or fire department. Gas leaks to be corrected by a qualified technician.

Below are some potential causes and countermeasures to the symptoms listed: **TURN OFF APPLIANCE BEFORE SERVICE**

| PROBLEM | POSSIBLE CAUSE | SOLUTION |
|--|--|---|
| Pilot Will Not Light | <i>(Note: In bright daylight, it may simply be difficult to see the Pilot Light. Make sure there is no heat coming off the pilot to be certain it has not lit.)</i> | |
| | Insufficient Gas Flow | <ul style="list-style-type: none"> - Confirm main gas control valve is open. - Confirm that any installed secondary control valves are open. - Confirm gas pressure is within required ranges (See Page 4). - (LP System Only) Check Liquid Propane tank is not empty. - (LP System Only) Check regulator for damage or improper installation. - (LP System Only) Fire pit valve must be OFF when tank is turned ON. Turn tank valve ON slowly to allow pressure to equalize. |
| | Air In System | Depending on the length of gas line and time since last use, it may take a few minutes of gas flow for the system to purge all air and allow ignition. |
| | Insufficient Gas Flow To Pilot | There is a pilot adjustment valve behind the control knob. Using a small flat-head screwdriver, turn the pilot valve counterclockwise to increase gas flow to the pilot. This should be kept at the minimum level required for operation of the appliance. |
| | Faulty Assembly | If you are still cannot light the pilot or burner, the system may be incorrectly assembled or faulty. Please consult a qualified technician. |
| Main Burner Will Not Light | <i>(Note: After lighting the pilot, try to light the main burner with a barbecue lighter. If it lights then the issue is likely with the pilot. If not, then the issue is likely with the burner.)</i> | |
| | Media Obstruction | Rearrange firepit media to ensure there is clear flow between the pilot and the nearest burner ports. |
| | Weak Pilot Flame | See (Insufficient Gas Flow To Pilot) above. |
| | Insufficient Gas Flow | See (Insufficient Gas Flow) above. |
| | Faulty Assembly | See (Faulty Assembly) above. |
| One or More Flame Jets Will Not Light | Blocked Jets | Clean the burner orifices and check jets for obstructions. Rearrange firepit media to ensure there is clear gas flow from the jets. |

Troubleshooting Guide (cont.) & General Maintenance

| PROBLEM | POSSIBLE CAUSE | SOLUTION |
|--|---|---|
| Low flame when turned to High | Insufficient Gas Pressure | <ul style="list-style-type: none"> - Confirm gas pressure is within required ranges (Page 4). - (LP System Only) Check Liquid Propane tank is not empty. - (LP System Only) Check regulator for damage or improper installation. - (LP System Only) Fire pit valve must be OFF when tank is turned ON. Turn tank valve ON slowly to allow pressure to equalize. |
| | Kinked Gas Lines | Relieve any tight bends or kinks in gas supply lines. |
| Excessive Soot or Smoke | <i>Note: It is natural and unavoidable for gas firepits to produce moderate levels of carbon (soot) where flames contact the media.</i> | |
| | Media Obstruction | Rearrange firepit media to ensure there is clear flow for the firepit flames. |
| | Foreign objects in Firepit | Liquid & food spills on the media, burner or firepit, debris in the firepit and the use of non-approved media can all cause excessive smoke or soot. Ensure the firepit & media are clean and free of debris when in use. |
| | Impurities in Gas Supply | Contact your local Gas Supply company for advice. |
| Burner is Excessively Noisy or Whistling | <i>(Note: The movement and combustion of gas will create low, unavoidable levels of noise.)</i> | |
| | Kinked Gas Lines | Relieve any tight bends or kinks in gas supply lines. |
| | Improper Gas Pressure | <ul style="list-style-type: none"> - Confirm gas pressure is within required range. - (LP System Only) Check regulator for damage or improper installation. |
| Contact a certified gas technician for service & repair if these suggestions do not solve the issue. | | |

General Maintenance

Any guard or protective device removed for servicing must be replaced prior to operating the appliance. Installation and repair should be done by a qualified technician. Appliances should be inspected prior to each use and inspected at least once annually by a qualified gas appliance service professional.

Ensure gas and power (if applicable) are shut off and fire pit is cool before servicing.

Keep fire feature covered at all times when not in use.

Keep any debris out of appliance - clean as needed. If debris is found, remove before lighting system.

JET ORIFICE CLEANING

Annual inspection and cleaning of the fire feature is recommended. If at any time the flames exhibit any abnormal shapes or behavior, or if burner fails to ignite properly, then the burner holes located in bottom of gas jet orifices may require cleaning. The appliance can be cleaned by carefully removing the logs and media to allow access to burner.

Use a brush to carefully remove dust, spider webs and loose particles. Periodical inspection by a qualified service technician of the air-intake is required to ensure your fire feature performs properly.

Use a wire or small puncture tool and carefully insert in jet. Tool should be size of a small paper clip. If evidence of damage is found, burner must be replaced with the appropriate burner specified by the manufacturer.

PILOT ASSEMBLY/THERMOCOUPLE CLEANING OF SOOT

The flames from the pilot should be visually checked as soon as the unit is installed, and periodically during normal operation. The pilot flame must always be present when the fire pit is in operation. The pilot flame has two distinct flames: one engulfing the thermocouple and the other reaching to the main burner.

Every six months or as needed, remove media, lava rock, or glass from around the pilot assembly. Clean the thermocouple of any soot using soft brush. Be careful not to damage the igniter element. Be sure when returning your media to the pit to cover your orifices to avoid blocking the jets as mentioned on page 6. Once pilot assembly is clean, inspect to see flame that covers 3/8" to 1/2" of the thermocouple. Cleaning of pilot gas orifice may be required by removing pilot hood and removing orifice and cleaning out orifices from debris, soot or anything that may be preventing gas flow from exiting the pilot gas orifice.

CONCRETE

Refer to Concrete Care & Maintenance Guide online at www.dreamcastdesign.com

⚠ WARNING: Fire feature should be inspected by user prior to each use and inspected at least once annually by a qualified gas appliance service professional

Prop. 65 Warning

What is “Prop 65”?

Proposition 65 (“Prop 65”) is a California law which requires businesses to provide warnings to Californians about significant exposures to chemicals that cause cancer, birth defects or other reproductive harm. These chemicals can be in the products that Californians purchase, in their homes or workplaces, or that are released into the environment. Prop 65 enables Californians to make informed decisions about their exposures to these chemicals.

Prop 65 also prohibits California businesses from knowingly discharging significant amounts of listed chemicals into sources of drinking water.

Prop 65 requires California to publish a list of chemicals known to cause cancer, birth defects or other reproductive harm. This list, which must be updated at least once a year, has grown to include approximately 900 chemicals since it was first published in 1987.

Prop 65 became law in November 1986, and is also known as the Safe Drinking Water and Toxic Enforcement Act of 1986. Prop 65 does not apply to products sold outside of the state of California. For more info on Prop 65, go to: www.p65warnings.ca.gov For a fully updated list of all the chemicals and compounds that are known to the State of California to cause cancer or reproductive toxicity, go to: <https://oehha.ca.gov/proposition-65/proposition-65-list>.

Warnings

WARNINGS:

Lead: Can cause birth defects or other reproductive harm. Lead can be found in brass fittings. View the fact sheet at www.p65warnings.ca.gov

Carbon Monoxide: Carbon monoxide is a colorless, odorless, and poisonous gas. It is formed during the combustion of various fuels. View the fact sheet at www.p65warnings.ca.gov

Bisphenol A: BPA is a widely used chemical that be found in linings, plastics, and other materials. It can cause harm to the female reproductive system. View the fact sheet at www.p65warnings.ca.gov

Furniture Product Exposure: Some furniture products can expose you to chemicals which are known to the State of California to cause cancer or birth defects or other reproductive harm. View the fact sheet at www.p65warnings.ca.gov

Want to see more? View all of the Prop 65 fact sheets at www.p65warnings.ca.gov

More Info on Prop 65

If you have specific questions on the administration or implementation of Proposition 65, you can contact OEHHHA’s Proposition 65 program at P65.Questions@oehha.ca.gov, or by phone at (916) 445-6900.

For enforcement information, contact the California Attorney General’s Office at (510) 622-2160, or visit <https://oag.ca.gov/prop65>.

Note: The information provided is for informational purposes only and does not constitute legal advice. If you have any concerns about Prop 65 or how it may apply to our products, please consult your attorney

DREAMCAST DESIGN AND PRODUCTION LTD. (“DreamCast”) LIMITED WARRANTY

CONCRETE FIRE PITS

Warranty and Limitations

1. For a period of one (1) year (the “Warranty Period”) commencing on the date of purchase by the Buyer of the Product from DreamCast, DreamCast hereby warrants that the Product shall be free from defects in materials and workmanship when used by the Buyer reasonably and in accordance with any manual, instructions, and guidelines prepared and distributed by DreamCast and generally accepted industry standards and practices (collectively, the “Warranty”).

2. For greater clarity:

a. surface, colour, and slight size variations are inherent in the Product; and natural variation in colour, texture, and porosity may occur in the Product, are considered inherent and valued qualities of the material, and shall not be covered under this Warranty;

b. DreamCast warrants against cracks and breaks in the Product resulting from structural defects only; non-structural hairline cracks occurring in the Product shall not be considered structural defects and shall not be covered under this Warranty; furthermore, chips and scratches shall not be covered under this Warranty;

c. all Products will mature and age over the course of time through natural processes associated with use, heat, and flame; these changes are an essential part of the dynamic of the Product, and shall not be covered under this Warranty;

d. damage to the Product resulting from excessive overloading, impact, or abnormal abrasion or use of the Product is not covered under this Warranty;

e. this Warranty shall expressly exclude damage to the Product occurring due to accident, act of god, fire exposure, contact with liquids, vandalism, ground movement, exposure to elements of nature, including, without limitation, salts, neglect, misuse, abuse, or other external effects on or of the Product;

f. damage to the Product caused by use with any third-party component, element, or product that does not meet the specifications of the Product shall not be covered under this Warranty;

g. regular maintenance as required by any manual, instructions, and guidelines prepared and distributed by DreamCast and generally accepted industry standards and practices shall not be covered under this Warranty;

h. service calls initiated by the Buyer requesting the assistance of DreamCast to correct the installation of the Product or provide guidance as to the usage of the Product shall not be covered under this Warranty;

i. damage caused by servicing the Product (including, without limitation, any upgrades, improvements, dismantling, or expansions) by any person or entity who is not a representative, agent, or technician of DreamCast shall not be covered under this Warranty;

j. modifications to Product which alter functionality or capability carried out without the express written permission of DreamCast shall not be covered under this Warranty;

k. any defects caused by regular wear and tear, or any regular aging of the Product, shall not be covered under this Warranty;

l. any damage to any areas, materials, or property of the Buyer surrounding the Product or upon which the Product is situated shall not be covered under this Warranty;

m. except as expressly set out herein or otherwise agreed by DreamCast in writing, any costs and expenses associated with pick-up and delivery of the Products, and any incidental shipping or holding costs and expenses associated with delivery of the Product or any parts thereof to an authorized customer service centre of DreamCast shall not be covered under this Warranty; and

n. under no circumstances whatsoever shall any coverage under this Warranty exceed the amount of the price paid or payable by the Buyer to DreamCast for the Product.

3. Except as expressly provided for herein, DreamCast shall not be responsible for any direct or indirect, special, incidental, or consequential damages resulting from any breach of Warranty condition, including, without limitation, loss of use, revenue, actual or anticipated profits (including loss of profits relating to a contract), use of money, anticipated savings, business, opportunity, goodwill, reputation, or any damage to, compromise, or corruption of data, any indirect or consequential loss or damage howsoever caused, including without limitation, the replacement of equipment and property. The foregoing limitation shall not apply to any statutory liability for intentional and grossly negligent acts and omissions.

4. All obligations of DreamCast under this Warranty shall immediately and completely terminate upon expiry of the Warranty Period.

Procedures

1. In the event of a defect in the Product covered under this Warranty occurring during the Warranty Period, the Buyer shall contact DreamCast to report the alleged defect during the business hours of 9:00 to 17:00 (Pacific Standard Time) from Monday to Friday (collectively, the “Business Hours”), and a representative of DreamCast shall respond to the report during Business Hours.

DREAMCAST DESIGN AND PRODUCTION LTD. ("DreamCast") LIMITED WARRANTY

CONCRETE FIRE PITS CONT.

The DreamCast representative shall conduct an inquiry to determine whether the Product is covered under this Warranty, and if Warranty coverage is deemed appropriate by DreamCast, in its sole discretion, DreamCast shall instruct the Buyer to return the Product, at the Buyer's sole cost and expense, to DreamCast; or, if, as a result of the method of installation of the Product, the Product cannot be returned to DreamCast, DreamCast may, in its sole discretion elect to collect the Product from the Buyer. In the event that DreamCast elects not to collect the Product from the Buyer, the Buyer shall be solely responsible for the removal of the Product.

2. Upon delivery of a reported defective Product deemed covered under this Warranty, the Buyer shall produce for DreamCast the Product warranty certificate, along with proof of date of purchase.

3. Upon receipt by DreamCast of a reported defective Product deemed covered under this Warranty, DreamCast shall, at its sole option and discretion, and at its own cost, either:

a. repair the Product using new or previously used parts, elements, or components that are equivalent to new in performance and reliability; or

b. replace the Product, or any defective part, element, or component thereof, with the same model (or later model if the same model is no longer available).

4. When a Product or any part, element, or component thereof is replaced in accordance with this Warranty, the replacement part, element, or component shall, at the time of replacement, become the property of the Buyer, and the replaced part, element, or component shall, at the time of replacement, become the property of DreamCast.

5. Upon completion of the repair or replacement of the Product, as the case may be, the Buyer shall bear the cost, expense, responsibility, liability, and risk of return delivery of the Product to the Buyer.

WARMING TRENDS® LIMITED WARRANTY

FIREPIT BURNER

ALL CROSSFIRE BRASS BURNERS HAVE A LIMITED LIFETIME WARRANTY.

ALL BURNERS MUST BE COVERED WHEN NOT IN USE OR WARRANTY IS NULL AND VOID

Warming Trends® warrants its products to be free from defective material and workmanship under normal service and use. This warranty covers manufacturing defects only and does not cover defects due to normal wear and tear; it does not warrant any product or part that has been altered,

damaged, damaged in shipping, disassembled, modified, misused, not properly maintained, not installed, or not kept in regular use after installation. Warming Trends® liability shall be restricted to the purchase price of the product only and makes no other warranty, express or implied, but not limited to, the implied warranties of salability and appropriateness for a specified purpose, with respect to its products and parts, whether used along or in combination with others. Warming Trends® is free of liability for any damages caused by the unit, as well as in-convenience expenses, material or labor charges incurred by any service call, repair, removal or reinstallation of any unit. Incidental or consequential damages are not covered by this warranty.

Warranty does not cover damage to systems due to debris in the gas lines or damage to system due to water.

Owner is responsible for reading and understanding warranty for full terms and conditions Warming Trends®, at its discretion, agrees to repair or replace defective product if returned to Warming Trends® within the warranty period. The respective warranty time periods are effective from the original date of purchase.

The warranty is non-transferable and applies only to the original purchaser. In addition, this warranty is automatically void if the unit's serial number has been removed or altered in any way.

Problems in the functioning of the systems due to gas plumbing or electrical installed by others are not covered by any warranty offered by Warming Trends®.

No dealer, distributor, or other person has the authority to represent or warrant a Warming Trends® product beyond the terms contained within this warranty, and Warming Trends® assumes no liability for such warranty representations.

Any questions concerning this warranty should be directed to the Warming Trends® corporate office.

Return Policy of Warranty Product

Any Warming Trends® product deemed by Warming Trends® as defective and covered by the warranty may be returned to Warming Trends® for assessment to determine if repair or replacement is necessary. In order to return a product, you must have a Return Merchandise Authorization number (RMA#).

Please contact Warming Trends® at orders@Warming-Trends.com or 877-556-5255 to obtain an RMA#. All returned merchandise must have the RMA# clearly printed on the outside of the package. Return shipping costs are the purchaser's responsibility. Warming Trends® is not responsible for product damaged or lost in transit. It is recommended that return items are shipped via a delivery service that can be tracked and/or insured to confirm receipt.

Replacement Parts List

Please contact DreamCast for any replacement parts.

| | |
|-----------------|---|
| CV250-LP/NG | 250k BTU Control Valve - LP/NG |
| CNTRL-PLATE | Mounting Plate Kit for Control Valve |
| CONTROLKNOB | Firepit Control Knob |
| PILOTASSY-LP/NG | Manual Pilot Assembly - LP / NG |
| PILOT-BRACKET | Pilot Assembly Mounting Bracket Kit |
| FLEX-1/2x36/48 | 1/2" Whistle Free Flex Line - 36" / 48" |
| FLEX-3/4x36/48 | 3/4" Whistle Free Flex Line - 36" / 48" |
| PIPECLAMP | Split Ring Pipe Clamp |
| 1/2-ELBOW | 1/2" Street Elbow Gas Fitting |
| 1/2-NIPPLE | 1/2" x 1 1/2" Nipple Gas Fitting |
| APS-ZEN36 | Zen 36 Support Stand |
| AP-ZEN34 | Zen 34 Aluminum Plate |
| AP-ZEN36 | Zen 36 Aluminum Plate |
| AP-ZEN48 | Zen 48 Aluminum Plate |
| AP-30-ROUND | 30" Round Aluminum Plate |
| AP-20-ROUND | 20" Round Aluminum Plate |
| AP-CUBO | Cubo Aluminum Plate |
| AP-LINEAR-38 | Linea 48 Aluminum Plate |
| AP-LINEAR-50 | Linea 60 Aluminum Plate |
| AP-LINEAR-62 | Linea 72 Aluminum Plate |
| AP-LINEAR-32 | Quadra 48 Aluminum Plate |
| AP-LINEAR-44 | Quad. 60 / Phan. 48 Aluminum Plate |
| AP-LINEAR-56 | Quad. 72 / Phan. 60 Aluminum Plate |
| AP-LINEAR-68 | Quad. 84 / Phan. 72 Aluminum Plate |
| ASSY-BOLTS | Pack of Assembly Bolts |

| | |
|-----------------------|--|
| CFB-60-LP/NG | Crossfire Original Burner 60k LP / NG |
| CFB-120-LP/NG | Crossfire Original Burner 120k LP / NG |
| CFB-180-LP/NG | Crossfire Original Burner 180k LP / NG |
| CFBL-110-LP/NG | Crossfire Linear Burner 110k LP / NG |
| CFBL-150-LP/NG | Crossfire Linear Burner 150k LP / NG |
| CFBL-190-LP/NG | Crossfire Linear Burner 190k LP / NG |
| CFBL-210-LP/NG | Crossfire Linear Burner 210k LP / NG |
| CFBL-250-LP/NG | Crossfire Linear Burner 250k LP / NG |
| DC-LOTUS32 | Lotus 32 Concrete Bowl |
| DC-34"BOWL | Zen 34 / Aura 36 Concrete Bowl |
| DC-36"BOWL | Zen 36 / Lotus 45 Concrete Bowl |
| DC-48"BOWL | Zen 48 / Aura 48 Concrete Bowl |
| DC-LOTUSTOP | Lotus 45 Concrete Top |
| DC-BLOQ | Bloq Concrete Firepit |
| DC-CUBO | Cubo Concrete Firepit |
| DC-Q-BASE-48/60/72/84 | Quadra 48/60/72/84 Concrete Base |
| DC-L-BASE-48/60/72 | Libra 48/60/72 Concrete Base |
| DC-E-BASE-36/48 | Element 36/48 Concrete Base |
| DC-Q-TOP-48/60/72/84 | Quadra 48/60/72/84 Concrete Top |
| DC-L-TOP-48/60/72 | Libra 48/60/72 Concrete Top |
| DC-E-TOP-36/48 | Element 36/48 Concrete Top |
| DC-LINEA-48/60/72 | Linea 48/60/72 Concrete Firepit |
| DC-PHANTOM-48/60/72 | Phantom 48/60/72 Concrete Firepit |
| DC-AURATOP-36/48 | Aura 36 / 48 Concrete Top |
| LAVA-ROCK | 20kg Bag of Lava Rock |

DreamCast

design and production

2-PIECE FIRE TABLE W/ RECTANGULAR BURNER PLATE

EXAMPLE ASSEMBLY DIAGRAM
FOR:

- ALL QUADRA MODELS

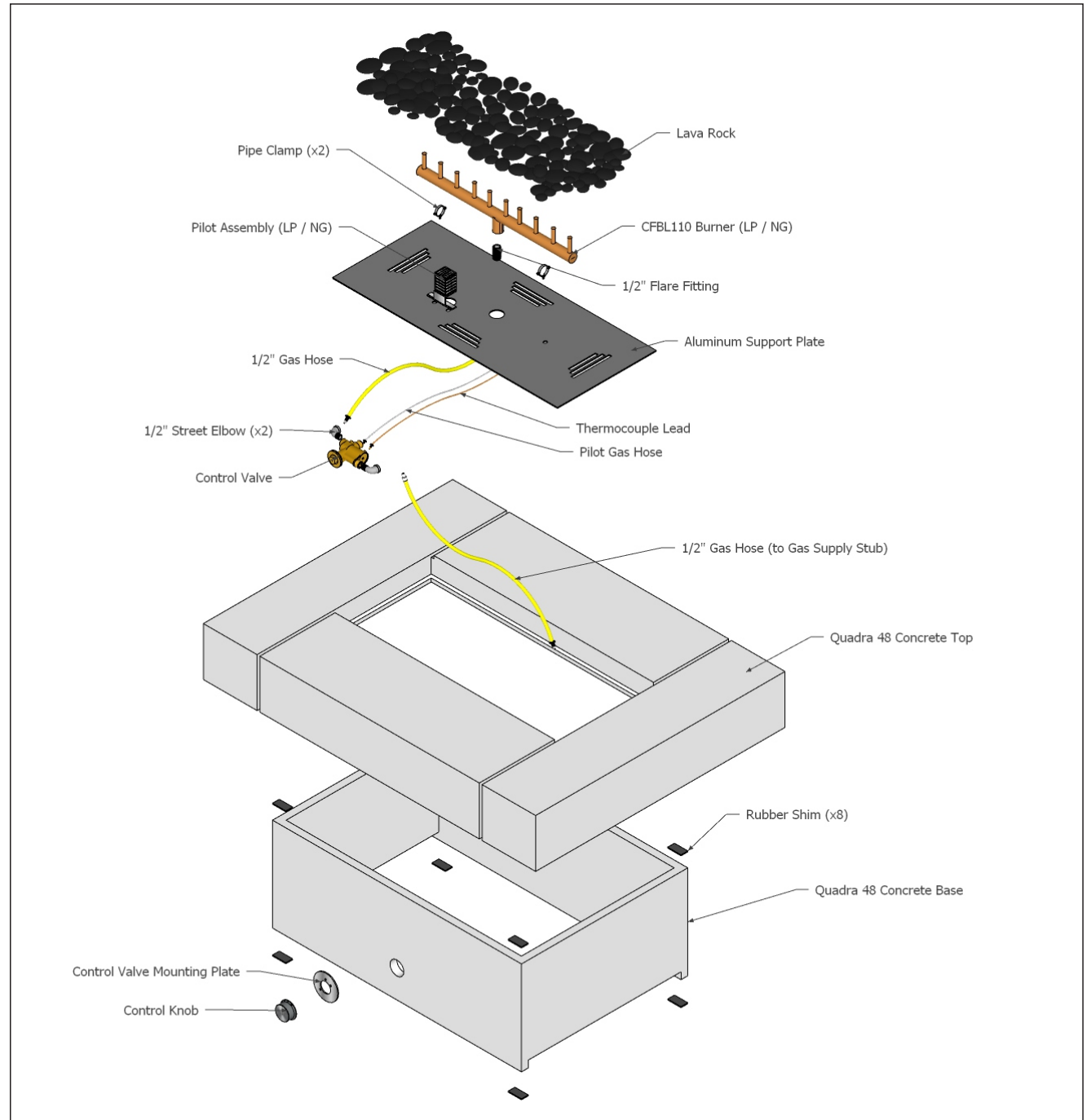

DreamCast

design and production

2-PIECE FIRE TABLE WITH ROUND BURNER PLATE

EXAMPLE ASSEMBLY DIAGRAM
FOR:

- ALL ELEMENT MODELS
- ALL LIBRA MODELS

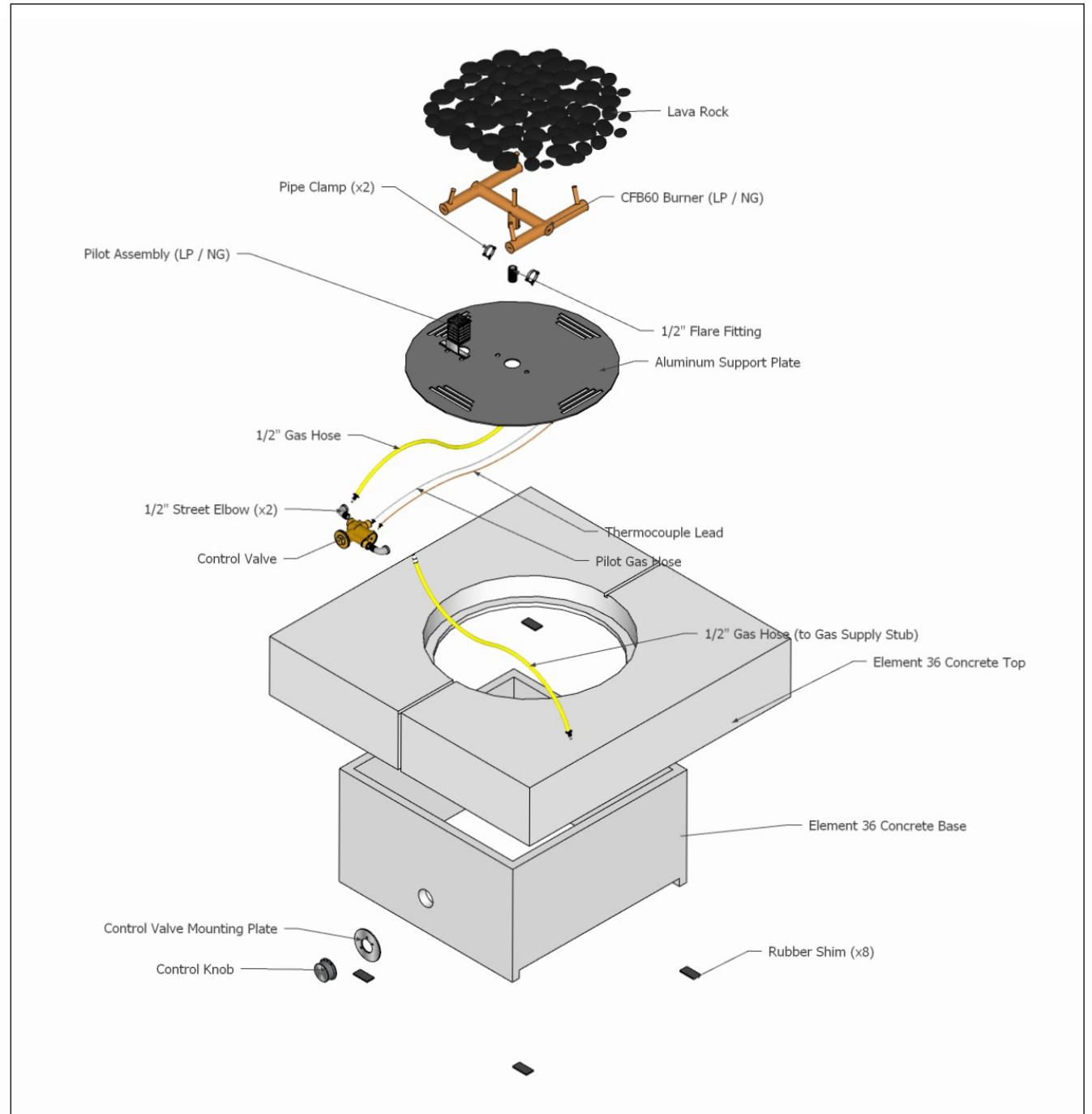

DreamCast

design and production

1-PIECE FIRE TABLE WITH ROUND BURNER PLATE

EXAMPLE ASSEMBLY DIAGRAM
FOR:

- BLOQ

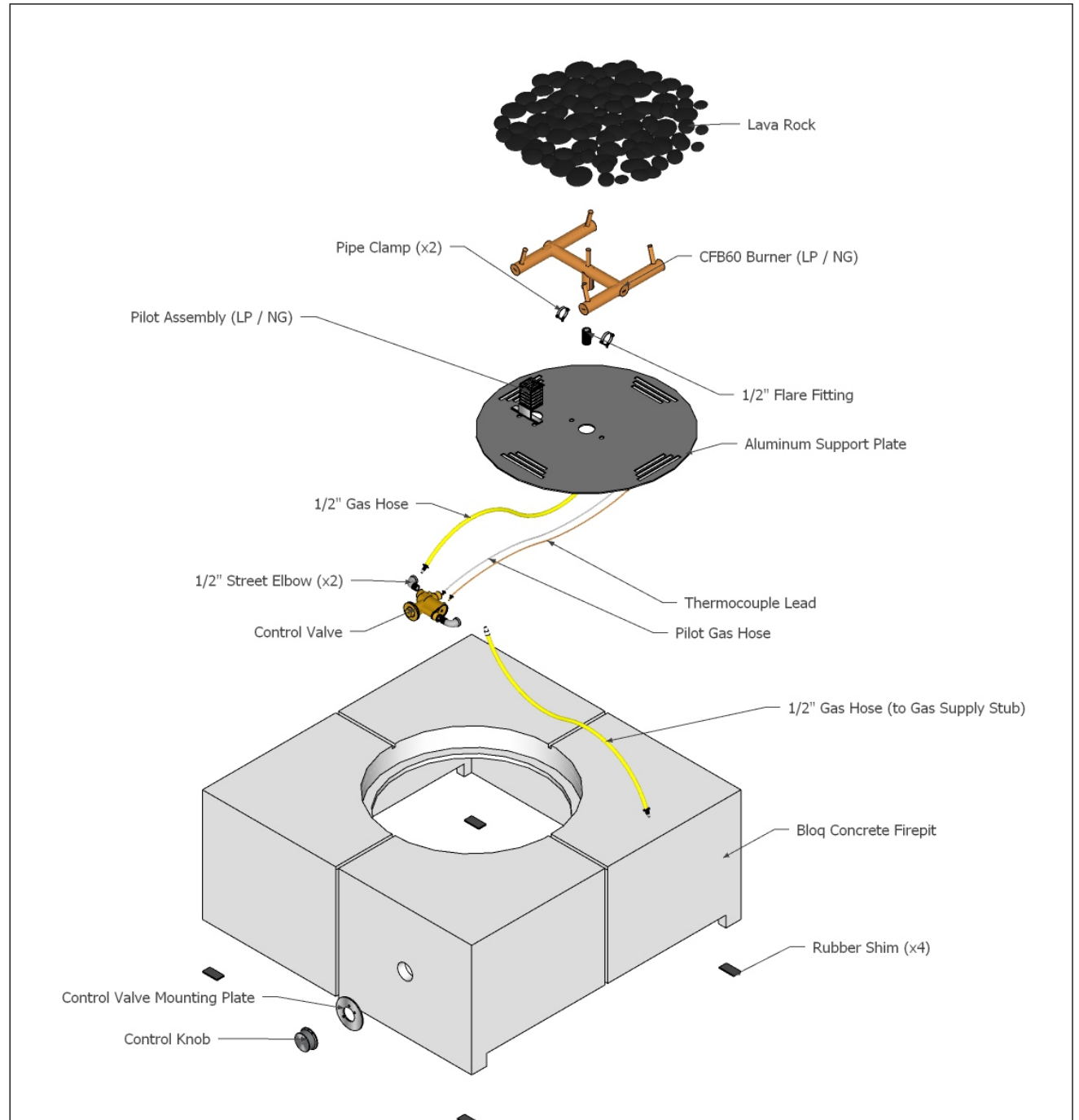

DreamCast

design and production

1-PIECE FIRE TABLE WITH RECTANGULAR BURNER PLATE

EXAMPLE ASSEMBLY DIAGRAM
FOR:

- CUBO
- ALL LINEA MODELS
- ALL PHANTOM MODELS

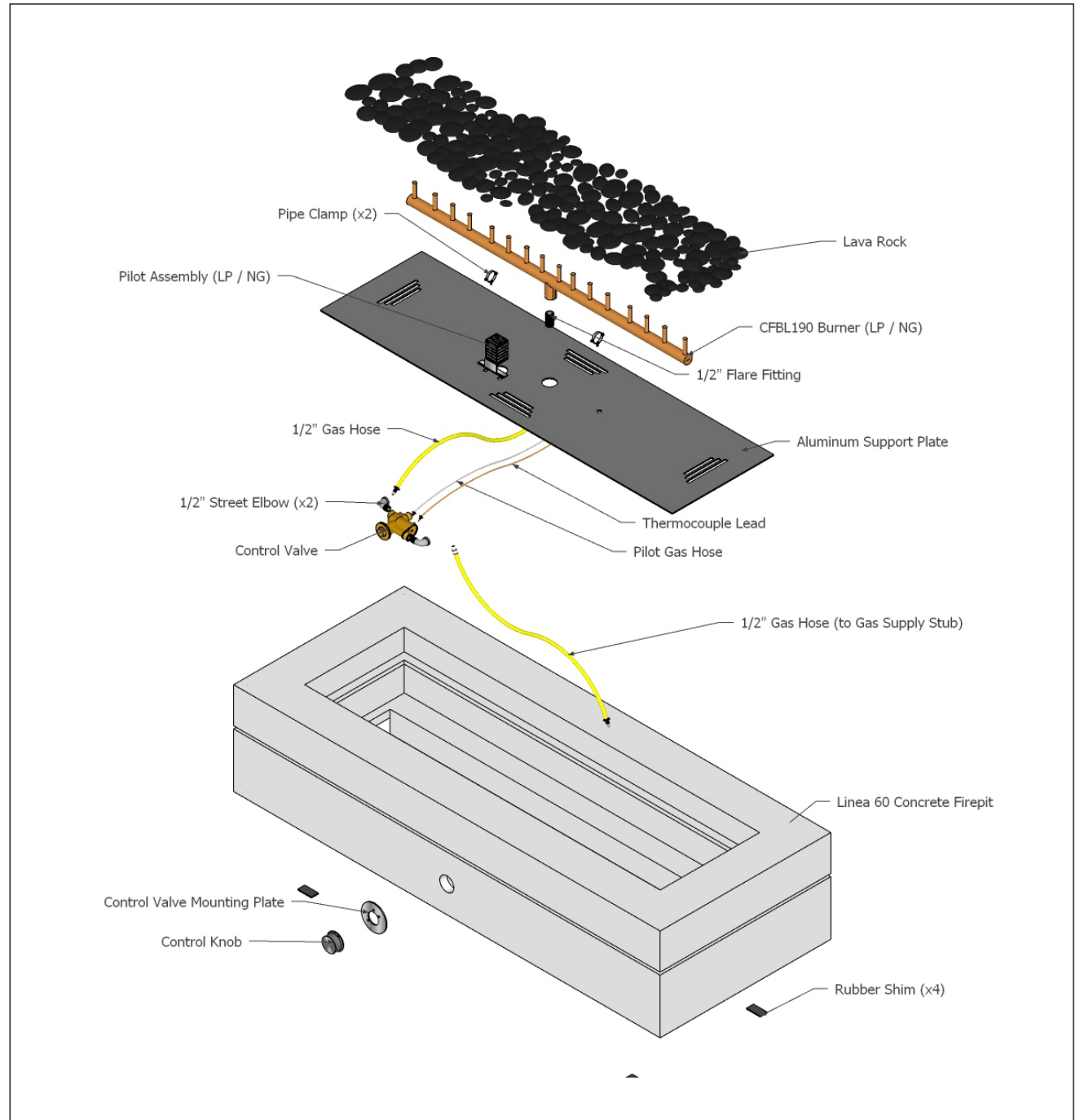

DreamCast

design and production

2-PIECE FIRE BOWL WITH ROUND BURNER PLATE

EXAMPLE ASSEMBLY DIAGRAM
FOR:

- ALL AURA MODELS
- LOTUS 45

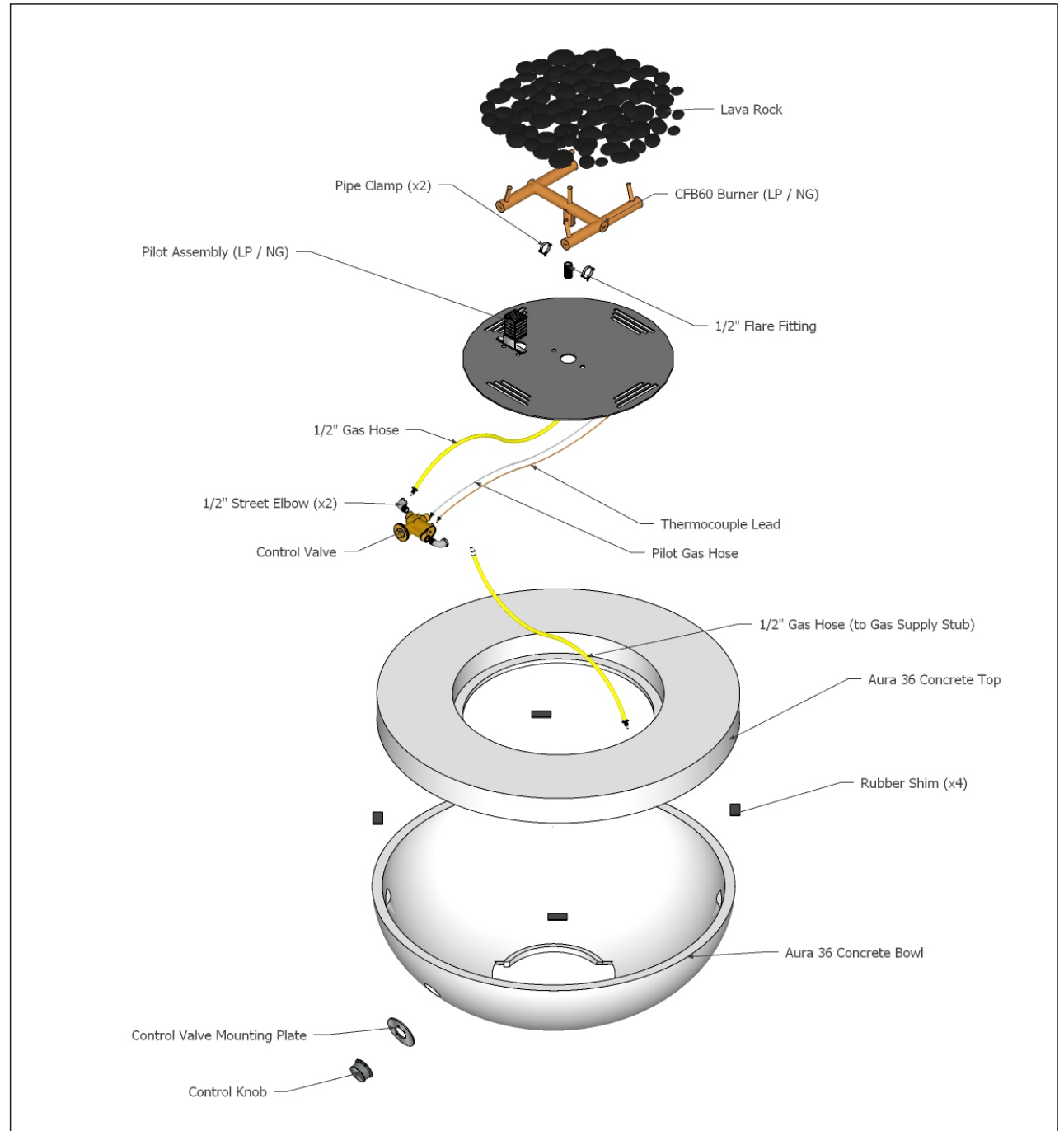

DreamCast

design and production

1-PIECE FIRE BOWL WITH ROUND BURNER PLATE

EXAMPLE ASSEMBLY DIAGRAM
FOR:

- ZEN 34, 48
- LOTUS 32

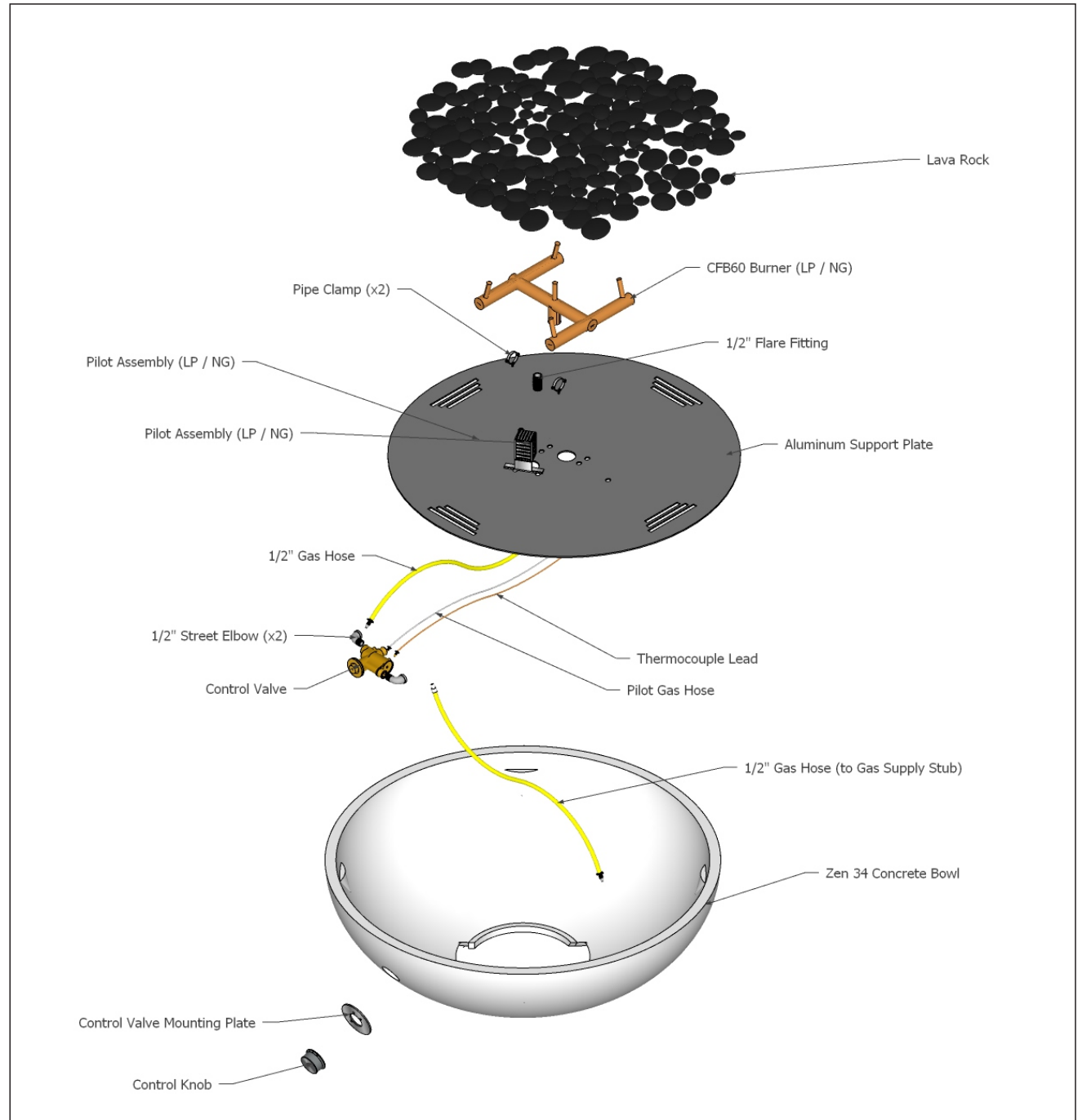

DreamCast

design and production

1-PIECE FIRE BOWL WITH ROUND BURNER PLATE & STAND

EXAMPLE ASSEMBLY DIAGRAM
FOR:

- ZEN 36

