

ALTITUDE™ 42 DIRECT VENT GAS FIREPLACE



Specifications

Model	BTU	Width		Height		Depth		Glass Size
		Actual	Framing	Actual	Framing	Actual	Framing	
A36NTE A36PTE	30,000	41 13/16	43 1/4	45 7/16	47 5/8	18 7/8	19	25 115/16 x 34 3/4

Dimensions

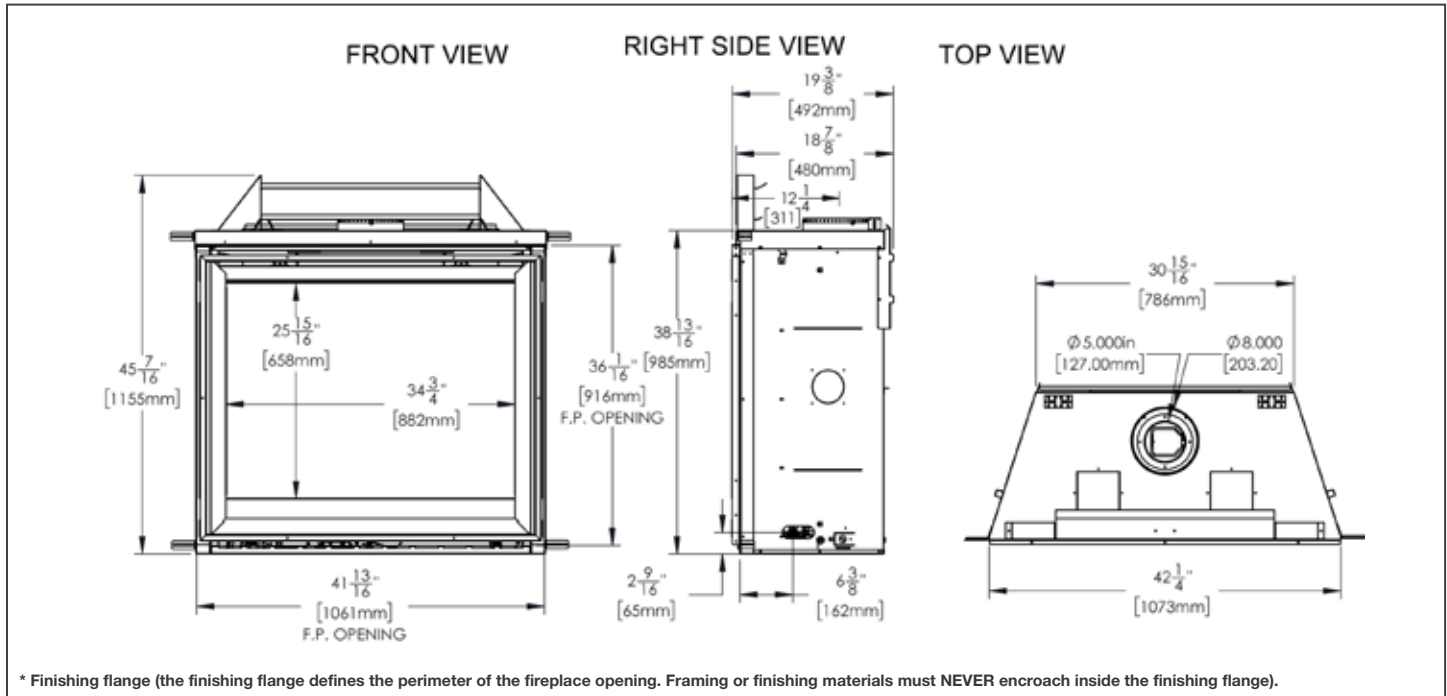

Appliance Location

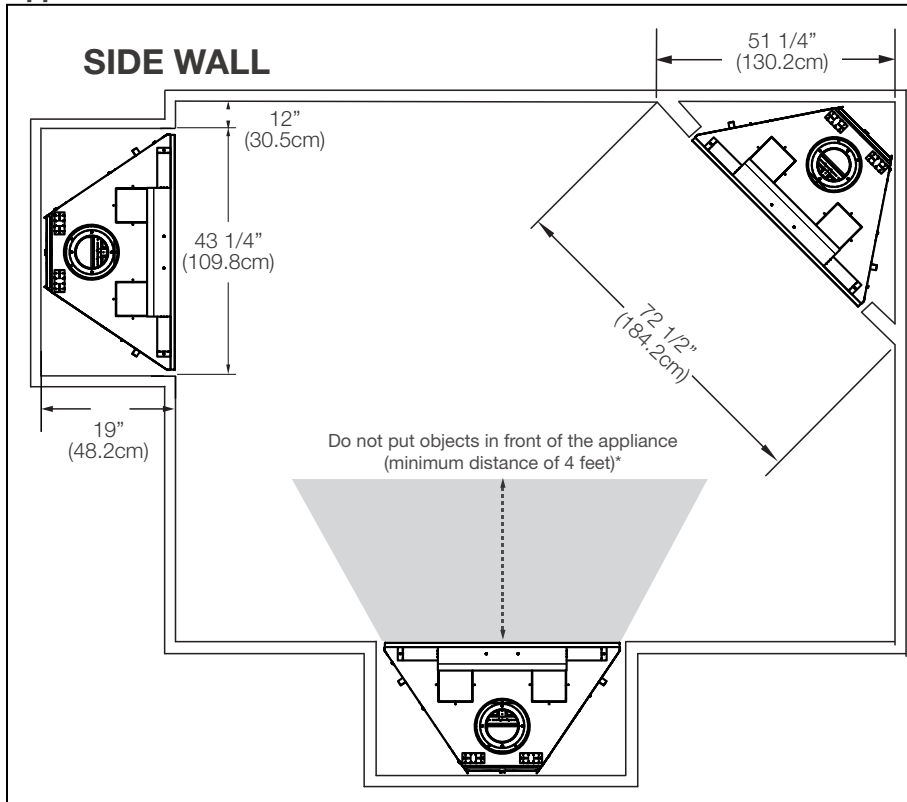

Combustible Mantel Clearances

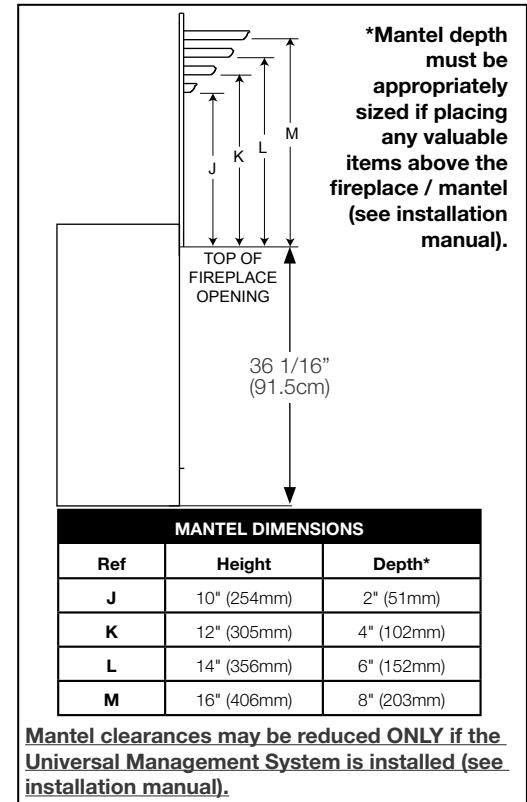

W415-4134 / 01.13.23

ALTITUDE™ 42 DIRECT VENT GAS FIREPLACE



Product information provided is not complete and is subject to change without notice. Please consult the installation manual for the most up to date installation information.

Wall Penetration

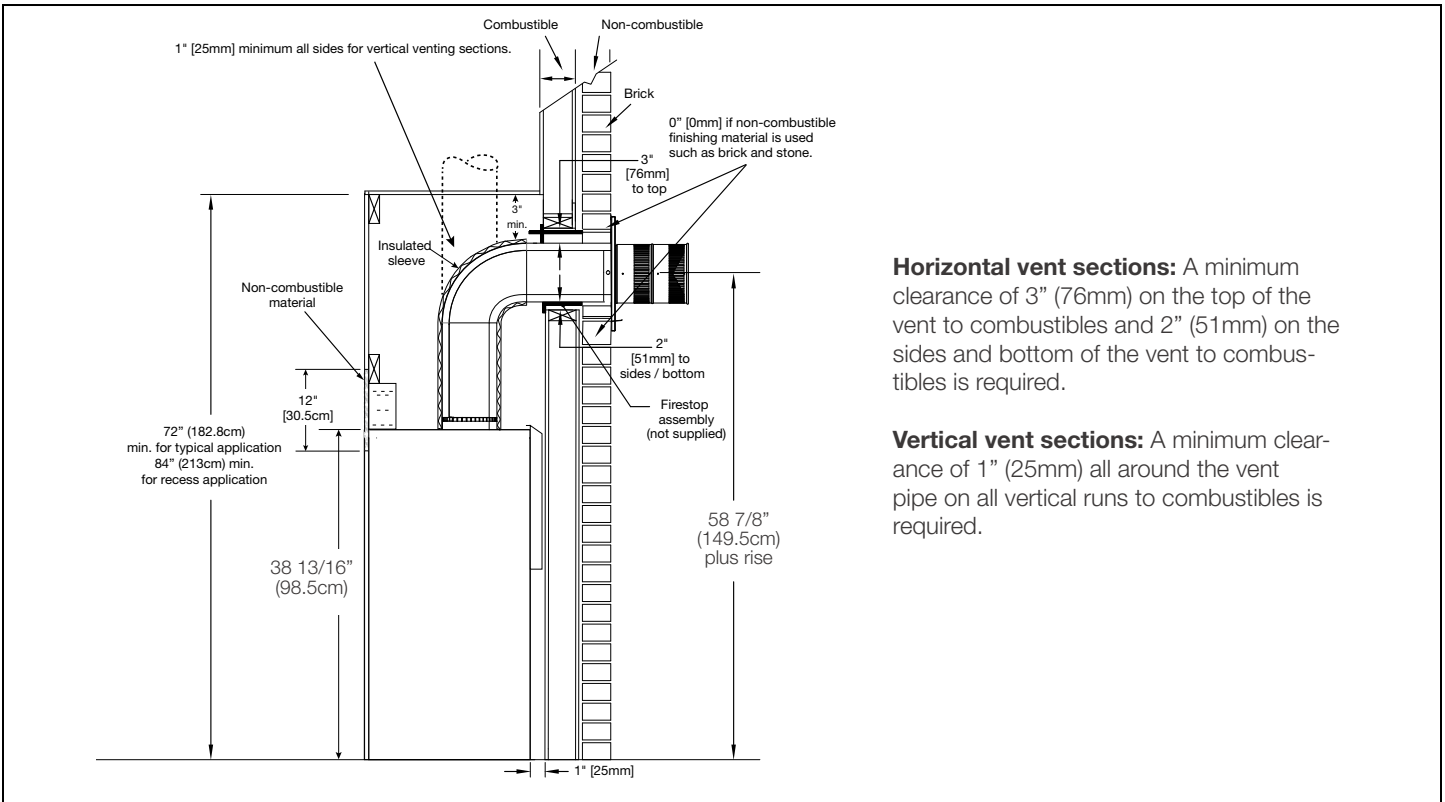

Flush & Recessed Framing

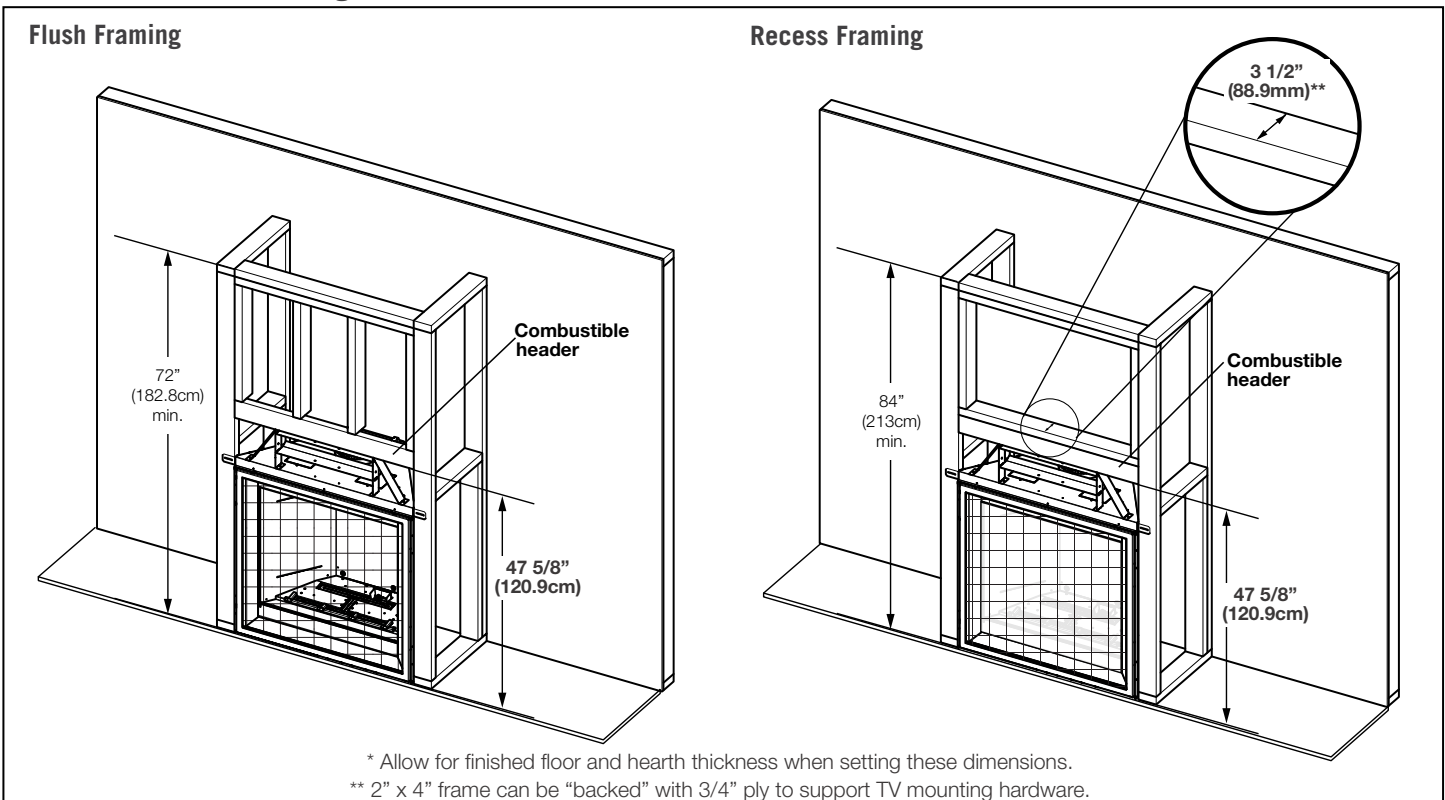

W415-4134 / 01.13.23

Spécifications

Modèle	BTU	Largeur		Hauteur		Profondeur		Dimensions de Vision
		Actual	Framing	Actual	Framing	Actual	Framing	
A36NTE	30 000	41 13/16	43 1/4	45 7/16	47 5/8	18 7/8	19	25 115/16 x 34 3/4
A36PTE								

Dimensions

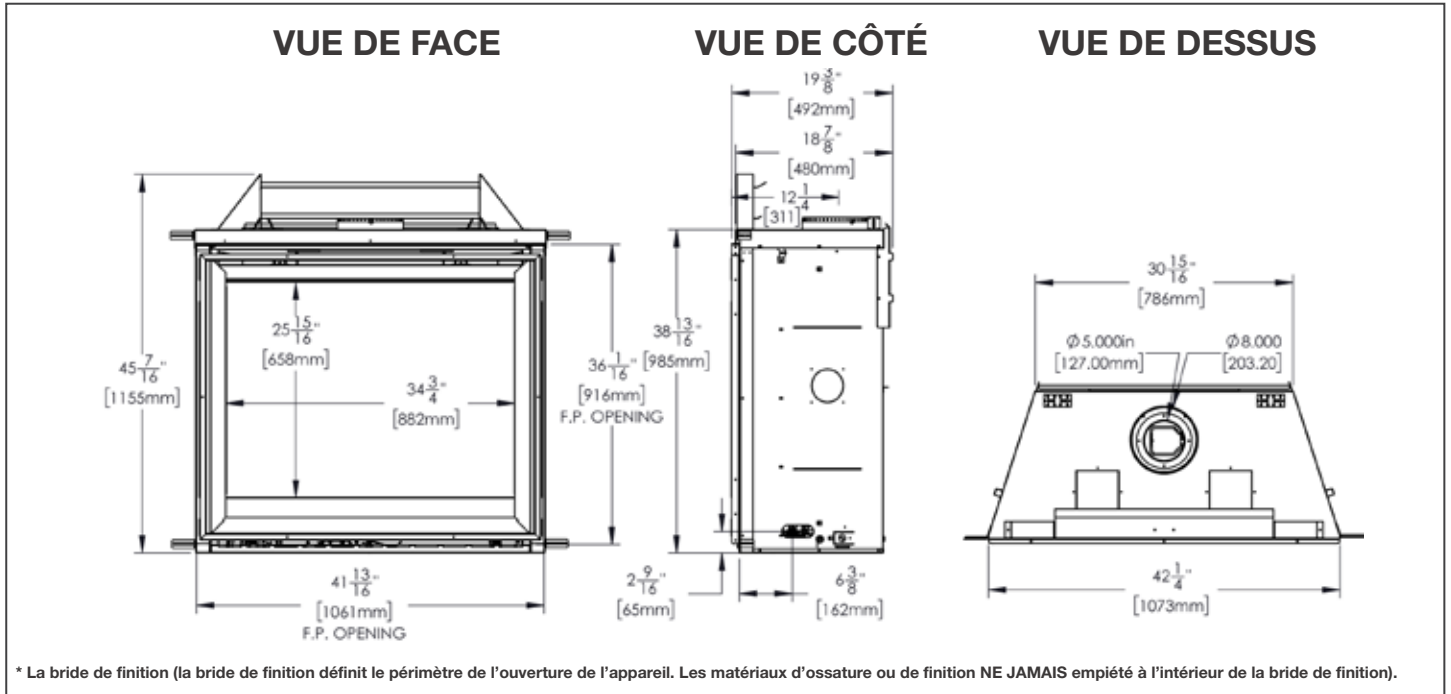

Emplacement de l'Appareil

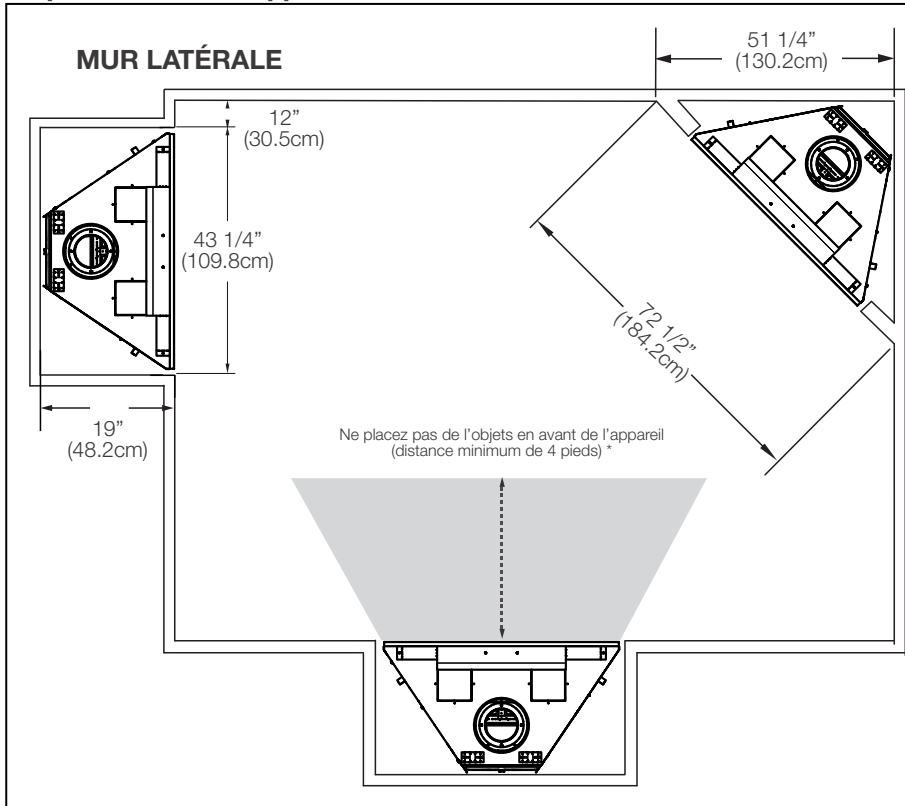

Dégagements Combustible de la Tablette

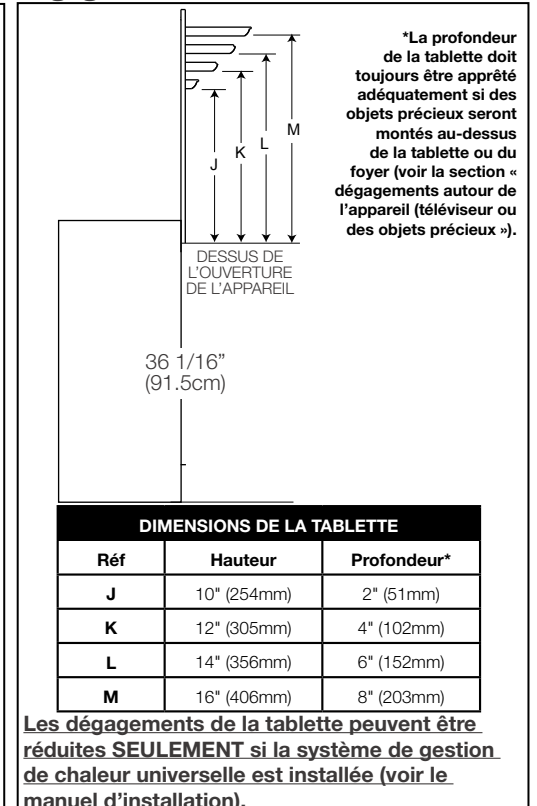

L'information du produit fourni n'est pas complet et est sujet de changer sans préavis. Consultez le manuel d'installation pour information d'installation actuel.

Pénétration du Mur

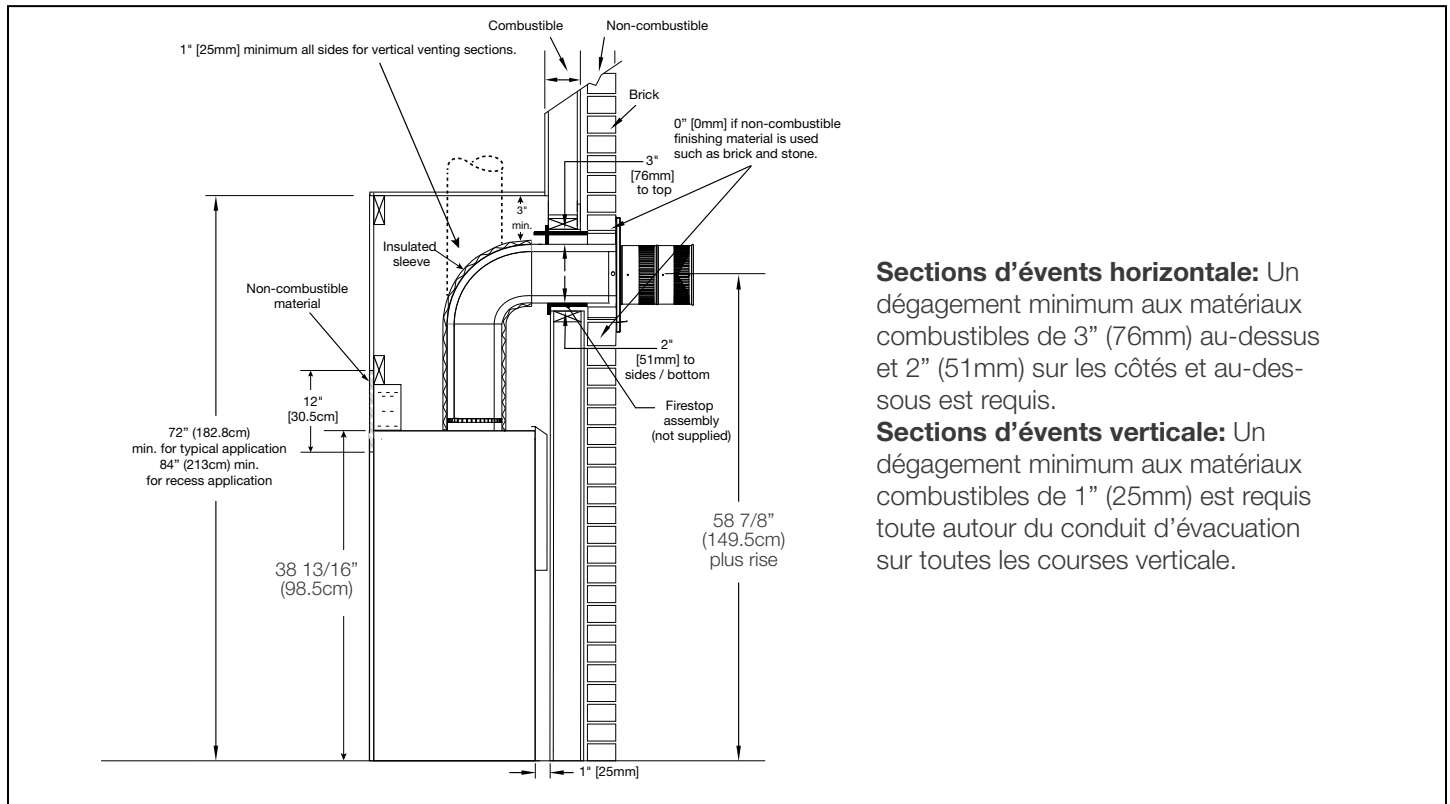

Sections d'évents horizontale: Un dégagement minimum aux matériaux combustibles de 3" (76mm) au-dessus et 2" (51mm) sur les côtés et au-dessous est requis.

Sections d'évents verticale: Un dégagement minimum aux matériaux combustibles de 1" (25mm) est requis toute autour du conduit d'évacuation sur toutes les courses verticale.

Encadrement Affleuré et Encastré

