

Specifications

Model	BTU	Width		Height		Depth		Viewing Area
		Actual	Framing	Actual	Framing	Actual	Framing	
NEFB26H	5,000	26	25 1/4	20 5/16	19 7/8 + F	7 3/4	7 3/4	23 15/16 X 15 3/16
NEFB30H		30	29 1/4					27 15/16 X 15 3/16

Dimensions

FRONT VIEW

SIDE VIEW

TOP VIEW

Ref.	NEFB26H	NEFB30H
A	23 15/16" (607mm)	27 15/16" (709mm)
B	26" (660mm)	30" (762mm)
C	24 3/4" (629mm)	28 13/16" (732mm)

Rough Framing

Rough Framing

Rough Framing in a Corner

Ref.	NEFB26H	NEFB30H
A	7 3/4" (197mm)	
B	25 1/4" (641mm)	29 1/4" (743mm)
C	19 7/8" (505mm) + F	
D	39 3/4" (1010mm)	43 3/4" (1111mm)
E	28" (710mm)	30 13/16" (783mm)
F	Will vary with floor / mantel base thickness	

Product information provided is not complete and is subject to change without notice. Please consult the installation manual for the most up to date installation information.

W415-2946 / A / 03.10.21

Unpacking & Testing Appliance

Carefully remove the appliance from the box. Prior to installing the appliance, remove all packaging material and test to make sure the appliance operates properly by plugging the power supply cord into a conveniently located 120V, 15 Amp minimum grounded outlet.

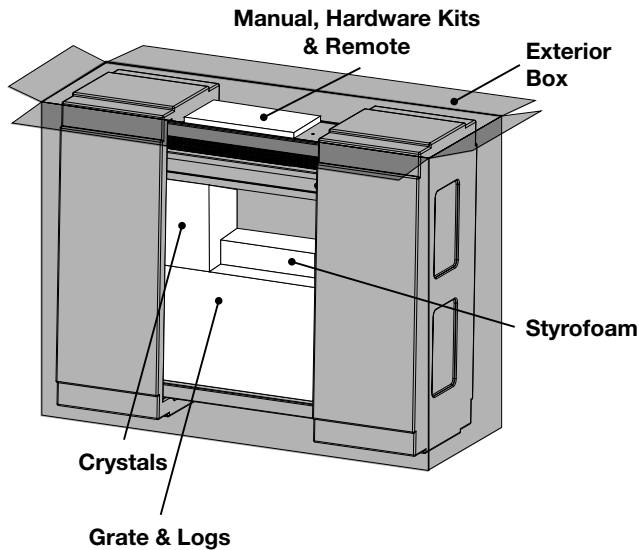

Minimum Mantel Clearances

⚠ WARNING

- When using paint or lacquer to finish the mantel, the paint or lacquer must be heat resistant to prevent discoloration.

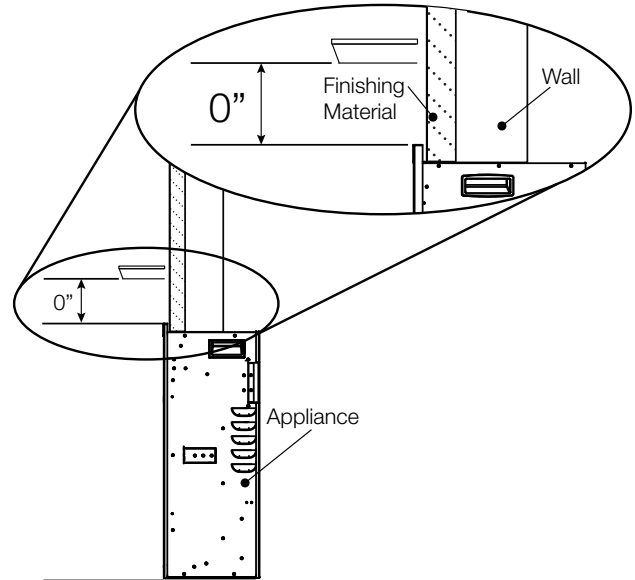

Optional Trim Kits (NEFTK2636 & NEFTK3040)

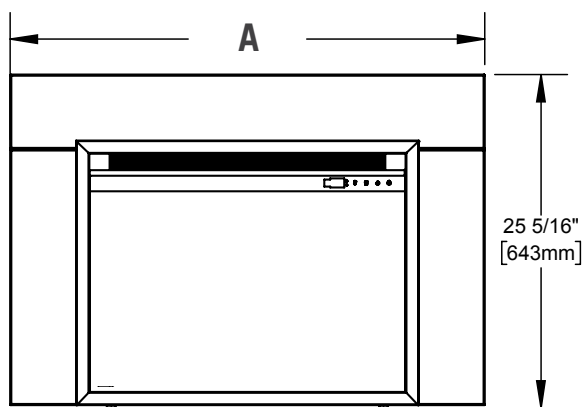

3 pieces of trim installed

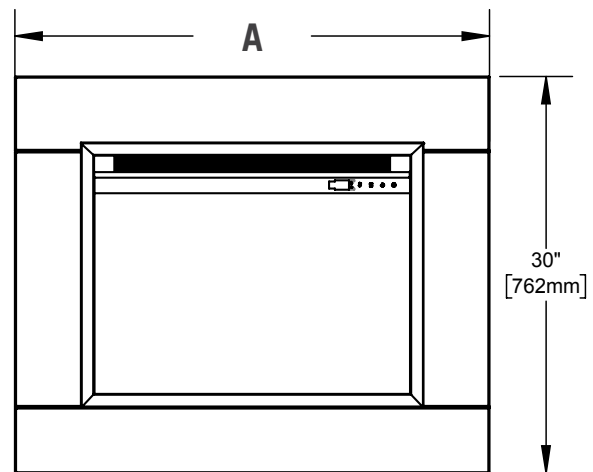

4 pieces of trim installed

Ref.	NEFTK2636 (fits NEFB26H)	NEFTK3040 (fits NEFB30H)
A	36" (914mm)	40" (1016mm)

Spécifications

Modèle	BTU	Largeur		Hauteur		Profondeur		Dimensions de Vision
		Réel	Ossature	Réel	Ossature	Réel	Ossature	
NEFB26H	5,000	26	25 1/4	20 5/16	19 7/8 + F	7 3/4	7 3/4	23 15/16 X 15 3/16
NEFB30H		30	29 1/4					27 15/16 X 15 3/16

Dimensions

VUE DE FACE

VUE DE CÔTÉ

VUE DE DESSUS

Réf.	NEFB26H	NEFB30H
A	23 15/16\" (607mm)	27 15/16\" (709mm)
B	26\" (660mm)	30\" (762mm)
C	24 3/4\" (629mm)	28 13/16\" (732mm)

Ossature Approximatif

Ossature Approximatif

Ossature Approximatif dans un Coin

Réf.	NEFB26H	NEFB30H
A	7 3/4" (197mm)	
B	25 1/4" (641mm)	29 1/4" (743mm)
C	19 7/8" (505mm) + F	
D	39 3/4" (1010mm)	43 3/4" (1111mm)
E	28" (710mm)	30 13/16" (783mm)
F	Will vary with floor / mantel base thickness	

Information du produit fourni n'est pas complet et est sujet de changer sans préavis. Consultez le manuel d'installation pour information d'installation actuel.

W415-2946 / A / 03.10.21

Déballage & Vérification d'Appareil

Retirez soigneusement l'appareil de la boîte et retirez les supports. Avant d'installer l'appareil, retirez tous les matériaux d'emballage et vérifiez que l'appareil fonctionne correctement en branchant le cordon d'alimentation dans une prise de terre minimale de 120V, 15 ampères, mise à la terre.

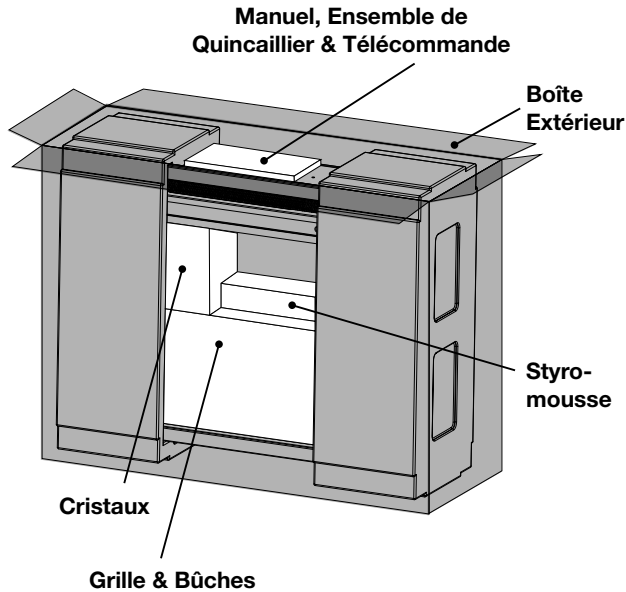

Dégagements Minimaux à la Tablette

⚠ AVERTISSEMENT

- Lorsque vous utilisez de la peinture ou de la laque pour finir la tablette, la peinture ou la laque doit être résistante à la chaleur pour éviter la décoloration.

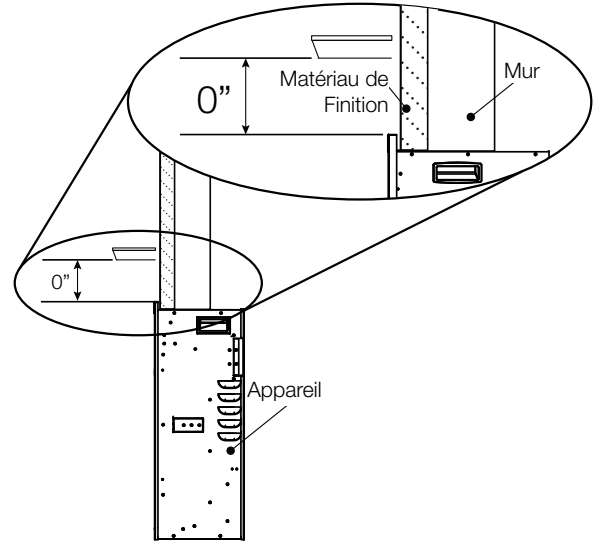

Kits de Finition en Option (NEFTK2636 & NEFTK3040)

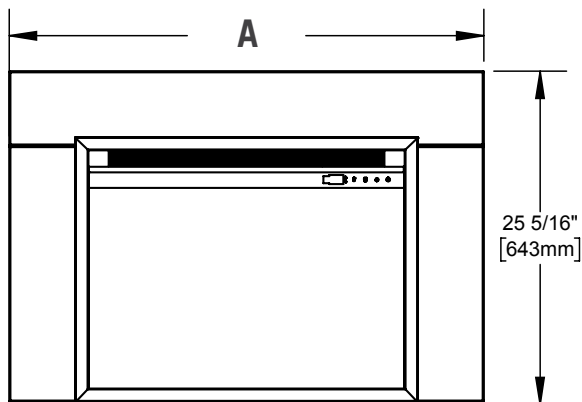

3 pièces de garniture installées

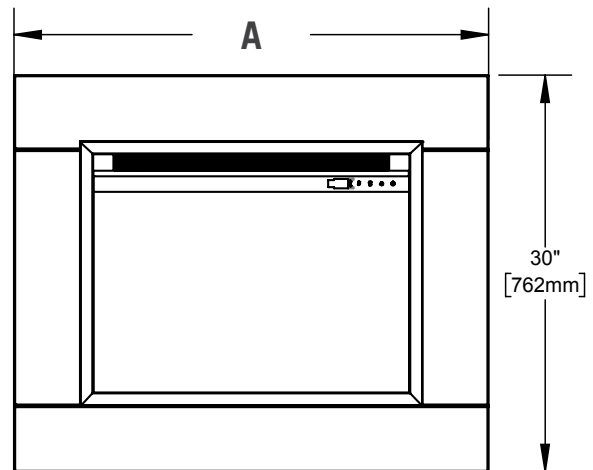

4 pièces de garniture installées

Réf.	NEFTK2636 (pour NEFB26H)	NEFTK3040 (pour NEFB30H)
A	36" (914mm)	40" (1016mm)