

A woman is relaxing on a wooden lounge chair on a deck. She is holding a smartphone and looking at it. The deck is made of light-colored wood. To her left is a large window with a dark frame. Above the window, a long, rectangular heater with a decorative orange and white pattern is mounted. The background shows a lush green landscape with trees and a bright sun setting or rising, creating a warm, golden glow. The overall scene is peaceful and inviting.

EUROfase
HEATING

Step Outside with Eurofase



**“Our diverse team brings together creativity,
strategic thinking, and cutting-edge
heating technologies to craft solutions
for a warmer tomorrow.”**

- Zack Sharon, Vice President

Welcome to Eurofase Heating - the newest member of the Eurofase family!

For the past 30 plus years, contractors, architects, and designers have relied on Eurofase as their go-to brand for providing a diverse selection of high-quality, innovative products for both residential and commercial applications.

As a natural extension to Eurofase, Eurofase Heating is the perfect addition to complete every outdoor space. We invite you to learn more about Eurofase Heating products in this catalog, or by visiting us online.

Table of Contents

About Us	pg. 4
Why Infrared	pg. 5
■ Heaters	
EF15	pg. 7
EF20	pg. 8
EF25	pg. 9
EF30	pg. 10
EF40	pg. 11
EF50	pg. 12
EF60	pg. 13
LP30	pg. 14
LP40	pg. 15
■ Décor Plates	pg. 17
■ Mounting	
Flush Mount	pg. 22
Suspension Kit	pg. 22
Pole Mount	pg. 23
■ Controls	
On/Off Switches	pg. 25
Smart Wifi Control	pg. 26
Contactor Box	pg. 27
Universal Relay Box	pg. 28
Timers and Dimmers	pg. 29
Create Your Space	pg. 30
Warranty	pg. 32



Where comfort & design meet outdoor living

At Eurofase Heating, we pride ourselves on developing products that meet the highest quality and safety standards while at the same time keeping our eyes on the latest architectural trends to ensure that our products bring added function and form to your space.

Imagine investing in patio furniture, a BBQ grill, or any other expensive outdoor furnishings but not being able to enjoy your space all year round because of weather constraints. Forced air heating systems can be ineffective in outdoor spaces, which may lead you to use structures such as fire pits. Although beautiful, its inability to heat large spaces or have ease of control may create more strife than pleasure.

At Eurofase Heating, we choose **infrared**

Infrared heaters emit a clean and safe beam of light that primarily heats objects rather than the surrounding air. This results in an immediate feeling of warmth. Infrared heat is evenly distributed and unaffected by factors like drafts or wind, providing consistent comfort.



Instant Heat



No Greenhouse Gases



Silent Operation



Behind the Name:

Light rays that are below red in the spectrum are not visible to the human eye but have the highest temperature of all the colors. That light is known as "Infra (below) Red".



Indoor/Outdoor



No Ventilation Required



Low Maintenance

Eurofase Heating has an ideal approach to keep you warm. Infrared heaters instantly distribute heat evenly without having to worry about ventilation requirements or wind conditions. These silent heaters enable you to enjoy quality time with friends and family indoor or outdoor. Eurofase Heating helps create a safe and sustainable space for yourself and your loved ones!





EF15

39" 1500 WATT ELECTRIC SINGLE QUARTZ ELEMENT HEATER



FEATURES

The perfect blend of functionality and aesthetics can elevate any outdoor area. Offering a lifestyle experience, these heaters are remarkably precise and versatile. The Eurofase 1500 Watt 120V heater warms an approximate 5 x 6 foot area and is advised to be installed no higher than 8 feet off the ground. Eurofase provides the EF15 series in a standard Black, Stainless Steel or White finish and offers the option to upgrade a custom finish to complement any patio decor.

HEAT COVERAGE AREA: 5'x6' (30 sq.ft.)

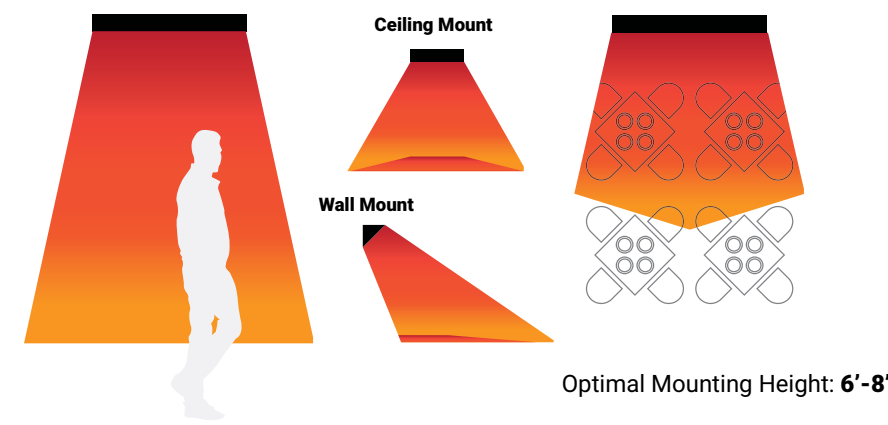

SPECIFICATIONS

WATTAGE	1500 Watts
SERIES	EF15
VOLTAGE RATING	120V
TOTAL AMPS	12.5A
FINISH	Black, Stainless Steel, White, Custom
CONSTRUCTION	Stainless Steel (304 SS)
HEATING AREA (Approximate)	5'x6' (30 sq.ft.)
COMPATIBLE ELEMENTS	EF15120E
MOUNTING OPTIONS	Wall/ Ceiling/ Flush/ Pole*
MOUNTING ANGLE (Wall/Ceiling)	30°/45°
MOUNTING ANGLE (Pole)	0°/15°/30°/45°/60°
LENGTH	39.37"
HEIGHT	8.1875"
DEPTH (With 6.36" Brackets)	9.36" (6.36"+3")
WEIGHT	9.4 LBS
INFRARED HEAT TECHNOLOGY	MEDIUM WAVE
IPX RATING	IPX4
WARRANTY	3 year

Actual output wattage ranging 90% to 105% of the rated output wattage.

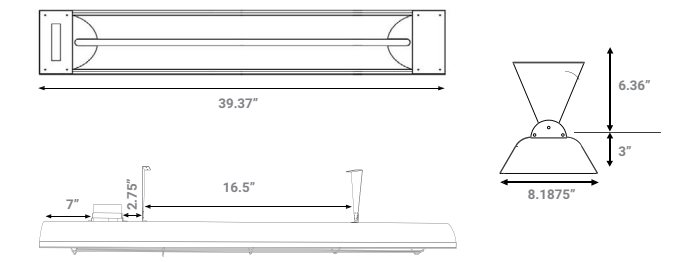

Radiant Warmth, Unmatched Quality

EF20

39" 2000 WATT ELECTRIC SINGLE QUARTZ ELEMENT HEATER

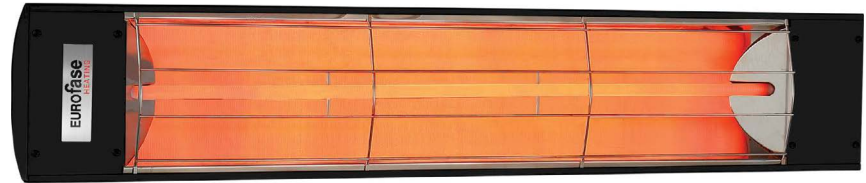

FEATURES

The perfect blend of functionality and aesthetics can elevate any outdoor area. Offering a lifestyle experience, these heaters are remarkably precise and versatile. The Eurofase 2000 Watt heater warms an approximate 6 x 6 foot area and is advised to be installed no higher than 8 feet off the ground. Eurofase provides the EF20 series in a standard Black, Stainless Steel or White finish and offers the option to upgrade a custom finish to complement any patio decor.

HEAT COVERAGE AREA: 6'x6' (36 sq.ft.)

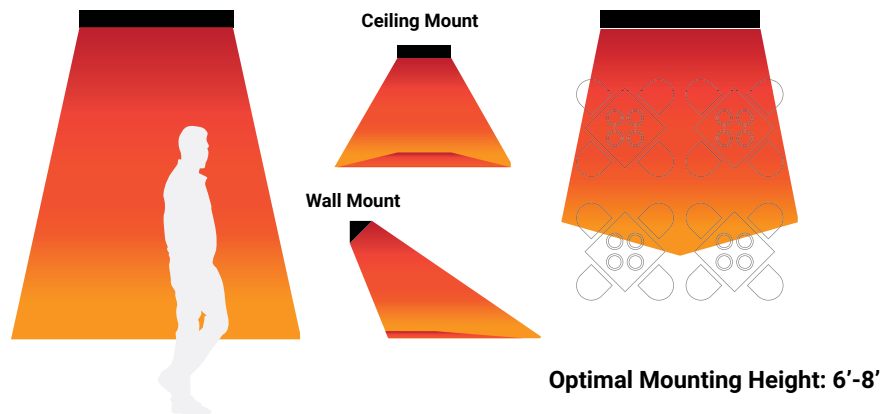

SPECIFICATIONS

WATTAGE	2000 Watts
SERIES	EF20
VOLTAGE RATING	208V, 240V, 277V, 480V
TOTAL AMPS	9.6A**, 8.3A, 7.2A, 4.2A**
FINISH	Black, Stainless Steel, White, Custom
CONSTRUCTION	Stainless Steel (304 SS)
HEATING AREA (Approximate)	6'x6' (36 sq.ft.)
COMPATIBLE ELEMENTS	EF20208E, EF20240E, EF20277E, EF20480E
MOUNTING OPTIONS	Wall/ Ceiling/ Flush/ Pole*
MOUNTING ANGLE (Wall/Ceiling)	30°/45°
MOUNTING ANGLE (Pole)	0°/15°/30°/45°/60°
LENGTH	39.37"
HEIGHT	8.1875"
DEPTH (With 6.36" Brackets)	9.36" (6.36"+3")
WEIGHT	9.4 LBS
INFRARED HEAT TECHNOLOGY	MEDIUM WAVE
IPX RATING	IPX4
WARRANTY	3 year

Actual output wattage ranging 90% to 105% of the rated output wattage.
** Load calculation may change on a 3-phase system feed.

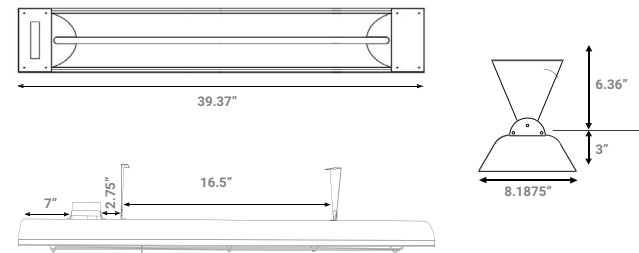

EF25

39" 2500 WATT ELECTRIC SINGLE QUARTZ ELEMENT HEATER

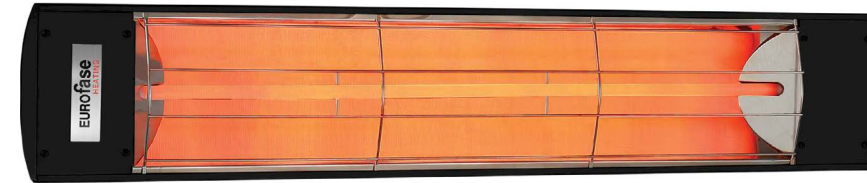

FEATURES

The perfect blend of functionality and aesthetics can elevate any outdoor area. Offering a lifestyle experience, these heaters are remarkably precise and versatile. The Eurofase 2500 Watt heater warms an approximate 7 x 7 foot area and is advised to be installed no higher than 9 feet off the ground. Eurofase provides the EF25 series in a standard Black, Stainless Steel or White finish and offers the option to upgrade a custom finish to complement any patio decor.

HEAT COVERAGE AREA: 7'x7' (49 sq.ft.)

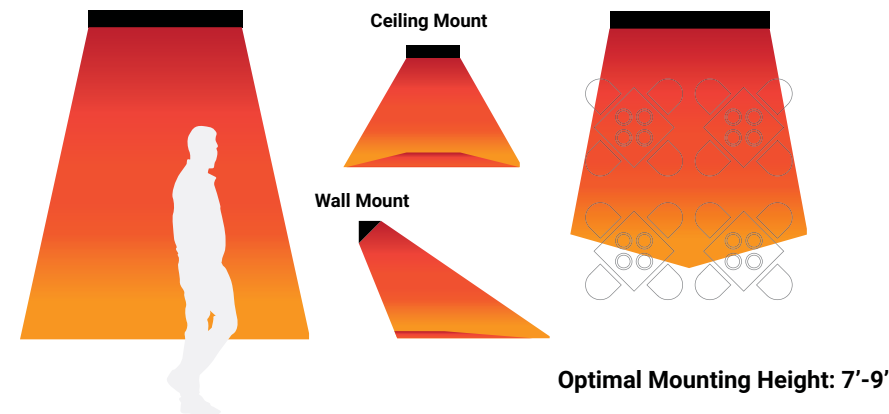

SPECIFICATIONS

WATTAGE	2500 Watts
SERIES	EF25
VOLTAGE RATING	208V, 240V, 277V, 480V
TOTAL AMPS	12A**, 10.4A, 9A, 5.2A**
FINISH	Black, Stainless Steel, White, Custom
CONSTRUCTION	Stainless Steel (304 SS)
HEATING AREA (Approximate)	7'x7' (49 sq.ft.)
COMPATIBLE ELEMENTS	EF25208E, EF25240E, EF25277E, EF25480E
MOUNTING OPTIONS	Wall/ Ceiling/ Flush/ Pole*
MOUNTING ANGLE (Wall/Ceiling)	30°/45°
MOUNTING ANGLE (Pole)	0°/15°/30°/45°/60°
LENGTH	39.37"
HEIGHT	8.1875"
DEPTH (With 6.36" Brackets)	9.36" (6.36"+3")
WEIGHT	9.4 LBS
INFRARED HEAT TECHNOLOGY	MEDIUM WAVE
IPX RATING	IPX4
WARRANTY	3 year

Actual output wattage ranging 90% to 105% of the rated output wattage.
** Load calculation may change on a 3-phase system feed.

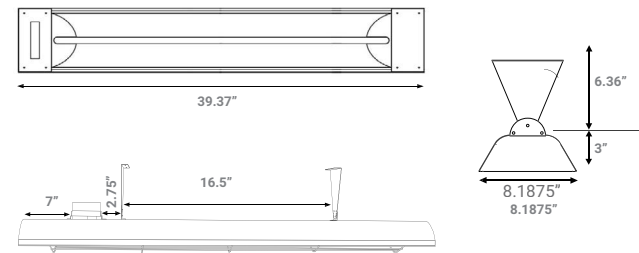

EF30

61" 3000 WATT ELECTRIC SINGLE QUARTZ ELEMENT HEATER

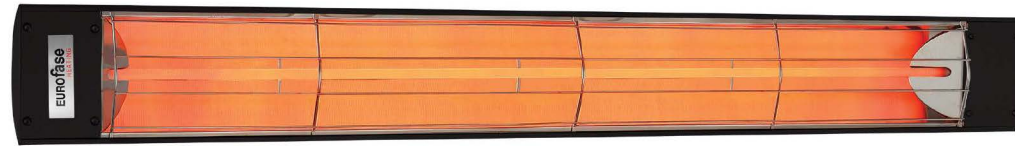

Color Options 

FEATURES

The perfect blend of functionality and aesthetics can elevate any outdoor area. Offering a lifestyle experience, these heaters are remarkably precise and versatile. The Eurofase 3000 Watt heater warms an approximate 8 x 8 foot area and is advised to be installed no higher than 9 feet off the ground. Eurofase provides the EF30 series in a standard Black, Stainless Steel or White finish and offers the option to upgrade a custom finish to complement any patio decor.

HEAT COVERAGE AREA: 8'x8' (64 sq.ft.)

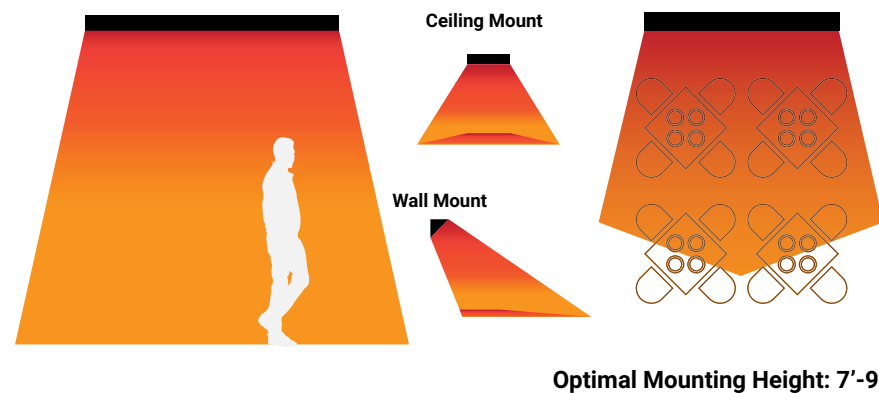

SPECIFICATIONS

WATTAGE	3000 Watts
SERIES	EF30
VOLTAGE RATING	208V, 240V, 277V, 480V
TOTAL AMPS	14.4A**, 12.5A, 10.8A, 6.25A**
FINISH	Black, Stainless Steel, White, Custom
CONSTRUCTION	Stainless Steel (304 SS)
HEATING AREA (Approximate)	8'x8' (64 sq.ft.)
COMPATIBLE ELEMENTS	EF30208E, EF30240E, EF30277E, EF30480
MOUNTING OPTIONS	Wall/ Ceiling/ Flush/ Pole*
MOUNTING ANGLE (Wall/Ceiling)	30°/45°
MOUNTING ANGLE (Pole)	0°/15°/30°/45°/60°
LENGTH	61.25"
HEIGHT	8.1875"
DEPTH (With 6.36" Brackets)	9.36" (6.36"+3")
WEIGHT	14.8 LBS
INFRARED HEAT TECHNOLOGY	MEDIUM WAVE
IPX RATING	IPX4
WARRANTY	3 year

Actual output wattage ranging 90% to 105% of the rated output wattage.
** Load calculation may change on a 3-phase system feed.

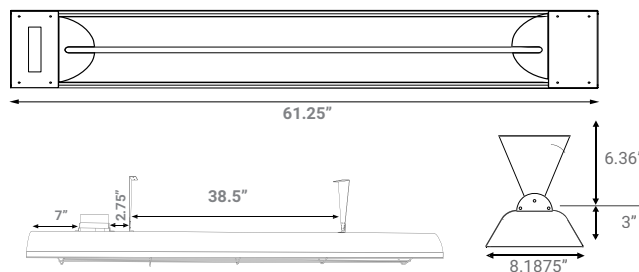

EF40

39" 4000 WATT ELECTRIC DUAL QUARTZ ELEMENT HEATER



Color Options 

FEATURES

The perfect blend of functionality and aesthetics can elevate any outdoor area. Offering a lifestyle experience, these heaters are remarkably precise and versatile. The Eurofase 4000 Watt heater warms an approximate 8 x 10 foot area and is advised to be installed no higher than 10 feet off the ground. Eurofase provides the EF40 series in a standard Black, Stainless Steel or White finish and offers the option to upgrade a custom finish to complement any patio decor.

HEAT COVERAGE AREA: 8'x10' (80 sq.ft.)

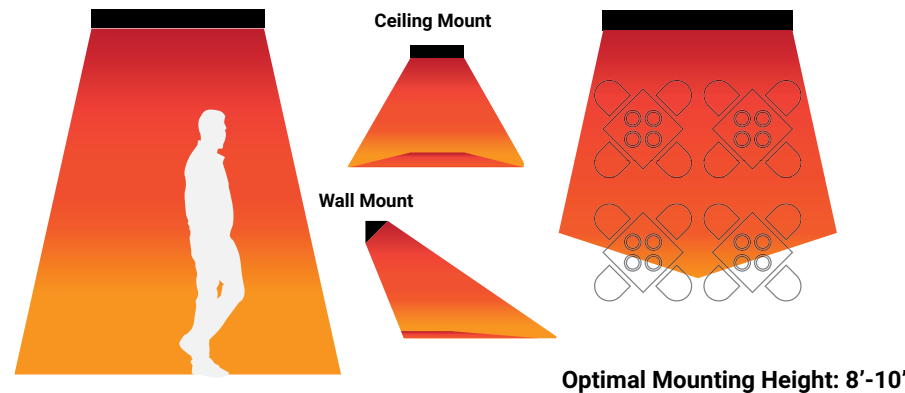

SPECIFICATIONS

WATTAGE	4000 Watts
SERIES	EF40
VOLTAGE RATING	208V, 240V, 277V, 480V
TOTAL AMPS	19.2A**, 16.7A, 14.4A, 8.33A**
FINISH	Black, Stainless Steel, White, Custom
CONSTRUCTION	Stainless Steel (304 SS)
HEATING AREA (Approximate)	8'x10' (80 sq.ft.)
COMPATIBLE ELEMENTS	EF20208E, EF20240E, EF20277E, EF20480E
MOUNTING OPTIONS	Wall/ Ceiling/ Flush/ Pole*
MOUNTING ANGLE (Wall/Ceiling)	30°/45°
MOUNTING ANGLE (Pole)	0°/15°/30°/45°/60°
LENGTH	39.37"
HEIGHT	8.1875"
DEPTH (With 6.36" Brackets)	9.36" (6.36"+3")
WEIGHT	10.5 LBS
INFRARED HEAT TECHNOLOGY	MEDIUM WAVE
IPX RATING	IPX4
WARRANTY	3 year

Actual output wattage ranging 90% to 105% of the rated output wattage.
** Load calculation may change on a 3-phase system feed.

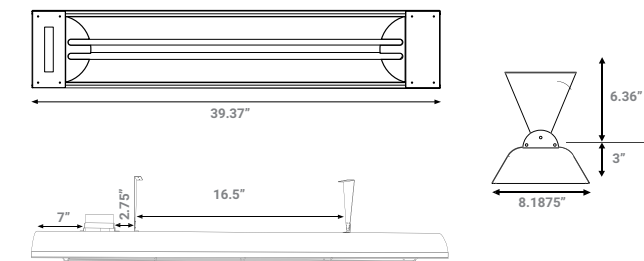

EF50

39" 5000 WATT ELECTRIC DUAL QUARTZ ELEMENT HEATER



FEATURES

The perfect blend of functionality and aesthetics can elevate any outdoor area. Offering a lifestyle experience, these heaters are remarkably precise and versatile. The Eurofase 5000 Watt heater warms an approximate 9 x 10 foot area and is advised to be installed no higher than 10 feet off the ground. Eurofase provides the EF50 series in a standard Stainless Steel, Black or White finish and offers the option to upgrade a custom finish to complement any patio decor.

HEAT COVERAGE AREA: 9'x10' (90 sq.ft.)

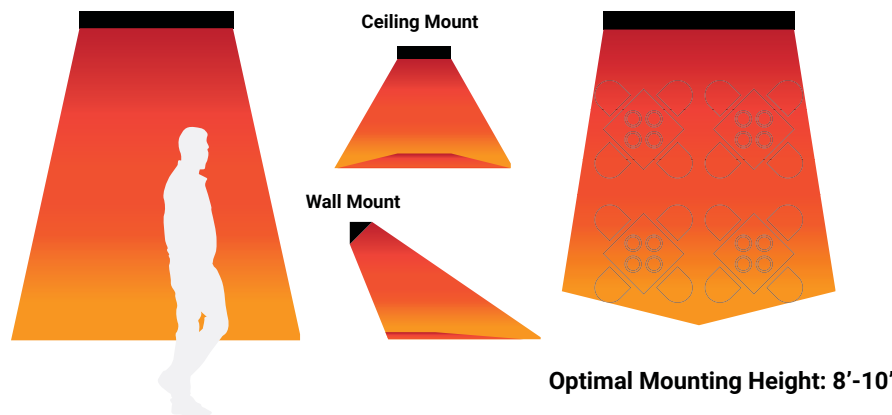

SPECIFICATIONS

WATTAGE	5000 Watts
SERIES	EF50
VOLTAGE RATING	208V, 240V, 277V, 480V
TOTAL AMPS	24A**, 20.8A, 18.1A, 10.4A**
FINISH	Black, Stainless Steel, White, Custom
CONSTRUCTION	Stainless Steel (304 SS)
HEATING AREA (Approximate)	9'x10' (90 sq.ft.)
COMPATIBLE ELEMENTS	EF25208E, EF25240E, EF25277E, EF25480E
MOUNTING OPTIONS	Wall/ Ceiling/ Flush/ Pole*
MOUNTING ANGLE (Wall/Ceiling)	30°/45°
MOUNTING ANGLE (Pole)	0°/15°/30°/45°/60°
LENGTH	39.37"
HEIGHT	8.1875"
DEPTH (With 6.36" Brackets)	9.36" (6.36"+3")
WEIGHT	10.5 LBS
INFRARED HEAT TECHNOLOGY	MEDIUM WAVE
IPX RATING	IPX4
WARRANTY	3 year

Actual output wattage ranging 90% to 105% of the rated output wattage.
** Load calculation may change on a 3-phase system feed.

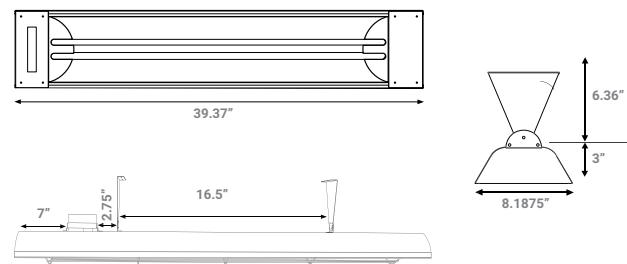

EF60

61" 6000 WATT ELECTRIC DUAL QUARTZ ELEMENT HEATER



FEATURES

The perfect blend of functionality and aesthetics can elevate any outdoor area. Offering a lifestyle experience, these heaters are remarkably precise and versatile. The Eurofase 6000 Watt heater warms an approximate 11 x 11 foot area and is advised to be installed no higher than 12 feet off the ground. Eurofase provides the EF60 series in a standard Stainless Steel, Black or White finish and offers the option to upgrade a custom finish to complement any patio decor.

HEAT COVERAGE AREA: 11'x11' (121 sq.ft.)

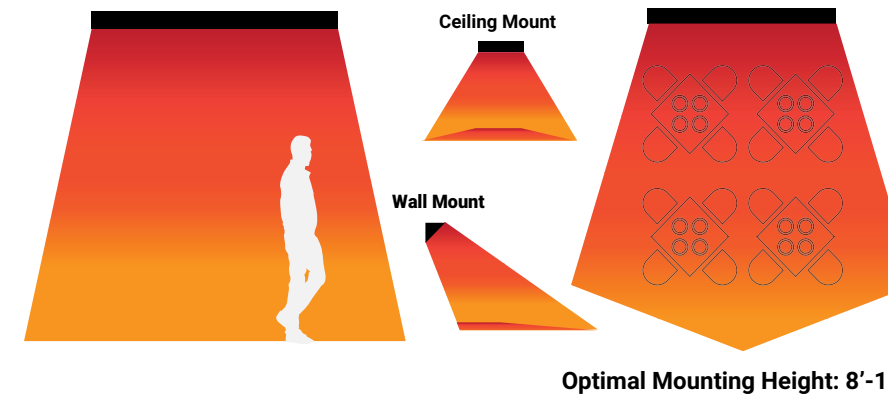

SPECIFICATIONS

WATTAGE	6000 Watts
SERIES	EF60
VOLTAGE RATING	208V, 240V, 277V, 480V
TOTAL AMPS	28.8A**, 25A, 21.7A, 12.5A**
FINISH	Black, Stainless Steel, White, Custom
CONSTRUCTION	Stainless Steel (304 SS)
HEATING AREA (Approximate)	11'x11' (121sq.ft.)
COMPATIBLE ELEMENTS	EF30208E, EF30240E, EF30277E, EF30480E
MOUNTING OPTIONS	Wall/ Ceiling/ Flush/ Pole*
MOUNTING ANGLE (Wall/Ceiling)	30°/45°
MOUNTING ANGLE (Pole)	0°/15°/30°/45°/60°
LENGTH	61.25"
HEIGHT	8.1875"
DEPTH (With 6.36" Brackets)	9.36" (6.36"+3")
WEIGHT	14.8 LBS
INFRARED HEAT TECHNOLOGY	MEDIUM WAVE
IPX RATING	IPX4
WARRANTY	3 year

Actual output wattage ranging 90% to 105% of the rated output wattage.
** Load calculation may change on a 3-phase system feed.

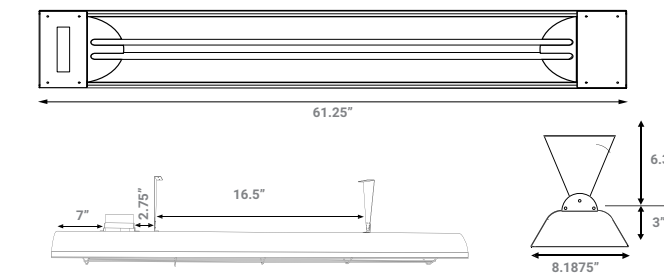

LP30

64" 3000 WATT ELECTRIC SINGLE QUARTZ ELEMENT HEATER



Color Options  

FEATURES

With a sleek, modern design, the Eurofase 3000 Watt Low Profile heater effortlessly blends into any space. Featuring quartz heating elements and 6-inch wall/ceiling brackets, it delivers warmth and comfort within a 8 x 8 foot area. Eurofase provides the LP30 series in a standard Black finish and offers the option to upgrade a custom finish to complement any patio decor.

HEAT COVERAGE AREA: 8'x8' (64 sq.ft.)

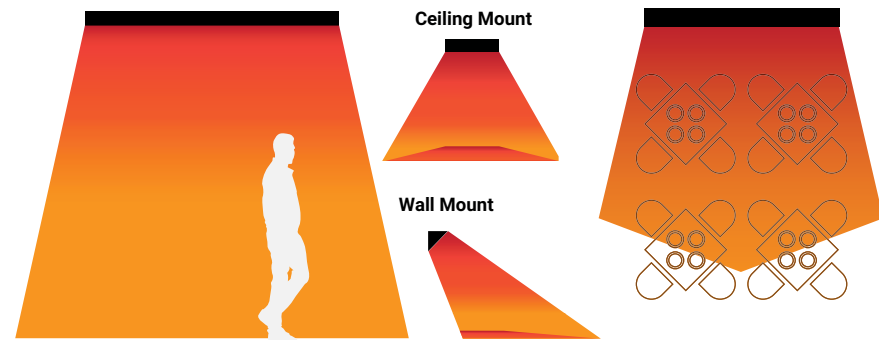

Optimal Mounting Height: 7'-9'

SPECIFICATIONS

WATTAGE	3000 Watts
SERIES	LP30
VOLTAGE RATING	208V, 240V, 277V, 480V
TOTAL AMPS	14.4A**, 12.5A, 10.8A, 6.25A**
FINISH	Black
CONSTRUCTION	Stainless Steel (304 SS)
HEATING AREA (Approximate)	8'x8' (64 sq.ft.)
COMPATIBLE ELEMENTS	EF30208E, EF30240E, EF30277E, EF30480E
MOUNTING OPTIONS	Wall/ Ceiling
MOUNTING ANGLE (Wall/Ceiling)	30°/45°
LENGTH	64.3"
HEIGHT	4.65"
DEPTH (With 6" Brackets)	9" (6"+3")
WEIGHT	17 LBS
INFRARED HEAT TECHNOLOGY	MEDIUM WAVE
IPX RATING	IPX4
WARRANTY	3 year

Actual output wattage ranging 90% to 105% of the rated output wattage.
** Load calculation may change on a 3-phase system feed.

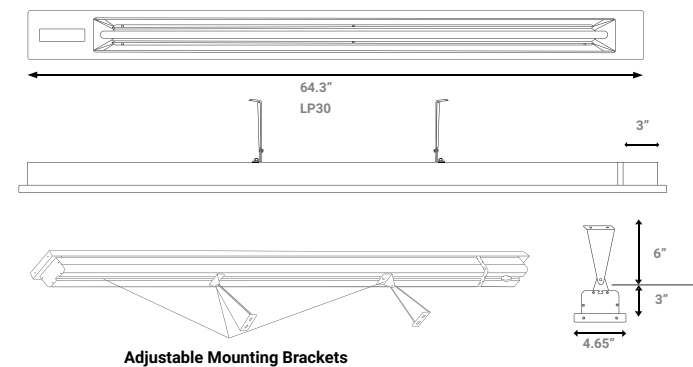

Adjustable Mounting Brackets

LP40

64" 4000 WATT ELECTRIC SINGLE QUARTZ ELEMENT HEATER



Color Options  

FEATURES

With a sleek, modern design, the Eurofase 4000 Watt Low Profile heater effortlessly blends into any space. Featuring quartz heating elements and 6-inch wall/ceiling brackets, it delivers warmth and comfort within a 10 x 10 foot area. Eurofase provides the LP40 series in a standard Black finish and offers the option to upgrade a custom finish to complement any patio decor.

HEAT COVERAGE AREA: 10'x10' (100 sq.ft.)

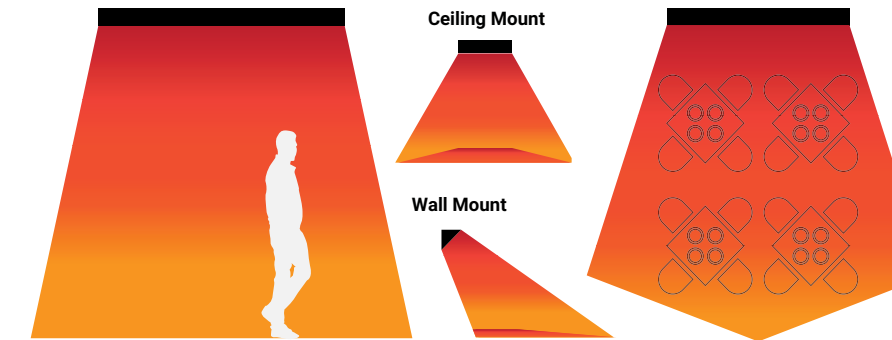

Optimal Mounting Height: 8'-10'

SPECIFICATIONS

WATTAGE	4000 Watts
SERIES	LP40
VOLTAGE RATING	208V, 240V, 277V, 480V
TOTAL AMPS	19.2A**, 16.7A, 14.4A, 8.33A**
FINISH	Black
CONSTRUCTION	Stainless Steel (304 SS)
HEATING AREA (Approximate)	10'x10' (100 sq.ft.)
COMPATIBLE ELEMENTS	EF40208E, EF40240E, EF40277E, EF40480E
MOUNTING OPTIONS	Wall/ Ceiling
MOUNTING ANGLE (Wall/Ceiling)	30°/45°
LENGTH	64.3"
HEIGHT	4.65"
DEPTH (With 6" Brackets)	9" (6"+3")
WEIGHT	17 LBS
INFRARED HEAT TECHNOLOGY	MEDIUM WAVE
IPX RATING	IPX4
WARRANTY	3 year

Actual output wattage ranging 90% to 105% of the rated output wattage.
** Load calculation may change on a 3-phase system feed.

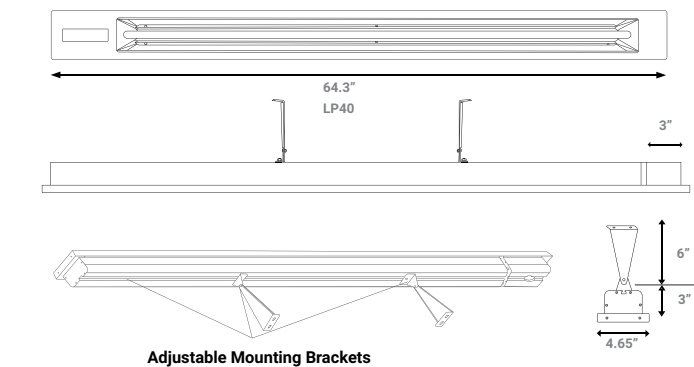

Adjustable Mounting Brackets



Sleek Design and Maximum Comfort

DÉCOR PLATES

COLOR LEGEND

- Black
- White
- Stainless Steel
- Any RAL color

*Any RAL color available for most décor plates. Refer to page 19.

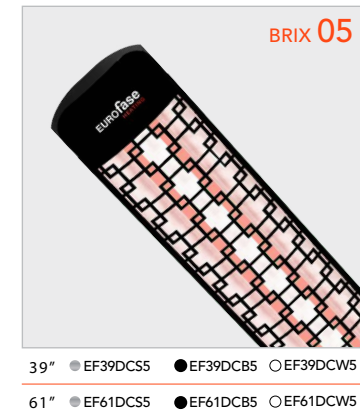



We Do Custom

At Eurofase Heating, we aim to provide you with purposeful products that will add more value to your space, expanding your range outdoors.

We not only want to provide you with a heater that fits in your space, but we also want to make sure it belongs there. Eurofase's team can help you customize the heater décor plates with our metal laser cutting capabilities that can produce special shapes and letterings to spark your uniqueness.

Eurofase Heating takes pride in our designs and stands at the forefront of innovation, passion, providing our customers with exactly what they need.

It's Up To Hue

Our customization abilities do not end at metal laser cutting of décor plates. With our resources, we can accommodate a large assortment of custom colors to visually enhance your space based on your needs.

From the design concept to product engineering, Eurofase Heating can manufacture and produce your custom design.

Get in touch with one of our dealers to get your Eurofase heater customized.



5 Years Southern Florida Sun Rating.
Powder Coat finishes are super high durable for exterior coating protection.



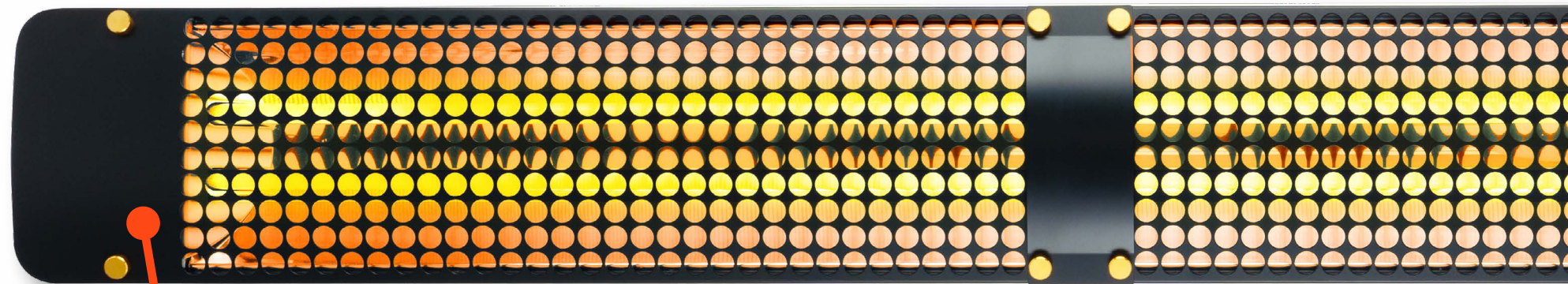

Inspired by the Eurofase Admiral's metal rivet accents & filigreed metal design

Detailed metal rivet accents & filigreed metal design completes the aesthetics of the Admiral



By the way...

Did you realize that Eurofase heating décor plate designs take cues from the aesthetics of Eurofase's lighting fixtures?

For smooth integration and a harmonious design of your space, combine our lighting to stay warm and cozy outside, while staying in style.

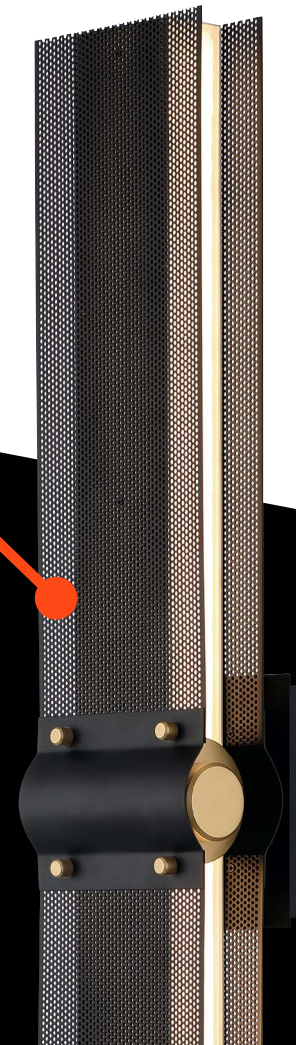

Complete Your Setup with Our Accessories



FLUSH MOUNT KIT

Ideal for both indoor and outdoor applications in commercial or residential settings and crafted from durable 304 stainless steel, it is built to withstand the elements, ensuring long-lasting performance.

Eurofase provides these Flush Mount Kits in a standard Black, Stainless Steel or White finish and offers the option to upgrade a custom finish to complement any patio decor.

- Note: The flush mount Kit comes with:
- Flush Mount Frame
 - A 4' 4-wire High Temperature Whip
 - Brackets and other mounting accessories

FINISH	EF15, EF20, EF25, EF40, EF50	EF60, EF30
STAINLESS STEEL	EF39FMPFS	EF61FMPFS
BLACK	EF39FMPFB	EF61FMPFB
WHITE	EF39FMPFW	EF61FMPFW
MARINE GRADE STAINLESS STEEL	EF39FMPFSMG	EF61FMPFSMG



HIGH TEMP. WHIP

As one of the leading manufactures of infrared heaters, Eurofase Heating continues to innovate and bring solutions to the industry. Available in multiple lengths, our 4-wire high temperature whip is resistant to rust, cracks and heat damage.

SUSPENSION KIT

Enhance your design options with Eurofase's Suspension Kit, an ideal choice for spaces featuring high or sloped ceilings. Specifically crafted for flexible installations, this solution caters to various ceiling types, particularly in areas where heaters are placed above the 12-foot threshold.



Did you know...

For optimal heat coverage, we recommend installing the heater between 8ft to a maximum of 12ft. In cases of higher ceiling applications or slope ceilings, it is advisable to use the suspension kit for proper positioning.

ITEM NO.	EF15, EF20, EF25, EF40, EF50
EFSMKB	26 INCH TO 48 INCH TELESCOPING MOUNTING KIT
EFSMKBEXT66	66 INCH EXTENSION KIT FOR TELESCOPING MOUNTING KIT

ITEM NO.	DESCRIPTION
EFHTW10	10'4-WIRE HIGH TEMPERATURE WHIP
EFHTW15	15'4-WIRE HIGH TEMPERATURE WHIP
EFHTW20	20'4-WIRE HIGH TEMPERATURE WHIP
EFHTW30	30'4-WIRE HIGH TEMPERATURE WHIP
EFHTW40	40'4-WIRE HIGH TEMPERATURE WHIP
EFHTW50	50'4-WIRE HIGH TEMPERATURE WHIP
EFHTW75	75'4-WIRE HIGH TEMPERATURE WHIP



8' Single Pole Mount for EF Series heaters in Black

8' Double Pole Mount for EF Series heaters in White

POLE MOUNT

The pole mount option from Eurofase Heating is an excellent way to direct heat when wall or ceiling mounting is not an option. Standing 8' high, Eurofase Heating offers a single and double mount that can be angled to 0°/15°/30°/45°/60° degrees to ensure you get the perfect angle.

ITEM NO.	DESCRIPTION
EF3908PMW	8' POLE MOUNT, SINGLE 39", WHITE
EF3908PMB	8' POLE MOUNT, SINGLE 39", BLACK
EF6108PMW	8' POLE MOUNT, SINGLE 61", WHITE
EF6108PMB	8' POLE MOUNT, SINGLE 61", BLACK
EF3908PMDW	8' POLE MOUNT, DOUBLE 39", WHITE
EF3908PMDB	8' POLE MOUNT, DOUBLE 39", BLACK
EF6108PMDW	8' POLE MOUNT, DOUBLE 61", WHITE
EF6108PMDB	8' POLE MOUNT, DOUBLE 61", BLACK

*Custom sizes and colors available. Please contact us to know more.



DUST COVER

Ensure your patio heater stays in prime condition with our weather-resistant dust covers. Crafted from durable materials, these covers offer robust protection against dust, dirt, rain, and snow, safeguarding your investment and prolonging its lifespan. With secure closures and a snug fit, our covers provide peace of mind, allowing you to enjoy your outdoor heating experience with confidence year after year.

ITEM NO.	DESCRIPTION
EF39CVRB	39 INCH NYLON PATIO HEATER COVER
EF61CVRB	61 INCH NYLON PATIO HEATER COVER

Installation Tip...

Prior to covering your heater with the dust cover, ensure that you switch off the breakers for safety precautions.



ON/OFF SWITCHES

Eurofase's on/off switches are crafted with meticulous engineering to provide precision and reliability, offering effortless control over your heaters. What sets our switches apart is their exceptional versatility, offering outdoor weatherproof covers in both recessed and surface mount options. Designed for durability, these covers are built to withstand the challenges of outdoor environments, protecting your switches from rain, snow, dust, and other environmental elements.

All switches are available in both stainless steel and white.

Did you know...

You have the option to upgrade to our universal relay control box, which unlocks additional functionality such as timer settings, variant heat control, and thermostat capabilities.

SINGLE AND DUAL DUPLEX SWITCHES



SKU#: EFSSPS1



SKU#: EFSSPW2



SKU#: EFSWPS



SKU#: EFDWPW

WEATHERPROOF SURFACE & RECESSED SWITCHES



SKU#: EFSOWPS



SKU#: EFDOWPW



SKU#: EFSWWPS



SKU#: EFDWWPW

Take Control of Your Outdoor Living

SMART WIFI CONTROL



Works with Eurofase app



- On/Off switch
- Timer
- Manage multiple heaters



Transform any patio heater into a smart device with the Eurofase Heating WiFi controller! Effortlessly switch your heaters on or off and schedule timers using your iPhone or Android device. Whether it's a new installation or retrofit, the Eurofase WiFi controller adds convenience to your outdoor heating experience.

SPECIFICATIONS

ITEM NO.	EFIKWSM
COLOR	Light Grey
INPUT VOLTAGE	240V
MAX. AMPERAGE	25A
WIRELESS COMMUNICATION	Wifi, Bluetooth
MOUNTING TYPE	Surface mount
HEIGHT	5"
LENGTH	10"
WIDTH	3"
ENCLOSURE RATING	IP65
WARRANTY	3 year

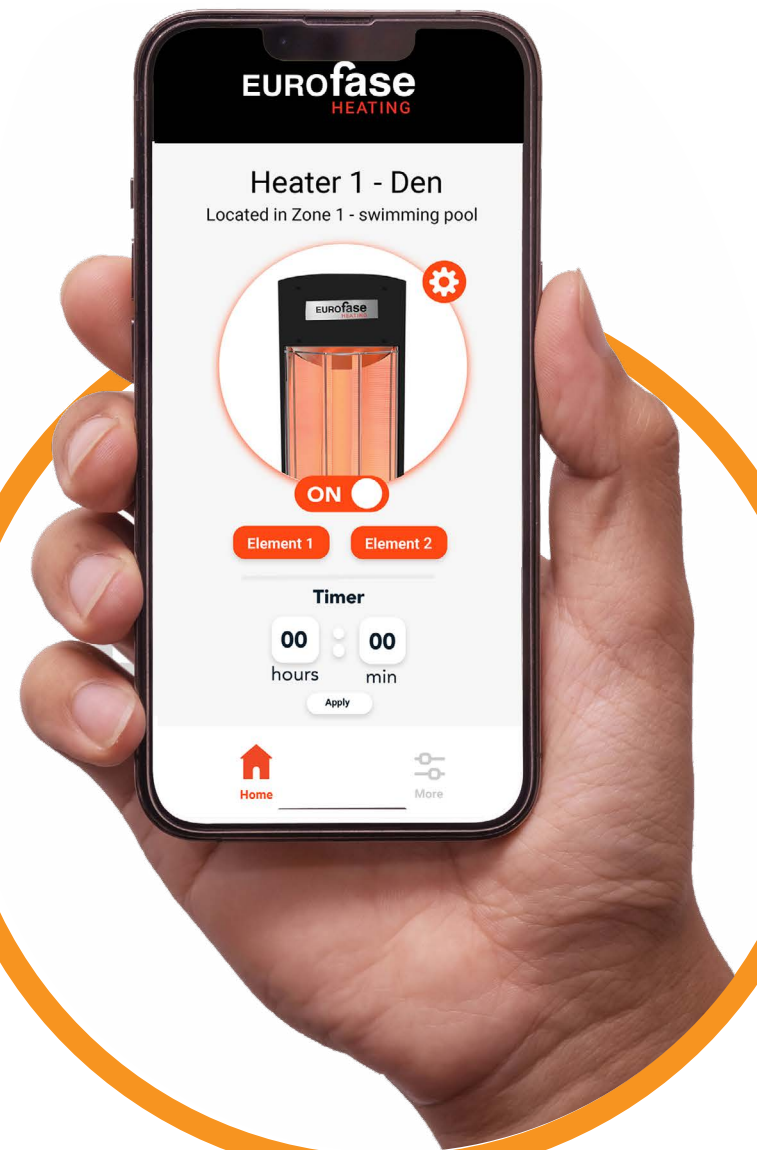
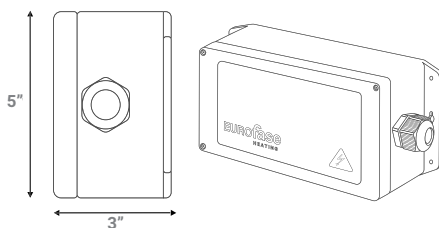
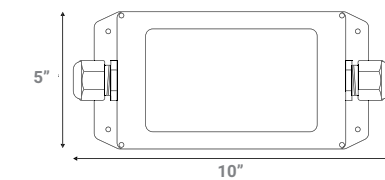

CONTACTOR BOX

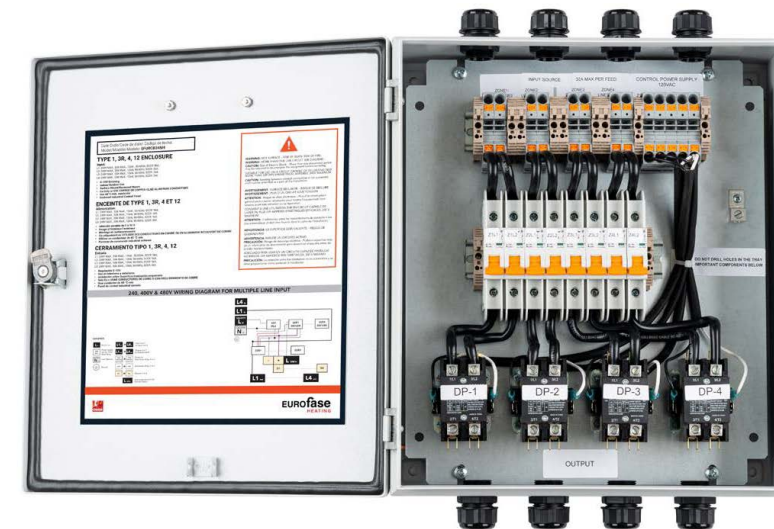

The Contactor panel is suitable for all Eurofase Heaters and can be matched with either a Eurofase single paddle on/off switch or a Eurofase timer. It allows seamless integration of other 120V or 277V controls, including timers, thermostats or smart switches.

ITEM NO.	DESCRIPTION
EFCB24M1	120V-240V MULTI INPUT, 1 ZONE
EFCB24M2	120V-240V MULTI INPUT, 2 ZONE
EFCB24M3	120V-240V MULTI INPUT, 3 ZONE
EFCB24M4	120V-240V MULTI INPUT, 4 ZONE
EFCB48M1	277V-480V MULTI INPUT, 1 ZONE
EFCB48M2	277V-480V MULTI INPUT, 2 ZONE
EFCB48M3	277V-480V MULTI INPUT, 3 ZONE
EFCB48M4	277V-480V MULTI INPUT, 4 ZONE

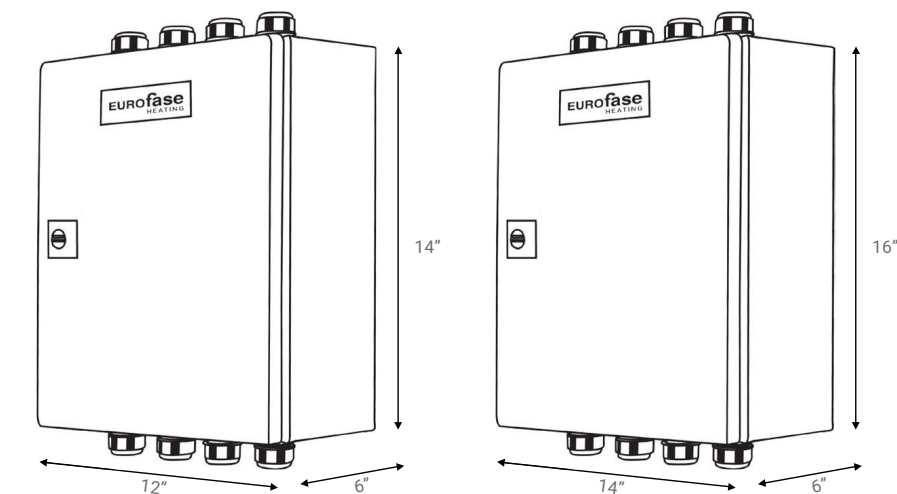

SPECIFICATIONS

SERIES	EFCB
COLOR	Light Grey
INPUT VOLTAGE	208V, 240V, 277V, 480V
ZONE CAPACITY	40A
MAX. AMPERAGE	160A
CONTROL VOLTAGE	120V
MOUNTING TYPE	Surface Mount
HEIGHT (1 and 2 Zone)	14"
HEIGHT (3 and 4 Zone)	16"
LENGTH (1 and 2 Zone)	12"
LENGTH (3 and 4 Zone)	14"
WIDTH	6"
ENCLOSURE RATING	NEMA 4
WARRANTY	3 year
COUNTRY OF ORIGIN	Canada

UNIVERSAL RELAY CONTROL BOX

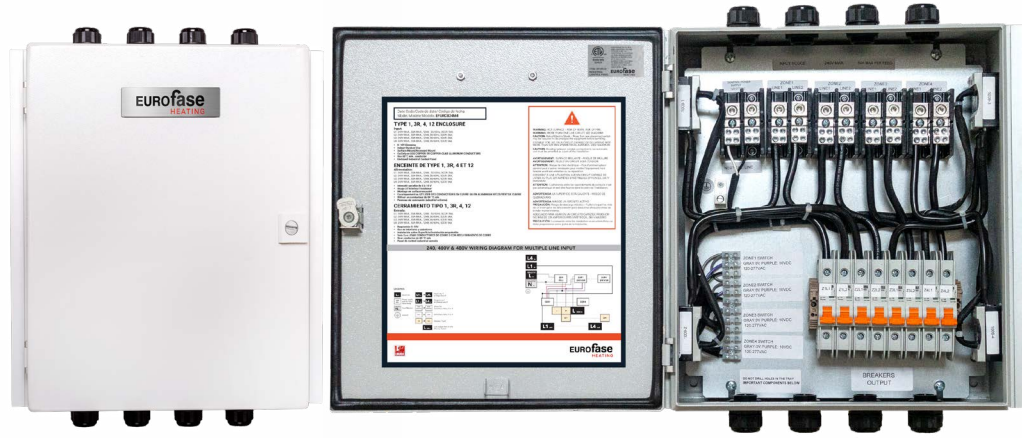

SPECIFICATIONS

SERIES	EFURCB
COLOR	Light Grey
INPUT VOLTAGE	208V, 240V, 277V, 480V
ZONE CAPACITY	50A
MAX. AMPERAGE	200A
CONTROL VOLTAGE	0V-10V DC
MOUNTING TYPE	Surface mount
HEIGHT (1 and 2 Zone)	14"
HEIGHT (3 and 4 Zone)	16"
WIDTH (1 and 2 Zone)	12"
WIDTH (3 and 4 Zone)	14"
DEPTH	6"
ENCLOSURE RATING	NEMA 4
WARRANTY	3 year
COUNTRY OF ORIGIN	Canada

The Eurofase Universal Relay Control Box makes managing your comfort zone easier. It helps control multiple heaters and furthermore, creates varied heat zones throughout your space. This control box is a highly recommended addition for commercial spaces like restaurant patios where customers have individual heat preferences. Modify each area with precise temperature conditions that are easily accessible and achievable with this control box.

Custom control boxes are available, please contact factory.

ITEM NO.	DESCRIPTION
EFURCB24M1	120V-240V MULTI INPUT, 1 ZONE
EFURCB24M2	120V-240V MULTI INPUT, 2 ZONE
EFURCB24M3	120V-240V MULTI INPUT, 3 ZONE
EFURCB24M4	120V-240V MULTI INPUT, 4 ZONE
EFURCB48M1	277V-480V MULTI INPUT, 1 ZONE
EFURCB48M2	277V-480V MULTI INPUT, 2 ZONE
EFURCB48M3	277V-480V MULTI INPUT, 3 ZONE
EFURCB48M4	277V-480V MULTI INPUT, 4 ZONE

Compatible with:

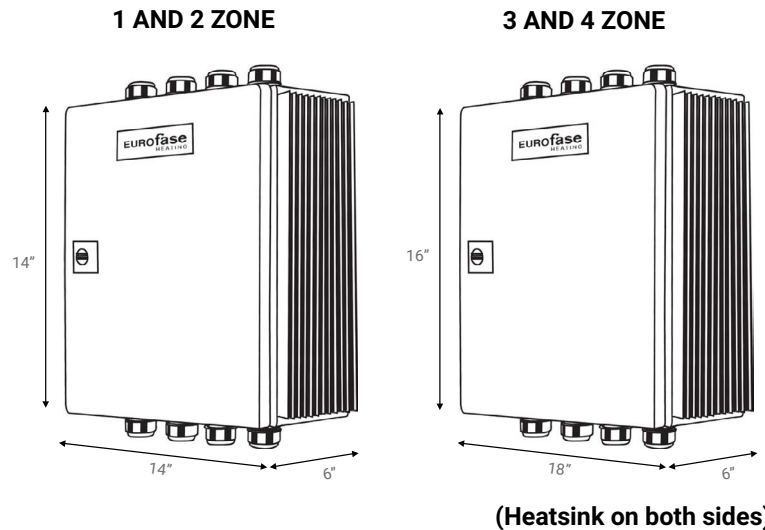

TIMERS & DIMMERS

At Eurofase Heating, we strive to provide our customers with the means to create a cozy, comfortable space with a single press. We make having a luxurious and relaxed environment easy with our controls so that you can enjoy your space no matter your preference.

All Eurofase heaters are compatible with timers, dimmers and a combination of both to give you the ability to optimize the infrared heatwaves emitted from our heaters (a control box is required to enable dimmer functionality). This helps you moderate the flow of heat from 0 to 100 percent along with giving you the absolute flexibility to choose how long you would like the heater to run.

Custom configurations (weather proof, surface mounted, etc.) are available.

TIMER (ONLY)



SKU#: EFSWT

DIMMER (ONLY)



SKU#: EFSWD

Good to know...

To ensure optimal performance and longevity of the heater, it is recommended to observe a 15-minute cool-down period after 4 hours of continuous usage. Our timers are specifically designed to contribute to optimal heater performance.

TIMER WITH DIMMER

(COMBINATIONS UP TO 1 TIMER + 4 DIMMERS)



SKU#: EFSWTD1



SKU#: EFSWTD2



SKU#: EFSWTD3



SKU#: EFSWTD4

CREATE YOUR SPACE

VISIT US ONLINE

Take control of your space with our user-friendly, drag-and-drop tools. Achieve the optimal layout by dragging and dropping the selected heater into your space to simulate the heat coverage.

eurofaseheating.com/createyourspace/

PRO TIP

It's better to slightly overheat a space than to underheat it. Choosing a slightly larger heater ensures better coverage, especially with infrared heaters that primarily heat people and objects.

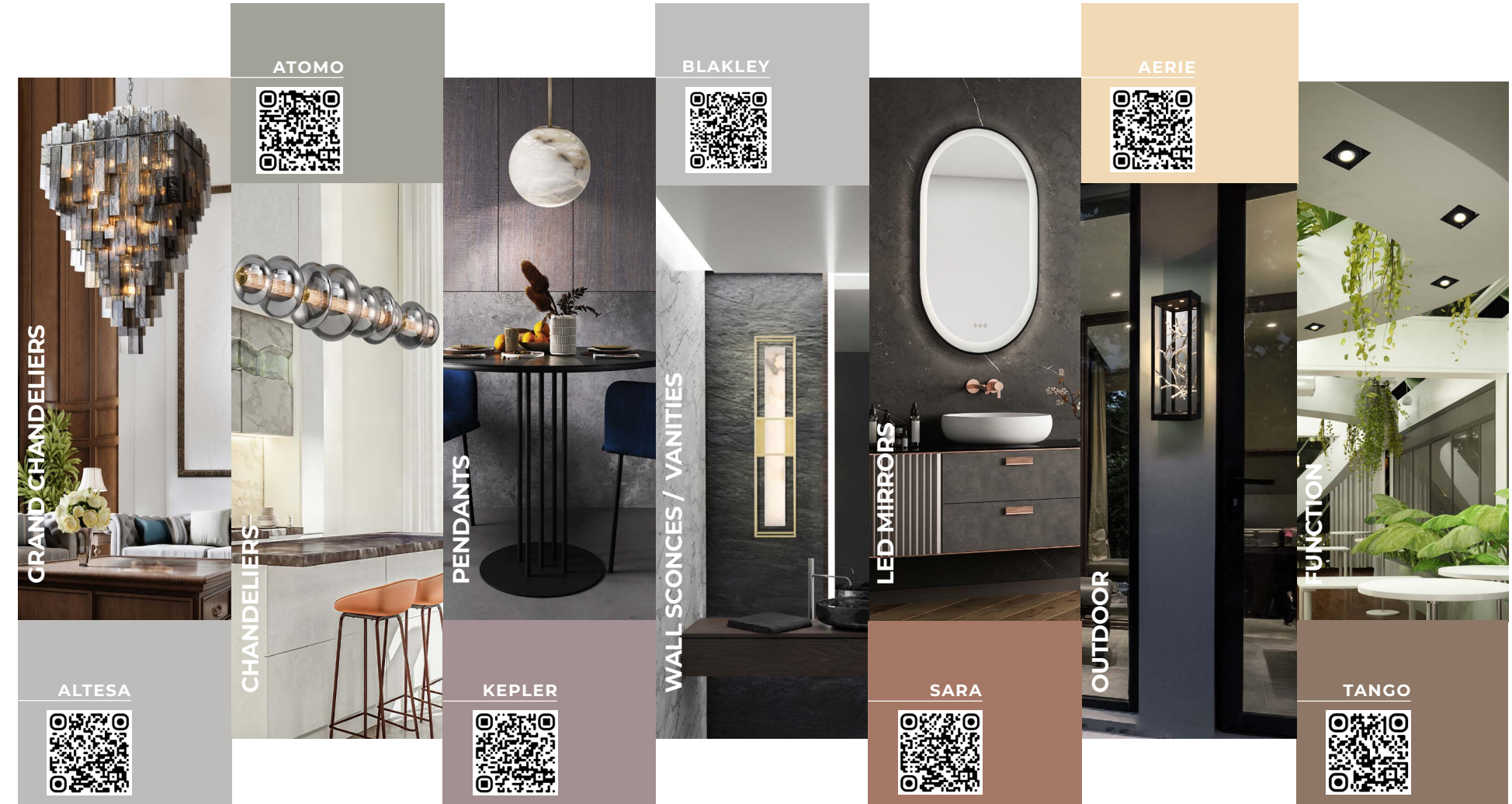
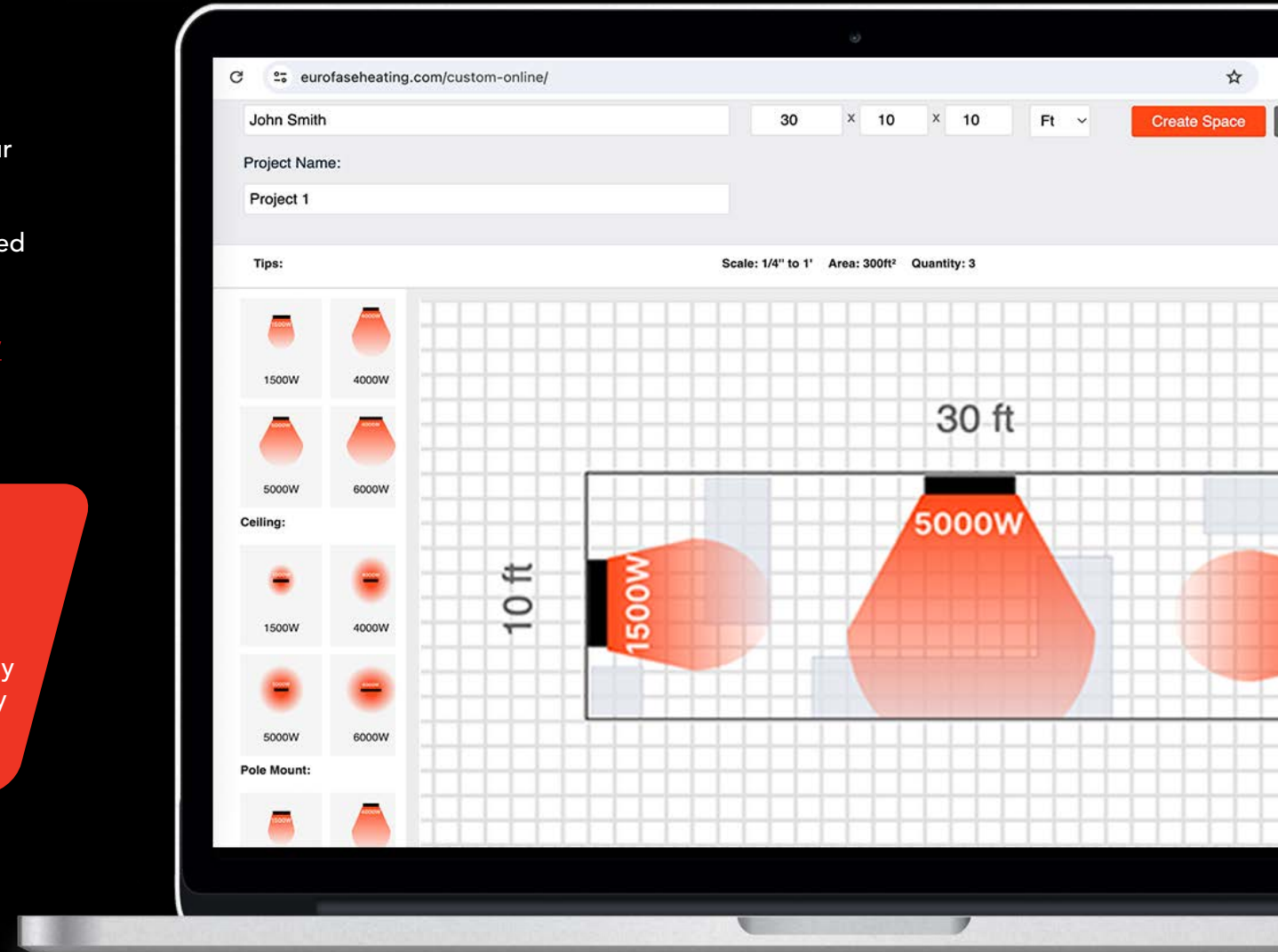

DESIGN VISION

Creativity (*forward thinking*), originality (*individuality*), influence (*social and environmental*), and excellence (*quality*), are the key design values of Eurofase.

These concepts support a perspective that shapes and symbolizes the fusion of lifestyle, luxury, and timelessness.

EUROfase
LIGHTING

EUROfase

HEATING

We are incredibly proud of our quality and craftsmanship and offer an industry-leading warranty on all our products. If your Eurofase Heating products ever disappoint, simply give us a shout and we will repair or replace our products within 3 years from the date of purchase.



33 West Beaver Creek,
Richmond Hill, ON L4B 1L8
info@eurofaseheating.com
T. 1-833-346-6682

DALLAS TRADE MART
Eurofase Showroom,
Suit #4002

EurofaseHeating.com