

KS75 Glass Barrier - Single Sided Gas Fireplace

Information Sheet for Builders and Architects

FIRE BY **escea.**

SPECIFICATIONS

Model No.	NCS7525
Gas Input (NG/Propane)	57,000 BTU-hr/57,000 BTU-hr
Heat Output (NG/Propane)	37,882 BTU-hr/39,296 BTU-hr
Gas Type	Natural Gas / Propane
Power Requirement	3 pin, 110/120V mains power
Appliance Weight	654.7 lbs
Finish Options	Frameless
Connections/Gas Connection	Right-hand side/Lower corner
Room Sealed Glass	Yes
Heat Duct System	Mandatory
Fireplace Chase Venting	Not Required
Clearance to Combustibles	Zero clearance from fireplace surfaces
Service Access Hatch	Not Required



Vent System	Power direct-vent with 4" x 6 5/8" vent pipe*
Vent Termination Locations	Roof or Wall mounted Terminations
Minimum Vent Length	24"
Maximum Vent Length	50' (600")
Vent Clearances to Combustibles	3" above vent, 1" to sides/below vent
Compliance	Certified to ANSI Z21.88/CSA 2.33

*Refer to the *Escea KS Series Power Vent Information Sheet*

INSTALLATION

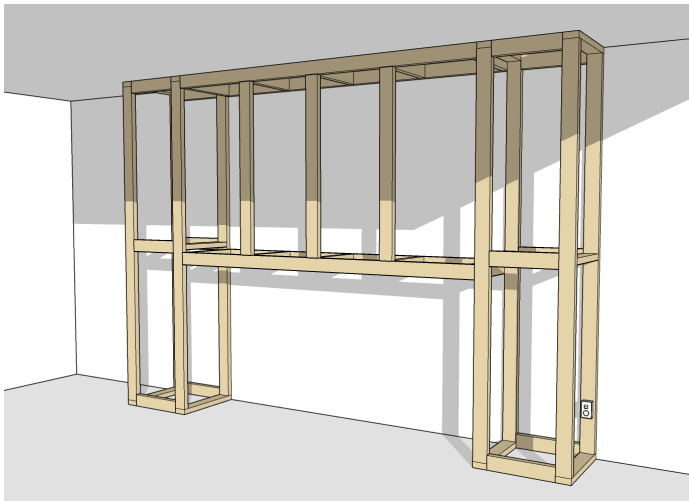

Construct the wood framing following all minimum fireplace chase opening requirements and with consideration to vent pathways. Provide a continuous base for the fireplace. Allow for mains power connection and an accessible isolation switch.

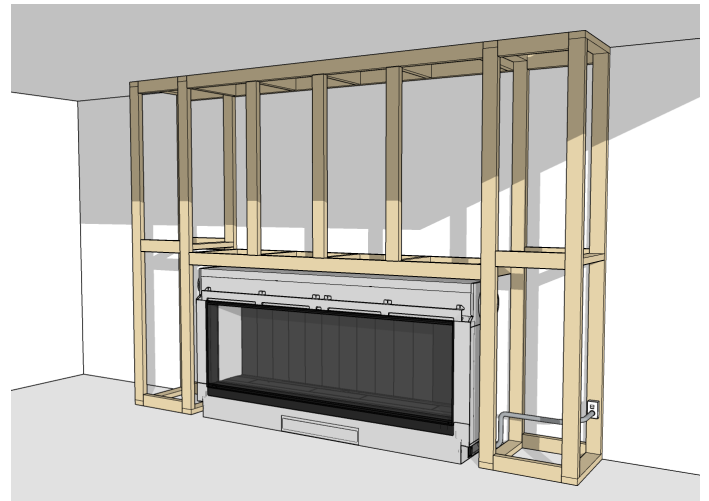

Install the appliance into the preformed opening in the chase. Secure to the framework using the supplied nailing flanges. The fireplace should be flush with the wood framing. Install the electrical connection and gas supply.

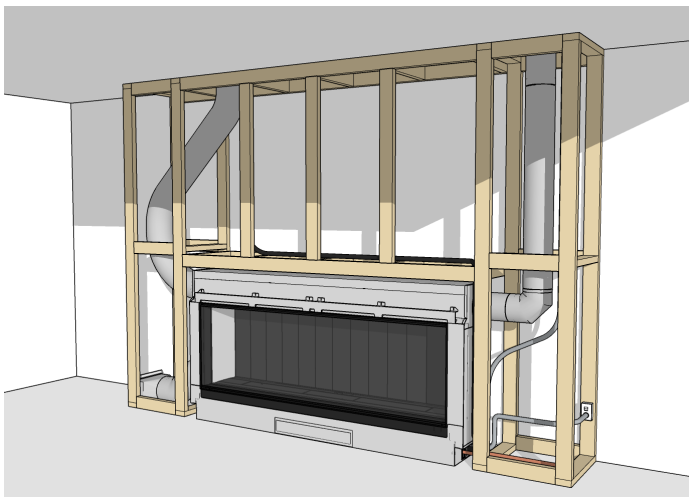

Connect the vent pipe to the fireplace and construct vent pathway to the vent termination. Connect Power-vent electrical supply from the fireplace to the vent termination. Install the heat duct system including the duct fan and duct fan electrical cable.

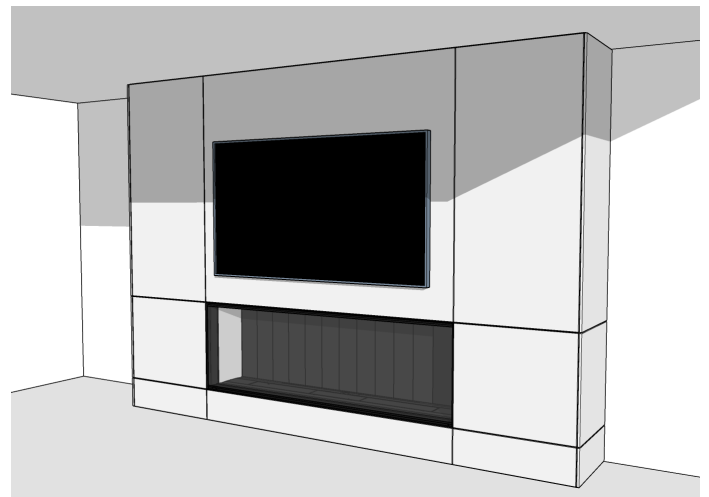

Fix the wall linings to the framework and the fireplace leaving a 1/4" gap to the glass opening. The wall lining can be bonded directly to the fireplace. Install any additional finishes or fixtures to complete the project.

KS75 Glass Barrier - Single Sided Gas Fireplace

FIRE BY **escea.**

Information Sheet for Builders and Architects

FIREPLACE DIMENSIONS

Fireplace Width	89 7/32"	Chase Opening Width min.	90"
Fireplace Height	42 29/32"	Chase Opening Height min.	44"
Fireplace Depth	17 19/32"	Chase Opening Depth min.	21 1/4"
Viewing Area Width	76 17/32"	Vent Chase Width min.	8"
Viewing Area Height	24 7/8"	Duct Vent Chase Width min.	19"

This fireplace should be installed in accordance with any local regulations or codes and the relevant Escea Install Manual. In the absence of local codes, install in accordance with ANSI Z223.1/NFPA 54, or CSA B149.1 and the relevant Escea Install Manual.

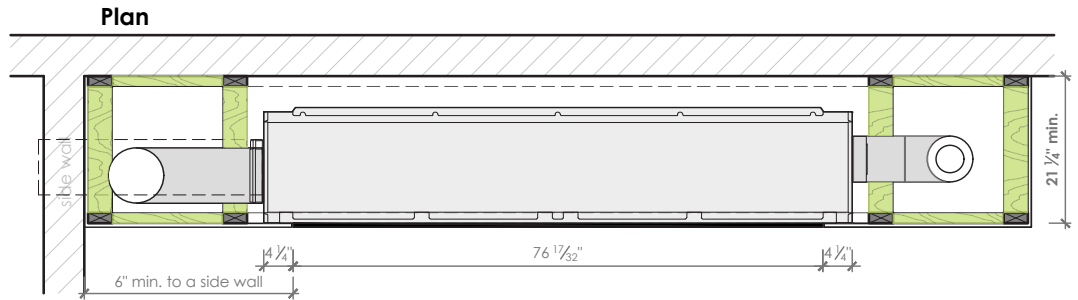

Side View

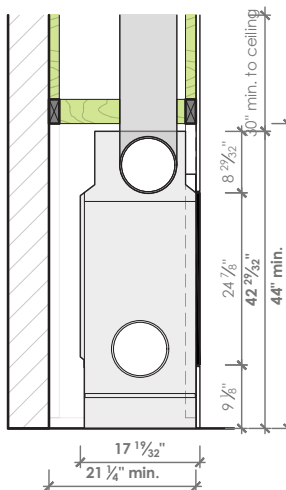

Front View

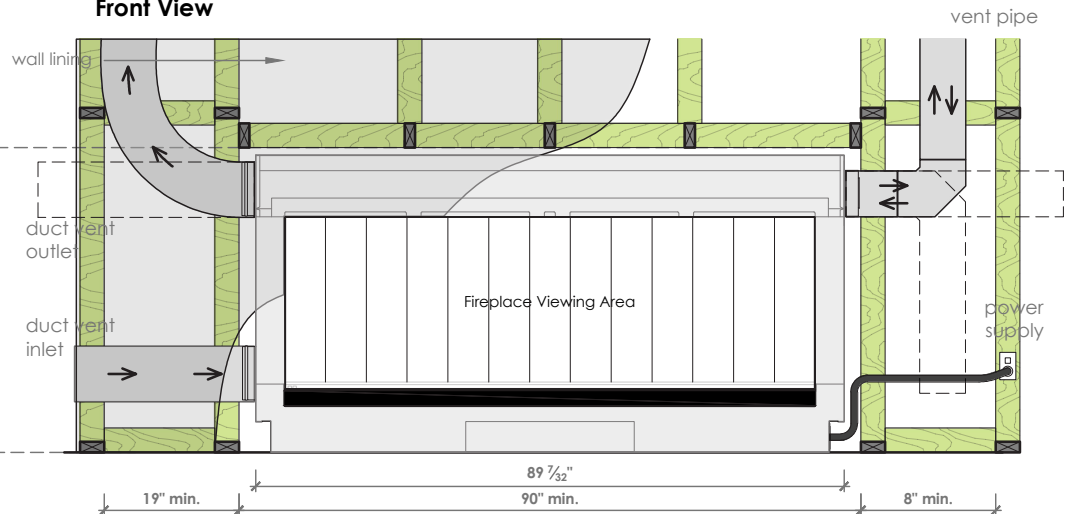

FIREPLACE LOCATION

A single sided gas fireplace allows for a multiple locations within a space or room. This could be as a room divider, against an external wall, an island, into a corner, or as a peninsula type installation. Consult the *Escea Cabinetry Design Guide* if the framework is at minimum cavity height for under-counter or built-in cabinets.

HEAT DUCT SYSTEM

The heat duct system circulates warm air from the fireplace throughout the room and beyond. It should not vent externally. It comprises an 8" vent pipe from the fireplace to the duct fan, followed by 10" flexible ducting to an outlet or splitter. When using splitters, employ 6" flexible ducting after the splitter. For details, check the *Escea KS Series Duct System Guide*. Ensure adequate support and restraint for the duct fan and pipework.

FINISHES

Use wall finishes of 3/8" to 3/4", either combustible or non-combustible. **Ensure combustible linings DO NOT extend past the finishing trim (5/8" depth) to the edge of the glass.** Wall linings can be bonded directly to the appliance, but avoid blocking air inlets or outlets.

Note: Some installation scenarios can expose materials to higher levels of heat than expected or allowable. Designers, owners, or Installers must choose materials that are suitable for use. Consult the *Escea website* for finish details.

FIREPLACE CHASE

The fireplace chase is a structure enclosing the gas fireplace and vent system, using wood, steel framing, or panels. In colder regions, it's advisable to enclose the vent within the chase. Check local regulations. Fire-stops are required for safety when the vent system passes through an interior, exterior wall or a ceiling. Requirements will vary with each geographic location and you should check local regulations.

The fireplace can be installed on the floor or an elevated structure. In all cases, use a solid, continuous surface like concrete, plywood, or compressed cement sheet. Avoid installing directly on carpet, rugs, or heat-sensitive floor finishes.

Note: *The fireplace chase detailed above, is 136" wide with 23" of framework on each side, allowing space for the vent and duct system, and symmetry.*

TV AND MANTEL CLEARANCE

You can mount a TV or other electrical appliances above the fireplace, either surface-mounted or recessed into the chase. Ensure the TV's base is at least 8" above the top of the glass viewing area. For a combustible mantel, install it a minimum of 8" above the fireplace. The mantel's clearance depends on its depth, with greater depth requiring higher clearance. Consult the relevant *Escea Install Manual* for details.

For Installation methods not covered in this document contact: aa@escea.com

Installation Manual and CAD files are available from the Escea website - scan the QR code

