



Order No. **X-136809**  
Model No. **OLF86-AM**

Notes:

## Section 10309 - Manufactured Electric Fireplaces

### PART 1 GENERAL

#### 1.1 SECTION INCLUDES

- A. Manufactured electric fireplaces.
- B. Accessories

#### 1.2 RELATED SECTIONS

- A. Section 06100 - Rough Carpentry: Wood framed rough opening and enclosure.

#### 1.3 REFERENCES

- A. UL - 2021
- B. CSA - C22.2 No. 46

#### 1.4 SUBMITTALS

- A. Submit under provisions of Section 01300.
- B. Product Data: Manufacturer's data sheets on each product to be used, including:
  - 1. Preparation instructions and recommendations.
  - 2. Storage and handling requirements and recommendations.
  - 3. Installation methods.
- C. Manufacturer's Certificates: Certify products meet or exceed specified requirements.
- D. Manufacturer's warranty.

#### 1.5 DELIVERY, STORAGE, AND HANDLING

- A. Store products in manufacturer's unopened packaging until ready for installation.
- B. Protect materials from exposure to moisture. Do not deliver until after wet work is complete and dry.

#### 1.6 WARRANTY

- A. Provide the manufacturer's 2-year limited warranty on electrical components.

### PART 2 PRODUCTS

#### 2.1 ACCEPTABLE MANUFACTURERS

- A. Pre-fabricated Electric Fireplace:
  - 1. Base: Dimplex Electric Fireplace  
Glen Dimplex Americas  
1367 Industrial Road  
Cambridge ON N3H 4W3  
1-888-346-7539  
www.dimplex.com
  - 2. Substitutions not permitted
  - 3. Requests for substitutions will be considered in accordance with provisions of Section 01600.



Order No. X-136809  
Model No. OLF86-AM

Notes:

## Section 10309 - Manufactured Electric Fireplaces

### 2.2 ELECTRIC FIREPLACES

#### A. General:

1. Provide all components and accessories required for a complete, functional unit.
2. cULus listed, file E71416

#### B. Pre-fabricated Electric Fireplace:

##### 1. Base Product:

- a) Dimplex Electric Fireplace
- b) Material Number: X-136809
- c) Model Number: OLF86-AM
- d) Regulatory model number: 6911540300

##### 2. Description: Optimyst 86" Linear electric fireplace

##### 3. Dimensions:

- a) Width: 87-1/2" / 222.2 cm
- b) Height: 31-1/2" / 80.0 cm
- c) Depth: 11-7/8" / 30.0 cm

##### 4. Framing Dimensions:

- a) Width: 88" / 223.5 cm
- b) Height: 31-3/4" / 80.6 cm
- c) Depth: 12" / 30.5 cm

##### 5. Electrical:

- a) Volts: 120 V, 240 V
- b) Watts: 1020 W (see note), 2400 W
- c) Amps: 8.5, 10

**Note:** When connected to 120 V, there will be no heat output, but heat functions will be active on the controls with only fans operating.

##### 6. Venting: Non-venting

##### 7. Air intakes: Minimum 160 in<sup>2</sup>

**CAUTION:** Failure to include a fresh air inlet will result in poor flame performance and damage to the fireplace. A fresh air inlet is required. The air inlet must allow for the air path to reach the underside of the unit. This will have to be accounted for in the framing and drywall installation. See the table below for air inlet requirements for each model. If the air inlet is concealed using a grille, the covered area must be compensated for by having a larger opening.

##### 8. Operation: Flame only, Flame and heat

##### 9. Heating: Fan-forced heater

##### 10. Standard features:

- a) Patented multi-colored 3D flame effect produced by LED lights and fine mist
- b) Optional plumbing connection for continuous water supply
- c) Overflow sensor to automatically shut off water supply to prevent leaks
- d) Adjustable flame and volume control



Order No. **X-136809**  
Model No. **OLF86-AM**

Notes:

## Section 10309 - Manufactured Electric Fireplaces

- e) Safe, cool-touch surfaces, ideal for residential and commercial applications
  - f) Proportional fan-forced heater with various modes including Eco, Boost, and fan
11. Control options:
- a) Flame Connect mobile app
  - b) Multi-functional remote
  - c) Built-in hidden touch controls
  - d) Built-in power switch (behind glass)
12. Optional Accessories:
- a) Plumb kit for continuous water supply – CDFIPLUMB-KIT (for use with ¼ inch copper piping)
  - b) Plug kit – OLFPLUG

### PART 3 EXECUTION

#### 3.1 INSPECTION

- A. Do not begin installation until substrates have been properly prepared.
- B. If substrate preparation is the responsibility of another installer, notify Architect of unsatisfactory preparation before proceeding.
- C. Verify proper power supply and fuel source are available.

#### 3.2 PREPARATION

- A. Clean surfaces thoroughly prior to installation.
- B. Prepare surfaces using the methods recommended by the manufacturer for achieving the best result for the substrate under the project conditions.

#### 3.3 INSTALLATION

- A. Install in accordance with manufacturer's instructions and requirements of authorities having jurisdiction.
- B. Use manufacturer's guidelines for minimum clearances to combustibles, walls, and finishes.
- C. Anchor all components firmly in position for long life under hard use.
- D. Upon completion of installation, visually inspect all exposed surfaces. Touch up scratches and abrasions with touch up paint recommended by the manufacturer; make imperfections invisible to the unaided eye from a distance of 5 feet (1.5 m).
- E. To use the mobile app, install where a WiFi connection is available.
- F. Minimum 160 in<sup>2</sup> inlet is required. If the air inlet is concealed using a grille, the covered area must be compensated for by having a larger opening.
- G. Ensure that all plumbing connections meet local plumbing code requirements. Ensure that the location of the plumbing connection allows for easy access to allow for shutoff during scheduled maintenance.

#### 3.4 PROTECTION

- A. Protect installed products until completion of project.
- B. Touch-up, repair or replace damaged products before Substantial Completion.

**END OF SECTION**



Order No. **X-136809**  
 Model No. **OLF86-AM**

Notes:

## Product Dimensions:

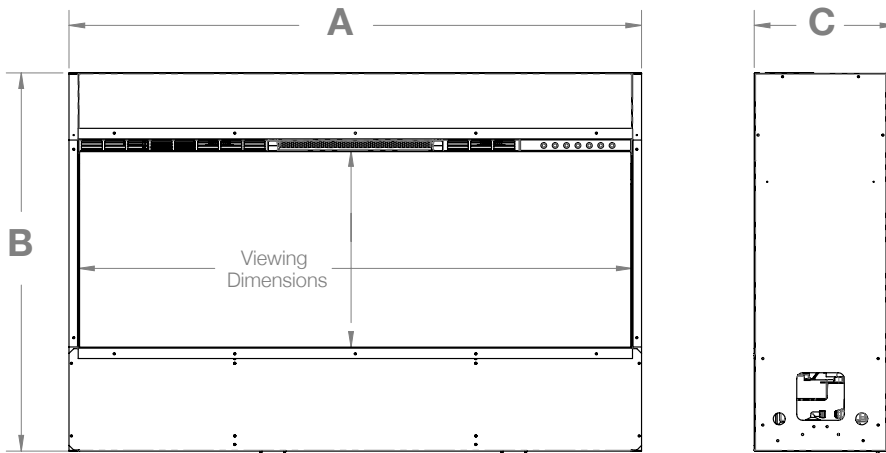

Product	A WIDTH (in/cm)	B HEIGHT (in/cm)	C DEPTH (in/cm)	VIEWING DIMENSION - WxH (in/cm)
OLF86-AM - 86" Linear	87-1/2 (222.2)	31-1/2 (80.0)	11-7/8 (30.0)	84-1/4 x 14-3/8 (213.8 x 36.3)

## Fresh Air Inlets

**CAUTION:** Failure to include a fresh air inlet will result in poor flame performance and damage to the fireplace.

A fresh air inlet is required. The air inlet must allow for the air path to reach the underside of the unit. This will have to be accounted for in the framing and drywall installation. See the table below for air inlet requirements for each model.

If the air inlet is concealed using a grille, the covered area must be compensated for by having a larger opening.

Model	Air inlet area required	
OLF86-AM	160 in <sup>2</sup>	1032 cm <sup>2</sup>

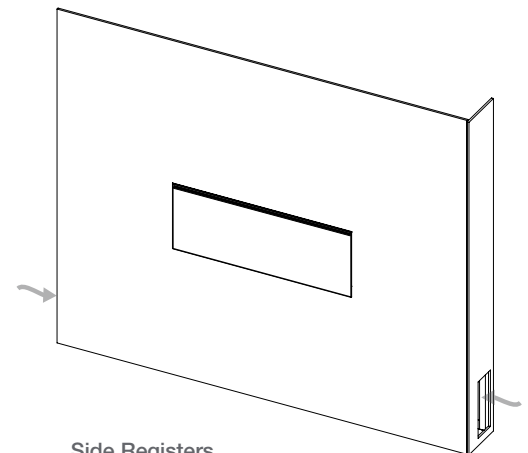
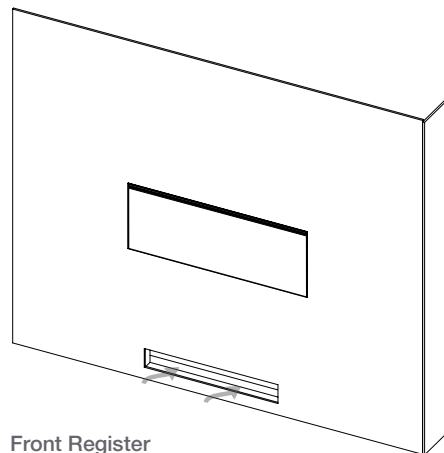
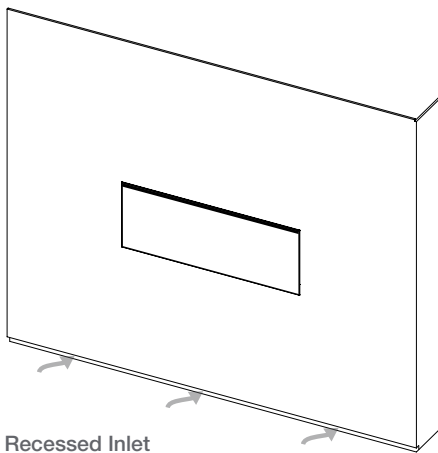

\*For best results in this configuration include an opening on each side of the fireplace



Order No. **X-136809**  
 Model No. **OLF86-AM**

Notes:

## Framing

Prepare a wall with a framed opening, following the dimensions in the table below. Openings beneath the unit are required in order to allow for airflow to reach the underside of the unit.

Model	Framing Dimensions			Drywall Opening	
	Width (minimum) A	Height B	Depth (minimum) C	Width D*	Height E*
OLF86-AM	88" (223.5 cm)	31-3/4" (80.6 cm)	12" (30.5 cm)	86-3/16" (219.0 cm)	17-1/2" (44.5 cm)

\* Allows for a 2 mm clearance all around

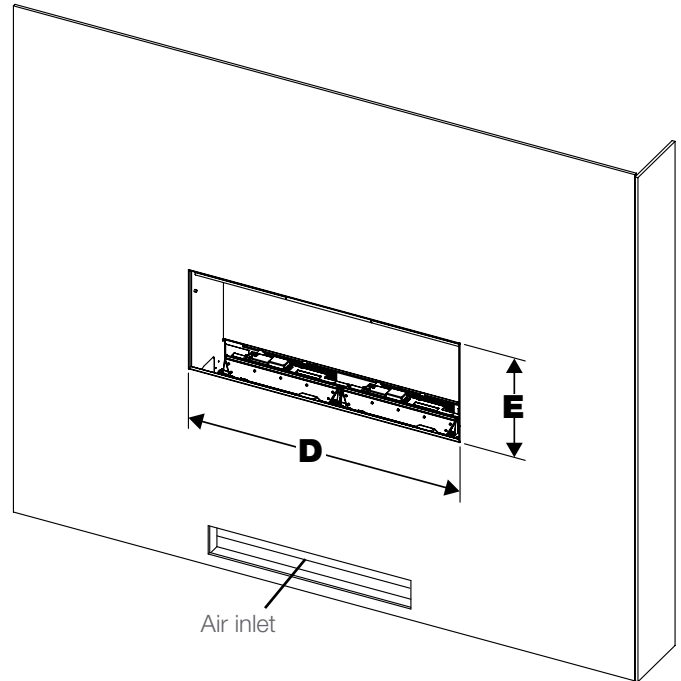
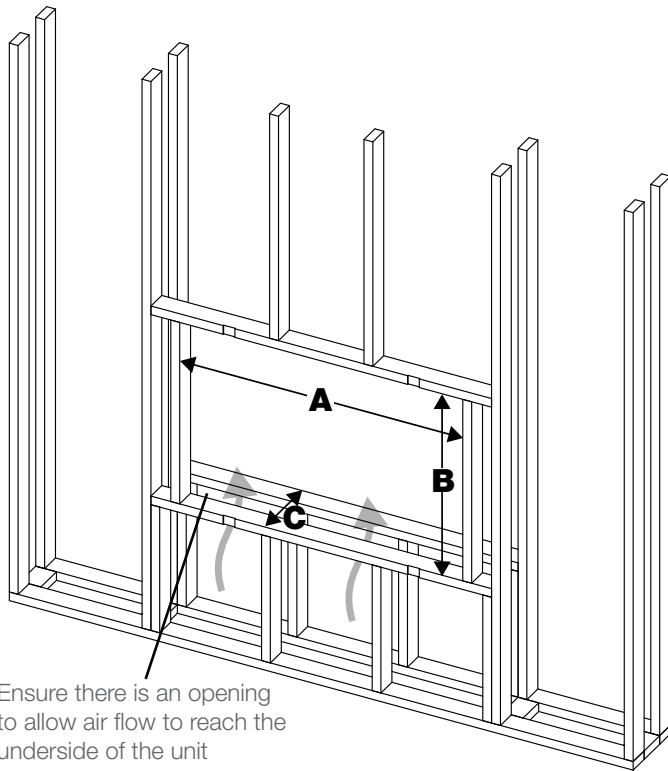

## Placement

**! NOTE:** For optimized viewing angle of the flame, it is recommended that the bottom of the unit be mounted between 5" (13 cm) and 50" (127 cm) from the ground.

### Installation in a Bathroom

If this unit is installed in a bathroom, it must be protected by a GFCI receptacle or circuit. If a receptacle is used, it must be readily accessible.

This electrical appliance is NOT watertight. To prevent electric shock, it must be installed as to prevent water from entering unit, or installed away from showers, tubs, etc. Never locate fireplace where it may fall into a bathtub or other water container.

### Installation Recommendations for Overhanging Objects

For overhanging temperature-sensitive objects, such as a television, a mantel, or artwork, always follow the recommendations provided by its manufacturer for installation over a heater.