



# TOUCH SCREEN STANDARD THERMOSTAT (TSST) OPERATING INSTRUCTIONS

This remote control transmitter provides a multifunctional, reliable and user-friendly remote control for the fireplace system. The transmitter can manually or thermostatically turn the system on and off. Always check the appliance home owner's manual for additional information, or warnings regarding accessory installation before using this remote control system.

Carefully inspect the contents for shipping damage. If any parts are missing or damaged, immediately contact the dealer from whom you purchased the kit or Ambient Technologies Technical Support at 1 800 398 6195. Do not attempt to install any part of the kit unless all parts are in good condition. Please keep this booklet for future reference.

## CONTENTS OF KIT

Description	Qty
Transmitter	1
Mounting Base	1
Battery Alkaline AAA	4
#6 <sup>3</sup> / <sub>4</sub> " Screws, Zinc	2
Receiver (Assembly) consists of:	1
Receiver Box	
Slide Button-Black (On/RS/Off)	
Battery Alkaline AA (for receiver)	4
Wall Cover Plate - Black	1
Wall Cover Plate - White	1
Slide Button - White (On/RS/Off)	1
Battery Door - White	1
Plug-in Wiring Assembly - 22"	1
Velcro (Loop and Hook)	1
Installation Instructions	1
#6 3/4" Screws, Zinc (for Wall Cover Plate)	2
#8 Screws (for fireplace system control covers)	2

## FEATURES

- Large LCD display
- Touch Screen Panel
- Thermostatic Control Mode
- Timer Mode
- Sleep Mode to Save Battery
- Slide Function for Fast Operation
- Low battery Indication on Transmitter
- Child Proof Lock-out
- LCD Backlight
- On-screen Security Codes Setup on Transmitter
- 16 Security Codes (DIP Switches) on Receiver
- Optional 6 Hour Shut Down on Receiver
- Quick Disconnect Wiring Assembly

**WARNING**  
**Important Safety Information**

- This remote control system should only be used as described in this manual. Any other use is not recommended and will void the warranty.
- Read this manual thoroughly prior to installing, programming or operating any remote control.
- This remote control system is designed for use with a millivolt gas valve system. Do not use this remote control system on applications with voltages above 30 Volts AC.
- This remote control system requires **Four (4)** “AAA” alkaline batteries to power the transmitter and Four (4) “AA” batteries to power the receiver. Wiring must conform to appliance requirement and building codes/ordinances as required by local and national code authorities having jurisdiction.
- Do not short (or jumper) across the gas valve terminals to test the remote control installation. This could damage the unit and void the warranty.
- This remote control system should only be used as described in this manual. Any other use is not recommended and will void the warranty.

**NOTE**

**Due to the sensitive temperature monitoring components in the transmitter, it is necessary to allow the transmitter to stabilize to room temperature before accurate room temperatures are displayed. If the transmitter is activated from a severe cold condition, allow 15 minutes for accurate temperature readings to appear on the LCD display.**

**WARNING**

**Turn appliance OFF and allow to cool before installing or servicing. The remote operator must be installed exactly as outlined in these instructions. Read all instructions completely before attempting installation. Follow instructions carefully during installation. Any modification of components will void the warranty and may cause a fire hazard.**

**WARNING**

**Turn appliance OFF (at the appliance or remote receiver) if you are away from your house for an extended period of time. Never leave anything on top of the surface of the transmitter.**

## INSTALLATIONS

### Receiver

The remote receiver may be wall mounted or installed in the appliance per the appliance homeowner's manual. **Refer to the Homeowner's Manual for special installation instructions.** If wall mounted, the remote receiver must be installed in a junction box with cover plate provided. Failure to follow the installation instructions found in the appropriate Homeowner's Manual will void the warranty and may cause a fire hazard.

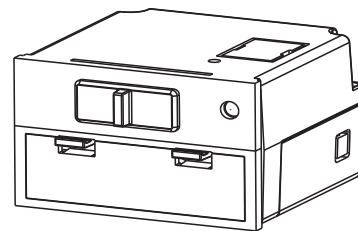

### Installing Batteries

The remote receiver uses four (4) "AA" batteries. To install batteries,

1. Open the battery door by pressing the two tabs located on the door.
2. Install the batteries as indicated in the receiver cover.
3. Close the battery door until the door tab snaps in place.
4. To install the receiver into a wall junction box, snap wall cover plate to the receiver and install the receiver with the screws provided to the junction box.
5. The batteries should be replaced at least once every 6 months or when the battery indicator flashes.

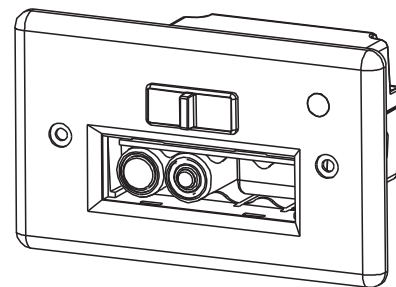

### Connecting the Receiver to your appliance

This system comes with a 22 inch wire assembly. Insert the white terminal to the back of the receiver. The terminal wire block can only be installed one way. Do not force the terminal plug onto the receiver.

Connect the wiring terminal two (2) 1/4" female spade terminals to the appliance. Refer to the appropriate Homeowner's Manual for proper wiring connections to the appliance. Your appliance may have other options to connect wiring from receiver. Connect to the two (2) 1/4" female spade wiring terminals. Wire can be no longer than 20 feet.

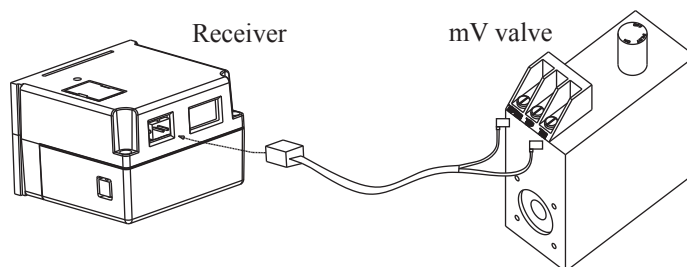

### Optional 6 hour Shutdown

1. The receiver comes preset from the factory with a 6 hour shutdown from its last ON operation. This is done to prevent the appliance from continuing to run if unattended.
2. You may disable this feature if you wish. To disable, change the receiver privacy (DIP) switch #1 **ONLY** to the OFF position. Make sure the transmitter privacy (DIP) switches are set the same to the receiver. Follow the instructions on how to set the privacy (DIP) switch setting.
3. **By disabling this feature, your appliance may continue to run unattended.**

**WARNING**

Make sure that the wires do not contact the appliances any place other than at the terminals. Exposure to temperatures higher than 105° C (250° F) may cause the receiver to malfunction or fire hazard.

## Transmitter

### ■ Function Areas of the LCD Display

The figure on the right shows the display of the TSST LCD.

#### Information Bar

The information bar shows the room temperature, the “sending signal” radio icon, the low battery indication icon, the child-proof icon, and the flame icon. This area doesn’t have touch buttons.

- The room temperature will always be shown after power-up. It displays the room temperature from 40 °F to 99 °F. “Lo” and “HI” will be displayed when the room temperature is lower than 40°F or higher than 99°F, respectively.
- The radio icon will be shown when the transmitter is sending a signal.
- The low battery indication icon will be shown when the battery voltage is low.
- The child-proof icon will be shown when the child-proof mode is activated.
- The flame icon indicates the current fireplace status – On or Off.

#### Touch Area

The touch area contains all touch buttons to control the transmitter. It consists of two categories: menus and adjustment arrows. The blue LED backlight lights up for 8 seconds when any of the touch buttons is pressed.

- The menu contains the TIMER and THERMO buttons.
- The adjustment arrows include ON/up and OFF/down. Their default function is to turn on/off the flame. When a button from the menu is pressed, the ON/up and OFF/down buttons will temporarily become adjustment controls for the selected item. When the adjustment is done, the ON/up and OFF/down buttons go back to flame controller again.

#### Logo Bar

The Logo Bar contains the brand logo: Ambient Technologies.

### ■ Initialization and Setting up

#### Installing Batteries:

The remote transmitter has two battery compartments, one on each end of the transmitter. **Always change all four (4) batteries at the same time.**

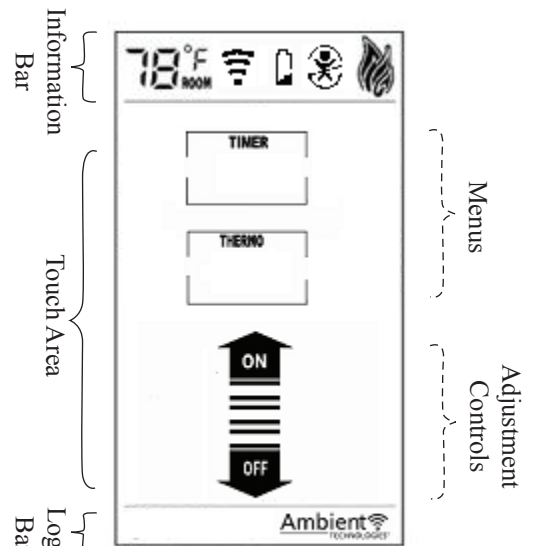

Function Areas of the LCD Display

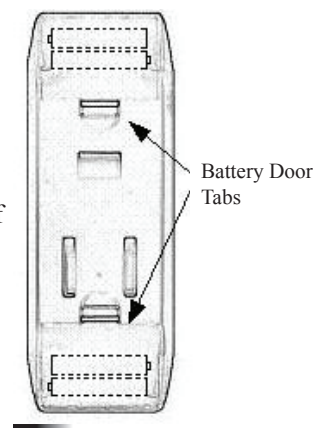

To install batteries,

1. Press down the battery door tab and pull out to remove the battery door.
2. Install the batteries as indicated inside the battery compartments.
3. Close the battery door by snapping in place.
4. When all **four** batteries are installed, the transmitter will initialize for 5 seconds and then is ready for use.
5. The batteries should be replaced every 12 months or when the low battery icon indicator is displayed.

### Changing Temperature Unit

When batteries are installed in the transmitter,

1. all available icons on the LCD will be turned on then be cleared.
2. the LCD will display temperature unit: °F. Use ON Δ to toggle the units between °F and °C within the first 5 seconds.
3. the transmitter enters Manual Mode
4. the LCD displays room temperature with the chosen unit.

### Setting Privacy Code on Transmitter and Receiver:

The remote transmitter privacy code and receiver privacy (DIP) switches are preset in factory. In the event of activation or interference from other nearby transmissions, change the code using the following procedures:

1. Press the ON/arrow button and the TIMER button at the same time to enter privacy code setup mode.
2. The setup display is shown in the figure. The four digits on the top stand for the privacy code (as the actual DIP switches on Ambient's previous remotes). The default values of the four digits will be all "1" (ON).
3. The first digit will be flashing upon entering the setup mode. Push the ON button to toggle its value between "0" (OFF) and "1"(ON), and push the OFF button to jump to the next digit. The next digit will then start flashing and the first one stops flashing. Set up the four digits to your choice.
4. After setting up all the four digits, push OFF key to finish the process and return to the previous mode.

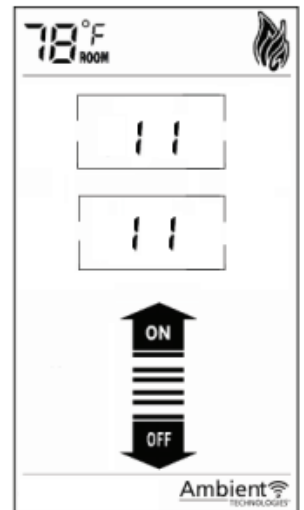

The DIP switches on the receiver need to be changed accordingly after changing the code on the transmitter:

1. Slide the code switches on the receiver up or down to match the four ON or OFF positions on the transmitter. Switches #1, #2, #3 and #4 are preset to "ON" for receiver.
2. To check, touch either the On or Off button on the transmitter and the receiver indicator light will blink. If not repeat step 1.
3. The system is now ready to operate. See optional 6 hour shutdown on receiver section.

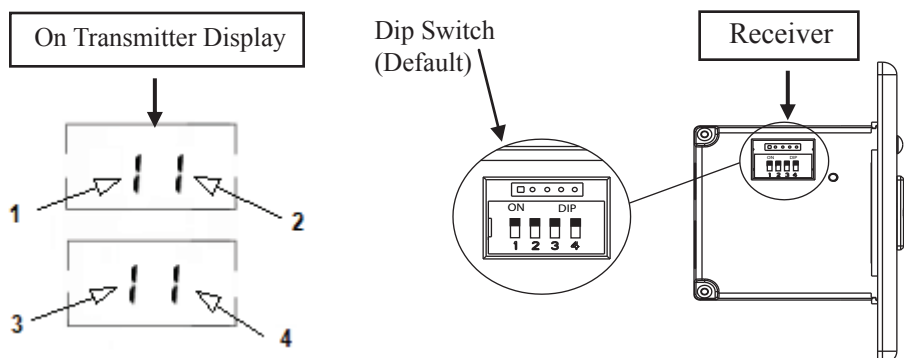

**WARNING**

**Do not use two (2) or more remote control systems in the same area with the same privacy code setting, as they will communicate with each other. This may cause the appliances to malfunction.**

Resetting the transmitter:

If the transmitter is not working properly, reinstall the batteries to reset the transmitter.

1. Pull out at least one of the batteries.
2. Press any key on the screen to discharge.
3. Wait for 10 seconds and then reinstall the batteries.

Pushing and holding any key for more than 10 seconds until the display refreshes will also reset the transmitter.

### ■ Functions and Operations

General:

The TSST Remote Control has two (2) operating modes: Manual and Thermostatic. The thermostat control can be set to temperature range between 45° F and 90° F. The fireplace can be turned on/off in either the manual and thermostatic mode.

The transmitter will operate the remote receiver from 1 foot to a maximum of 30 feet. The distance is reduced when batteries are low.

Manual Mode

In this mode, the TIMER button and the THERMO button will only display “TIMER” and “THERMO”, respectively without showing the time and the SET temperature. Pressing the ON/up and OFF/down buttons will turn on and turn off the fireplace if none of the menu buttons (TIMER, THERMO) are pressed and flashing.

1. Press the ON/up button to turn on the fireplace. The flame icon on the LCD displays High.
2. Press the OFF/down button to turn off the fireplace. The flame icon disappears.
3. Sliding up and down on the arrow buttons can also turn on or turn off the fireplace.

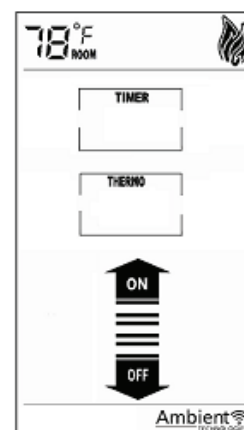
Timer Mode

Press the TIMER button to enter timer mode. The fireplace will stay on for a period of time as specified by the timer and then be shut off by the transmitter when the timer counts down to zero.

1. When the TIMER button is pressed, the Set Time appears in the frame of the button and flashes.
2. Use ON and OFF arrows to increase or decrease the Set Time in 15 min increment, between 0:00 to 6:00. Slide up and down on the arrow buttons will increase or decrease the Set Time in 1 hour increment.
3. Push the TIMER button again to confirm the Set Time, the transmitter sends an ON signal to turn on the fireplace.

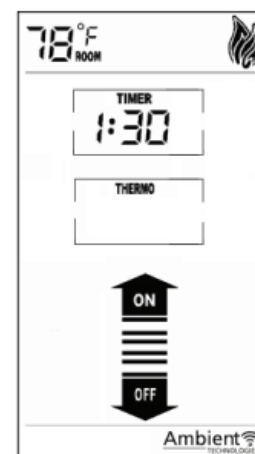

4. The flashing stops and the ON/up and OFF/down buttons become flame controller again.
5. The TIMER button can be used when the transmitter is in Manual Mode or in Thermostat Mode. In both modes, the fireplace will be shut down completely when the timer counts down to zero.
6. To exit Timer Mode,
  - a. Push and hold the TIMER button for 3 seconds Or
  - b. Use the OFF/down buttons to decrease the Set Time to zero.

### Thermostat Mode (Auto Mode)

Press the THERMO button to set the transmitter in thermostat mode. The transmitter will automatically turn on the fireplace when the room temperature is below the set temperature and turn off the appliance when the room temperature is above the set temperature within one degree.

1. When the THERMO button is pressed, the Set temperature appears in the frame of the button and flashes.
2. Use ON and OFF to increase or decrease the Set temperature in 1 degree increment, between 45 degrees and 90 degrees. Slide up and down on the arrow buttons will increase or decrease the Set Temperature in 10 degrees increment.
3. Press the THERMO button again to confirm the Set Temperature. The transmitter will send out an On signal or an Off signal depending on the relationship between the Set temperature and the Room temperature.
4. The flashing stops and the ON and OFF buttons become flame controller again.
5. To exit Thermostat Mode, push and hold the THERMO buttons for 3 seconds or press the OFF button.

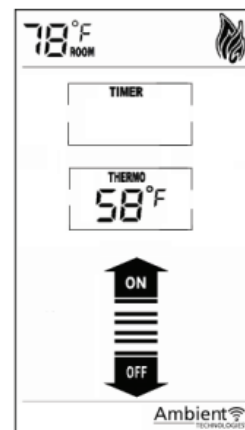

### Setting up Blank Screen or Constant Display in Idle

There is an option to set up how the LCD displays and functions when the transmitter is in idle. There are two choices:

1. A) Mode. When the transmitter is in idle, the icons in the “touch area” (timer, thermostat, ON/OFF) will disappear, as shown in the figure on the left. When any of the touch buttons is pressed, those icons will appear and ready to operate (default).
2. B) Mode. The transmitter always displays all available icons showing current status of timer and thermostat as shown in the figure on the right.

Press TIMER and THERMO buttons at the same time for 3 seconds to toggle between A) and B).

1. When the current setting is B), pressing TIMER button and THERMO button at the same time for 3 seconds will switch to A) Mode. The touch area icons will disappear.
2. When the current setting is A), touch any place in the touch area to bring up the icons then press TIMER button and THERMO button at the same time for 3 seconds. The backlight will flash once to indicate that the setting has changed to B).



## ■ Safety Features

### 1. Low Battery Detection

When low battery condition occurs, the transmitter will turn off the fireplace.

- A) Battery voltage is checked every one minute. When the battery voltage is low, the LCD displays a low battery icon which will exist in all modes.
- B) The transmitter will not operate with low battery voltage. Change the batteries before the batteries become too weak for normal operations.



2. Power On Initialization

After the power-on initialization, the transmitter sends a signal to turn off the fireplace.

3. Thermal Shutdown

When the ambient temperature is more than 99°F, the transmitter will turn off the fireplace.

A) The LCD will display “HI”.

B) The Transmitter will not function until the room temperature has dropped below 99 degree Fahrenheit.



4. Low Temperature Condition

When the ambient temperature is less than 40 degrees Fahrenheit, the LCD will display “LO”, and NO SIGNAL will be sent to turn on the appliance.

All functions still remain the same for both Manual Mode and Thermostat Mode



5. Child-proof Protection

The child-proof icon will be shown when the child-proof mode is activated by pressing the ON button and the OFF button at the same time for three seconds.

A) Enter childproof mode by pressing and holding both the ON button and the OFF button simultaneously for 3 seconds. The Childproof indicator will be shown on the LCD.

B) Deactivate childproof mode by pressing and holding the ON button and the OFF button simultaneously for 3 seconds again. The Childproof indicator disappears on the LCD.

C) The transmitter cannot be operated in childproof mode.



TROUBLESHOOTING

Symptom	Causes	Action
1. Battery icon on LCD on transmitter	1. Low Battery	1. Replace batteries. Change batteries every 6 months.
2. LCD display is blank		2. Check battery installation or replace batteries.
3. LCD display shows “funny” display		3. Reset the transmitter (see “Resetting the Transmitter” section).
4. Appliance does not come on	2. The transmitter did not match with the receiver	1. Make sure the transmitter has learned to the receiver.
	3. Transmitter measures temperature exceeding 99 degrees Fahrenheit and shows “HI” on LCD	1. Move transmitter to a cooler place and wait until temperature drops below 99 degrees.
	4. Distance between the transmitter and receiver is more than 30 feet	1. Make sure the opening distance is less than 30 feet.
	5. Receiver not turned on.	1. Set receiver to R/S.
	6. Wiring loose or no correct.	1. Check wire connection (TH/TP/TH).



**WARNING:** Changes or modifications to this unit not expressly approved by the party responsible for compliance could void the user's authority to operate the equipment.

**NOTE:** This equipment has been tested and found to comply with the limits for a Class B digital device, pursuant to Part 15 of the FCC Rules. These limits are designed to provide reasonable protection against harmful interference in a residential installation. This equipment generates uses and can radiate radio frequency energy and, if not installed and used in accordance with instructions, may cause harmful interference to radio communications. However, there is no guarantee that interference will not occur in a particular installation. If this equipment does cause harmful interference to radio or television reception, which can be determined by turning the equipment off and on, the user is encouraged to try to correct the interference by one or more of the following measures:

- Reorient or relocate the receiving antenna.
- Increase the separation between the equipment and receiver.
- Connect the equipment into an outlet on a circuit different from that to which the receiver is connected.
- Consult the dealer or an experienced radio/TV technician for help.

## **WARRANTY**

This warranty gives you specific legal rights and you may also have other rights that vary from state to state or province to province. Answers to any questions regarding our limited warranty may be obtained by writing our corporate offices.

Ambient Technologies warrants each new Ambient Technologies remote control against any defects that are due to faulty material or workmanship to the original owner, for a period of five years after the original date of purchase. This warranty and our liability does not apply to batteries, nor does it include damage to merchandise or the remote control resulting from accident, alteration, neglect, misuse, improper installation or any other failure to follow Ambient Technologies installation and operating instructions.

After contacting Ambient Technologies Tech Service to receive a return authorization number, we agree to repair or replace at our option any Ambient Technologies remote control under warranty. Provided it is returned postage prepaid to our warranty facility in a padded carton within the warranty period, with proof of the original date of purchase and a brief description of the malfunction. This limited warranty does not include the cost of removal or re-installation.

Ambient Technologies  
149 Cleveland Drive  
Paris KY 40361

FOR TECHNICAL SUPPORT  
CALL 800-398-6195