



TOFINO i40S

40,000 BTU High – P.4.1 71.3%



UNIT DIMENSIONS

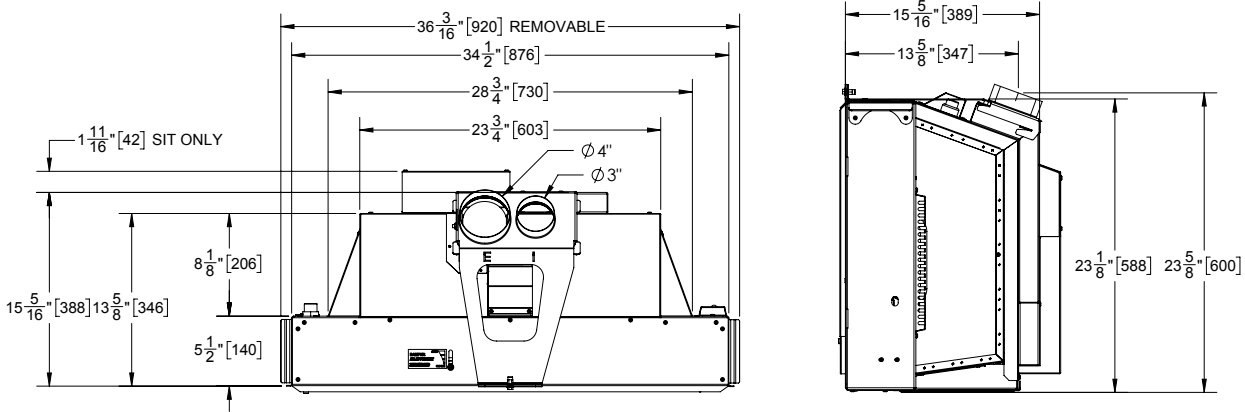

BACKING PLATE

Standard	28"	42"
Oversize	31"	44"

MINIMUM FIREPLACE OPENING

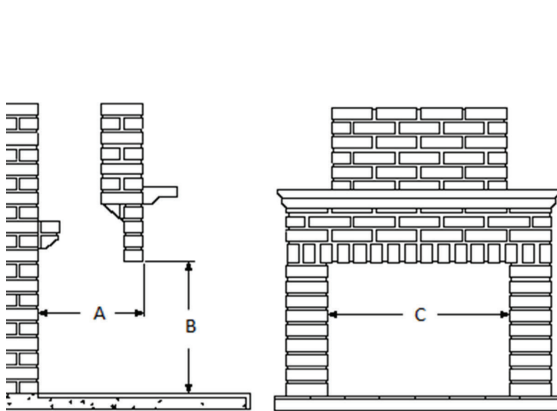

A	17 7/8"
B	24 5/8"
C (w/handles)	35" (36 1/2")

CLEARANCES TO COMBUSTIBLES

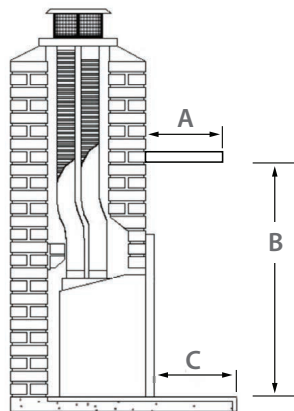

A	14"
B	30"
C	0"
Objects in front of unit	36"
Horizontal clearance to comb.	20" (from centre of unit)