



Landscape Fullview Series

**LFV2-40/15-SH • LFV2-60/15-SH • LFV2-80/15-SH
LFV2-100/15-SH • LFV2-120/15-SH**



INSTALLATION/SERVICE INSTRUCTIONS
FOR USE IN UNITED STATES AND CANADA



**LANDSCAPE FULLVIEW SERIES GENERATION 2
LFV2-40/15-SH • LFV2-60/15-SH • LFV2-80/15-SH
LFV2-100/15-SH • LFV2-120/15-SH
SAFETY INFORMATION AND OPERATIONS MANUAL**



Read these instructions completely before beginning installation. Failure to follow them could cause a heater malfunction resulting in serious injury and/or property damage.

WARNING: All electric heaters have hot and arcing or sparking parts inside. Do not use it in areas where gasoline, paint or flammable liquids are or are stored.

This fireplace meets the construction and safety standards of H.U.D. for application in manufactured homes when installed according to these instructions.

INSTALLER: Leave this manual with the appliance.
CONSUMER: Retain this manual for future reference.

USER INSTRUCTIONS

TABLE OF CONTENTS

Important Instructions	3	Operation	9
Power Data.....	4	Service Parts.....	10
Product Guide	4	Troubleshooting	12
Box Contents.....	5	Frequently Asked Questions	13
Locating Fireplace.....	5	Cleaning and Maintenance Instructions	14
Installation	5	Wiring Diagram	14

IMPORTANT INSTRUCTIONS

When using electrical heaters, basic precautions should always be followed to reduce the risk of fire, electric shock and injury to persons, including the following:

WARNING: Improper installation, adjustment, alteration, service or maintenance can cause injury or property damage. Refer to this manual. For assistance or additional information, consult a qualified installer.

CAUTION: Do not expose the heater to the elements (such as rain, etc).

Do not place clothing or other flammable material on or near firebox. Never place any objects on the fireplace.

Carefully supervise young children when they are in the room with fireplace.

Fireplace becomes very hot when running. Keep children and adults away from hot surfaces to avoid burns or clothing ignition. Fireplace will remain hot for a time after shutdown. Allow surfaces to cool before touching.



CAUTION: In order to avoid overheating, do not cover the heater.

1. Read all instructions before installing or using this heater.
2. This heater is hot when in use. To avoid burns, do not let bare skin touch hot surfaces. Keep combustible materials, such as furniture, pillows, bedding, papers, clothes, and curtains at least 3 feet (0.9m) from the front of the heater and keep them away from the sides and rear.
3. Extreme caution is necessary when any heater is used by or near children or disabled people and whenever the heater is left operating and unattended.
4. Do not operate any heater after it malfunctions, has been dropped, or damaged in any manner. Disconnect power at service panel and have heater inspected by an authorized technician or a reputable electrician before using.
5. Do not use outdoors.
6. To disconnect heater, turn controls to off and turn off power to heater circuit at main disconnect panel.
7. Do not insert or allow foreign objects to enter any ventilation or exhaust opening as this may cause an electric shock or fire, or damage the heater.
8. To prevent a possible fire, do not block air intakes or exhaust in any manner.
9. A heater has hot and arcing or sparking parts inside. Do not use it in areas where gasoline, paint or flammable vapors or liquids are used or stored.
10. Use this heater only as described in this manual. Any other use not recommended by the manufacturer may cause fire, electric shock or injury to persons.
11. This heater is not intended for use in bathrooms, laundry areas and similar indoor locations. Never locate heater where it may fall into a bathtub or other water container.
12. SAVE THESE INSTRUCTIONS

USER INSTRUCTIONS

POWER DATA

	Lfv2-40/15-SH	Lfv2-60/15-SH	Lfv2-80/15-SH	Lfv2-100/15-SH	Lfv2-120/15-SH
Volts/HZ Amps	AC 120V/60Hz 15 Amps	AC 120V/60Hz 15 Amps	AC 120V/60Hz 15 Amps	AC 120V/60Hz 15 Amps	AC 120V/60Hz 15 Amps
Heater	AC 120V/60Hz 750W/1500W	AC 120V/60Hz 750W/1500W	AC 120V/60Hz 750W/1500W	AC 120V/60Hz 750W/1500W	AC 120V/60Hz 750W/1500W
Lamps	LED 12V	LED 12V	LED 12V	LED 12V	LED 12V
Rotor motor	AC 120V/60Hz 4W CCW 15/18 r/ min	AC 120V/60Hz 4W CCW 15/18 r/ min	AC 120V/60Hz 4W CCW 15/18 r/ min	AC 120V/60Hz 4W CCW 15/18 r/ min	AC 120V/60Hz 4W CCW 15/18 r/ min
Shipping Size	58" x 26" x 14"	78" x 26" x 14"	98" x 26" x 14"	118" x 26" x 14"	138" x 26" x 14"

PRODUCT GUIDE

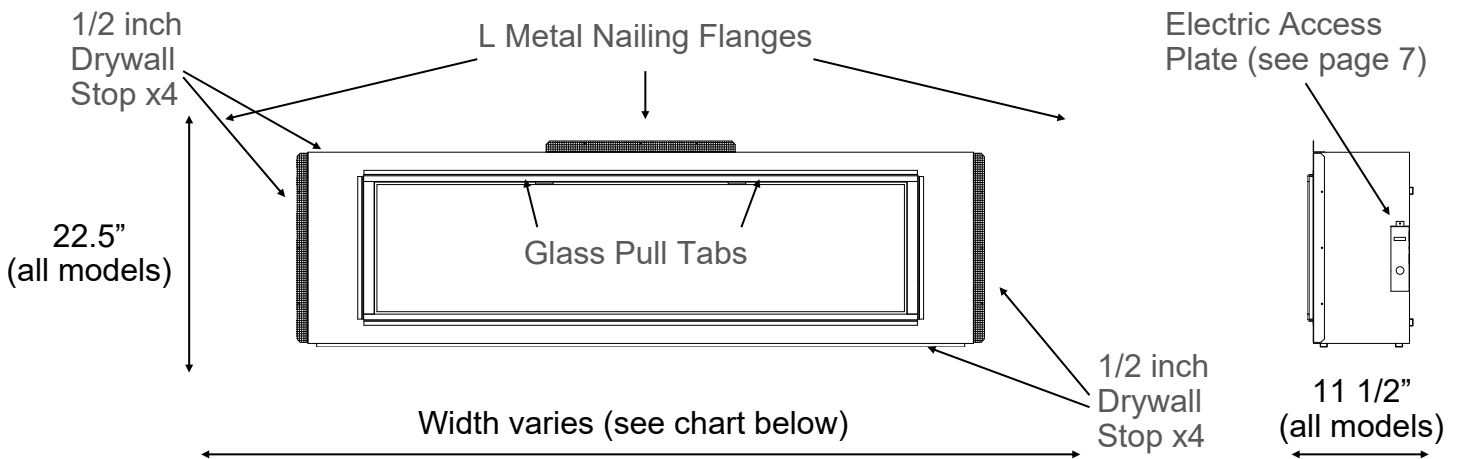

Model	Viewing Area	Firebox Dimensions	Framing Dimensions
Lfv2-40/15-SH	40" W x 15" H	54 3/4" W x 22 1/2" H x 11 1/2" D	55 3/4" W x 23" H x 12" D
Lfv2-60/15-SH	60" W x 15" H	74 3/4" W x 22 1/2" H x 11 1/2" D	75 3/4" W x 23" H x 12" D
Lfv2-80/15-SH	80" W x 15" H	94 3/4" W x 22 1/2" H x 11 1/2" D	95 3/4" W x 23" H x 12" D
Lfv2-100/15-SH	100" W x 15" H	114 3/4" W x 22 1/2" H x 11 1/2" D	115 3/4" W x 23" H x 12" D
Lfv2-120/15-SH	120" W x 15" H	134 3/4" W x 22 1/2" H x 11 1/2" D	135 3/4" W x 23" H x 12" D

INSTALLATION

BOX CONTENTS

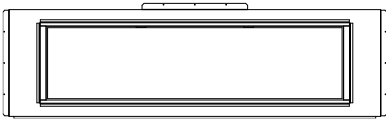

1 Fire Unit



L Metal Nail-
ing Flanges
(with screws)



1 Piece Trim
Deco Trim
Kit

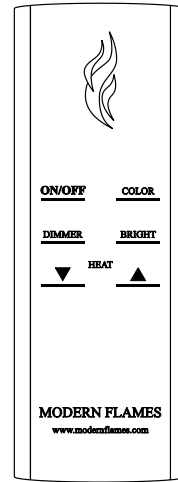

1 Remote

LOCATING FIREPLACE

CAUTION: Do not locate in a moist room such as a bathroom or laundry room.

CAUTION: Wear gloves and safety glasses for protection during installation and maintenance.

INSTALLATION

WARNING: If the information in these instructions is not followed exactly, a fire or explosion may result causing property damage, personal injury or death.

WARNING - RISK OF FIRE!

To prevent a possible fire, do not block air intake or exhaust in any manner. Do not use on soft surfaces where openings may become blocked.

WARNING - RISK OF FIRE!

Do not blow or place insulation against the firebox.

To reduce the risk of fire do not store or use gasoline or other flammable vapors in the vicinity of this or any other heater.

CAUTION: Keep combustible materials, such as furniture, pillows, bedding, papers, clothes and curtains at least 3 feet (0.9m) from the front of the heater and keep them away from the sides and rear.

Installing fireplace

Select a suitable location that is not susceptible to moisture and is a safe distance from drapes, furniture and high traffic areas. A qualified electrician should add a flexible 15 amp 120 volt circuit per local building codes. *Note: Follow all national and local electrical codes.*

INSTALLATION

Model	H	W	D
LFV2-40/15-SH	23"	55 3/4"	12"
LFV2-60/15-SH	23"	75 3/4"	12"
LFV2-80/15-SH	23"	95 3/4"	12"
LFV2-100/15-SH	23"	115 3/4"	12"
LFV2-120/15-SH	23"	135 3/4"	12"

1. Prepare the framed opening according to the chart above. Provide a flexible 15 amp 120 volt circuit for hard wire installation.
2. Install L Metal Nailing Flanges.

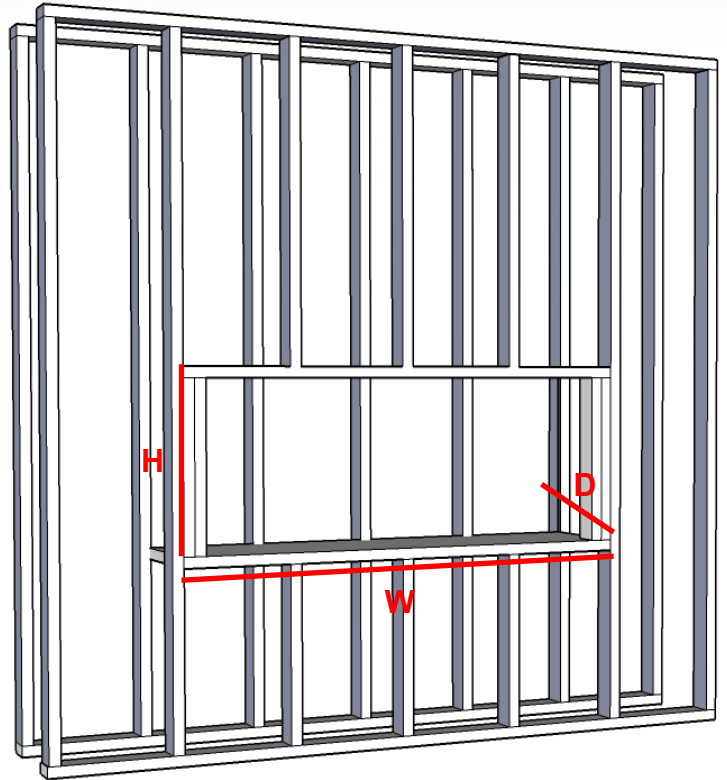

To be performed by a qualified electrician according to local building codes.

3. Connect hard wire to the terminal block according to the diagram below. Choose any connector type according to local building code.

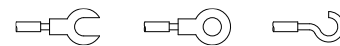
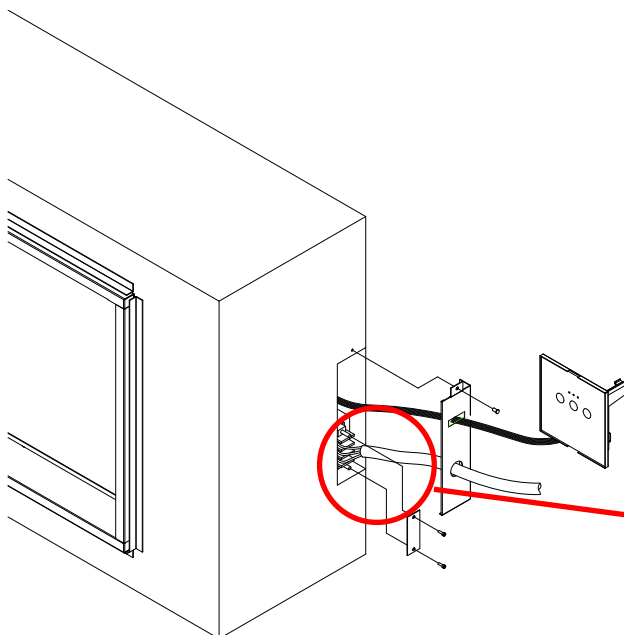

Terminal block

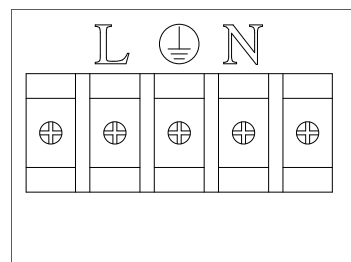

INSTALLATION

4. Install the fire unit in the framed opening with a minimum 1 ¼ drywall screws to secure the unit.

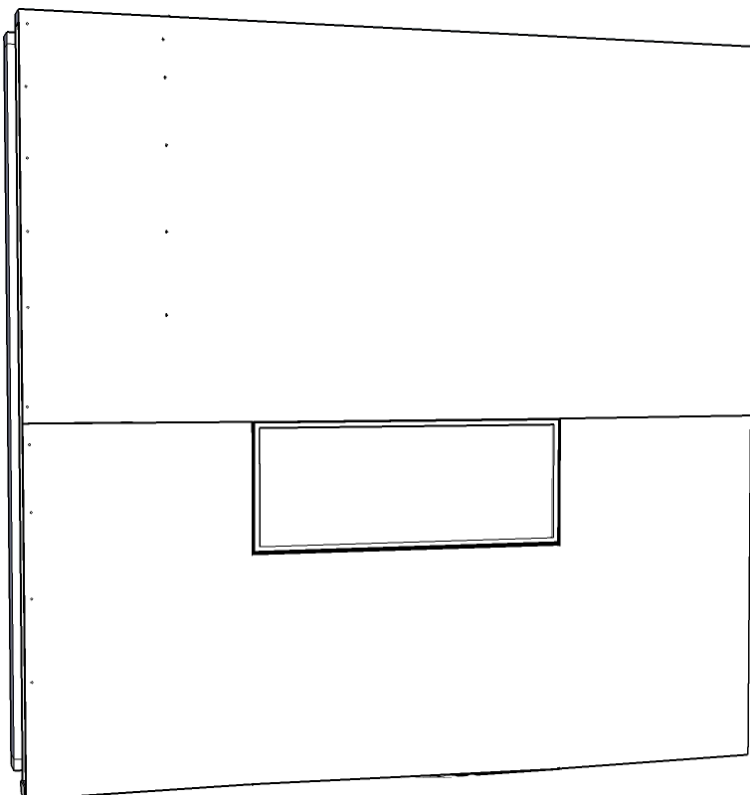
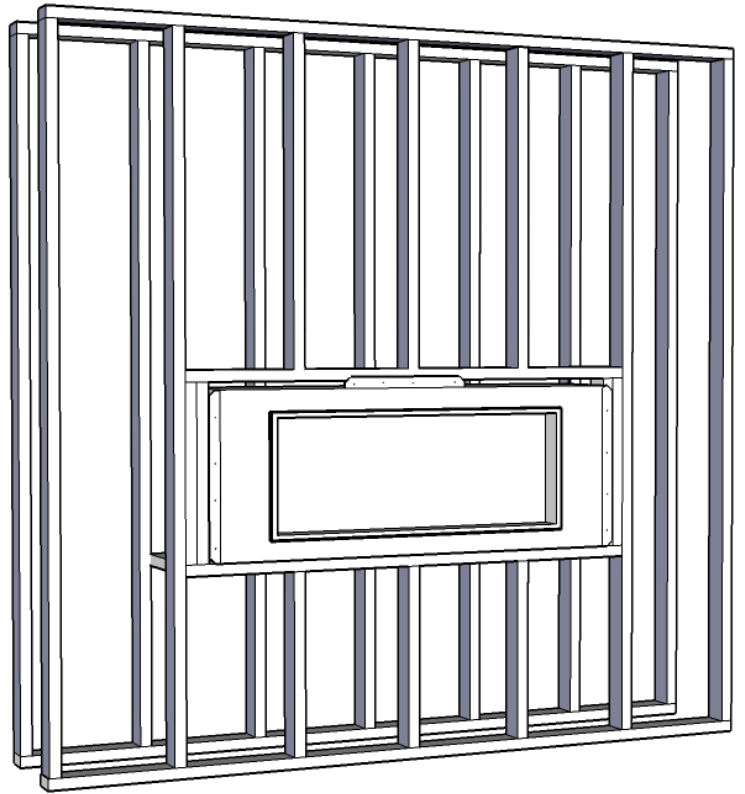

5. Mask the exposed fire unit during the drywall process. Install drywall to the drywall stops on the perimeter of the fire insert. For more information on the drywall stops see the Product Guide on page 4. Decorate as desired.
6. After installation, user may elect to use the L Metal Deco Trim. To install, use a small amount of construction adhesive and secure to the drywall face.

Installing remote touch control

1. Locate and remove the access door on the rear right side of the fire unit.
2. Locate the remote touch control directly inside the access panel. Pull the touch control through the access panel and replace the access door. Locate the touch control anywhere within cable length. **DO NOT INCREASE LENGTH OF WIRES CONNECTING TOUCH CONTROL TO UNIT.**
3. Remove glass face (attached with magnets) from touch assembly. Cut out drywall to match orange bracket. Turn the 2 screws visible in the face to secure the bracket to the wall. Replace the glass face.

If you decide not to install the touch control unit in the wall, IT IS IMPORTANT YOU LEAVE THIS WIRED TO THE UNIT. Leave it stored inside the compartment near the terminal block where you originally found it. This is important for severing the unit should this piece fails.

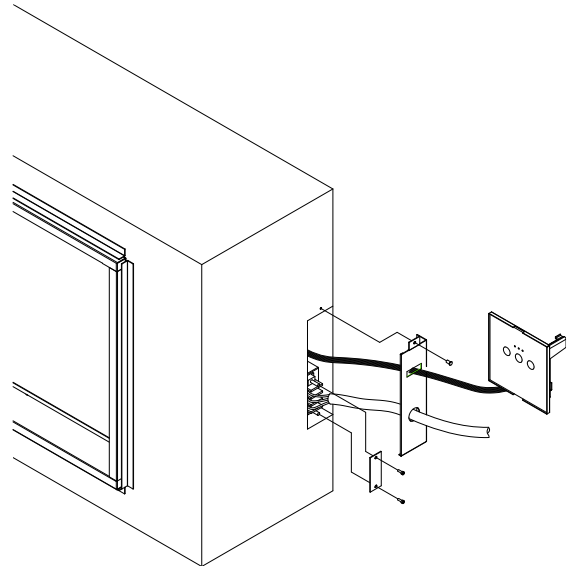

Touch control glass face

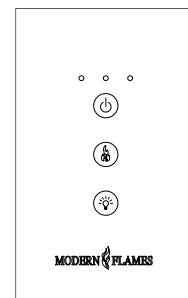

Installing a fire feature (Canyon Juniper Log set, Crystal Glass Coal set)

1. Remove the inner glass panel by first removing the 2 screws in the finger pull tabs (finger pull tabs are located on the top of the glass panel.) Tilt the glass face down about 45 degrees and remove the glass. Store the glass panel upright (not on it's face) in a safe place.

CAUTION: There are locator pins on the bottom of the glass panel. Lift gently to avoid damaging the pins and unit face.

Finger pull tabs

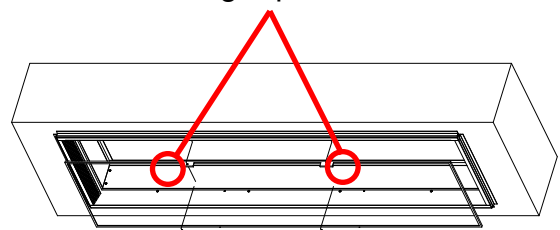

2. Follow the instructions included with the fire feature.

MAINTENANCE

OPERATION

The unit is hardwired and has no main switch. (Caution: If servicing this unit, turn off power at the main circuit breaker.) An optional tethered wall control switch is included, refer to installation instructions to relocate the tethered wall control switch to a wall location.

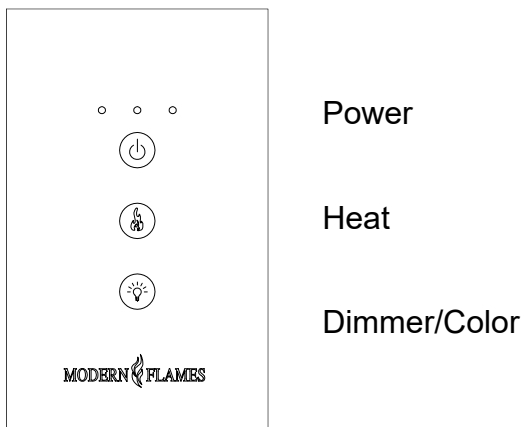

Power
Heat
Dimmer/Color

When all indicator lights are off, touching any button will only show the status. Once the indicator lights are on you can begin operation. Touch the Power button to turn the machine on. This will be indicated by 1 orange LED light. Touch the Power button again to turn off the machine. The Heat button can be pressed multiple times and will turn on low, high and off in that order. The Dimmer/Color button turns on high, medium, low and off in that order. Long-press the Dimmer/Color button to toggle the flame color from orange to blue.

Power indicator lights for wall switch as well as lower right corner of the main unit

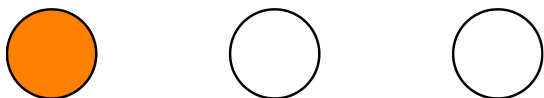

When the switch turns on, this orange pilot lamp turns on. It shows the fire is energized. This light will turn off in a few seconds if there are no commands received.



The status light above shows that the power is on and the heater is on low

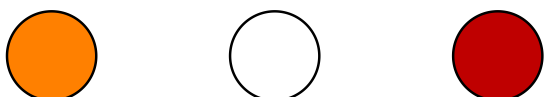



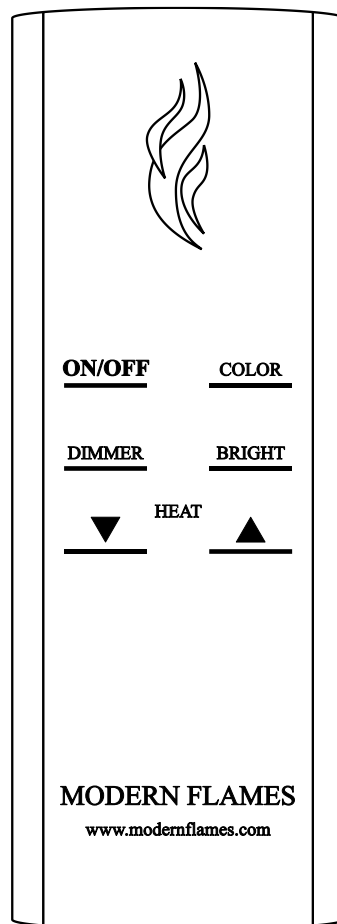

The status light above shows that the power is on and the heater is on high

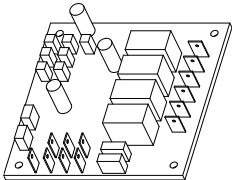
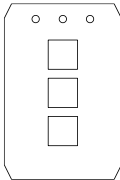
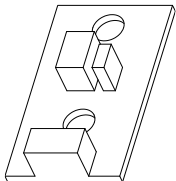
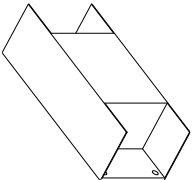
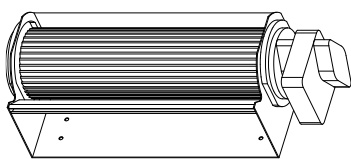
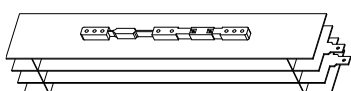
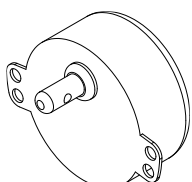

The On/Off button toggles the unit on or off. The Color button toggles the flame image from orange to blue. The Dimmer button will lower the brightness of the flame, the Bright button will make the fire image brighter. Press the Heat down arrow to set the heat to low, press the Heat up arrow to set the heat to high. Press either of these buttons twice to turn the heat off.

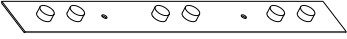
LANDSCAPE SERVICE PARTS		
ITEM	PHOTO	COMMENTS
MFPCB2		PRINTED CIRCUIT BOARD CONTROLS LOW VOLTAGE AND HIGH VOLTAGE FUNCTIONS
MFTC2		LCD TOUCH CONTROL
MFRR2		REMOTE CONTROL IR RECEIVER
MF12VT3		TRANSFORMER
HF12015-R		HEATER FAN 120 V 1500 WATTS RIGHT HAND
HF12015-L		HEATER FAN 120 V 1500 WATTS LEFT HAND
HC120V750		HEATER 120 V 750 WATTS
MFSM120		SPINDLE MOTOR 120 V 50-60 HZ

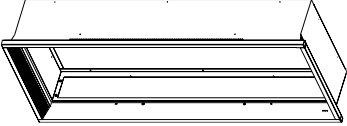
MAINTENANCE

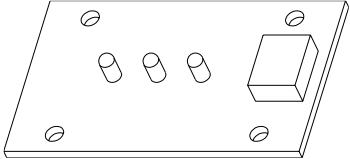
MFPLS240 LED		LED LIGHT STRIP LS2 40
MFPLS260 LED		LED LIGHT STRIP LS2 60
MFPLS280 LED		LED LIGHT STRIP LS2 80
MFPLS2100 LED		LED LIGHT STRIP LS2 100
MFPLS2120 LED		LED LIGHT STRIP LS2 120
MFPLS240 LED		EMBER BED LED LIGHT STRIP LS2 40
MFPLS260 LED		EMBER BED LED LIGHT STRIP LS2 60
MFPLS280 LED		EMBER BED LED LIGHT STRIP LS2 80
MFPLS2100 LED		EMBER BED LED LIGHT STRIP LS2 100
MFPLS2120 LED		EMBER BED LED LIGHT STRIP LS2 120
LFVGF40		INNER GLASS FACE
LFVGF60		
LFVGF80		
LFVGF100		
LFVGF120		
LFVDT40		ONE PIECE DECO TRIM
LFVDT60		
LFVDT80		
LFVDT100		
LFVDT120		
LFVIM40		INNER MODULE INCLUDING GLASS FACE, POLY SCREEN AND INDIVIDUAL BOX
LFVIM60		
LFVIM80		
LFVIM100		
LFVIM120		
MFR2		REMOTE CONTROL
MFTG-B		WALL MOUNTED TOUCH CONTROL FACE
LFVPIB		LED POWER INDICATOR BOARD

TROUBLESHOOTING

PROBLEM	POSSIBLE CAUSE	CORRECTIVE ACTION
Nothing comes on (touch screen, etc.)	A. Breaker tripped or circuit has no power	A. Reset breaker, test circuit for power
	B. Internal component is frozen and needs to be reset	B. Turn power off at the main breaker for 20 seconds. Turn power back on.
	C. Defective component	C. Qualified service technician needs to replace motherboard, transformer or LCD touch control
Touch Screen Comes on - then nothing	A. Not operating touch control properly with finger	A. Press flat part of finger firmly on the touch screen and apply moderate pressure
	B. Loose connection on motherboard	B. Check functions with remote control. if functional, check connections on motherboard
	C. Motherboard is defective	C. Replace Motherboard
Fireplace turns off and will not turn back on	A. Fireplace has overheated and safety disc has snapped or circuit breaker has tripped	A. Turn the main breaker to the "off" position for 30 seconds. Next flip the breaker back into the "on" position.
Can operate fireplace functions with touch controls but not remote control	A. Low Batteries	A. Replace batteries in remote control with 2 AA batteries
	B. Not aiming control correctly	B. Aim remote control to the upper right of the viewing area where sensor is located
	C. Remote control defective	C. Replace remote control
	D. Remote Sensor is defective	D. Replace remote sensor inside fireplace
Heater does not provide heat when on	A. Wiring is loose	A. Disconnect unit from power source and inspect for loose connections
	B. Thermal snap disc has been tripped	B. Turn the main breaker to the "off" position for 30 seconds. Next flip the breaker back into the "on" position.
	C. Heater core is defective	C. Replace Heater Core

MAINTENANCE

PROBLEM	POSSIBLE CAUSE	CORRECTIVE ACTION
Flame is not visible when unit is turned on	A. Wiring is loose	A. Disconnect unit from power source and inspect for loose connections
	B. Motherboard is defective	B. Replace motherboard
Fireplace lights up but there is no flame image	A. Wiring for motor is loose	A. Disconnect unit from power source and inspect for loose connections from motor
	B. Motor is defective	B. Replace motor
Fireplace is squeaking when flame image is on	A. Fireplace spindle/ rod is contacting to metal	A. Apply lithium grease or any standard grease to contacts with rod and metal
	B. Motor is defective	B. Replace motor

FREQUENTLY ASKED QUESTIONS

Q. How do you program the remote control?

A. The remote comes pre-programmed. No programming is necessary.

Q. What distance can the remote be used from the fireplace?

A. Optimal distance for the remote control is within 20 feet.

Q. Can you turn on the fireplace via the touch screen and off via the remote (or vice versa)?

A. Yes.

Q. How long will the LED lights last?

A. LED Lamps have a life span of up to 20 years.

Q. Can the fireplace be installed outside?

A. No. Please review the entire safety chapter before installing this fireplace.

Q. Does the fireplace need to be on a dedicated 15 amp circuit?

A. Yes.

Q. What thickness of sheetrock should be used for the recessed installation?

A. 1/2" or 5/8".

Q. How often do the batteries in the remote need to be replaced?

A. Annually, possibly more with heavy use.

Q. Is there a remote receiver in the fireplace that requires batteries?

A. No, only the actual remote requires batteries. The rest of the fireplace runs entirely off of the main power supply.

CLEANING AND MAINTENANCE INSTRUCTIONS

There is very little maintenance involved with your electric fireplace. Please follow the few points below:

- On a semi-annual basis remove the glass face of the fireplace and dust the fire unit with a dry cloth. Be careful not to brush any wires that may be exposed as you do this.
- To clean the glass face of the fireplace simply use your desired glass cleaner with paper towels.
- To clean the air inlets/outlets, wipe with a soft cloth or the nozzle of a vacuum cleaner
- Dust can easily build up around the heater area under the appliance. Take particular care to clean this area on a regular basis to prevent buildup.

WIRING DIAGRAM

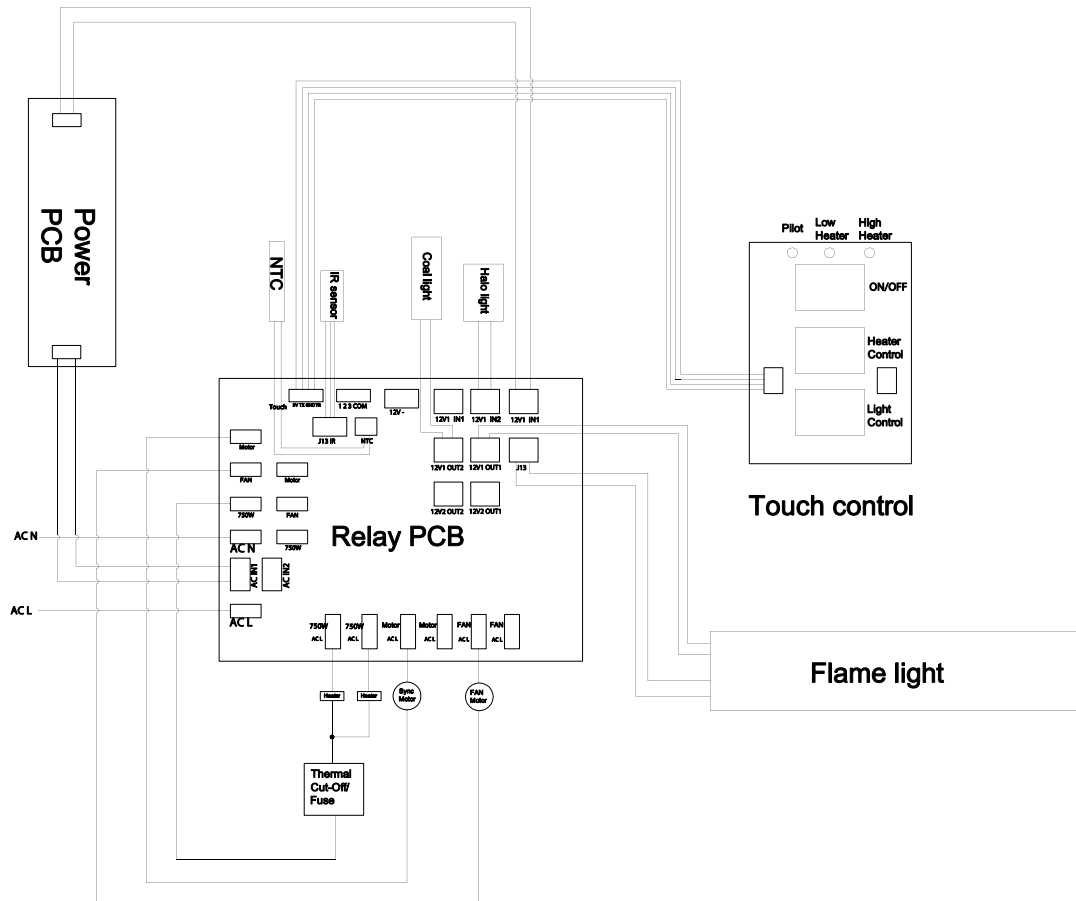

© 2013-2017

MODERN  FLAMES

www.modernflames.com
Please dispose of properly.

