

IGNITE XL[®] BOLD

Installation and User's Guide

Models

XLF5017-XD
XLF6017-XD
XLF7417-XD
XLF8817-XD
XLF10017-XD



We value your feedback!

Your input helps to create even better products and experiences.

Share the warmth and leave a review.

dimplex.com/sharethewarmth

 [YouTube/Dimplex](https://www.youtube.com/Dimplex) 



IMPORTANT SAFETY INFORMATION:

Read this manual first before attempting to install or use this electric fireplace. Always comply with the warnings and safety instructions contained in this manual to prevent personal injury or property damage.

To view the full line of Dimplex products, visit www.dimplex.com

Table of Contents

Welcome	3
IMPORTANT INSTRUCTIONS	4
FCC Compliance	5
Technical Specifications	6
Electrical Rating	6
UL Listing	6
Product Dimensions	6
Package Contents	7
Installation	9
Placement	9
Preparing the Firebox for Installation	10
Installation Instructions	11
Electrical Installation	14
Heater Hardware Disconnect	16
Mirrored Glass Installation	17
Media Arrangement	17
Side Glass Installation	18
Front Glass Installation	18
Operation	19
General Operation	19
Hidden Touch Controls	19
Remote Operation	19
App	19
Resetting the Temperature Cutoff Switch	22
Maintenance	23
Troubleshooting	24
Wiring Diagrams	25
Warranty	27

Conventions used in this manual:

! **NOTE:** Procedures and techniques that are considered important enough to emphasize.

 **CAUTION:** Procedures and techniques which, if not carefully followed, will result in damage to the equipment.

 **WARNING:** Procedures and techniques which, if not carefully followed, will expose the user to the risk of fire, serious injury, or death.

Welcome

Thank you and congratulations for choosing to purchase a Dimplex fireplace.

Please carefully read and save these instructions.

⚠ WARNING: Read all instructions and warnings carefully before starting installation. Failure to follow these instructions may result in a possible electric shock, fire hazard and will void the warranty.

Please record your model and serial numbers for future reference. Model and serial numbers can be found on the label located behind the front glass of your fireplace.

Model _____ MOD _____

Serial Number _____

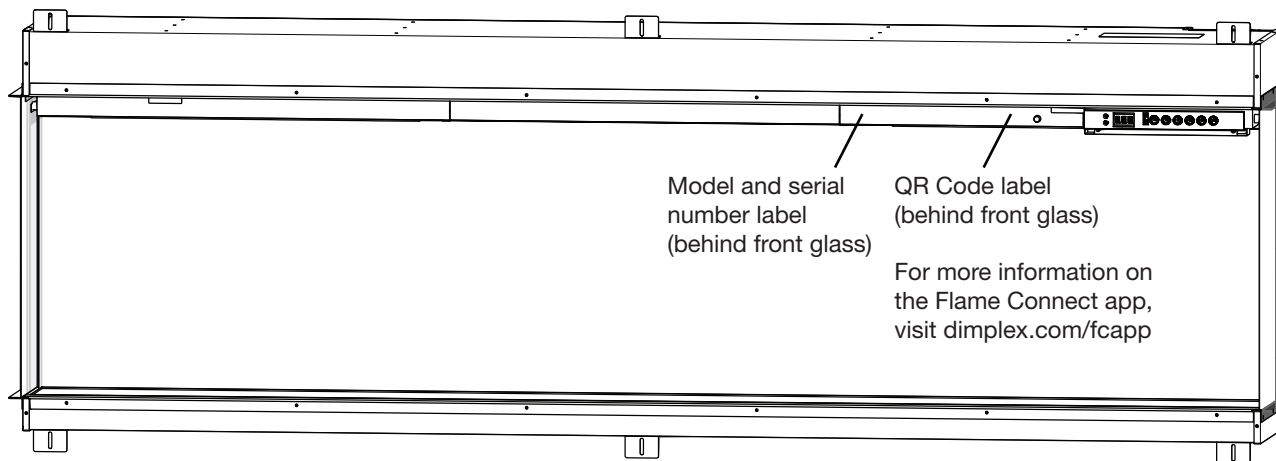

STOP NO NEED TO RETURN TO THE STORE

If you have questions regarding the operation of this product or if you require service, before returning this product to the place of purchase,

Contact us at:  www.dimplex.com/customer_support

For Troubleshooting and Technical Support

OR  **Toll-Free 1-888-346-7539**

Please have your model number and product serial number ready.

IMPORTANT INSTRUCTIONS

When using any electrical appliance, basic precautions should always be followed to reduce the risk of fire, electric shock, and injury to persons. These precautions include:

① Read all instructions before using this electric fireplace.

 **WARNING:** High temperatures may be generated under certain abnormal conditions. Do not partially or fully cover or obstruct the front of the fireplace.

② This fireplace is hot when in use. To avoid burns, do not let bare skin touch hot surfaces. The trim around the heater outlet becomes hot during heater operation. Keep combustible materials, such as furniture, pillows, bedding, papers, clothes, and curtains at least 3 feet (0.9 m) from the front of the fireplace.

③ Extreme caution is necessary when the fireplace is used by or near children or people with disabilities and whenever the fireplace is left operating and unattended.

④ Always turn off the fireplace when it is not in use.

⑤ Do not operate the fireplace after it malfunctions, has been dropped, or damaged in any manner. Disconnect power at the service panel and have the fireplace inspected by a reputable electrician before using.

⑥ Do not use this fireplace outdoors.

⑦ Never locate the fireplace where it may fall into a bathtub or other water container.

⑧ Do not insert or allow foreign objects to enter any ventilation or exhaust opening as this may cause an electric shock, fire, or damage to the fireplace.

⑨ To prevent a possible fire, do not block air intakes or exhaust in any manner.

⑩ To disconnect the heater, turn the unit off with the controls and turn off the power to the heater circuit at the main disconnect panel.

⑪ All electrical heaters have hot and arcing or sparking parts inside. Do not use it in areas where gasoline, paint, or flammable liquids are used or stored.

⑫ Do not modify this fireplace. Use it only as described in this manual. Any other use may cause fire, electric shock, or injury to persons.

⑬ Do not burn wood or other materials in this fireplace.

⑭ Disconnect all power coming to the fireplace at the main service panel before performing any cleaning or maintenance.

⑮ When transporting or storing the fireplace, keep it in a dry place, free from excessive vibration, and store to avoid damage.

⑯ Always use a qualified technician or service agency to repair this fireplace.

! NOTE: Changes or modifications not expressly approved by the party responsible for compliance could void user's authority to operate the equipment.

SAVE THESE INSTRUCTIONS



CAUTION
RISK OF ELECTRIC SHOCK
DO NOT OPEN
NO USER-SERVICEABLE PARTS INSIDE



IMPORTANT INSTRUCTIONS

FCC Compliance

 CAUTION: This unit has been tested and found to comply with the limits for Class B digital device, pursuant to part 15 of the FCC Rules. These limits are designed to provide reasonable protection against harmful interference in a residential installation. This unit generates, uses and can radiate radio frequency energy and, if not installed and used in accordance with the instructions, may cause harmful interference to radio or television reception, which can be determined by turning the unit OFF and ON, the user is encouraged to try to correct the interference by one or more of the following measures:

Reorient or relocate the receiving antenna.

Increase the separation between the unit and the receiver.

Connect the unit into an outlet on a circuit different from that to which the receiver is connected.

Consult the dealer or an experienced radio/TV technician for help.

This unit complies with Part 15 of the FCC Rules. Operation is subject to the following two conditions: (1) This unit may not cause harmful interference, and (2) this unit must accept any interference received, including interference that may cause undesired operation.

 FCC CAUTION: Any changes or modifications not expressly approved by the party responsible for compliance could void the user's authority to operate this equipment.

 WARNING: This product can expose you to chemicals including nickel which is known to the State of California to cause cancer. For more information, visit www.P65Warnings.ca.gov

Technical Specifications

Electrical Rating

Voltage: 120 V (3-Wire) or 240 V (4-Wire)

Power: 1500 W at 120 V, 2500 W at 240 V

UL Listing

File Number: E71416







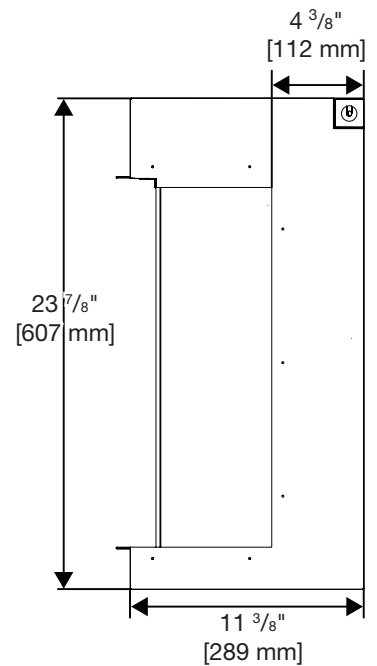
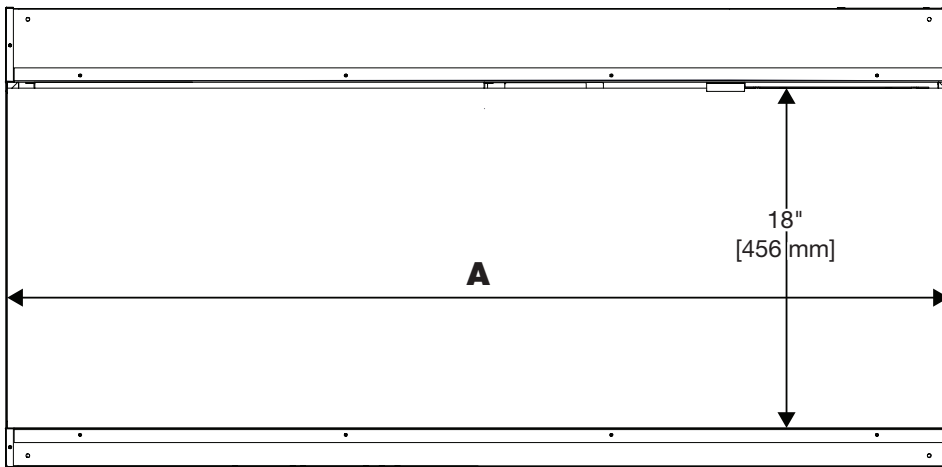

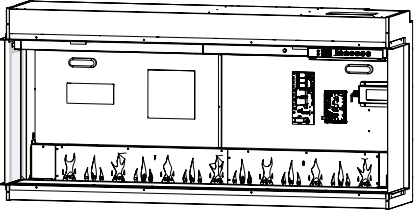
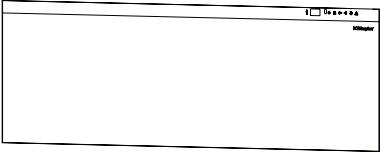
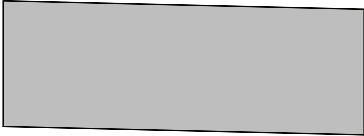

Model Reference	
XLF5017-XD	6911580000
XLF6017-XD	6911590000
XLF7417-XD	6911600000
XLF8817-XD	6911610000
XLF10017-XD	6911620000

Product Dimensions





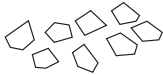

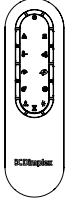

Model	A	
XLF5017-XD	49"	1246 mm
XLF6017-XD	61 ⁵ / ₈ "	1565 mm
XLF7417-XD	74 ¹ / ₈ "	1883 mm
XLF8817-XD	86 ¹¹ / ₁₆ "	2202 mm
XLF10017-XD	99 ¹ / ₄ "	2521 mm

Package Contents

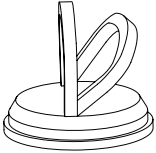
Image	Description	Quantity				
		XLF5017-XD	XLF6017-XD	XLF7417-XD	XLF8817-XD	XLF10017-XD
	Firebox	1	1	1	1	1
	Front Glass	1	1	1	1	1
	Mirrored Glass	1	1	1	1	1
	Side Glass	2	2	2	2	2
	Closed Side Trim	2	2	2	2	2
	Open Side Trim	2	2	2	2	2
	Mirrored Glass Bracket (lengths may vary)	2	2	3	3	3
	Bag of Small Acrylic Crystals	1	1	1	1	1
	Large Acrylic Crystals	5	6	7	7	9
	Extra-Large Acrylic Crystals	3	4	5	6	7

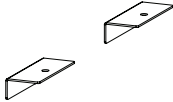
Package Contents

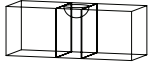
Image	Description	XLF5017-XD	XLF6017-XD	XLF7417-XD	XLF8817-XD	XLF10017-XD
	Driftwood	6	8	9	10	11
	Remote Control	1	1	1	1	1
	User's and Installation Guide	1	1	1	1	1
 <p><i>Do not dispose of the suction cup after installation. Keep it in a secure location as it will be helpful for maintenance and service of the unit.</i></p>	Suction Cup	1	1	1	1	1
Hardware Kit						
	Mounting Brackets	4	4	6	6	6
	Front Glass Brackets	1	2	2	2	2
	1" Wood Screws	4	4	4	6	6
	Black M3x10 Screws	11	14	14	18	18
	Bubble Level	1	1	1	1	1

Installation

Placement

! **NOTE:** It is recommended that the bottom of the unit be mounted between 5" (13 cm) and 40" (102 cm) from the ground to maintain an optimized viewing angle of the flame.

⚠ **WARNING:** The top of the fireplace must be installed a minimum of 24" (61 cm) from the ceiling. The fireplace must be installed a minimum of 5" (13 cm) from the ground.

Installation in a Bathroom

If this unit is installed in a bathroom, it must be protected by a GFCI receptacle or circuit. If a receptacle is used, it must be readily accessible.

This electrical appliance is NOT watertight. To prevent electric shock, it must be installed as to prevent water from entering unit, or installed away from showers, tubs, etc. Never locate fireplace where it may fall into a bathtub or other water container.

Wi-Fi

For installations where the use of the Flame Connect app is desired, ensure the fireplace is located within range of a Wi-Fi network.

Installation Recommendations for Overhanging Objects

For overhanging temperature-sensitive objects, such as a television, a mantel, or artwork, always follow the recommendations provided by its manufacturer for installation over a heater.

! **NOTE:** Using normal heat mode, surfaces 7" (18 cm) above the fireplace will not exceed 40° C, as long as installation procedures are followed and heater inlet and outlet are not obstructed.

Installation

Preparing the Firebox for Installation

! **NOTE:** For multi-unit installation, refer to instructions provided with the accessory kit (XLFXDLINK, sold separately).

1. Remove packing support brackets by removing the 2 screws on the top and on the 1 screw on the bottom of each bracket. (Figure 1) These brackets and screws can be discarded.
2. Install the desired side trim option on each side of the firebox. Install the side panel using 7 black screws.
 - For open sides, select the open side trim. (Figure 2)
 - For closed sides, install the closed side trim. (Figure 3) Do not install the side glass panels in this configuration.
 - For multi-unit installations, remove side panels on adjoining sides by removing the 9 screws. (Figure 4) Do not install any trim or side glass on adjoining sides.
3. Install the optional power cord accessory if desired, following the instructions in the *Electrical Installation* section (p. 15). (XLFXDPLUG, sold separately)
4. If a permanently heat-disabled installation is desired, follow the instructions to disable the heater in the *Permanent Heat Disable* section (p. 16).
5. Carefully lay the firebox on its back and install the mounting brackets to the top and bottom of the firebox with the black screws provided. (Figure 5)

! **NOTE:** There are 4 mounting brackets for XLF5017-XD and XLF6017-XD units (Figure 6), and 6 mounting brackets for XLF7417-XD, XLF8817-XD and XLF10017-XD units. (Figure 7)

! **NOTE:** The mounting brackets are equipped with slots to allow small adjustments to fit the framing. Ensure all the brackets are aligned.

Figure 1

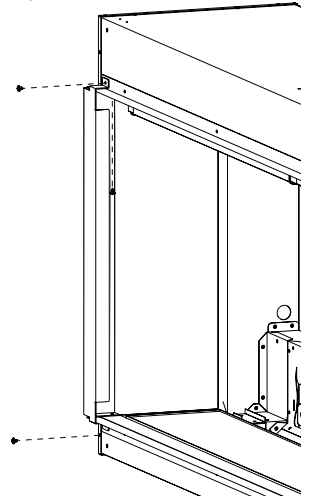

Figure 2

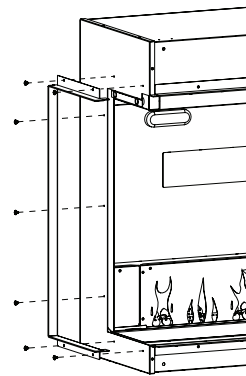

Figure 3

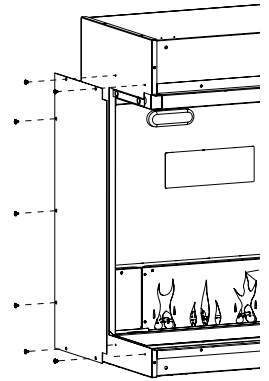

Figure 5

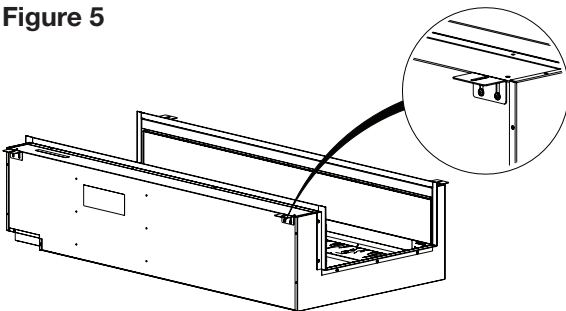

Figure 6

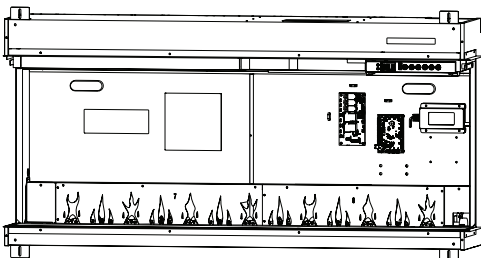

Figure 7

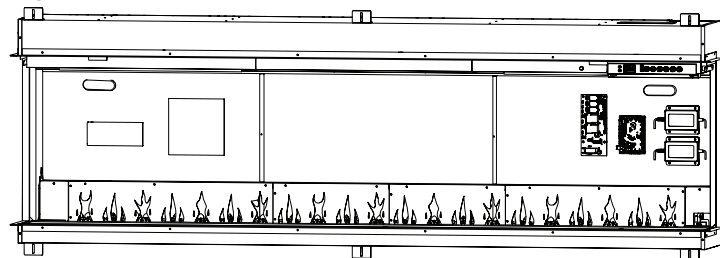
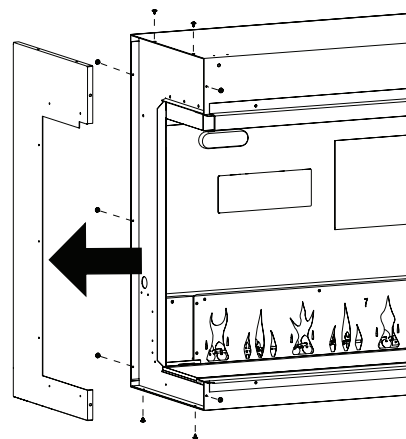

Figure 4



Installation

Installation Instructions

! **NOTE:** Two people are required for installation.

1. Prepare a wall with a framed opening, following the dimensions in the table below. The dimensions are the same for front, corner, and bay installations.

Framing Dimensions

Model	Width	Height	Depth (minimum)
	A	B	C
XLF5017-XD	49 1/2" 1257 mm	24 1/4" 616 mm	11 5/8" 295 mm
XLF6017-XD	62 1/4" 1581 mm		
XLF7417-XD	74 5/8" 1895 mm		
XLF8817-XD	87 3/16" 2215 mm		
XLF10017-XD	99 3/4" 2534 mm		
Custom Length	Add widths of units used		

⚠ **CAUTION:** This fireplace is **NOT** load-bearing. Ensure the opening for the fireplace is framed in such a way that the weight of the building materials will not create pressure on the top of the fireplace.

! **NOTE:** Wiring is located at the top right back corner of the firebox. Plan the framing to allow routing the power cable to this location.

Figure 9

Left/Right Corner Installation

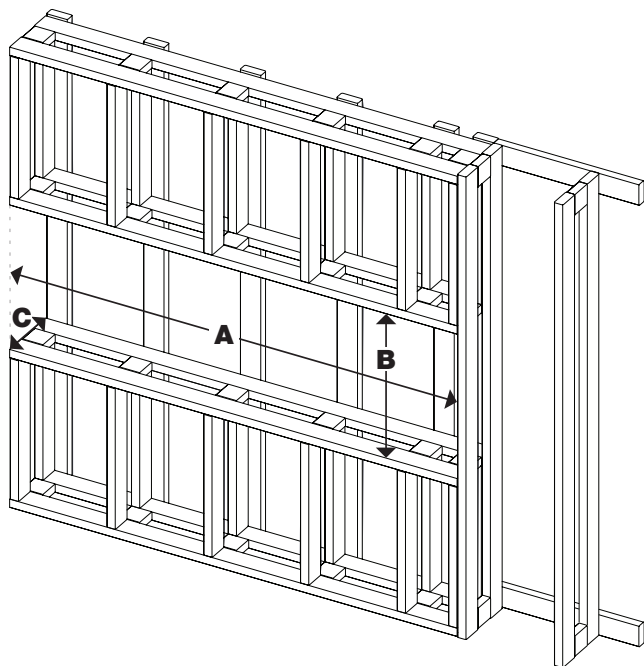

Figure 8

Bay Installation

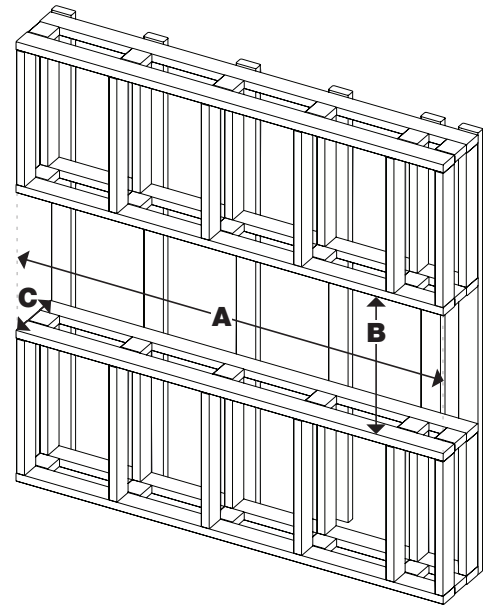
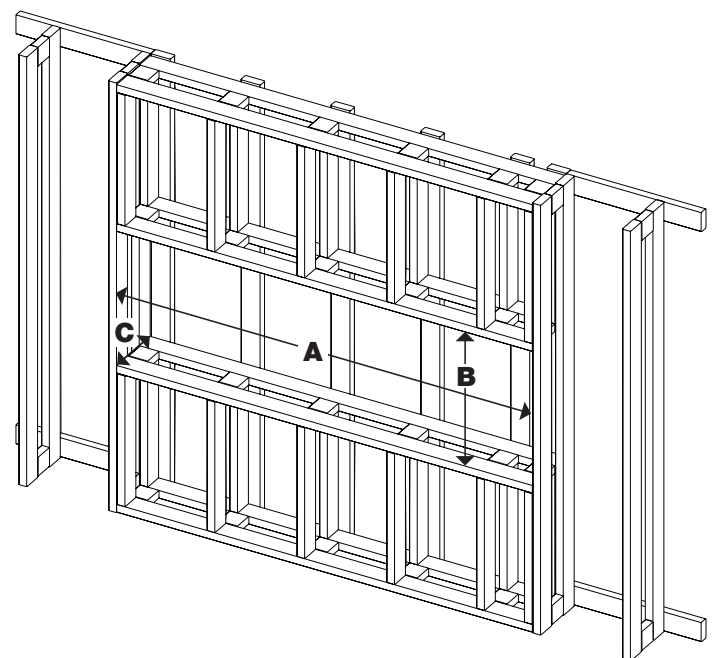

Figure 10

Front Installation



Installation

2. Lift the firebox into the opening in the frame using the handles on the back of the fireplace.

! NOTE: Ensure the instructions for *Preparing the Firebox for Installation* (p. 10) have been completed prior to installation.

3. Remove the screws that secure the electrical cover to complete the wiring. (Figure 11)
4. Complete the wiring according to instructions in the *Electrical Installation* section (pages 14–15). Reinstall the electrical cover after completing wiring.
5. Level the firebox. A bubble level is included in the hardware kit provided.
6. For multi-unit installations, install the joining brackets between adjoining fireplaces. (Figure 12)

Figure 11

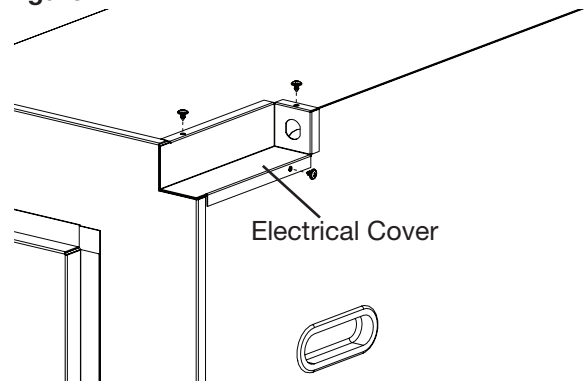
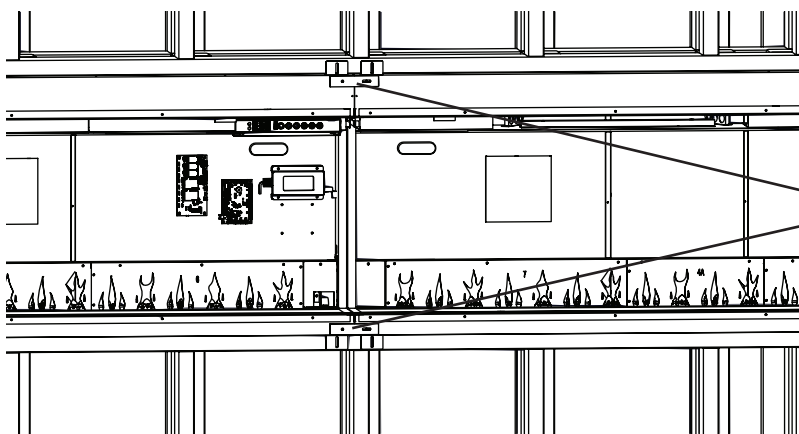
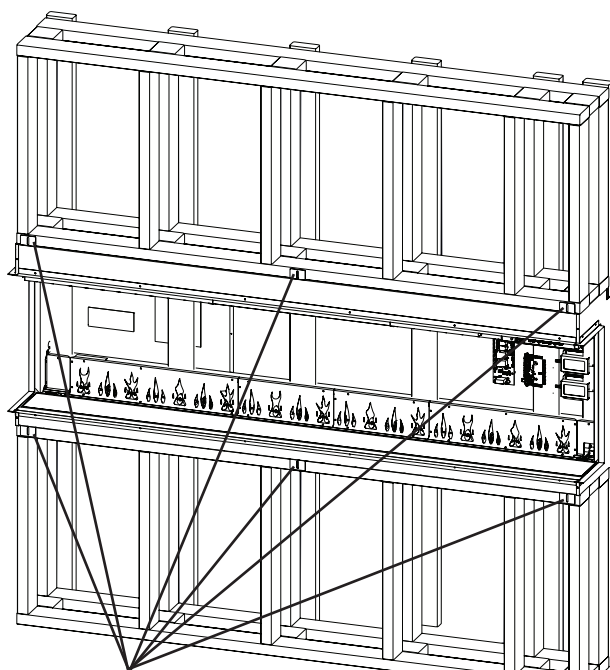

Figure 12



Adjoining brackets for multi-unit installations (included in XLFXDLINK, sold separately)

Figure 13



Mounting brackets
(center brackets not present on
XLF5017-XD and XLF6017-XD units)

7. Secure the mounting brackets to the framing on both the top and bottom using the provided wood screws. (Figure 13) The mounting brackets will prevent the firebox from shifting in the framing.
8. Install finishing material up to the trim. (Figures 14 and 15)
- ⚠ CAUTION:** Do not drill into firebox housing.
9. Finish the installation using the finishing materials of your choice.
10. Complete the installation using the instructions in the following sections: *Mirrored Glass Installation* (p. 17), *Arranging Media* (p. 17), *Front Glass Installation* (p. 18), and *Side Glass Installation* (p. 18).

Installation

Figure 14

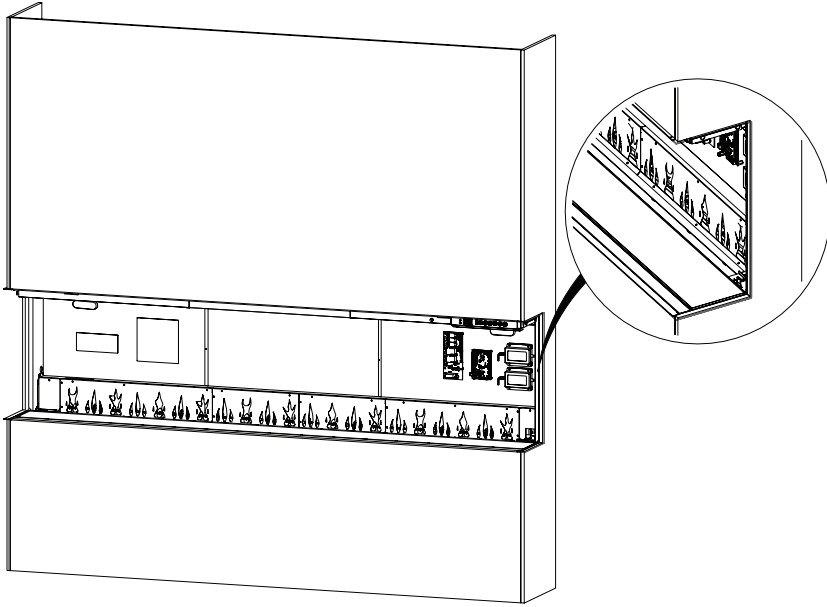
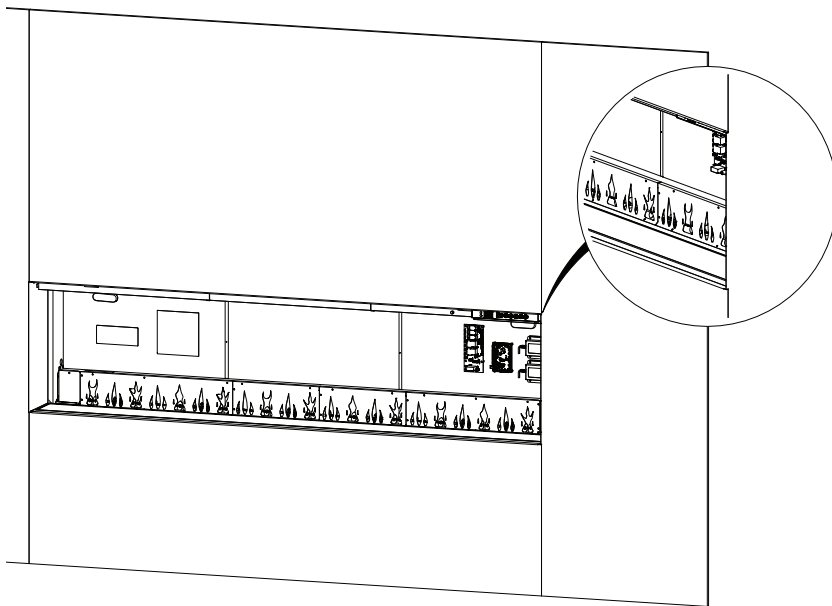

Figure 15



Electrical Installation

- ⚠ WARNING:** The installation of the electric fireplace must comply with the applicable Local and/or National Electrical Codes and utility requirements.
- ⚠ CAUTION:** A dedicated, properly fused 15 Amp circuit is recommended, rated for the appropriate voltage (120 V, 240 V). A dedicated circuit will be required if, after installation, the circuit breaker trips or fuse blows on a regular basis when the heater is operating. Additional appliances on the same circuit may exceed the current rating of the circuit breaker.
- ! NOTE:** If required, the service cable can be secured through the electrical cover using a ½" (1.3 cm) approved strain relief connector.

120 V Hardwire Installation (Figure 16)

- ⚠ WARNING:** Use the appropriate wire to meet local and national electrical codes for rated power consumption.
1. Cut the wire to an appropriate length.
 2. Connect the black L1 wire from the unit to the live wire from the power supply with a wire connector.
 3. Connect the white N wire from the unit to the neutral wire from the power supply with a wire connector.
 4. Connect the green G wire from the unit to the ground wire from the power supply with a wire connector or attach the grounding wire to the cover with the provided grounding screw, by placing the wire in between screw and lock washer and tighten.
 5. Ensure all wire connections are tight.

Figure 16

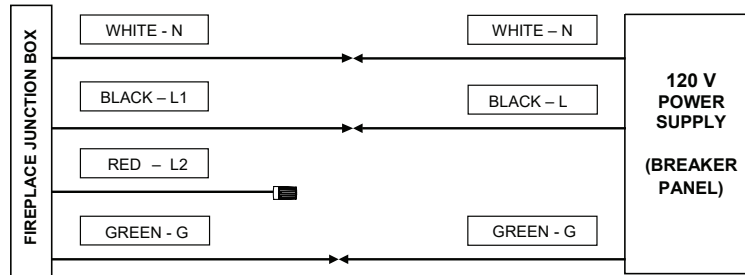

120V Installation—Wall Switch (Figure 17)

- ! NOTE:** Use a single pole, single throw (On/Off) wall switch that is rated for a minimum of 15 amps.
 - ⚠ WARNING:** Use the appropriate wire to meet local and national electrical codes for rated power consumption.
1. Cut the wire to an appropriate length.
 2. Connect the black L1 wire from the unit to the live wire from the main power through the wall switch, ensuring all live connections are connected with a wire connector.
 3. Connect the white N wire from the unit to the neutral wire from the power supply with a wire connector.
 4. Connect the green G wire from the unit to the ground wire from the power supply with a wire connector or attach the grounding wire to the cover with the provided grounding screw, by placing the wire in between screw and lock washer and tighten.
 5. Ensure all wire connections are tight.

Figure 17

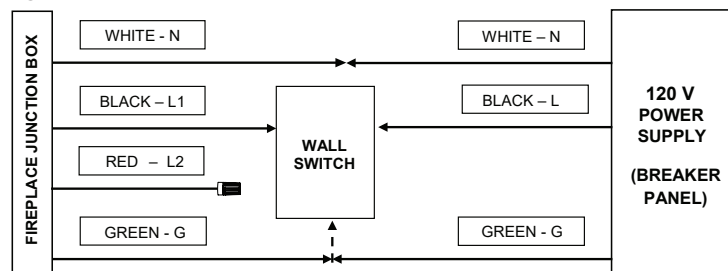

Installation

240 V Hardwire Installation (Figure 18)

You will need a 4-wire 240 V supply (L1, L2, Neutral, and Ground).

⚠ WARNING: Use the appropriate wire to meet local and national electrical codes for rated power consumption.

1. Connect the black L1 wire from the unit to the L1 wire from the power supply with a wire connector.
2. Connect the red L2 wire from the unit to the L2 wire from the power supply with a wire connector.
3. Connect the white N wire from the unit to the neutral wire from the power supply.
4. Connect the green G wire from the unit to the ground wire from the power supply with a wire connector or attach the grounding wire.
5. Ensure all wire connections are tight.

Figure 18



Optional Plug Kit (XLFXDPLUG, sold separately)

⚠ WARNING: Power cord option is only suitable for 120 V installations.

1. Remove the 3 screws that hold the electrical cover plate.
2. Connect the black L1 wire from the unit to the black wire of the plug kit.
3. Connect the white N wire from the fireplace to the white wire from the plug kit.
4. Connect green G wire from the fireplace to the green wire from the plug kit.
5. Ensure all wire connections are tight.
6. Secure the power cord's pre-installed cover plate using the screws removed when removing the electrical cover plate. The previously removed electrical cover plate can be disposed of.

⚠ WARNING: This heater is not intended for use with an extension cord. Plug the cord directly into an appropriate wall receptacle.

Heater Hardware Disconnect

The fireplace heater can be permanently disabled by removing the electronic jumper on the main control board.

! NOTE: Heater hardware disconnect will permanently disable the heater and fan. Follow these instructions only when an installation without heat is required. Temporary disabling of the heater can be achieved through the hidden touch controls. See “Heat Disable” in *Operation* section (p. 20) for instructions.

To disconnect the heater and fan permanently:

1. Locate the main control board. The heater hardware disconnect jumper location is labeled “Heater Disable”. (Figure 19)
2. Pull out the heater hardware disconnect jumper.

Figure 19

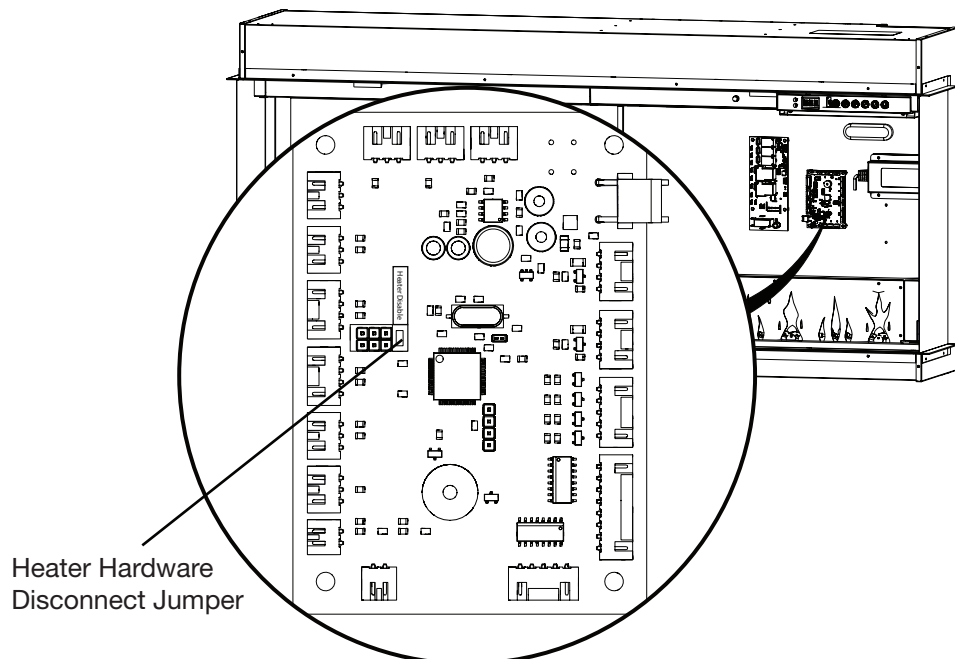

Installation

Mirrored Glass Installation

1. Attach the provided suction cup to the reflective side of the mirrored glass. Ensure the suction cup is securely attached.
2. Using the suction cup to assist, lift the mirrored glass and place it into the bottom slot at an angle.
3. Tilt the mirrored glass into a vertical position. (Figure 20)
4. Install the mirrored glass brackets to hold the glass in place using the provided black screws. (Figure 21)

⚠ CAUTION: Ensure the mirrored glass does not fall forward while the mirrored glass mounting brackets are being installed.

5. Remove the suction cup and clean any fingerprints or debris off the glass with a non-abrasive glass cleaner.

! NOTE: Do not dispose of the suction cup! Keep it in a secure location, as it may be needed for maintenance and service on this fireplace.

Figure 20

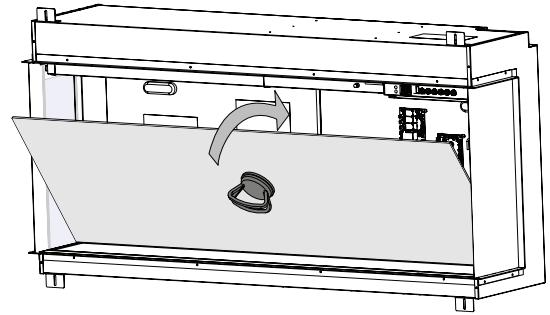
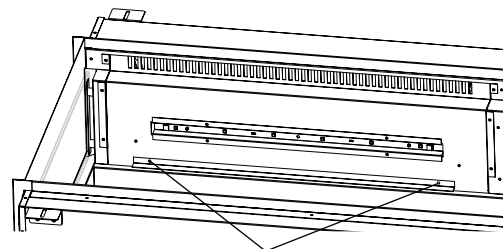

Figure 21



Mirrored Glass Bracket
Screws

Media Arrangement

For best results when using the supplied media, arrange as follows:

1. Evenly disperse the small crystals to entirely cover the media bed.
2. Place the driftwood pieces across the crystals.
3. Place the large and extra-large crystals as desired over the smaller crystals and beside the driftwood.

It is possible to use custom media ornaments to decorate your firebox. The custom media must fit easily without scratching the glass or bowing the media bed, and must not be composed of sand or liquid, which could interfere with the safety of the firebox.

Figure 22

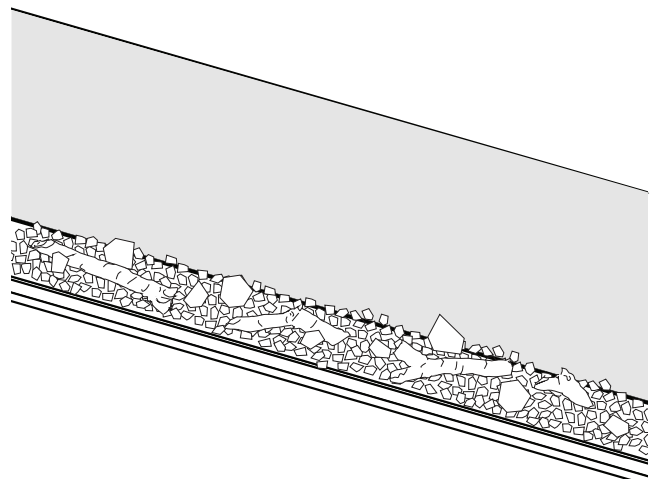

Side Glass Installation

1. Ensure the matte side of the upper black trimming is oriented toward the inside.
2. Insert the top of the glass panel into the upper slot.
3. Carefully tilt it toward the inside until it is in the vertical position. Once in place, it will drop into the correct position. (Figure 23)
4. Repeat on the other side for bay installations.

Figure 23

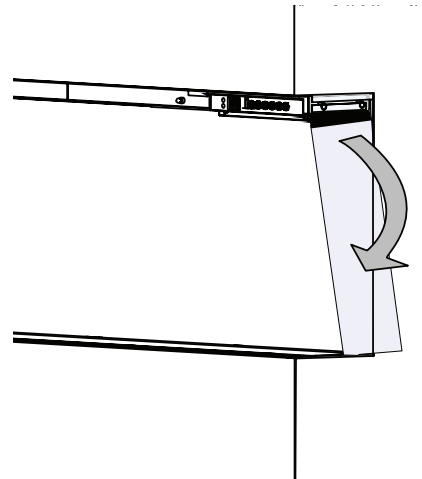

Front Glass Installation

1. Ensure there are no debris or finger prints on the mirrored glass, inner sides of the side glass, or on the inner side of the front glass before you begin.
2. Attach the provided suction cup to the outer side of the front glass. Ensure the suction cup is securely attached.
3. Using the suction cup to assist, lift the glass and place it into the bottom slot at an angle.
4. Tilt the glass into a vertical position. (Figure 24)
5. Secure using the provided front glass brackets and black screws provided. (Figure 25)

Figure 24

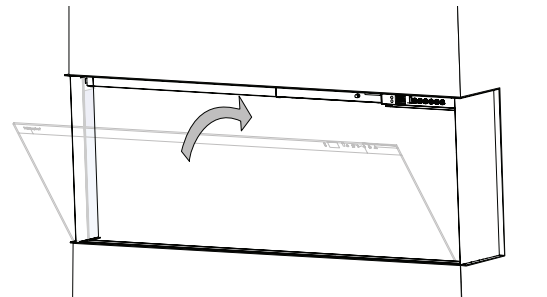

- ! **NOTE:** There is 1 front glass bracket for the XLF5017-XD, 2 front glass brackets for XLF6017-XD and XLF7417-XD units and 3 front glass brackets for XLF8817-XD and XLF10017-XD units.

- ! **CAUTION:** Ensure the front glass does not fall forward while the glass mounting brackets are being installed.

6. Remove the suction cup and clean any fingerprints or debris off the glass with a nonabrasive glass cleaner.

- ! **NOTE:** Do not dispose of the suction cup! Keep it in a secure location, as it may be needed for maintenance and service on this fireplace.

Figure 25

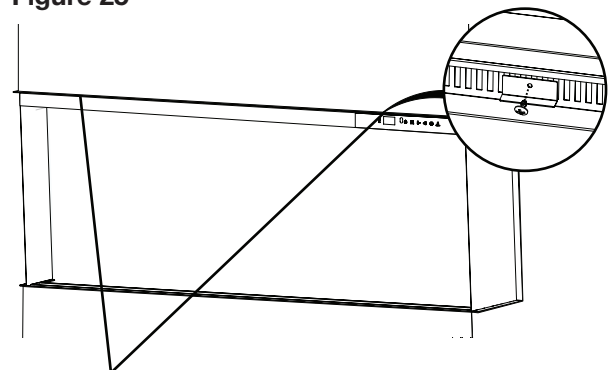

Front Glass Brackets

Operation

General Operation

⚠ WARNING: This electric firebox must be properly installed before it is used.

This firebox operates with ComfortSaver™ technology, which automatically adjusts the fan speed and heater wattage to safely and precisely match the requirements of the room based on the thermostat setting. The heater operates such that once the room reaches the set point, the fan and heater will continuously run at a low level, to maintain the desired room temperature. If the temperature in the room rises significantly, the heater will turn off and periodically turn back on to circulate the air around the unit, until the room temperature drops and requires the heater to be on again.

! NOTE: The element retains heat after shutdown. When the heat is turned off, there is a 2-minute cool down period before the fan shuts off completely.

! NOTE: The fireplace will retain the previously used settings after a power interruption.

Hidden Touch Controls

The hidden touch controls are located on the upper right of the fireplace. (Figure 26)

Remote Operation

The fireplace is supplied with a multifunction IR remote control. (Figure 27)

! NOTE: To operate correctly, the remote control must be pointed toward the front of the unit.

App

The fireplace is capable of being controlled using the Flame Connect app for mobile devices. For up-to-date information about the app, please visit www.dimplex.com/fcapp

Figure 26

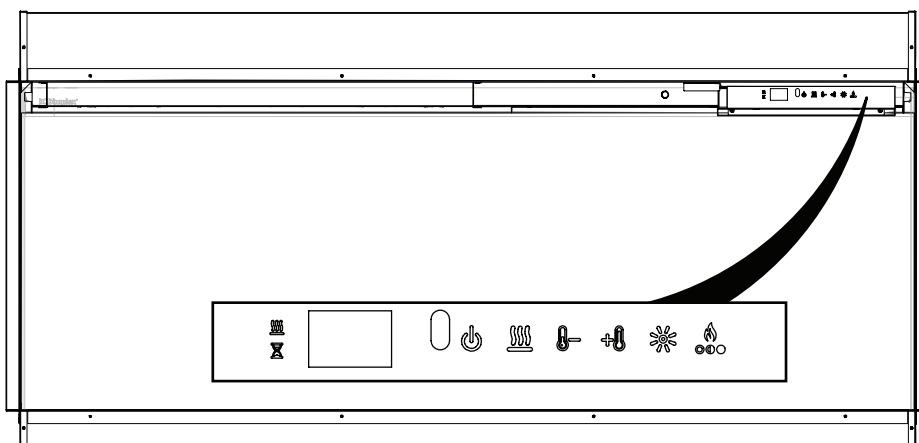
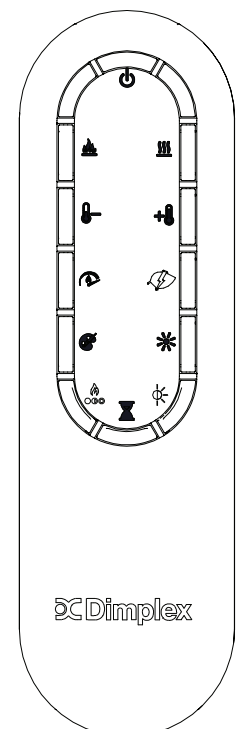









































Figure 27



Operation

	Standby	Press  to turn on the unit or to put it in standby mode. When the unit is turned back on, it will retain the previously used settings.
	Flame Effect	Press  to turn the flame effect, media, and overhead lights on or off.
	Heat	Press  to turn the heat on or off. The fireplace will beep once and the  icon will remain on the display when activated. The fireplace can be operated in heat only mode by turning off the flame and color effects.
	Heat Disable	Press and hold  and  at the same time for 3 seconds to disable or enable the heat function. This action must be performed on the hidden touch controls . When the heat is disabled and either the  ,  , or  is pressed, --- will appear on the display.
	Temperature Increase	Press  to increase the temperature setting.
	Temperature Decrease	Press  to decrease the temperature setting.
	Temperature Display (°C ↔ °F)	The temperature can be set from 7° C to 30° C (45° F to 86° F). When the temperature setting is adjusted, the set temperature will flash for 2 seconds, then the ambient room temperature will be displayed briefly.
	Temperature Display (°C ↔ °F)	Press and hold  and  at the same time for 3 seconds. This action must be performed on the hidden touch controls .
	Flame Speed	Press  repeatedly to cycle through the 5 different flame speeds.
	Heat Mode	Press  repeatedly to cycle through the 4 different heater modes: Normal: The element will automatically adjust itself to achieve and maintain the set temperature. Eco: The element will work at reduced power to save energy. Heat Boost: The element will work at maximum power for 20 minutes, then revert to normal heater mode. Fan: The element will turn off and only the fan will run.
	Moods	Press  repeatedly to cycle through the 8 different Moods, which are different combinations of overhead and media bed lighting. 1 - White 2 - Blue 3 - Violet 4 - Red 5 - Green 6 - Prism — media and flame base cycle through colors 7 - Kaleidoscope— media and flame base cycle through colors at different rates 8 - Midnight mode — media and overhead lights are off Press and hold  to turn the overhead lights on or off.
	Custom Color	Freeze the media and overhead lights to a custom color. When in Prism or Kaleidoscope modes (see Moods), press  while the desired color is displayed to freeze the cycle on that color. Press  again to resume the color cycle.

Operation

	Brightness	Press  repeatedly to cycle through the brightness and flicker modes. Solid <i>L</i> - Low Brightness Solid <i>H</i> - High Brightness Cycle <i>L</i> - Low Brightness with flickering media and overhead lights Cycle <i>H</i> - High Brightness with flickering media and overhead lights
	Flame Theme	Press  repeatedly to cycle through the 7 different flame themes: 1 - Base with orange and blue accents 2 - Base with orange accents 3 - Base with blue accents 4 - Blue 5 - Orange 6 - Base 7 - Orange and blue
	Ambient Light Sensor	Press  to turn the ambient light sensor on or off. The ambient light sensor will automatically adjust the brightness of the fireplace lights based on the ambient light in the room.
	Timer	Press  repeatedly until the desired number of hours of the timer is displayed. When this function is active, the fireplace will turn off after a set amount of time. The timer can be set from 30 minutes (display will show .5) to 8 hours in intervals of 30 minutes. To turn the timer off, press  repeatedly until  appears on the display. While the timer is active, press the timer button to see the time remaining.
	Factory Reset	Press and hold  and  at the same time for 3 seconds to reset all the settings to factory default. This action will also disconnect the unit from the Wi-Fi network if connected. This action must be performed on the hidden touch controls .

Resetting the Temperature Cutoff Switch

Should the heater overheat, a manual limit cut-out will turn the unit off and it will not come back on without being reset. If the  button on the unit is pressed, *Error* will be displayed on the unit. It can be reset by turning the unit off at the main disconnect panel and waiting 5 minutes before turning the unit back on.

⚠ CAUTION: If you need to continuously reset the heater, turn the unit off at the main disconnect panel and call technical support at: 1-888-346-7539.

Maintenance

Remote Control Battery Replacement

To replace the battery:

1. Remove battery cover of the remote control using a Philips screwdriver.
2. Correctly install one 3 Volt (CR2032 [longer life] or CR2025) battery in the battery holder with the + side facing up.
3. Secure the battery cover using the previously removed screw.



Battery must be recycled or disposed of properly. Check with your Local Authority or Retailer for recycling advice in your area.

Figure 28

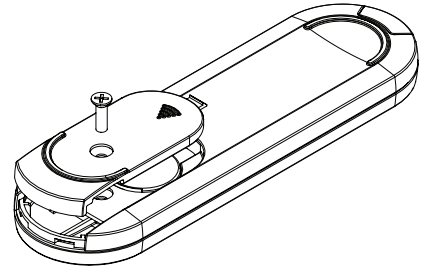

⚠WARNING: Disconnect power and allow heater to cool before attempting any maintenance or cleaning to reduce the risk of fire, electric shock or damage to persons.

Partially Reflective Glass Cleaning

The partially reflective glass is cleaned in the factory during the assembly operation. During shipment, installation, handling, etc., the partially reflective glass may collect dust particles; these can be removed by dusting lightly with a clean dry cloth.

To remove fingerprints or other marks, the partially reflective glass can be cleaned with a damp cloth. The partially reflective glass should be completely dried with a lint-free cloth to prevent water spots. To prevent scratching, do not use abrasive cleaners.

Fireplace Surface Cleaning

Use only a damp cloth to clean painted surfaces of the fireplace. Do not use abrasive cleaners.



The fireplace should not be operated with an accumulation of dust or dirt on or in the unit, as this can cause a build-up of heat and eventual damage. For this reason the heater must be inspected regularly, depending upon conditions and at a minimum yearly intervals.

Servicing

Except for installation and cleaning described in this manual, an authorized service representative should perform any other servicing.

Troubleshooting

For more troubleshooting, consult the XLF-XD Service Manual which can be found at www.dimplex.com/customer_support/technical_and_troubleshooting

Problem	Display	Cause	Solution
Fireplace does not turn on with the manual touch controls	N/A	No incoming power	Ensure unit is wired correctly Check main disconnect panel Ensure wall switch is on (if applicable)
Fireplace does not turn on with the remote control	N/A	The batteries in the remote control are dead or installed incorrectly	Replace remote control battery Ensure battery is installed with + facing up.
Heater does not turn on	---	Heater is disabled	Press and hold  and  at the same time on the hidden touch controls for 3 seconds to disable or enable the heat function.
	H--	Heater has been permanently disabled	If installation with heat is desired, reinstall jumper on main board if available or purchase new main board.
Heater is on, but there is no heat		Normal operation — There is a 30-second delay before heater starts	No action required.
Circuit breaker trips or fuse blows when unit is turned on	N/A	Improper circuit current rating	Install unit on a dedicated minimum 15 amp circuit.
Error Code is displayed	Err 1	Temperature cut-out is activated	Reset breaker and wait 5 minutes before turning unit back on it. If error persists, see Service Manual.
	Err 2	L1 voltage is too high	If error persists, consult an electrician.
	Err 3	L1 voltage is too low	If error persists, consult an electrician.
	Err 4	L1 current is too high	If error persists, consult an electrician.
	Err 5	Fan not detected	See service manual.
	Err 6	Fan error	See service manual.
	Err 7	Fan is slow	See service manual.
	Err 8	Element error	See service manual.
	Err 9	Element not detected	See service manual.
	Err 12	Ambient temperature is above 45° C (113° F)	No action required.
	Err 13	Ambient temperature is below 5° C (41° F)	No action required.
	Err 14	NTC error	See service manual.
	Err 15	NTC has shorted	See service manual.
	Err 16	NTC not detected	See service manual.
	Err 17	Media bed LEDs defective	See service manual.
	Err 18	Overhead LEDs defective	See service manual.
	Err 19	Media bed LEDs not detected	See service manual.
	Err 20	Overhead LEDs not detected	See service manual.
	Err 21	Flame LEDs not detected	See service manual.
	Err 22	Flicker motor not detected	See service manual.
	Err 23	Relay board not detected	See service manual.
	Err 24	Main control board not detected	See service manual.
	Err 25	Display board not detected	See service manual.

Wiring Diagrams

XLF5017-XD

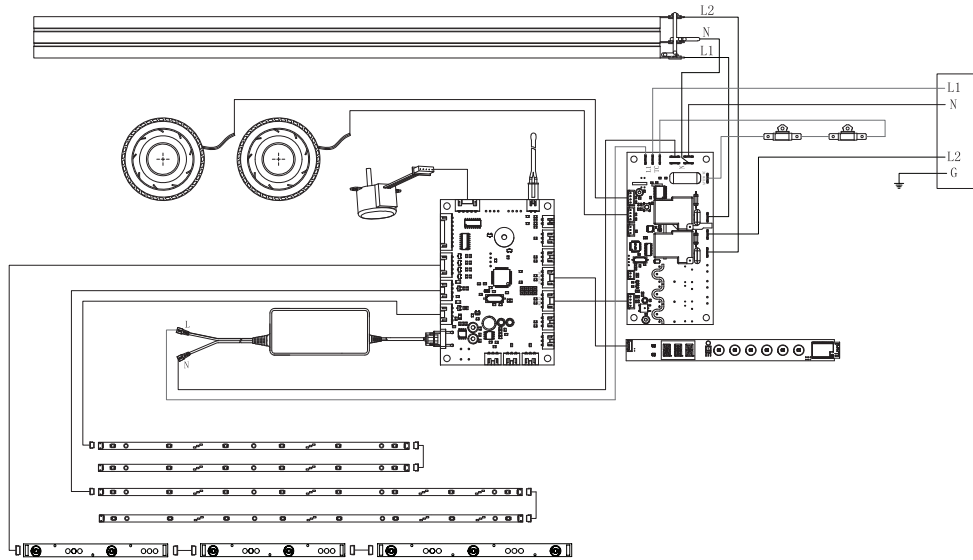

XLF6017-XD

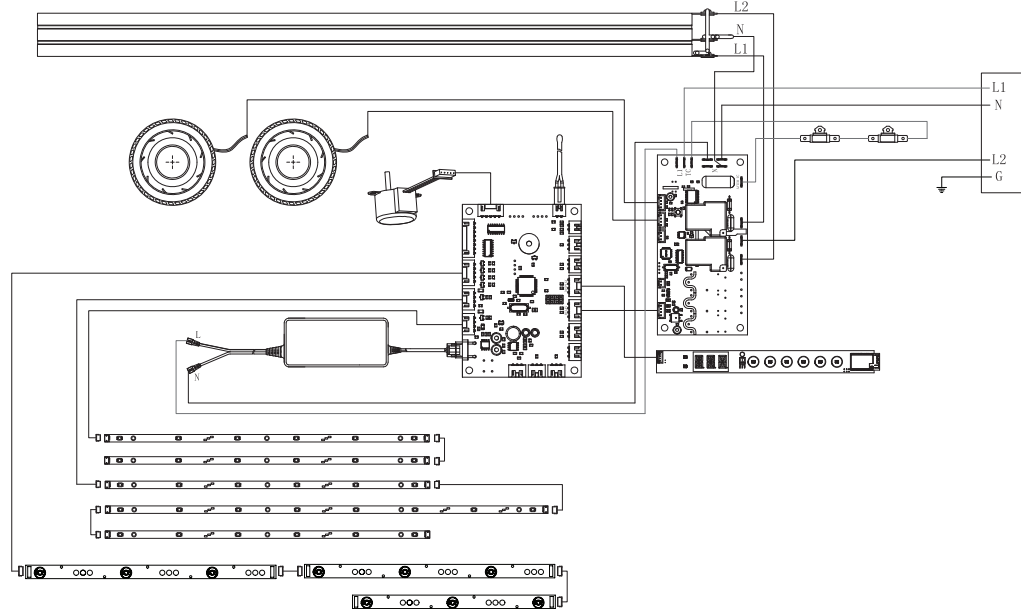

XLF7417-XD

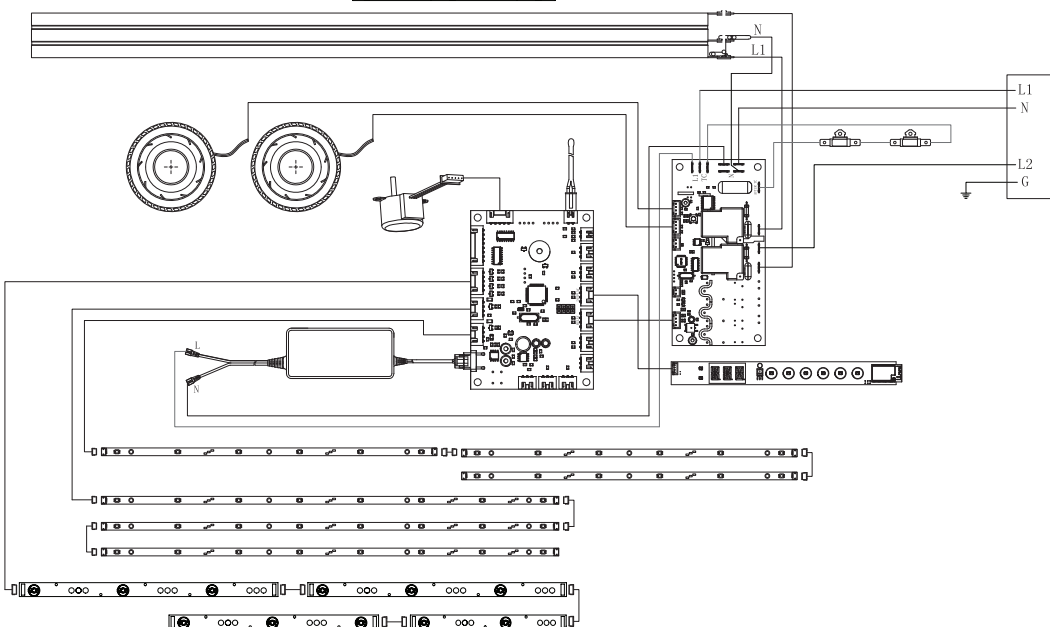

Wiring Diagrams

XLF8817-XD

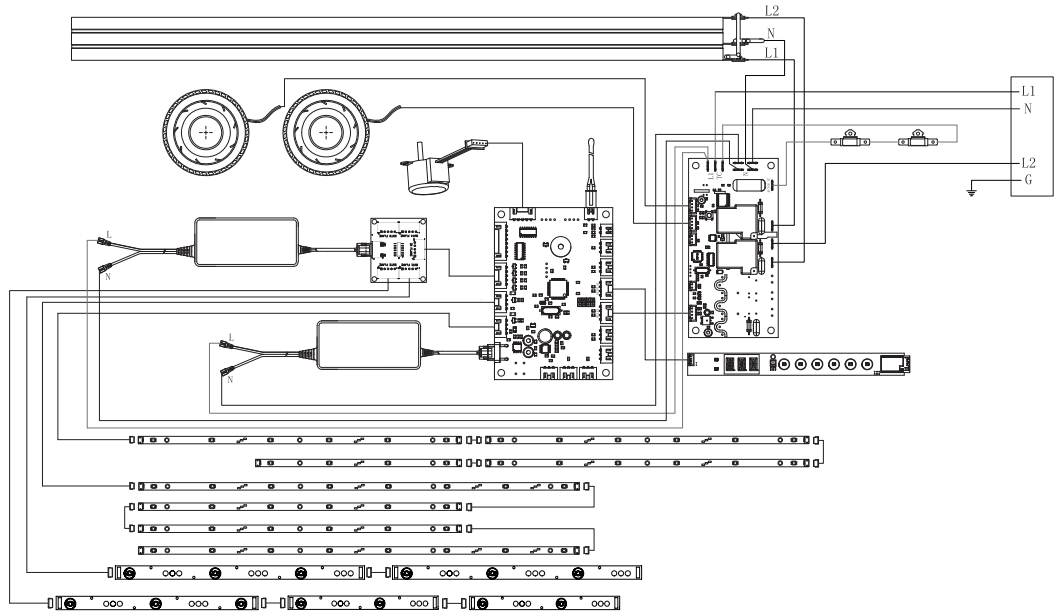

XLF10017-XD

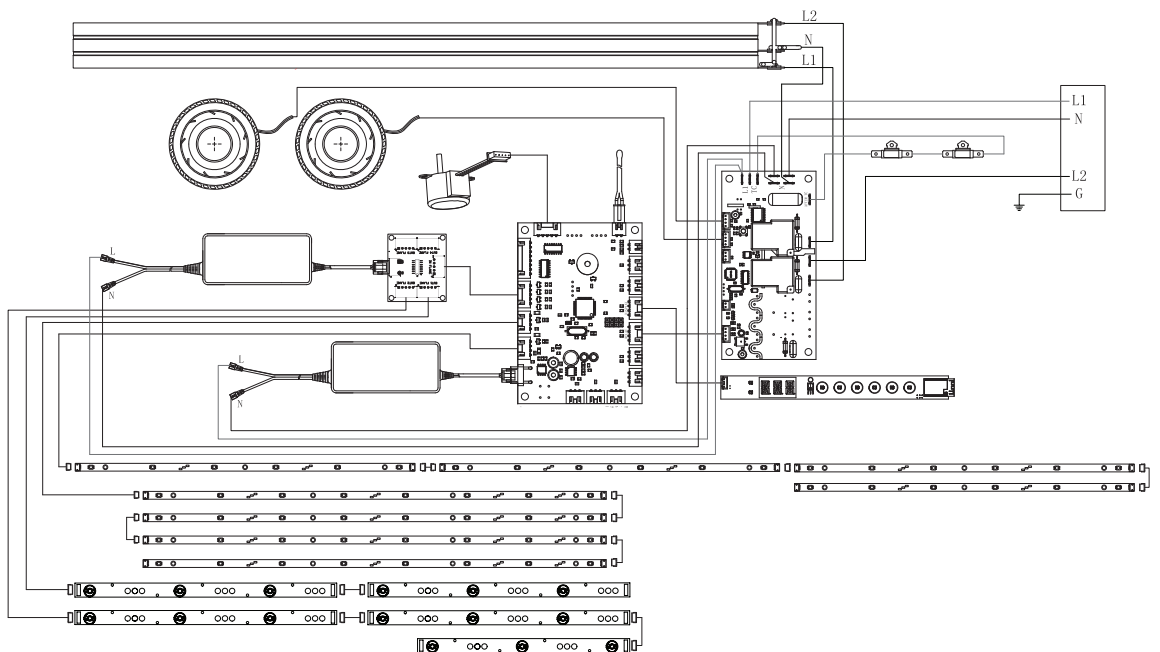

Warranty

IGNITEXL BOLD™ 5-YEAR LIMITED WARRANTY

Section 1 Products to which this Limited Warranty Applies

This Limited Warranty applies to your newly purchased Dimplex electric fireplace with model numbers XLF5017-XD, XLF6017-XD, XLF7417-XD, XLF8817-XD, and XLF10017-XD.

This Limited Warranty applies only to purchases made in any province of Canada except for Yukon Territory, Nunavut, or Northwest Territories or in any of the 50 States of the USA and the District of Columbia except for Hawaii and Alaska. This Limited Warranty applies to the original purchaser of the product only and is not transferable.

Section 2 Products excluded from this Limited Warranty

Products purchased in Yukon Territory, Nunavut, Northwest Territories, Hawaii, or Alaska are not covered by this Limited Warranty. Products purchased in these States, Provinces, or Territories are sold AS IS without Warranty or condition of any kind including, without limitation, any implied warranties or conditions of merchantability or fitness for a particular purpose. The entire risk of as to the quality and performance of the products is with the purchaser. In the event of a defect, the purchaser assumes the entire cost of all necessary servicing or repair.

Section 3 What this Limited Warranty covers and for How Long

IgniteXL Bold™ products XLF5017-XD, XLF6017-XD, XLF7417-XD, XLF8817-XD, and XLF10017-XD excluding trims and accessory packages are covered by this Limited Warranty, have been tested and inspected prior to shipment and, subject to the provisions of this Warranty, Glen Dimplex Americas Ltd. (herein called Glen Dimplex Americas) warrants such products to be free from defects in material and workmanship for a period of 5 years from the date of the first purchase of such products. The 5-year Limited Warranty entitles the purchaser to On-site or In-home Warranty Services. Accordingly, Glen Dimplex Americas will be responsible for all labor and transportation associated with repairing or replacing the product or part. Exceptions to this are outlined in Section 5. Some jurisdictions do not allow limitations on how long an implied Warranty lasts, so the above limitation may not apply to the purchaser.

Section 4 What this Limited Warranty Does Not Cover

This Limited Warranty does not apply to products that have been repaired (except by Glen Dimplex Americas or its authorized service representatives) or otherwise altered. This Limited Warranty does further not apply to defects resulting from misuse, abuse, accident, neglect, incorrect installation, improper maintenance or handling, or operation with an incorrect power source.

Section 5 How to notify us of a Warranty Concern

Defects must be brought to the attention of Dimplex Customer Service online at dimplex.com/en/contact_us or by telephone at 1-888-346-7539. Please have proof of purchase, catalogue/model and serial numbers available for representatives to assist. **Limited In-home Warranty Services require proof of purchase.

In the event a product or part covered by this Limited Warranty is proven to be defective in material or workmanship during (i) the 5-year Limited Warranty period

for products outlined in Section 1, you have the following rights:

- Glen Dimplex Americas will in its sole discretion either repair or replace such defective product or part without charge. If Glen Dimplex Americas is unable to repair or replace such product or part, or if repair or replacement is not commercially practicable or cannot be timely made, Glen Dimplex Americas may, in lieu of repair or replacement, choose to refund the purchase price for such product or part.
- Limited Warranty service will be performed solely by dealers or service agents of Glen Dimplex Americas authorized to provide Limited Warranty services.
- This 5-year Limited Warranty entitles the purchaser to On-site or In-home Warranty services. Accordingly, Glen Dimplex Americas will be responsible for all labor and transportation associated with repairing or replacing the product or part except as follows: (i) charges which may be levied for travel costs incurred to travel to the purchaser's site where the product is located if the purchaser's site is beyond 30 miles (48 km) from the closest service depot of Glen Dimplex Americas dealer or service agent; and (ii) the purchaser is solely responsible for providing clear access to all serviceable parts of the product.
- Glen Dimplex Americas will not be responsible for, and this Limited Warranty shall not include, any expense incurred for installation or removal of the surrounds (mantels) or trims or any part thereof (or any replacement product or part) including, without limitation, all shipping costs and transportation costs to and from the authorized dealer's or service agent's place of business and all labor costs. Such costs shall be the purchaser's sole responsibility.

Section 6 When Glen Dimplex Americas and its Dealers and Service Agents are not Liable

IN NO EVENT WILL GLEN DIMPLEX AMERICAS, OR ITS DIRECTORS, OFFICERS, OR AGENTS, BE LIABLE TO THE PURCHASER OR ANY THIRD PARTY. WHETHER IN CONTRACT, IN TORT, OR ON ANY OTHER BASIS, FOR ANY INDIRECT, SPECIAL, PUNITIVE, EXEMPLARY, CONSEQUENTIAL, OR INCIDENTAL LOSS, COST, OR DAMAGE ARISING OUT OF OR IN CONNECTION WITH THE SALE, MAINTENANCE, USE, OR INABILITY TO USE THE PRODUCT, EVEN IF GLEN DIMPLEX AMERICAS OR ITS DIRECTORS, OFFICERS, OR AGENTS HAVE BEEN ADVISED OF THE POSSIBILITY OF SUCH LOSSES, COSTS OR DAMAGES, OR IF SUCH LOSSES, COSTS, OR DAMAGES ARE FORESEEABLE. IN NO EVENT WILL GLEN DIMPLEX AMERICAS, OR ITS OFFICERS, DIRECTORS, OR AGENTS BE LIABLE FOR ANY DIRECT LOSSES, COSTS, OR DAMAGES THAT EXCEED THE PURCHASE PRICE OF THE PRODUCT. SOME JURISDICTIONS DO NOT ALLOW THE EXCLUSION OR LIMITATION OF INCIDENTAL OR CONSEQUENTIAL DAMAGES, SO THE ABOVE LIMITATION OR EXCLUSION MAY NOT APPLY TO THE PURCHASER.

How State and Provincial law(s) apply

This Limited Warranty gives you specific legal rights, and you may also have other rights which vary from jurisdiction to jurisdiction. The provisions of the United Nations Convention on Contracts for the Sale of Goods shall not apply to this Limited Warranty or the sale of products covered by this Limited Warranty.

We value your feedback!

Your input helps to create even better products and experiences.

Share the warmth and leave a review.

dimplex.com/sharethewarmth

 [YouTube/Dimplex](https://www.youtube.com/Dimplex) 



QR label

For more information on the Flame Connect app, visit dimplex.com/fcapp



1-888-346-7539 | www.dimplex.com

In keeping with our policy of continuous product improvement, we reserve the right to make changes without notice.

© 2020 Glen Dimplex Americas

 A BRAND OF GLEN DIMPLEX AMERICAS