

## MONTIGO® the art of **fireplaces** DelRay Square

### INDOOR DIRECT VENT GAS FIREPLACE

DRSQ42NI  
DRSQ42LI  
DRSQ42NI-2  
DRSQ42LI-2

DRSQ46NI  
DRSQ46LI  
DRSQ46NI-2  
DRSQ46LI-2



## ⚠ CAUTION

Installation and service must be performed by a qualified installer, service agency or the gas fitter. Check local codes and read all instructions prior to installation.

**⚠ WARNING:**  
FIRE OR EXPLOSION HAZARD  
Failure to follow safety warnings exactly could result in serious injury, death, or property damage.

- Do not store or use gasoline or other flammable vapors and liquids in the vicinity of this or any other appliance.
- WHAT TO DO IF YOU SMELL GAS
  - Do not try to light any appliance.
  - Do not touch any electrical switch; do not use any phone in your building.
  - Leave the building immediately.
  - Immediately call your gas supplier from a neighbour's phone. Follow the gas supplier's instructions.
  - If you cannot reach your gas supplier, call the fire department.
- Installation and service must be performed by a qualified installer, service agency or the gas fitter.

FOR THE MOST RECENT VERSION OF THIS MANUAL PLEASE VISIT  
[WWW.MONTIGO.COM/PRODUCT-GUIDES](http://WWW.MONTIGO.COM/PRODUCT-GUIDES)

Canada

## ENERGUIDE

Look for the **EnerGuide**  
Gas Fireplace Energy  
Efficiency Rating in this brochure

*Based on CSA P.4.1-15*



## DANGER



**HOT GLASS WILL CAUSE BURNS.  
DO NOT TOUCH GLASS UNTIL  
COOLED.**

**NEVER ALLOW CHILDREN  
TO TOUCH GLASS.**

A barrier designed to reduce the risk of burns from the hot viewing glass is provided with this appliance and must be installed for the protection of children and other at-risk individuals.

## NOTICE

**Installer:** Leave this manual with the appliance. Please refer to the Montigo website for the most current version of the fireplace manual

**Consumer:** Retain this manual for future reference. Please refer to the Montigo website for the most current version of the fireplace manual

## ⚠ WARNING

Some materials used in the manufacturing process of this product can expose you to Benzene which is known in the State of California to cause cancer and birth defects or other reproductive harm. For more information go to [www.P65warnings.ca.gov](http://www.P65warnings.ca.gov)

## Safety Alert Key

### DANGER

Indicates a hazardous situation which, if not avoided, WILL result in death or serious injury or property damage.

### WARNING

Indicates a hazardous situation which, if not avoided, COULD result in death or serious injury or property damage.

### CAUTION

Indicates a hazardous situation which, if not avoided, WILL result in minor or moderate injury.

### NOTICE

Indicates practices that are important, but not related to personal injury.

## Introduction

### Congratulations on your purchase of a Montigo Fireplace.

With over 30 years of experience, Montigo is committed to providing you with a gas fireplace that is not only a beautiful addition to your space, but that is also designed and manufactured to the highest safety, reliability and engineering standards.

We strongly encourage you to read and carefully follow the instructions laid out in this Installation, Operation and Maintenance Manual and retain it for your future reference. Pay special attention to all cautions, warnings, and notices throughout this manual intended to ensure your safety.

This manual covers installation, operation and maintenance. Lighting, operation and care of this fireplace can be easily performed by the homeowner. All installation and service work should be performed by a qualified or licensed installer, plumber or gas fitter as certified by the state, province, region or governing body where the fireplace is being installed.

This installation, operation and maintenance manual is applicable to the models described in Table 1. Refer to your rating plate to verify included options.

### Warranty and Installation Information: (See Appendix B)

The Montigo warranty will be voided by, and Montigo disclaims any responsibility for, the following actions:

- Modification of the fireplace and/or components including Direct-Vent assembly or glass doors.
- Use of any component part not manufactured or approved by Montigo in combination with this Montigo fireplace system.
- Installation other than as instructed in this manual.
- Consult your local Gas Inspection Branch on installation requirements for factory-built gas fireplaces. Installation & repairs should be done by a qualified contractor.

Unit specs and efficiency									
MODEL	Natural Gas	Propane	BTU / hr	Conversion kit required	SIT Elect. Ignition	SIT Elect. Ignition BASIC	Vent size	Reduce to 4/7? (without using powervent)	P.A. 1-15 Efficiency*
DRSQ42NI	X		32,500			X	5/8	No	63.1%
DRSQ42NI-2	X		32,500		X		5/8	No	63.1%
DRSQ42LI		X	27,000	X		X	5/8	No	63%
DRSQ42LI-2		X	27,000	X	X		5/8	No	63%
DRSQ46NI	X		40,000			X	5/8	No	64.1%
DRSQ46NI-2	X		40,000		X		5/8	No	64.1%
DRSQ46LI		X	34,000	X		X	5/8	No	64.7%
DRSQ46LI-2		X	34,000	X	X		5/8	No	64.7%

Figure 1 DRSQ specifications

**This appliance may be installed in an aftermarket, permanently located, manufactured home (USA only) or mobile home, where not prohibited by local codes.**

**This appliance is only for use with the type of gas indicated on the rating plate. A conversion kit is available for the appliance.**

## ⚠ CAUTION

Young children should be carefully supervised when they are in the same room as the appliance. Toddlers, young children, and others may be susceptible to accidental contact burns. A physical barrier is recommended if there are at-risk individuals in the house. To restrict access to a fireplace or stove, install an adjustable safety gate to keep toddlers, young children, and other at-risk individuals out of the room and away from hot surfaces

## Contents

<b>Safety Alert Key</b> .....	<b>2</b>
<b>Introduction</b> .....	<b>2</b>
Section A: Before You Begin .....	4
Installation Checklist.....	4
Standard Installation Checklist .....	5
Rating Plate Sample.....	6
<b>Section 1: Dimensions</b> .....	<b>7</b>
DelRay Square 42 Dimensions .....	7
DelRay Square 46 Dimensions .....	8
<b>Section 2: Framing</b> .....	<b>9</b>
Flooring considerations.....	9
Wall framing Dimensions .....	9
Corner framing.....	9
Elevated surface temperatures .....	10
Standard installation .....	10
Vented installation.....	11
Recess installation.....	12
Example fireplace locations.....	13
Clearances .....	14
<b>Section 3: Venting</b> .....	<b>14</b>
Restrictor plate .....	15
Flue collar.....	15
<b>Section 3-3-1: Venting Layout</b> .....	<b>16</b>
DRSQ42 5/8 TOP Venting - .....	16
Wall and roof termination.....	16
DRSQ42 Rear Venting.....	17
45° Corner Installation 5"Ø".....	17
45° or less Corner Installation 5"Ø".....	17
DRSQ46 5/8 TOP Venting - .....	18
Wall and roof termination.....	18
DRSQ46 Rear Venting.....	19
45° Corner Installation 5"Ø".....	19
45° or less Corner Installation 5"Ø".....	19
<b>Section 3-2: Installing a Roof Mounted Direct Vent Termination</b> .....	<b>20</b>
Section 3-2-1: Venting Layout.....	20
<b>Section 3-3: Installing a Wall Mounted Termination</b> .....	<b>21</b>
Section 3-3-1: Converting top/rear vent .....	22
Section 3-3-2.2: Alternate Venting Components 5"Ø".....	23
Flexmaster as alternate venting.....	24
<b>Section 4: Wiring</b> .....	<b>25</b>
DRSQ (N/L) 1 Wiring Diagram.....	25
Installation of the wall switch .....	25
DRSQ (N/L) 1-2 Wiring Diagram .....	26
Installation of Electrical Supply .....	26
<b>Section 5: Installing the gas line</b> .....	<b>27</b>
Fuel Type .....	27
Gas Pressure.....	27
Section 5-3: GAS CONNECTION.....	27
Primary air adjustment.....	27
<b>Section 6: Finishing</b> .....	<b>28</b>
Finishing Around the Fireplace.....	28
DRSQ42, DRSQ46 Mantels.....	28
DRSQ42, DRSQ46 Mantels.....	28
(With vented chase or cool wall kit).....	28
Sidewall clearances.....	29
Finishing Safety Zone .....	29
Cement Board Install.....	30

1" Adjustable trim kit .....	31
<b>Remote Operation (Full load DelRay Square)</b> .....	<b>32</b>
Initializing the System for the first time.....	33
Operating the System for the first time.....	33
Temperature Indication Display.....	33
Turn On the Fireplace.....	33
Turn Off the Fireplace.....	33
Accent Light Control.....	33
Room Thermostat (Remote Control Operation).....	34
Smart Thermostat (Remote Control Operation).....	34
Disabling Thermostat .....	34
Fan Speed Control .....	34
<b>Section 8: Removing &amp; Installing the Screen / Door</b> .....	<b>35</b>
Removing the Screen .....	35
Reinstalling the Screen .....	35
Removing the door .....	35
Reinstalling the door .....	35
Airflow Bracket Installation .....	36
<b>Propane Conversion</b> .....	<b>37</b>
<b>Section 9: Installing the Accessories</b> .....	<b>39</b>
The DelRay Square Universal burner.....	39
Installing glass media .....	39
Installing the speckled stone media.....	39
Installing a contemporary scene (glass and stone).....	40
Split Oak Logset Installation .....	41
Birch Logset Installation 42 .....	42
Birch Logset Installation 46 .....	43
Driftwood Logset Installation 42 .....	44
Driftwood Logset Installation 46 .....	45
Black Reflective Glass .....	46
Brick Liner Install.....	47
<b>Section 10: Cleaning and Maintenance</b> .....	<b>49</b>
General .....	49
Cleaning.....	49
Pilot Burner Adjustment.....	49
<b>POD - Pilot on Demand</b> .....	<b>50</b>
What is POD and CPI mode? .....	50
Remote Continuous Pilot (CPI) Selection .....	50
Installing the CPI Jumper Cable .....	50
<b>DRSQ*1 BASIC Exploded Parts</b> .....	<b>51</b>
<b>DRSQ*1-2 FULL LOAD Exploded Parts</b> .....	<b>52</b>
<b>Indoor fireplace in protected outdoor applications</b> .....	<b>53</b>
See through fireplace.....	53
Notes.....	53
Single sided fireplace .....	53
<b>Appendix A: Venting Terminations</b> .....	<b>54</b>
<b>Appendix B: Warranty</b> .....	<b>55</b>
<b>Appendix B: Warranty Continued</b> .....	<b>56</b>
<b>Appendix C: Amendment</b> .....	<b>57</b>
<b>(Gas Fireplace / Equipment sold in the State of Massachusetts)</b> .....	<b>57</b>

## Section A: Before You Begin

### IMPORTANT MESSAGE: SAVE THESE INSTRUCTIONS

The DelRay fireplaces must be installed in accordance with these instructions. Carefully read all the instructions in this manual first. Consult the Local Gas Branch to determine the need for a permit prior to starting the installation. It is the responsibility of the installer to ensure this fireplace is installed in compliance with the manufacturers instructions and all applicable codes.

### NOTICE

Do not use this appliance if any part has been under water. Immediately call a qualified service technician to inspect the appliance and to replace any part of the control system and any gas control that has been under water

### NOTICE

Due to high temperatures, the appliance should be located out of traffic and away from furniture and draperies

### NOTICE

Children and adults should be alerted to the hazards of high surface temperature and should stay away to avoid burns or clothing ignition

### NOTICE

A barrier designed to reduce the risk of burns from the hot viewing glass is provided with this appliance and shall be installed for the protection of children and other at-risk individuals

**This appliance may be installed as an OEM installation in a manufactured home(USA only) or mobile home and must be installed in accordance with the manufacturers instructions and the *Manufactured Home Construction and Safety Standard, Title 24 CFR, Part 3280, in the United States, or the Standard for Installation in Mobile Homes, CAN/CSA Z240 MH, in Canada.***

**This appliance is only for use with the type(s) of gas indicated on the rating plate. A conversion kit is available for the appliance.**

## Installation Checklist

- Determine the desired install location of your fireplace.
- See Section 1, Dimensions , and refer to the Framing Section 2 for details.
- Select the location of your termination and resulting vent run.
- Should it be impossible to meet the venting requirements laid out in Section 3: Venting, please contact your Montigo dealer regarding the use of a Montigo Power Vent.
- Lay out the Vent run; calculating the required elbows and straight runs of 5"/8" flex and/or rigid pipe.
- Layout Electrical Requirements refer to Section 4: Wiring, for Details.
- Refer to Section 5: Installing the Gas Line, for details on the gas connection and access.
- Refer to local codes and guidelines for installation requirements.
- Installation and repairs should be done by a qualified contractor and must conform to:
- Installations in Canada must conform to the local codes or in the absence of local codes to the current version of Natural Gas and Propane Installation Code, CSA B149. Electrical installations must conform to the local codes or, in the absence of local codes, to the current version of Canadian Electrical Code, CSA C22.1.1
- Installations in the USA must conform to the local codes or in the absence of local codes to the current version of National Fuel Gas Code, ANSI Z223.1/NFPA 54. Electrical installations must conform to the local codes or, in the absence of local codes, to the current version of the National Electrical Code, ANSI/NFPA 70. See Appendix C for installation within the State of Massachusetts

### NOTICE

Clothing or other flammable material should not be placed on or near the appliance

### NOTICE

Installation and repair should be done by a qualified service person. The appliance should be inspected before use and at least annually by a professional service person. More frequent cleaning might be required due to excessive lint from carpeting, bedding material, etc. It is imperative that control compartments, burners, and circulating air passageways of the appliance be kept clean

## Standard Installation Checklist

This standard installation checklist is to be used by the installer in conjunction with, not instead of, the instructions contained within this installation manual.

Customer _____	Date Installed: _____
Install Address: _____	Location of Fireplace: _____
_____	Installer: _____
Model (circle one): DRSQ42NI, DRSQ42NI-2, DRSQ42LI, DRSQ42LI-2, DRSQ46NI, DRSQ46NI-2, DRSQ46LI, DRSQ46LI-2	Dealer Phone: _____
	Serial #: _____

	YES	NO	IF NO, WHY NOT?
<b>Appliance Install: Section 2</b>			
Framing complies with install manual.			
Standoffs have been installed.			
Proper clearances have been maintained.			
<b>Venting: Section 3</b>			
Venting configuration complies with vent diagrams.			
Venting installed, fastened, and secured in place maintaining proper clearance.			
Firestops installed.			
Exterior wall/roof flashing installed and sealed in compliance with local building code.			
Terminations installed and sealed in compliance with local building code.			
Direct vent termination is highest point in vent assembly.			
<b>Wiring/Electrical: Section 4</b>			
Unswitched power provided to the appliance PPO box.			
Low voltage wire connected to dry contact wall switch (non-powered)*			
<b>Gas: Section 5</b>			
Proper appliance for fuel type.			
Was a conversion performed?			
Leak check performed & inlet pressure verified.			
<b>Finishing: Section 6</b>			
Only non-combustible materials installed in non-combustible areas.			
Clearances meet installation manual requirements			
Mantels and/or projections comply with install manual			
<b>Appliance Setup: Section 7 through 9</b>			
Media, door, and screen installed according to install manual			
Manual given to home owner.			
Started appliance and verified no gas leaks exist.			
<b>Comments:</b>			



## Section 1: Dimensions

### DelRay Square 42 Dimensions

BASIC MODELS	
DRSQ42NI	DRSQ42LI

FULL LOAD MODELS	
DRSQ42NI-2	DRSQ42LI-2

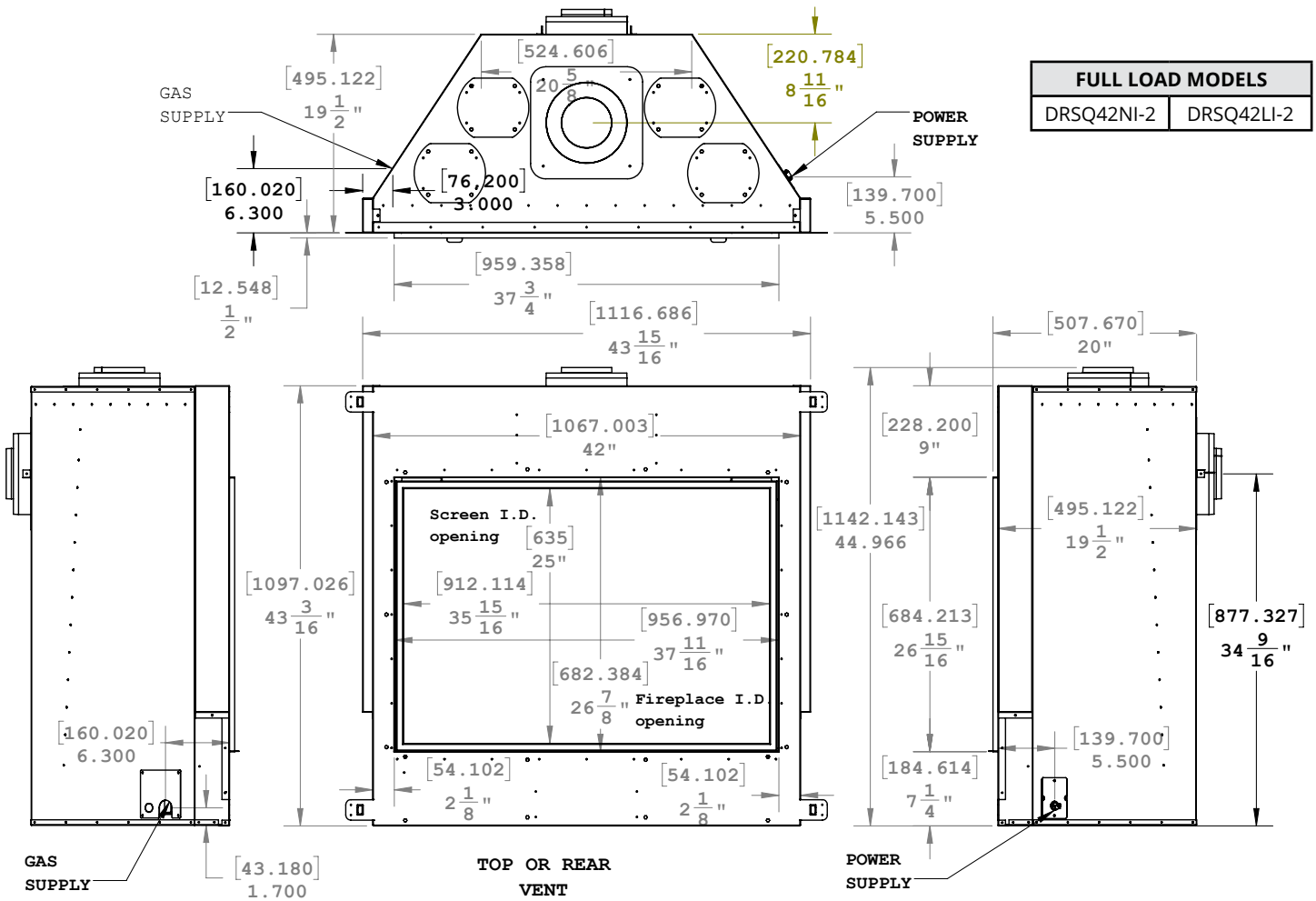



## DelRay Square 46 Dimensions

BASIC MODELS	
DRSQ46NI	DRSQ46LI

FULL LOAD MODELS	
DRSQ46NI-2	DRSQ46LI-2

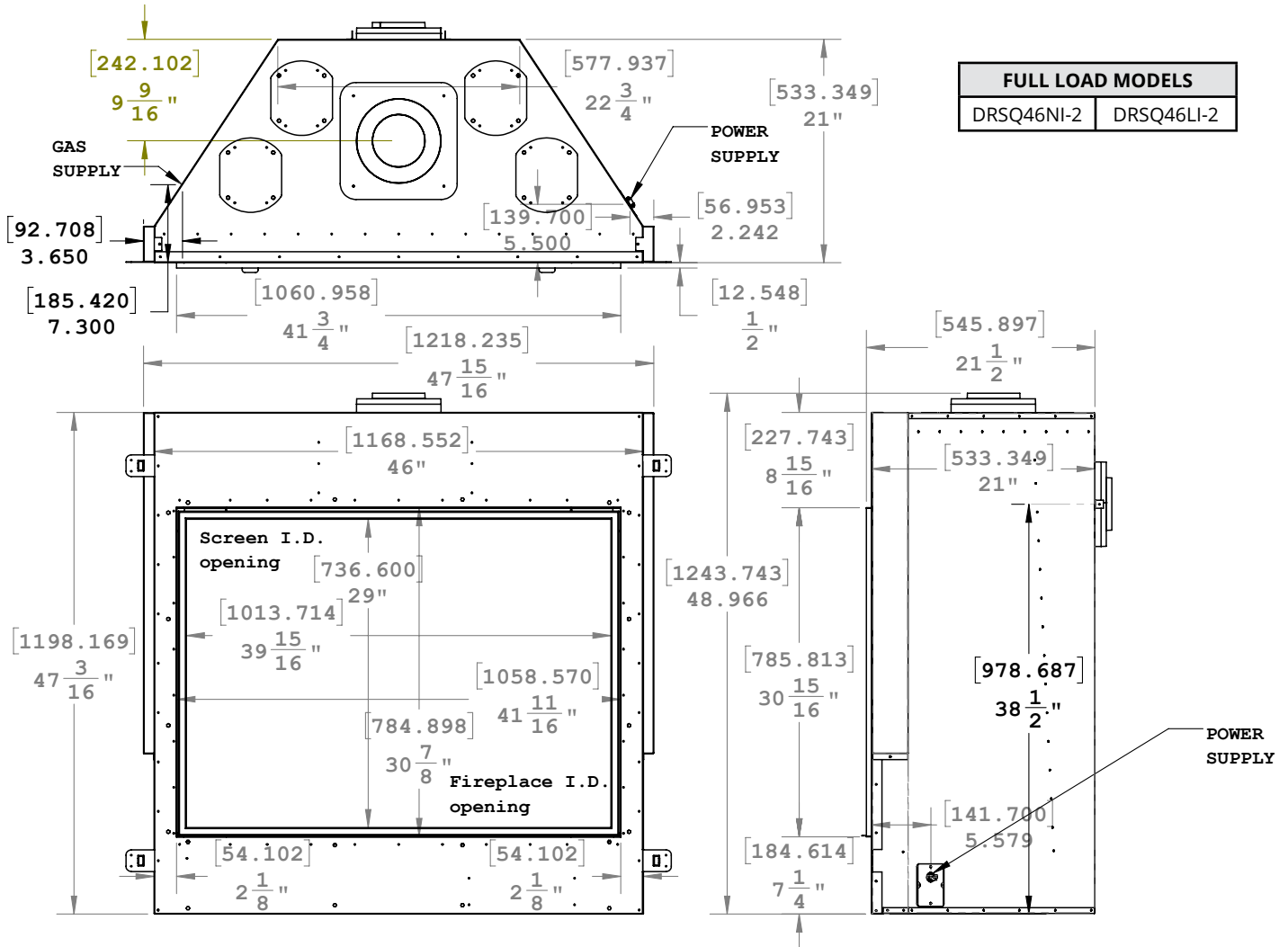



## Section 2: Framing

1). Frame in the enclosure for the unit with framing materials. The framed opening for the assembled fireplace shown below in table as the MINIMUM dimensions.

	A	B	C	D	E	F	G
DRSQ42	72"	51"	21"	45"	62 <sup>7</sup> / <sub>16</sub> "	44 <sup>1</sup> / <sub>8</sub> "	1

	A	B	C	D	E	F	G
DRSQ46	84"	55"	22"	49"	67 <sup>3</sup> / <sub>8</sub> "	47 <sup>5</sup> / <sub>8</sub> "	1

Combustible header can be reduced to 2" above unit if the fireplace chase is vented

NOTE: When constructing the framed opening, please ensure there is access to install the gas line when the unit is installed

### Wall framing Dimensions

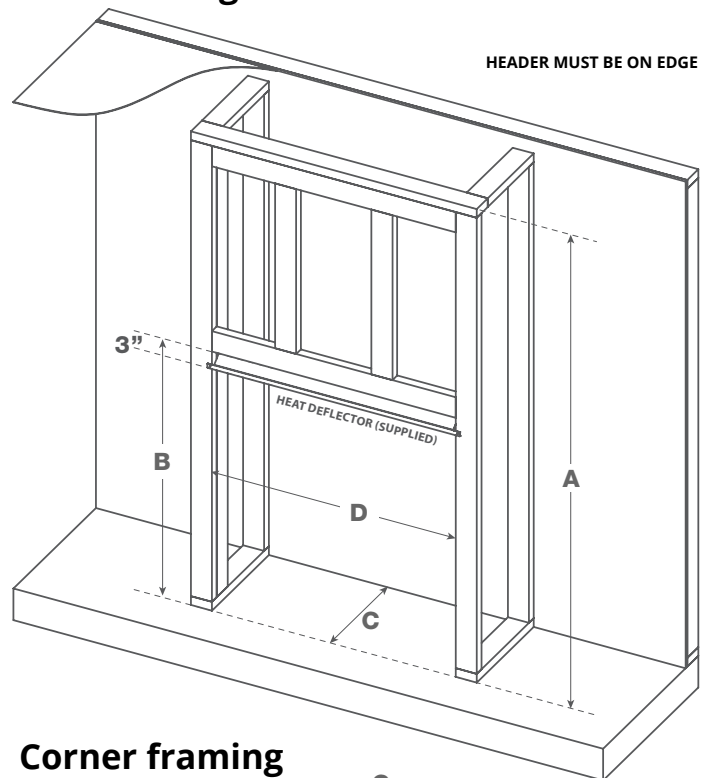

### Recommended flooring considerations

Flooring such as Luxury Vinyl Plank (LVP) and other vinyl flooring can be sensitive to radiant heat and changes in temperature. If using vinyl flooring we recommend you install the fireplace in one of the ways shown below.

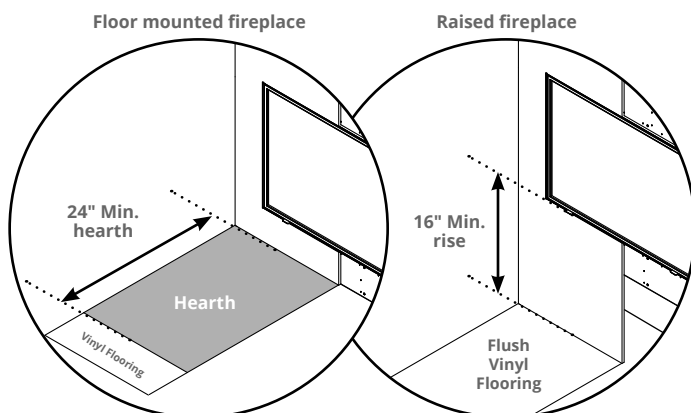

The minimum width of the hearth is equal to the width of the fireplace.

Raise the fireplace 16" above the floor to allow for vinyl flooring to be installed flush to the wall. (Measured from floor to the bottom of the door opening)

### Corner framing

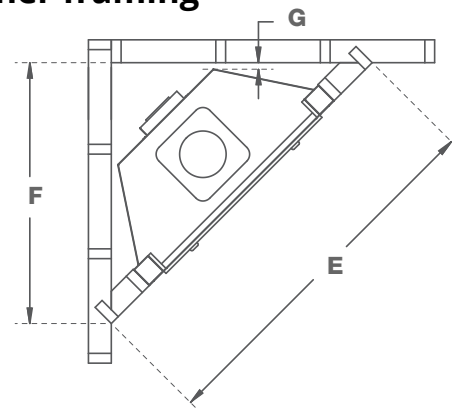

Figure 3.b Framing dimensions (Straight wall & Corner Installation).

### ⚠ WARNING

To avoid the possibility of insulation or vapour barrier coming in contact with the fireplace body, we recommended that the inner chase be finished (i.e. drywall / sheetrock). Follow local codes for requirements in your area.

## Elevated surface temperatures

The below are surface temperatures of the area above the fireplace opening after a 3 hour burn period. Use this guide in good faith to decide on an appropriate facing material and mantle. A cool wall kit can aid in lowering surface temperatures as shown.

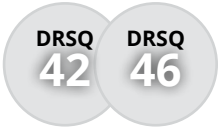

## Standard installation

**NO RECESS**

**NON-COMBUSTIBLE FACING**

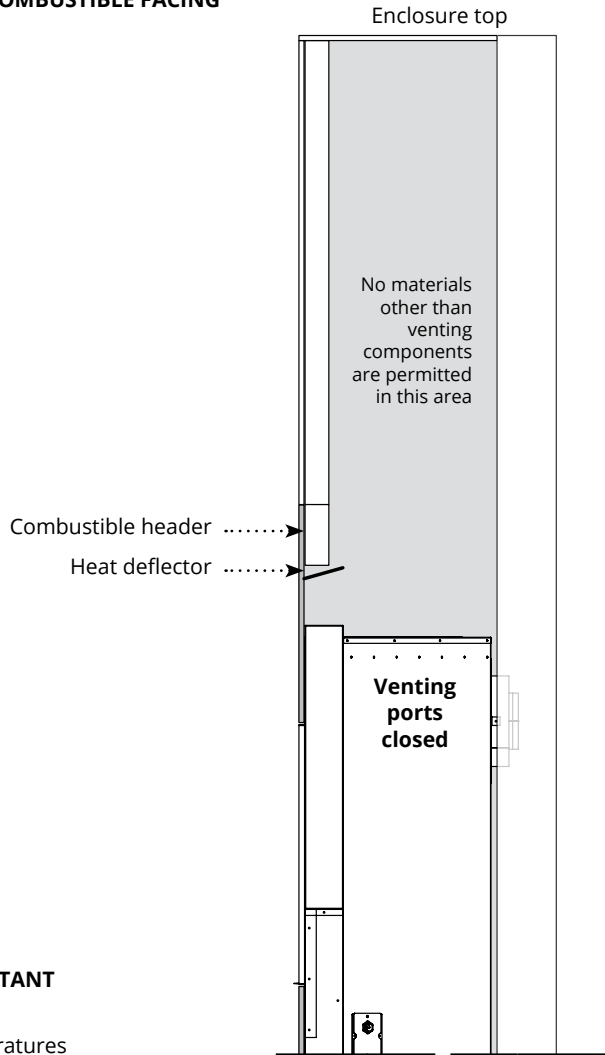

### IMPORTANT

Temperatures are based off of the minimum enclosure size.

DRSQ42 Temp. above opening		DRSQ46 Temp. above opening	
16"	150°F	16"	160°F
12"	170°F	12"	180°F
8"	210°F	8"	210°F
4"	240°F	4"	230°F

**⚠ WARNING**

Combustible facing material not allowed with standard minimum chase

## Vented installation

**NO RECESS**

**COMBUSTIBLE FACING**

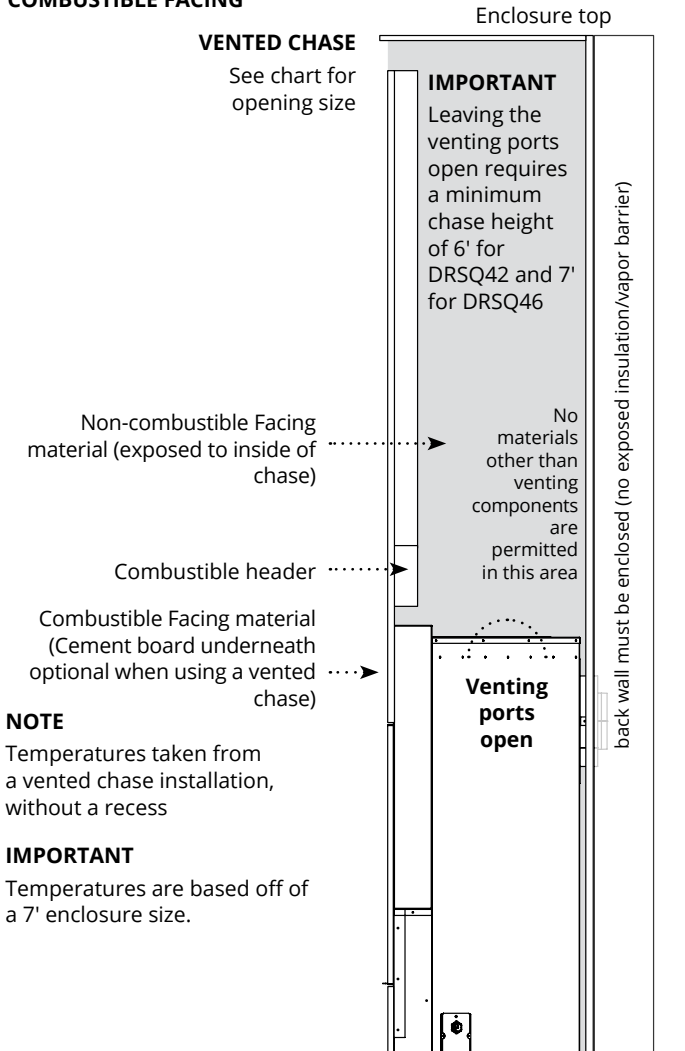

DRSQ42 Temp. above opening		DRSQ46 Temp. above opening		DRSQ42 Min. chase opening	DRSQ46 Min. chase opening
16"	100°F	16"	110°F	120sq inch	140sq inch
12"	110°F	12"	120°F		
8"	130°F	8"	140°F		
4"	140°F	4"	150°F		

### **WARNING**

Vented installations require that the chase inner wall must be enclosed (no exposed insulation/vapour barrier) Follow local codes

## Recess installation

TV RECESS (REAR VENT RECOMMENDED)  
COMBUSTIBLE FACING

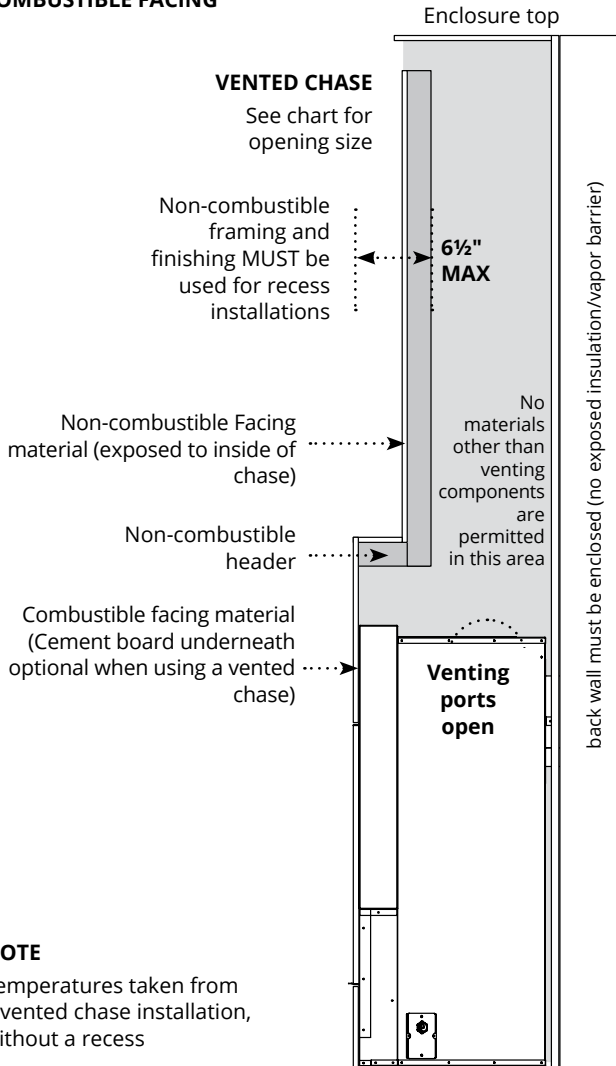

**NOTE**  
Temperatures taken from a vented chase installation, without a recess

DRSQ42 Temp. above opening		DRSQ46 Temp. above opening	
16"	100°F	16"	110°F
12"	110°F	12"	120°F
8"	130°F	8"	140°F
4"	140°F	4"	150°F
DRSQ42 Min. chase opening		DRSQ46 Min. chase opening	
120sq inch		140sq inch	

**IMPORTANT**  
Leaving the venting ports open requires a minimum chase height of 6' for DRSQ42 and 7' for DRSQ46

**⚠ WARNING**

Vented chase opening is mandatory when you open fireplace vent ports (all ports must be open).

Venting ports (shown on a DRSQ46)

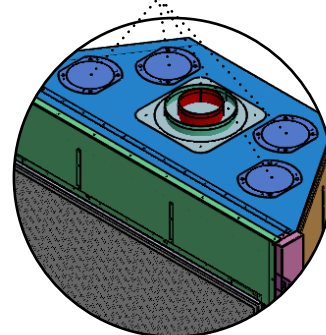

## Example fireplace locations

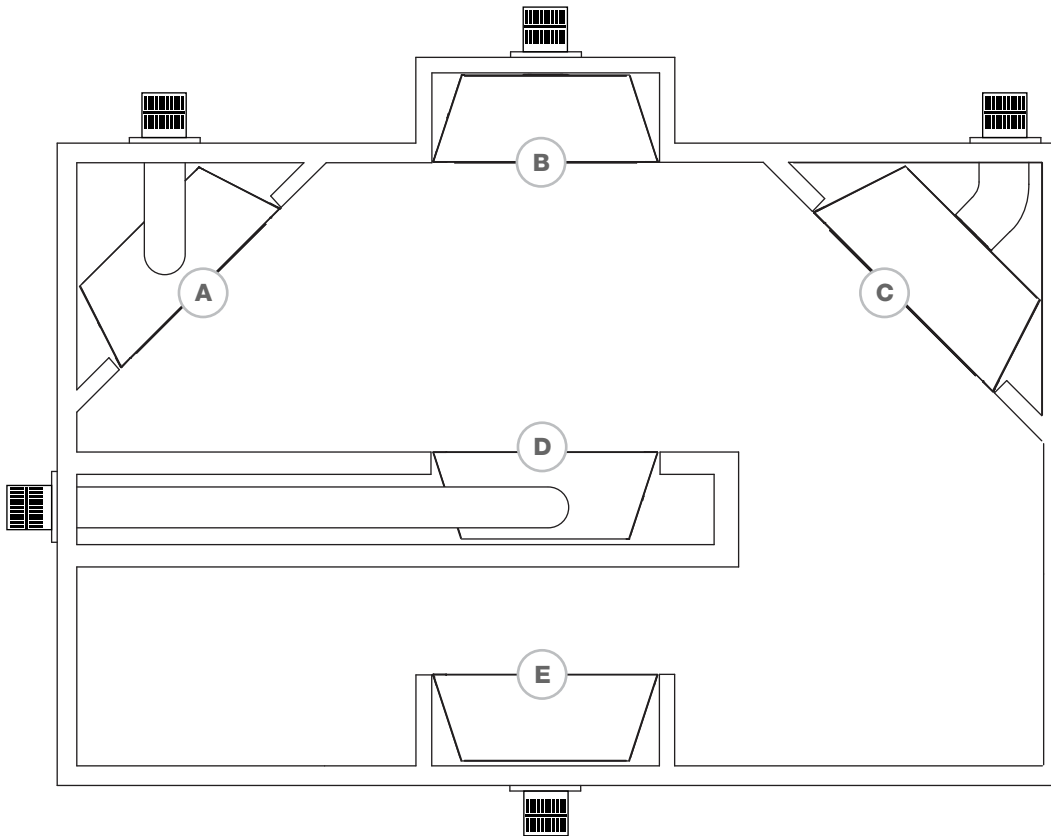

### NOTICE

This figure is to show typical installations and is for design purposes only. The figure is not drawn to scale and installations may vary due to individual design preference and local codes. Refer to the venting and clearances section for additional requirements

Install locations	
A	Corner - Up-and-out (top vented)
B	Exterior wall
C	Corner - Rear vented
D	Island
E	Rear vented

## Section 3: Venting

### Clearances

When installing a shelf over the top of the fireplaces, the following guidelines must be adhered to:

MODEL	Top - Top vent †	Top - Rear vent †	Rear	Sides	Floor	Mantel	Vent Pipe
DRSQ42*1	28"	28"	1½"	½"	0"	10"	1" all around 2" on the horizontal
DRSQ42*1-2	28"	28"	1½"	½"	0"	10"	1" all around 2" on the horizontal
DRSQ46*1	35"	35"	1"	½"	0"	10"	1" all around 2" on the horizontal
DRSQ46*1-2	35"	35"	1"	½"	0"	10"	1" all around 2" on the horizontal

Figure 4. Combustible Wall Clearances

#### NOTES:

† Clearance from top of fireplace to a ceiling within the fireplace enclosure.

### WARNING

When this appliance is installed directly on ANY combustible other than wood flooring (carpet, vinyl, etc.). It must be installed on an equivalent wood or metal panel. This material must extend the full width and depth of the appliance.

### NOTICE

Clearances must be in accordance with local installation codes and the requirements of the gas supplier

Montigo offers a variety of direct venting and termination options. The direct vent termination location **MUST** be selected such that it is the highest point in the venting assembly. It should also be selected such that it provides the shortest vent run possible. Should it be impossible to ensure that the termination is the highest point or to meet the venting guidelines laid out below please contact your Montigo dealer to discuss power venting options.

#### Notes For Planning Venting:

- Venting originates from the top or rear of the unit
- Venting can terminate through the roof or through an exterior wall.
- Refer to Appendix A - Termination Locations to ensure the planned termination location is acceptable.
- Once the termination location has been established, refer to the appropriate section below for installation details
- All fireplaces shipped from the factory are top vent.
- **Silicone** application is **NOT** required when joining Montigo vent pipes and components.



### NOTICE

Under no circumstances can Montigo flex venting be cut to accommodate an installation. Use an alternative length to complete your vent run. (Excluding flex included in the PVK05, MVK05)

#### PVK05 (5/8), PVK05F (5/8), MVK05 (4/7), MVK05F (4/7)

PVK05 / MVK05 Flex Vent Kit is a standalone 5 ft. vent kit that cannot be combined with Montigo Flex or Montigo Rigid pipe to extend beyond the 5ft of flex included in this kit. The Flex in this kit can be cut down if shortening is required. Any other venting configuration beyond the 5ft included in the kit will require going to either Montigo Rigid pipe or Montigo Flex pipe referenced in the manual pages Venting section.

**PVK05** Includes RHS101 heat shield, 5' flex pipe (with spacers), and PTO4 termination  
**PVK05F (WITH TERM. FRAME)** Includes RHS101 heat shield, 5' flex pipe (with spacers), and PTO4F termination

**MVK05** Includes RHS101 heat shield, 5' flex pipe (with spacers), and MTO4 termination

**MVK05F (WITH TERM. FRAME)** Includes RHS100 heat shield, 5' flex pipe (with spacers), and MTO4F termination

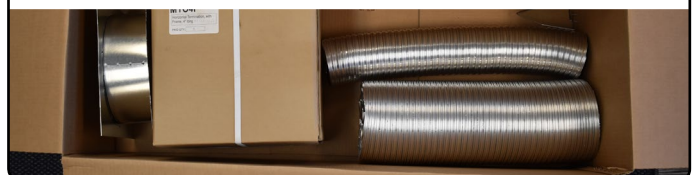

Figure 4.a PVK05F Flex Vent Kit shown

## Restrictor plate

The fireplace is equipped with a factory installed restrictor set at fully open. If fireplace vent is terminated horizontally, NEVER CLOSE the restrictor completely. Adjust the restrictor opening by judging flame characteristics after 20 minutes of burn time (on cold start, for first few minutes the flames might be blue).

If flames ghost off the burners or if sooting occurs (mostly with propane) open the restrictor fully and work backwards in increments to determine the correct position.

FOR REAR VENT RESTRICTOR MUST BE LEFT FULL OPEN.

FOR POWER VENTED UNITS RESTRICTOR MUST BE CLOSED.

For most runs that include lengths of both horizontal and vertical pipe, especially ones with multiple elbows or long horizontal runs, restrictor should be full open.

Restrictor opening should be adjusted for long vertical lengths with short horizontal runs or vertical only runs to reduce flue draft.

**Recommended** settings for vertical runs (depends on installation specifics, altitude, fuel and other factors):

- For Verticals 3' to 6' - various between fully open to 1" open
- For Verticals 7' to 10' - 1" open or fully closed
- For Verticals over 10' - fully closed

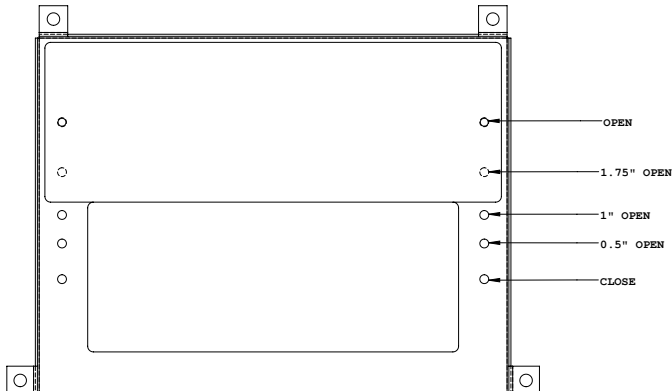

## Flue collar

The unit ships with the both 5" and 8" collars inverted, these must be removed, flipped, and attached to the fireplace with the included 1/2" quad screws.

- 1 Remove the 8" collar cover. (attached with 1/2" Tek screws)

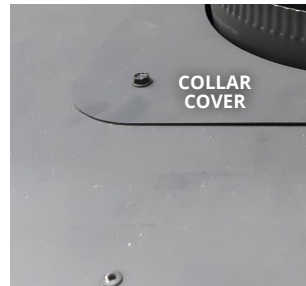

- 2 Remove the 8" collar



- 3 Remove the 5" collar



- 4 Flip and attach both collars with the included hardware (1/2" quad screws), reattach collar cover



## Section 3-3-1: Venting Layout

### DRSQ42 5/8 TOP Venting - Wall and roof termination

Maximum total vent run allowed is 34 ft. (V+H ≤ 34ft.)

For longer vent runs, a power vent is required

V + H are measured from the center of vent elbows  
Elbow may be attached directly to the top of the unit.

Maximum vertical run allowed is 32 ft. (V max).

Maximum horizontal run allowed is 25 ft. (H max).

#### Elbows:

Two 45° elbows = 90° elbow

Each elbow reduces vent run by 3'

Max elbows = 4

## NOTICE

Converting to 4/7 is **NOT** permissible for the DRSQ42 except when using a power vent

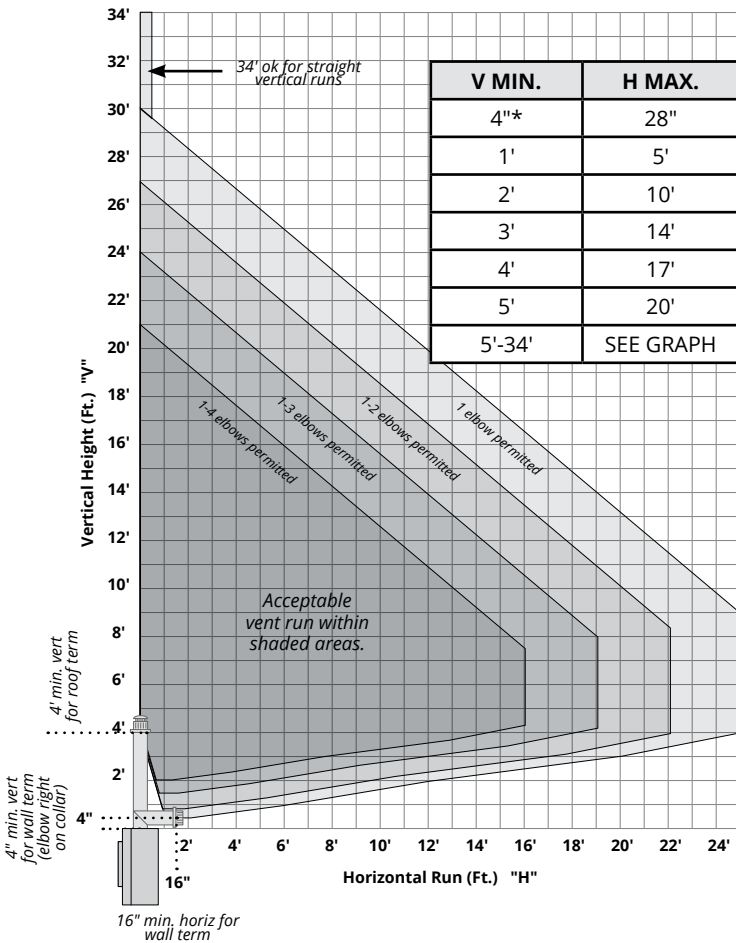

\*4" vertical minimum is based on the vent center of an elbow mounted directly on the top of the unit.



## DRSQ42 Rear Venting

A maximum 18" of horizontal run is allowed on rear vented applications, though the addition of a 45° elbow is permitted for corner installations.

**REAR VENTING NOT PERMITTED FOR 4/7 VENTING.**

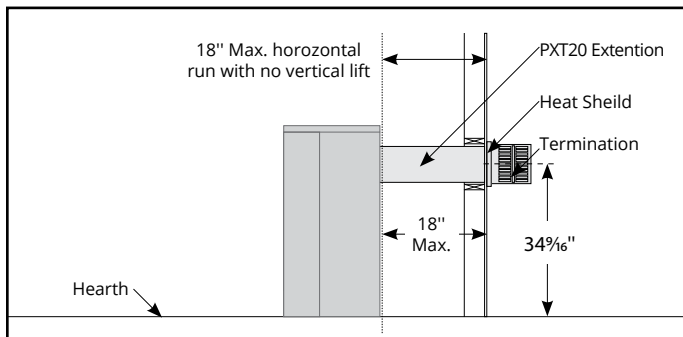
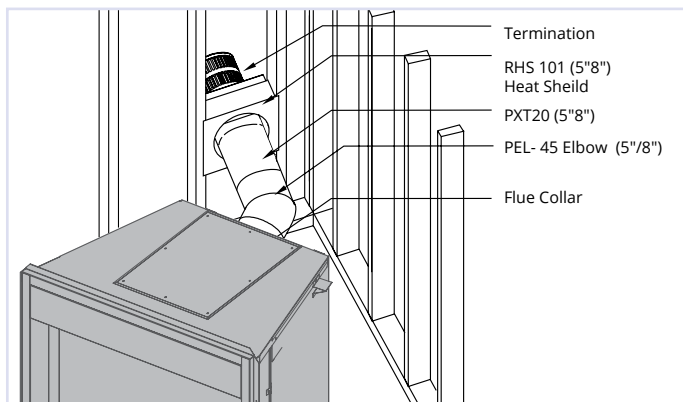

Figure 9.b Straight run, Rear Vented, wall mounted termination.

## 45° Corner Installation 5"/8"

Attach an EEL-45 (45° elbow) directly onto the flue collar and attach it to the MXT-20, cut the MXT-20 to suit. Slide the fireplace into position and attach to the termination.



## 45° or less Corner Installation 5"/8"

Use an PTO-4 termination and an PFL-1 or PFL-2/PFL-2 (12" or 24" compressed length) and a frame, if appropriate. Flex may be turned to obtain desired degree of angle required but must not exceed 45°.

**PVK05 kit can be also be used**

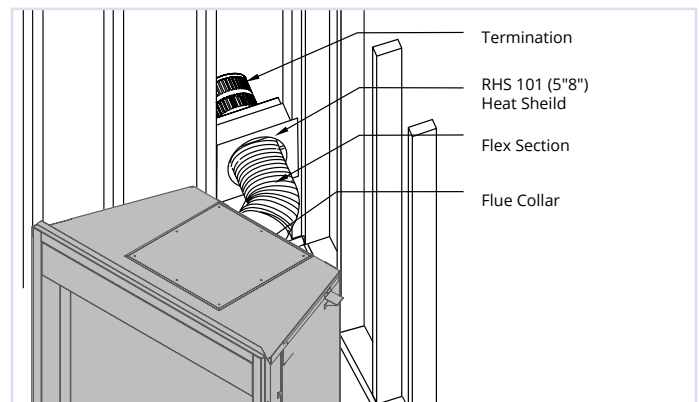

## NOTICE

Corner Installation is available for **NATURAL GAS UNITS ONLY**

**NOTE:** The PVK05 / PVK05F kit is available for top vent corner FLEX application (NG only). The Kit includes a heat shield, flex pipe, and a termination with or without a mounting frame.

## NOTICE

Converting to 4/7 is **NOT** permissible for the DRSQ46 except when using a power vent

DRSQ  
46

### DRSQ46 5/8 TOP Venting - Wall and roof termination

Maximum total vent run allowed is 34 ft. (V+H ≤ 34ft.)

For longer vent runs, a power vent is required

V + H are measured from the center of vent elbows

Elbow may be attached directly to the top of the unit.

Maximum vertical run allowed is 32 ft. (V max).

Maximum horizontal run allowed is 25 ft. (H max).

#### Elbows:

Two 45° elbows = 90° elbow

Each elbow reduces vent run by 3'

Max elbows = 4

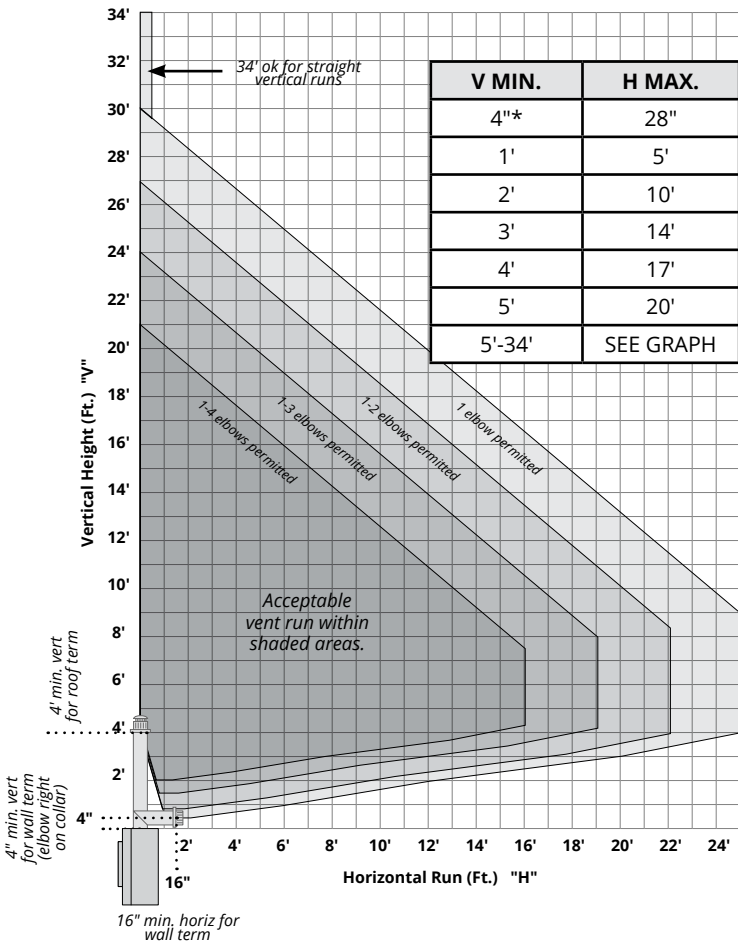

\*4" vertical minimum is based on the vent center of an elbow mounted directly on the top of the unit.

## DRSQ46 Rear Venting

A maximum 18" of horizontal run is allowed on rear vented applications, though the addition of a 45° elbow is permitted for corner installations.

**REAR VENTING NOT PERMITTED FOR 4/7 VENTING.**

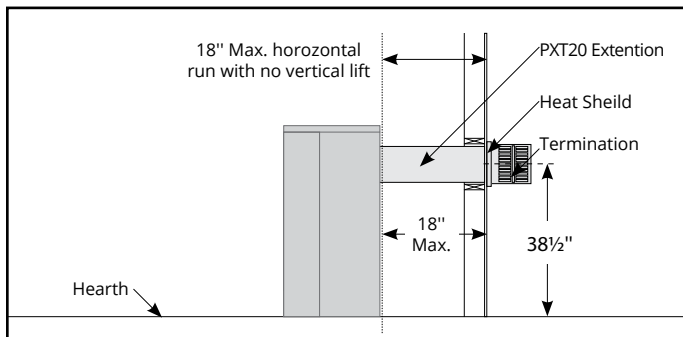
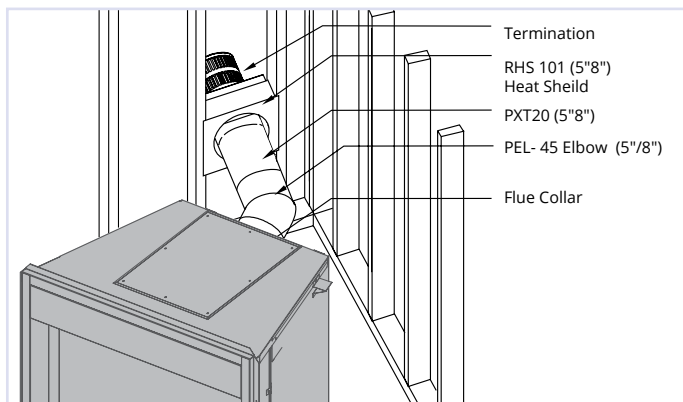

Figure 9.b Straight run, Rear Vented, wall mounted termination.

## 45° Corner Installation 5"/8"

Attach an EEL-45 (45° elbow) directly onto the flue collar and attach it to the MXT-20, cut the MXT-20 to suit. Slide the fireplace into position and attach to the termination.



## 45° or less Corner Installation 5"/8"

Use an PTO-4 termination and an PFL-1 or PFL-2/PFL-2 (12" or 24" compressed length) and a frame, if appropriate. Flex may be turned to obtain desired degree of angle required but must not exceed 45°.

**PVK05 kit can be also be used**

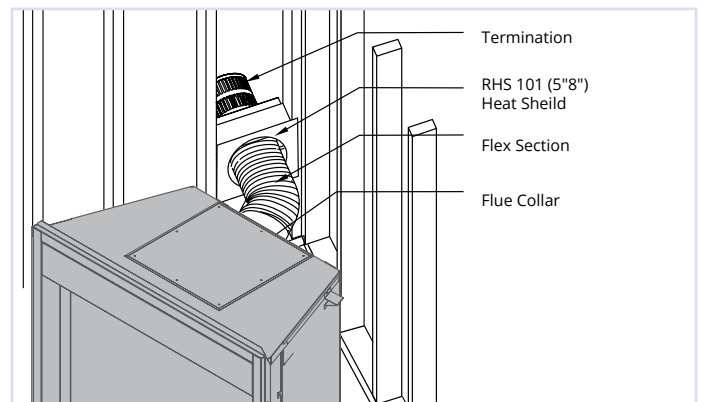

## NOTICE

Corner Installation is available for **NATURAL GAS UNITS ONLY**

**NOTE:** The PVK05 / PVK05F kit is available for top vent corner FLEX application (NG only). The Kit includes a heat shield, flex pipe, and a termination with or without a mounting frame.

## Section 3-2: Installing a Roof Mounted Direct Vent Termination

This section applies to installations where the direct vent termination will be roof mounted.

### Section 3-2-1: Venting Layout

Selection of components and details of venting lay out should adhere to the following guidelines:

- The maximum termination point is 34' above the fireplace (NOTE: if the maximum termination height is used, the flame pattern may be affected).
- The Vertical termination must be a minimum 2' higher than where the termination exits the roofing materials, (asphalt shingles, cedar shakes, etc). This distance should be measured from the high side of the roof slope where the flue flashing intersects the roofing materials.
- See Appendix A for termination locations.
- For a more detailed diagram of allowed termination locations, see Appendix A.
- A maximum of two offsets (each offset is made up of 2-90° bends) may be made for vertical vent runs.
- Firestops must be installed as required by National & local codes.
- Ensure all horizontal runs are supported with a minimum of 3 supports per 10' of venting.
- Install all roof flashing and storm collars as shown.

### Roof mounted terminations

The following details are some possible configurations for roof mounted terminations. See below.

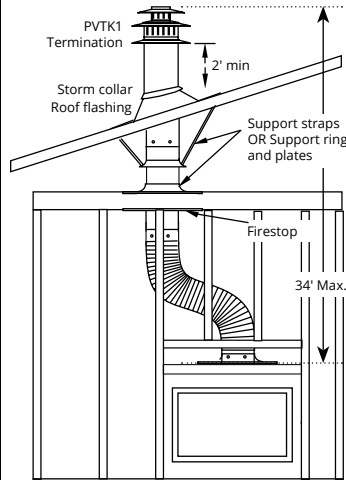

**Figure 6.b** Top vent, Roof mounted with 1 offset (1 offset= two 90° bends).

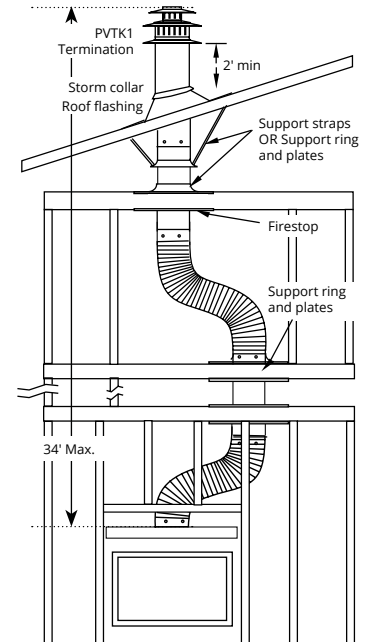

**Figure 6.c** Top vent, Roof mounted with 2 offsets (1 offset= two 90° bends).

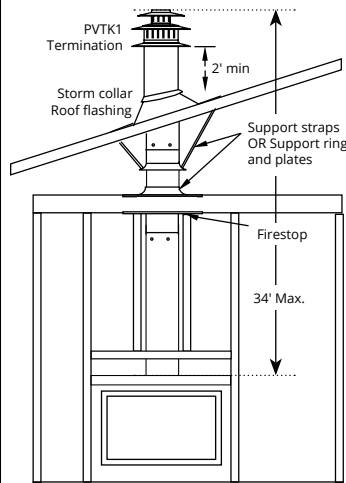

**Figure 6.** Top vent, roof mounted termination with no offset in vent run.

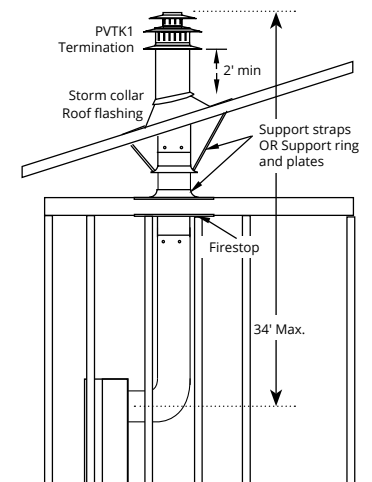

**Figure 6.d** Side vent, Roof mounted venting (1 = 90° bend).

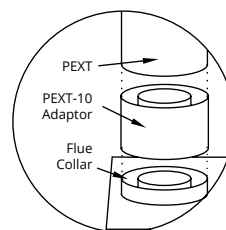

## Section 3-3: Installing a Wall Mounted Termination

This section applies to installations where the direct vent termination will be wall mounted. **NOTE:** If subject to a highly corrosive environment i.e. Seaside, Montigo recommends using Stainless Steel Termination.

### Installation of termination with built in frame

A termination with a built-in frame is installed during framing of a structure.

1. Frame the termination opening to 11" x 11".
2. Install exterior sheathing to the structure framing.
3. Fasten the termination to the sheathing using a minimum of 4 screws.

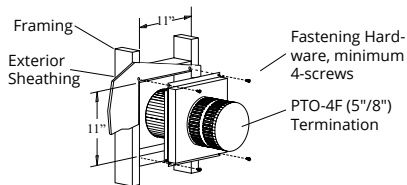

Figure 7. Installing a PTO4-F, MTO4-F termination.

### Installation of termination frame at time of framing

Terminations with a MSR frame allow the installation of the frame prior to installation of the termination.

1. Frame the termination opening to 12" x 12".
2. Secure the MSR Frame to the exterior sheathing of the structure.
3. Fasten the termination to the MSR Frame using a minimum of 4 screws.

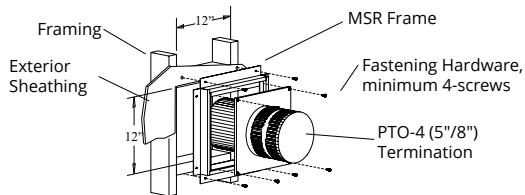

Figure 7.b Installing a MTO, PTO termination with the MSR frame.

### Installation of termination frame at time of framing in masonry

Terminations with a BSR frame allow the installation of the frame in masonry prior to the installation of the termination

1. Frame the BSR opening to 12" x 12".
2. Secure the BSR Frame to the exterior sheathing of the structure.
3. Fasten the termination to the BSR Frame using a minimum of 4 screws.

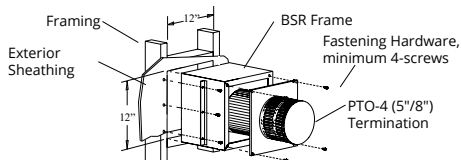

Figure 7.c Installing a MTO, PTO termination with the BSR frame.

### Installation of termination from inside structure

A Termination with a MOSR Frame is installed from the inside of the structure. These are commonly used in high-rise construction.

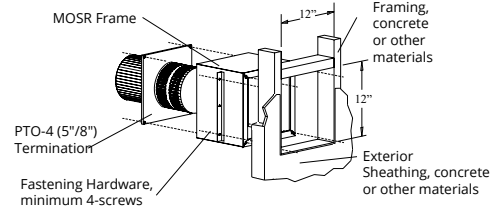

Figure 7.d Installing a PTO termination with MOSR frame.

1. Frame the MOSR opening to 12" x 12".
2. Fasten the MOSR frame to the interior side of the studs, concrete, or finished wall construction using a minimum of 4 screws.
3. Insert the termination into the MOSR frame as shown here, (from the inside) and attach to the MOSR by installing a min. quantity of 4 bolts into the threaded nuts on the MOSR Frame.

### Installation of a termination shield for vinyl siding

The VSS Termination shield is installed when the exterior of a structure is clad with Vinyl siding. It is placed directly above, and on-center with the termination.

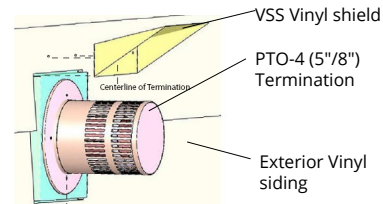

Figure 7.e Installing the VSS Vinyl Shield.

### Installing heat guards

Installing heat guards over terminations is recommended in installations where the termination is located within 7' feet above grade, or above a pedestrian walkway, and may be required by code in public areas.

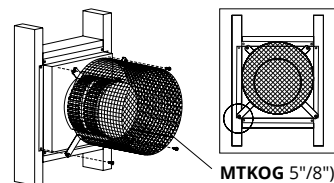

Figure 7.f Installing a MTO, PTO termination heat guard.

1. Ensure that the two long mounting brackets are facing the bottom of the termination (See inset). This will provide more heat protection at the top of the termination, where temperatures are highest.
2. Attach to the faceplate of the termination using four sheet metal screws.

Montigo supplies a variety of direct venting and termination options. The direct vent termination location **MUST** be selected such that it is the highest point in the venting assembly. It should also be selected such that it provides the shortest vent run possible. Should it be impossible to ensure that the termination is the highest point or to meet the venting guidelines laid out below please contact your Montigo dealer to discuss power venting options.

### Notes For Planning Venting:

- Venting can originate from the unit through the top or through the rear
- Venting can terminate through the roof or through an exterior wall.
- Refer to Appendix A - Termination Locations to ensure the planned termination location is acceptable.
- Once the termination location has been established, refer to the appropriate section below for installation details
- All fireplaces shipped from the factory are top vent.
- **Silicone** application is **NOT** required when joining Montigo vent pipes and components.

## Section 3-1: Converting top/rear vent

- Remove the collar cover on the top of the unit, also remove the full collar cover from the rear of the unit.
- The 2 collars can be now be unscrewed from the top of the unit. (Note that certain models are not fastened during shipping, hardware can be found taped to the flue collar.)
- The 2 blanking disks are now removed from the rear of the unit and placed in their respective positions on the top of the unit with the included quad screws.
- The vent collars are now secured to the rear of the unit with the included hardware, finish by attaching the collar cover.

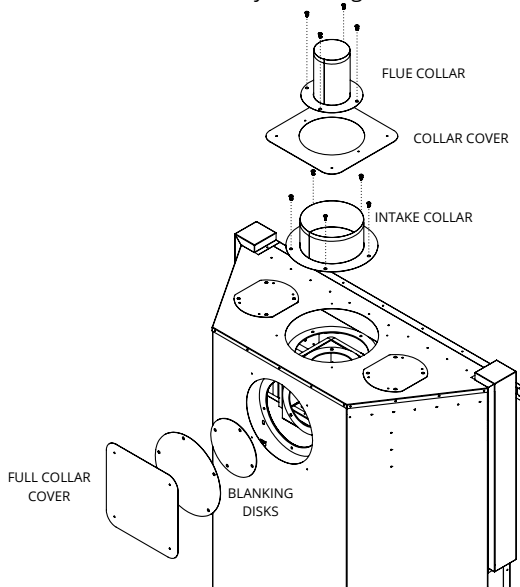

Figure 7. Flue cover and collar removal and install, Top Vented fireplace.

### Connection and installation of the vent components should adhere to the following guidelines:

- Use any combination of rigid and flex pipe as required and in any orientation (Male connectors can face in any direction).
- Flex sections may be stretched up to 50% of their total length (e.g. a 24" section may be stretched to 36").
- Connect all vent sections using a minimum of three sheet metal screws on the outer pipe, add three additional screws on the inner pipe when using flex vent.
- Ensure the pipe ends male to female slide in a minimum of 1 1/2" of overlap.
- Ensure all horizontal runs are supported with a minimum of 3 supports per 10' of venting.
- When hanging/supporting venting, ensure that 1" clearance is maintained on sides and bottom of vent runs and 2" above horizontal vent runs to any combustible material.
- Rigid pipe may be cut less than half way from the **FEMALE END ONLY**.
- Ensure when cutting sections of rigid pipe to maintain integrity of internal supports.
- Flex pipe cannot be cut
- Place the springs, supplied with the pipe kit (flex only), between the outer and inner pipes to keep the pipes separate and avoid any possible hot spots.
- Montigo recommends the use of a flex section for the first section of venting connected directly to the fireplace, offering greater flexibility of installation and absorption of movement.
- Firestops must be installed as required by national & local codes.
- Montigo recommends that all exterior corners and joints be sealed with exterior caulking. However, we encourage you to consult your Building Envelope Engineer or Waterproofing Consultant for further recommendations.

### IMPORTANT:

Please refer to your Building Envelope Engineer or Waterproofing Consultant for a review of ALL penetrations through exterior walls or the roof.

## Section 3-3-2.2: Alternate Venting Components 5"/8"

## Installation

The following components are approved for use with Montigo products. Please contact your local Montigo dealer for further information.

Component	Montigo P/N	DuraVent P/N	ICC P/N	MetalFab P/N	Selkirk P/N	Flexmaster P/N
<b>NOTES</b>		DuraVent adaptor is designed for collared vent components, DuraVent raw flex is true 5/8				
<b>Termination</b>	PTO4 (3" Length) PTO4F (3" Length) PVTK1SS (5/8 Vent)	58DVA-HC (Horiz. 5/8 vent) 58DVA-VCH (Vert.5/8 Vent)				
<b>Rigid Sections (5/8 Vent)</b>	PEXT - 1 (12" f/m)  PEXT - 2 (24" f/m) PEXT - 3 (36" f/m) PEXT - 4 (48" f/m)  PEXT - 6 (72" f/m)	58DVA-06 (6") 58DVA-09 (9") 58DVA-12 (12") 58DVA-18 (18") 58DVA-24 (24") 58DVA-36 (36") 58DVA-48 (48") 58DVA-60 (60")	5DL6 (6") 5DL9 (9") 5DL1 (12")  5DL2 (24") 5DL3 (36") 5DL4 (48")	5D6 (6")  5D12 (12") 5D18 (18") 5D24 (24") 5D36 (36") 5D48 (48")	5DT-06 5DT-09 5DT-12 5DT-18 5DT-24 5DT-36 5DT-48	5DVKIT58X01 5DVKIT58X01.5 5DVKIT58X02 5DVKIT58X03 5DVKIT58X04 5DVKIT58X06
<b>Flex Sections (with collar)</b>	PFL1 (12" flex pipe) PFL18 (18" flex pipe) PFL2 (24" flex pipe) PFL3 (36" flex pipe) PFL4 (48" flex pipe) PFL6 (72" flex pipe)	58DVA-36FF (36" F/F Section) 58DVA-60FF (60" F/F Section)  58DVA-120FF (120" F/F Section)				
<b>Flex Sections (Raw, no collar)</b> DuraVent adaptor 58DVA-AD-M1 not required when using raw flex		58DVA-36FO (36" Section) 58DVA-60FO (60" Section)  58DVA-120FO (120" Section)				4DVKIT58X01 4DVKIT58X01.5 4DVKIT58X02 4DVKIT58X03 4DVKIT58X04 4DVKIT58X06
<b>Rigid Pipe Extension</b>	PXT12 (12" f/f) PXT20 (20" f/f)	58DVA-08A (12") 58DVA-16A (20")	5DLT (12") 5DLS1 (12") 5DLT2 (20") 5DSL2 (20")	5DAL (3" to 10")	5DT-AJ12 (12")	
<b>Rigid Telescopic Pipe</b>		58DVA-17TA 58DVA-24TA	5DLA30			
<b>Elbows (5/8 Vent)</b>	PEL-90MM (m/m 90°) PEL-90FF ( f/f 90°) PEL-90FM ( f/m 90°) PEL-45FM ( f/m 45°)	58DVA-E30 (30°) 58DVA-E45 (45°) 58DVA-E60 (60°) 58DVA-E90 (90°)	5DE45 (45°)  5DE90 (90°)	5D45L (45°)  5D90L (90°)	5DT-EL45 (45°)  5DT-EL90 (90°)	
<b>Support Ring &amp; Plate</b>	PSPXT-8	58DVA-DC	5CS		5DT-CS	
<b>Firestop</b>	FS-8	58DVA-WFS 58DVA-FS	5CS	5DFS	5DT-FS	
<b>Roof Flashing</b>	PRF-7 (1/12 - 7/12 pt.) PRF-12 (7/12 - 12/12 pt.)	58DVA-FF (flat roof) 58DVA-F6 (0/12 - 6/12 pt.) 58DVA-F12 (7/12 - 12/12 pt.)		5DF (1/12 - 7/12 pt.) 5DF-12 (8/12 - 12/12 pt.)	5DT-AF6 5DT-AF12	
<b>Metal/Tile Roof Flashing</b>		58DVA-F6DS (0/12-6/12 pt.) 58DVA-F12DS (7/12-12/12 pt.)				
<b>Heat Shield</b>	RHS101	58DVA-WTU 58DVA-WT	5WT 5WTE		5DT-WT	2DVWTE58
<b>Attic Radiation Shield</b>		58DVA-IS	5AS 5RDS		5DT-AIS	
<b>Vinyl Siding Heat Shield</b>	VSS VSSSS	58DVA-VSK (Vinyl Siding Standoff)				
<b>Wall Support</b>		58DVA-WS	5WS	5DWS	5DTWSB	
<b>Offset Support</b>		58DVA-ES	5OS		5DT-OS	
<b>Vaulted Ceiling Support</b>		58DVA-CS	5SS	5DRS	5DT-CCS	
<b>Storm Collar</b>	SC8	58DVA-SC	5SC 5SQSC	5DSC	5DT-SC	
<b>Montigo Fireplace Adapter</b>		58DVA-AD-M1	TM-5AA6	5DNA		
<b>Montigo Termination Adapter</b>		58DVA-AD-M2	TM-5TA1	5DMTA		

## Flexmaster as alternate venting

Flexmaster flex venting is approved on all Montigo residential fireplaces. Flexmaster Flex pipe may be used in any length as long as the respective vent graph provided in the manual is adhered to. This approval on Flexmaster Flex includes all and any prepackaged vent kits by Montigo containing Flexmaster venting. All Montigo prepackaged vent kits may be used on any Montigo residential unit fireplace. When using a Power vent you must use Montigo pipe only.

### HORIZONTAL FLEX RUN REQUIREMENTS:

Follow venting graph for each model as required. Support horizontal sections every 2ft to prevent sagging, allow for a ¼" rise per foot of horizontal. Use high temperature silicone and three (3) screws at fireplace collar and termination collars. Reduce horizontal run by 36" for each 90° offset after the first one.

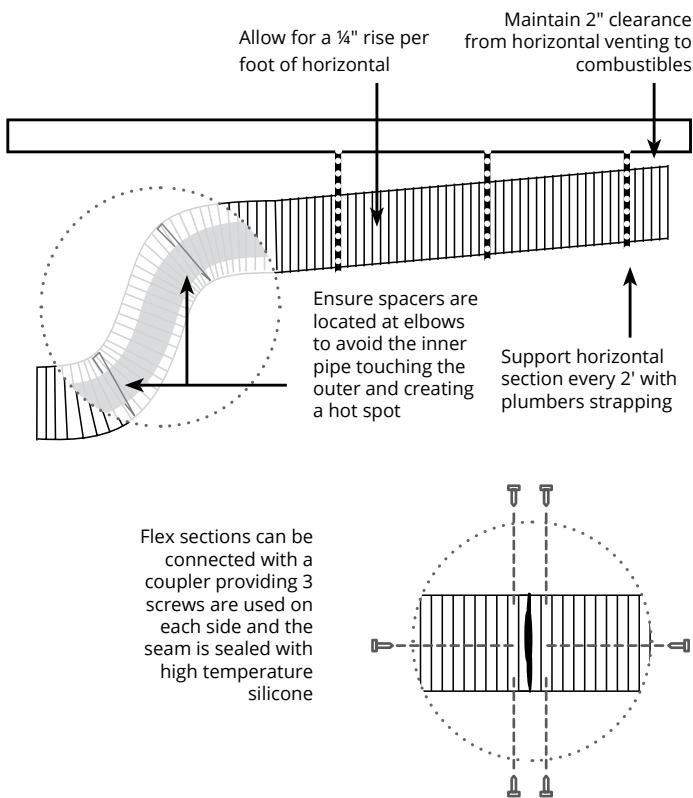

### VERTICAL THROUGH THE ROOF:

Follow venting graph for each model as required. Use mil pack and three (3) screws at joints, support horizontal section every 2 ft, use one half of RHS100 as a firestop when passing through floors and ceilings, use additional firestops as necessary to keep construction debris and insulation away from contact with vent.

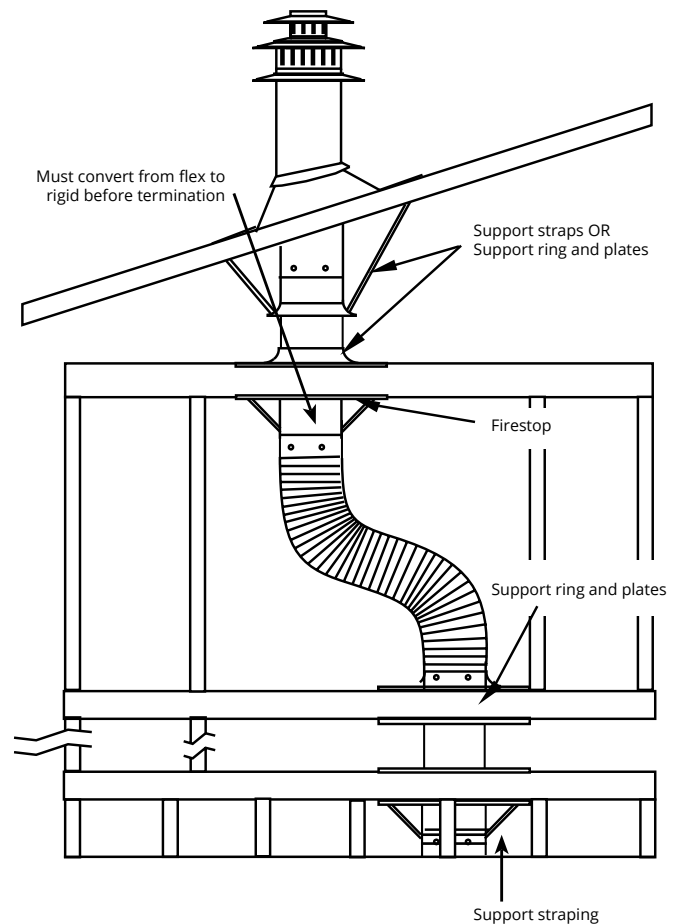



## Section 4: Wiring

### DRSQ (N/L) I Wiring Diagram

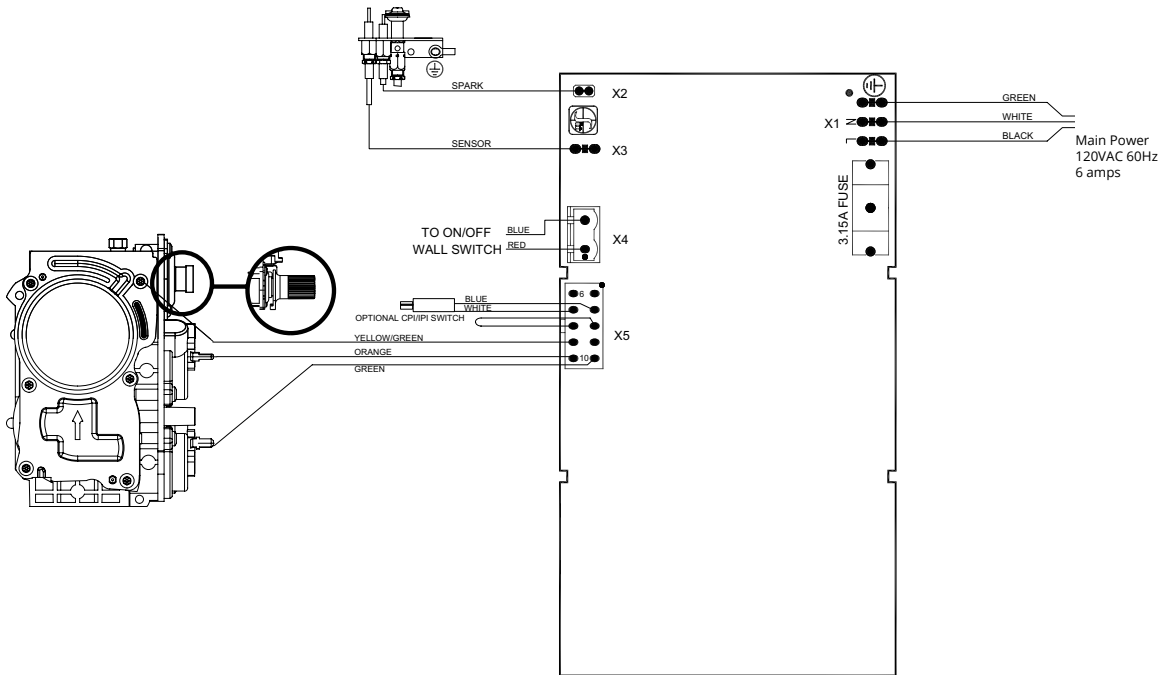

Figure 15. Wiring diagram for DRSQ\*\*\*I with SIT Proflame Electronic Ignition

MODEL	
DRSQ42NI	DRSQ46NI
DRSQ42LI	DRSQ46LI

### Installation of the wall switch

Montigo supplies 15' of low voltage wire to be plugged into the control board. Connect to a standard single pole ON/OFF switch to the location of your choice. You may extend these wires up to 30' in length with a wire of equal quality.

Installations in Canada must be electrically grounded in accordance with CSA C22.1 Canadian Electrical Code Part 1 and/or Local Codes.

Installations in the USA must be electrically grounded in accordance with local codes or, in the absence of local codes, with the National Electrical Code, ANSI/NFPA 70.

Optional remote control available through your Montigo Dealer.

## DRSQ (N/L) I-2 Wiring Diagram

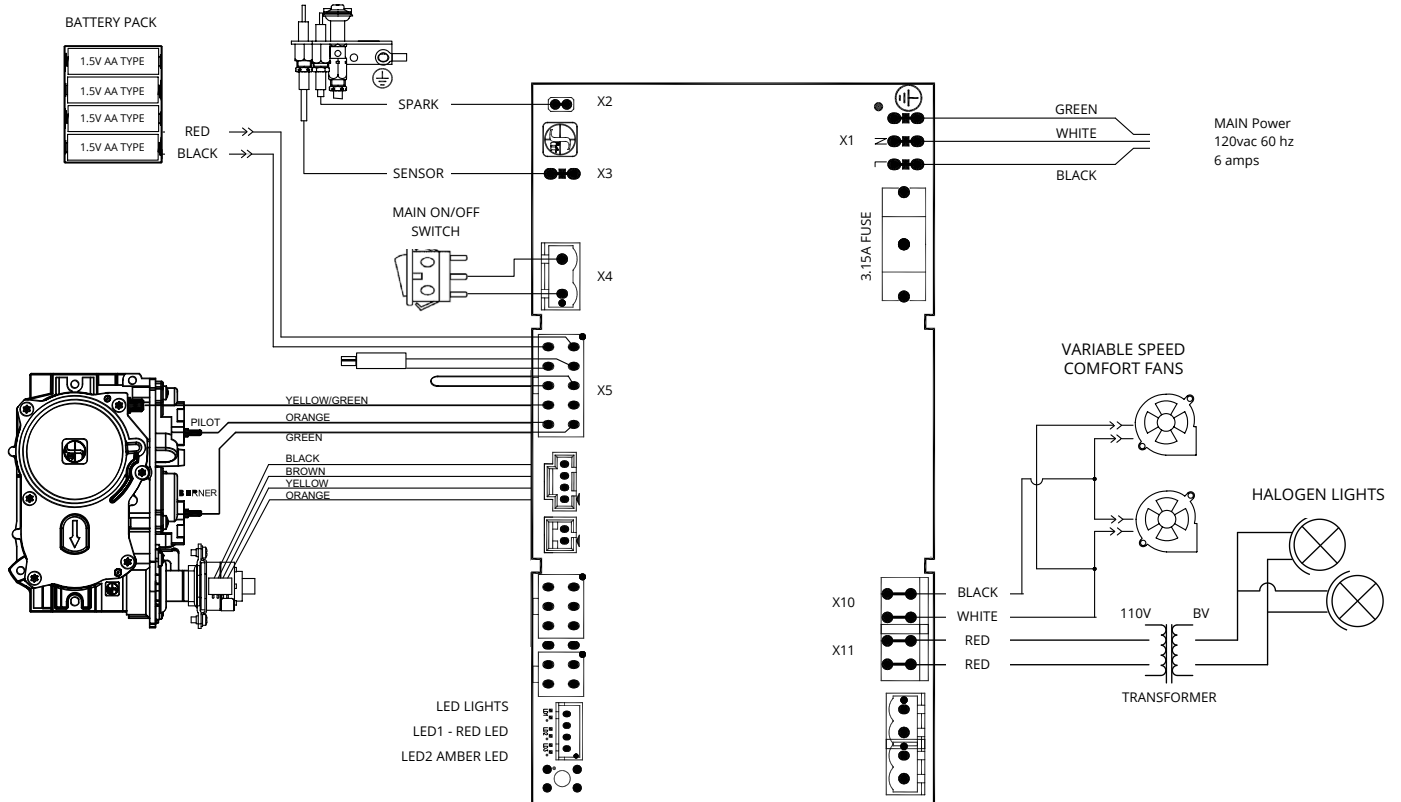

Figure 15b. Wiring diagram for DRSQ38\*I-2 with SIT Profame Electronic Ignition

MODEL	
DRSQ42NI-2	DRSQ46NI-2
DRSQ42LI-2	DRSQ46LI-2

## Installation of Electrical Supply

Installations in Canada must be electrically grounded in accordance with CSA C22.1 Canadian Electrical Code Part 1 and/or Local Codes.

Installations in the USA must be grounded in accordance with local codes or, in the absence of local codes, with the National Electrical Code, ANSI/NFPA 70.

NOTE: If any of the original wire supplied with the appliance is replaced, it must be replaced with the same type, or its equivalent.

## Section 5: Installing the gas line

### Fuel Type

- Verify that your fireplace is compatible with your available gas type. (Natural Gas or Propane shown by "N" or "L" in your model number)
- If gas type is not compatible, contact your local Montigo dealer.

### Gas Pressure

- Optimum appliance performance requires proper input pressures.
- Gas line sizing requirements will be determined in ANSI Z223.1/NFPA 54 National Fuel Gas Code in the USA and CAN/CGA B149.1 in Canada.

#### Pressure requirements (during operation):

PRESSURE REQUIREMENTS		
Gas Pressure	Natural Gas	Propane
Minimum inlet pressure	5.5in. w.c.	11in. w.c.
Manifold pressure	3.5in. w.c.	10in. w.c.

Figure 17. Pressure Requirements

- The manifold outlet pressure is set from the factory to the appropriate pressure but should be verified.
- Montigo requires a service shut off valve be located in an accessible location to isolate the gas supply.
- Only install gas shut-off valves approved for use by the state, province, or other governing body in which the fireplace is being installed.

### Section 5-3: GAS CONNECTION

- See dimensional drawing for location of gas line access.
- Flexible gas connectors must not exceed 2 feet in length, unless allowable within local regulations.
- Connect incoming gas line to the ½" or ¾" gas inlet port.
- Check appliance connection, valve and valve train under normal operating pressure with a commercially available leak check solution.

**DO NOT USE A FLAME OF ANY KIND TO TEST FOR LEAKS.**

### NOTICE

When pressure testing the fireplace, gas line, and input system follow the appropriate local codes for your area. **DO NOT** connect the fireplace to pressures in excess of **0.5 psig. (14" w.c.)** This will damage the gas control valve.

### ⚠ DANGER

After gas line is connected, each appliance connection, valve and valve train **MUST** be checked while under normal operating pressure with either a Liquid Solution, or Leak Detection Device, to locate any source of leak. Tighten any areas where bubbling appears or a leak is detected until bubbling stops completely or leak is no longer detected. **DO NOT** use a flame of any kind to test for leaks. A fire or explosion will occur, causing serious injury, property damage or death.

### ⚠ WARNING

An inspection of the door **MUST** be made prior to lighting the fireplace. A faulty seal on the door gasket will result in products of combustion leaking into the living space and may result in carbon monoxide poisoning.

### Primary air adjustment

During initial installation, check primary air opening (below are factory settings):

- DRSQ42\*1** ⅜" for NG and ⅝" for Propane;
- DRSQ42\*I-2** ⅜" for NG and ⅝" for Propane.
- DRSQ46\*1** ⅜" for NG and ⅝" for Propane;
- DRSQ46\*I-2** ⅜" for NG and ⅝" for Propane.

The primary air might need adjusting from the factory setting for vertical runs. If flame is sooting, primary air may need to be opened slightly. Smaller primary air opening means yellower flame.

**Note:** all adjustments to primary air must be made by qualified installers. Very small changes in opening size make major changes in flame appearance



Depending on desired flame appearance recommended primary air adjustment limits: NG ⅜" – ¼" and propane ⅝" – Full open.

## Section 6: Finishing

### Finishing Around the Fireplace

#### Fireplace Facing

When sizing the finish material for your fireplace, it is important to remember the following: THE OPENING MUST NOT BE OBSTRUCTED IN ANYWAY - to do so restricts the air supply for the control compartments and it also prevents access for servicing controls.

#### DRSQ42, DRSQ46 Mantels

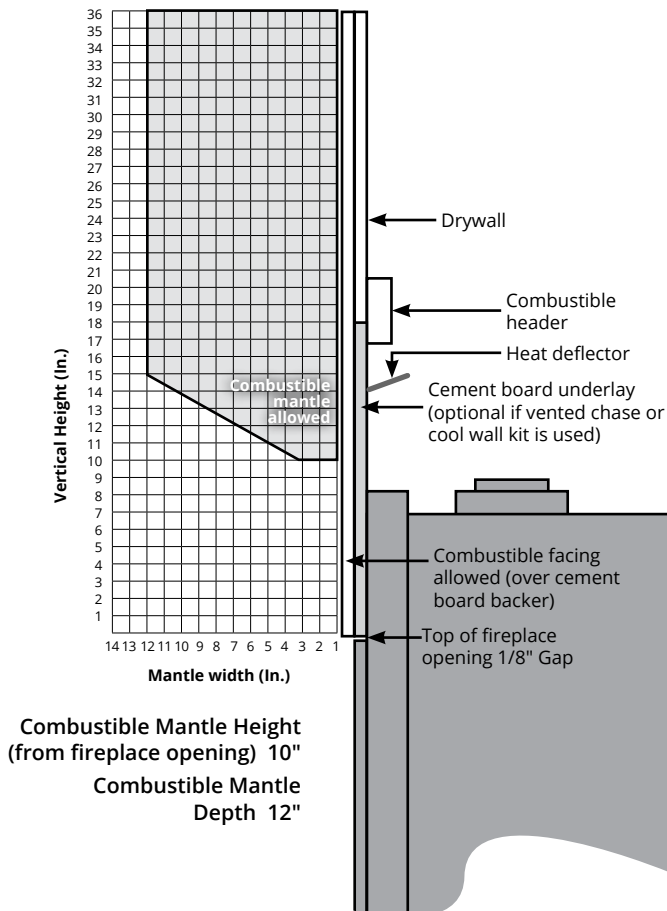

**! WARNING**

Fireplaces cannot be recessed into a wall cavity.

#### DRSQ42, DRSQ46 Mantels (With vented chase or cool wall kit)

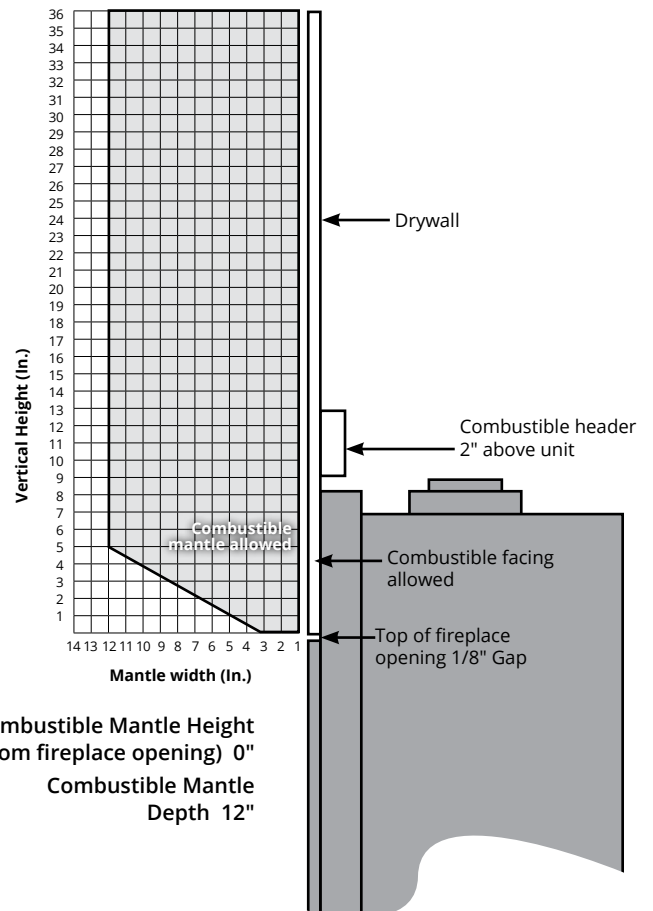

CAUTION

We recommend careful consideration be given to the effects of elevated mantel temperatures which may be in excess of product design, for example: candles, plastic or pictures. This can cause melting, deformation, discoloration or premature failure of T.V. radio, and other electronic components.

## Sidewall clearances

Side wall clearances are 7". Combustible surrounds may be installed with 7" clearance to the edge of the opening as shown.

**Combustible surround is permissible flush to opening when the chase is vented AND fireplace venting ports are opened.**

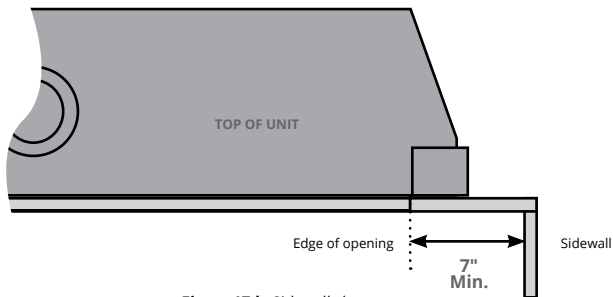

Figure 17.b Sidewall clearances

## NOTICE

7" clearance in sidewall drawing does not apply to recession, unit cannot be recessed into a wall.

## Finishing Safety Zone

Take special care when finishing underneath the fireplace door due to the location of the gas valve and control board. Any screw can possibly puncture one of these components resulting in either a non operational unit or worse, a gas leak.

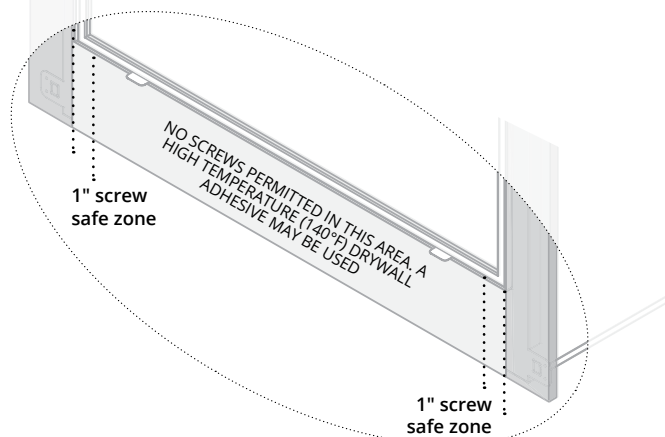

## Cement Board Install

Install the supplied non-combustible cement board to overlap the new horizontal & vertical 2 x 4's, place the cement board above the fireplace throat, allowing 1/8" clearance from the rim above the fireplace throat (opening). Secure the cement board to framing with drywall screws. Drive screws flush with the surface of the board.

### SINGLE SIDED

Top (Qty 1)

Sides (Qty 2)

Bottom (Qty 1)

Cut standard Gyproc / Drywall board to complete the installation of the surround. Fit the edge of the board to the rim around the fireplace opening. Fasten the board in place using standard drywall screws.

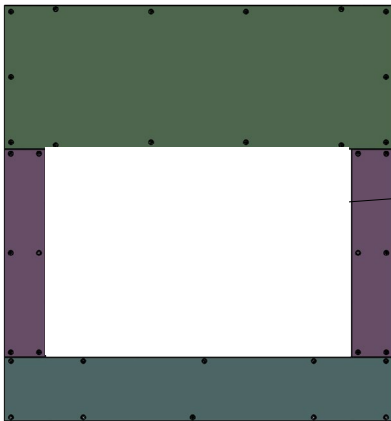

DRSQ42	
Top	48" x 18 1/4"
Bottom	48" x 7 1/16"
Sides	5 1/16" x 27 1/16"

DRSQ46	
Top	52" x 18 1/4"
Bottom	52" x 7 1/16"
Sides	5 1/16" x 31 1/16"

Figure 17.c Supplied non-combustible cement board dimensions

## NOTICE

Supplied cement board can be drilled to add extra fasteners or support if finishing application calls for it. No extra fasteners shall be used to attach cement board to fireplace body

## NOTICE

Cement board installation is not required when venting the chase or using a cool wall kit.

## STONE FACINGS

One piece stone, marble, granite that is cut in U shape to cover the sides and top areas around fireplace is not recommended. Doing so can lead to crack formation due to thermal expansion.

Before using any polished stone facing material, especially light colored one, run heat exposure tests on a samples and check for discoloration and breakage or chipping. Polyester or epoxy resin coatings might be used to strengthen, seal and polish natural stone. These coatings might structurally fail when exposed to heat. Sample pieces should be exposed to 300°F for at least 8 hours. Compare heat exposed sample to unheated piece and judge for color change, cracking and chipping.

If finishing material is sensitive to heat (discoloration or chipping) or single piece stone finishing is desired, Cool Wall Advantage kit must be used. This will greatly reduce temperatures to finishing materials

## NOTICE

It is highly recommended to apply high temp resistant RTV Silicone where cement board touches fireplace body. At least 48h cure time before applying finishing or firing fireplace

## NOTICE

Supplied cement board is for minimum installation requirements for non-combustible surfaces. When installing heavy finishing materials such as Natural Stone, Granite, Marble, Etc., Full sheets (4'x8') of cement board is recommended to minimize number of joints and to reduce risk of cracking (supplied cement board can be used as stencil to pre-drill the board with a 1/8" drill bit in the new calcium silicate based cement sheets)

## PRIMERS, ADHESIVES & MORTAR

Use caution when selecting primers and adhesives. Mortar should be high temperature rated. Premixed tile adhesives should be avoided because of long cure times and periods of off gassing and high possibility of shrinkage. Modified tile thinset is not recommended (unless adhesive manufacturer approves fireplace installation) because modifiers in thinset can offgass or cause shrinkage then exposed to heat.

Unmodified and unmixed Portland cement based mortar is recommended for tile and stone. Please confirm with finishing material manufacturer if adhesion is sufficient.

## 1" Adjustable trim kit

### Fireplace Facing

When sizing the finish material for your fireplace, it is important to remember the following: THE OPENING MUST NOT BE OBSTRUCTED IN ANYWAY - to do so restricts the air supply for the control compartments and it also prevents access for servicing controls.

- 1 The facing material should be fully finished before installation of the trim kit.



- 2 Slide the side pieces into the top and bottom tracks.

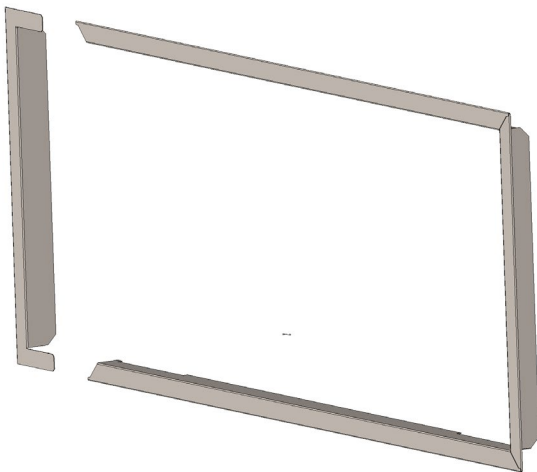

- 3 Ensure the all 4 corners of the trim kit are squared off. Before installation orient the trim so the notched section is on the bottom.

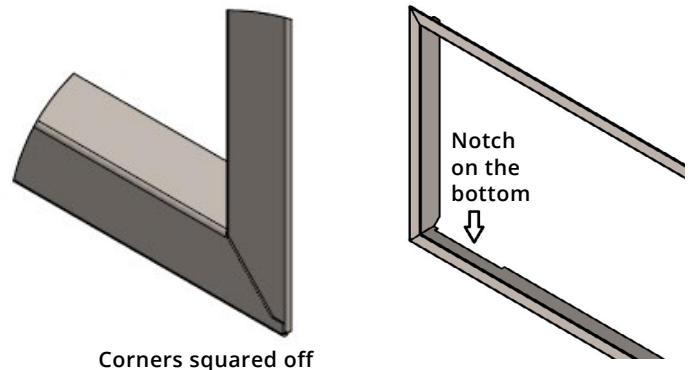

Corners squared off

- 4 The Trim slides on the inside of the flush frame of the opening. Push in until the trim is flush with the facing material.

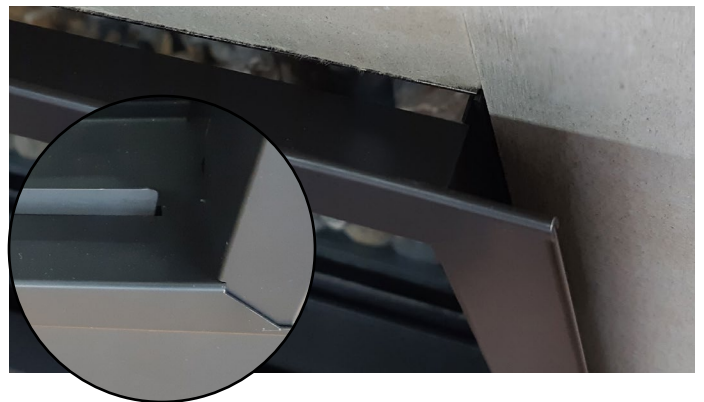

- 5 The trim can slide in and out to the full depth of the facing material providing it falls within the depth limits of the trim kit. A construction adhesive can be used to better secure the trim.

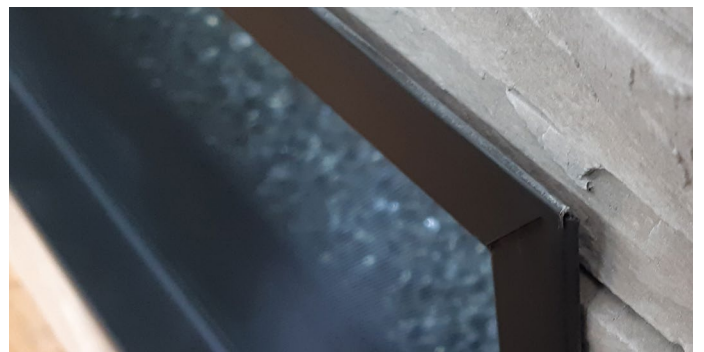

## Remote Operation (Full load DelRay Square)

The Proflame 2 System consists of the following elements:

1. Pilot Assembly
2. Proflame Gas Valve.
3. Proflame 2 Control Module
4. Wiring Harness
5. Variable Speed fans
6. Downlighting
7. Proflame 2 remote control
8. Battery Pack

**NOTE:** Can not be used with home automation systems.

The Proflame 2 Transmitter controls the following fireplace functions:

1. Main Burner On/Off
2. Choice of standing or intermittent pilot (CPI/IPI).
3. Thermostat and Smart thermostat functions.
4. Halogen downlighting
5. Fan speed modulation (6 levels).

The Proflame 2 Transmitter uses a streamlined design with a simple button layout and informative LCD display. A Mode Key is provided to index between the features and a Thermostat Key is used to turn On/Off or index through Thermostat functions, see Figure 26. Additionally, a Key Lock feature is provided.



Figure 29. Proflame 2 Remote

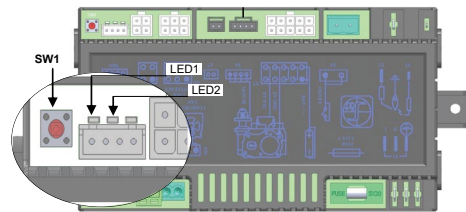

SW1 = Programing Button

LED1 = Red Diagnostic Light

LED2 = Amber Programing Remote Control Light

Figure 29.b Proflame 2 Control Module

### ⚠ WARNING

Do not expose remote control to temperatures below 0°C (32°F) or above 50°C (122°F)

### ⚠ CAUTION

**Property Damage Hazard. Excessive heat can cause property damage.**  
The appliance can stay lit for many hours. Turn off the appliance if it is not going to be attended for any length of time.

### ⚠ WARNING

**Battery operated device.** Read the battery instructions before installing them into the system. Do not expose any battery, or its holder, or a device in which batteries are installed, to a working temperature greater than 54°C / 129°F

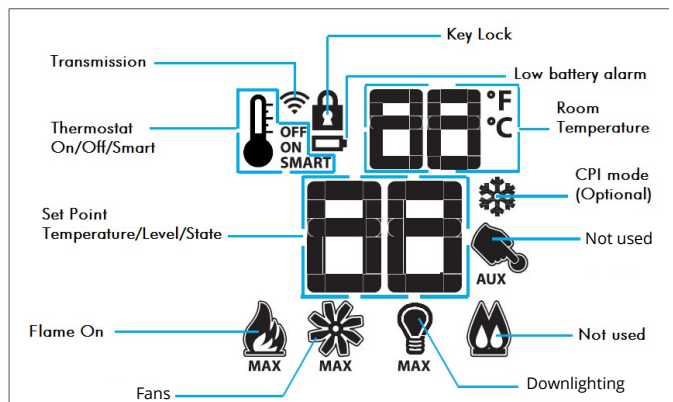

Figure 29.c Remote Control LCD Display



## Initializing the System for the first time

1. Set master override switch to off position.
2. Install four (4) AA batteries into the battery holder.
3. Install three (3) AAA batteries in the back of the remote control. Note the polarity of batteries and install them as indicated by the silk screen (+/-) on the holder.
4. Connect AC Power (115 volts, 60 Hz) to fireplace.

## Operating the System for the first time

Press SW1 button on the control module. The control module will beep three (3) times and an amber LED is illuminated to indicate that the IFC (control board) is ready to synchronize with a remote control within 10 sec. Push the ON button. The control module will "beep" four (4) times to indicate transmitter's command is accepted.

The System is now initialized.

## Temperature Indication Display

With the system in the "Off" position, press the Thermostat Key and the Mode Key at the same time. Look at the LCD screen on the Remote Control to verify that a C or F is visible to the right of the Room Temperature display.

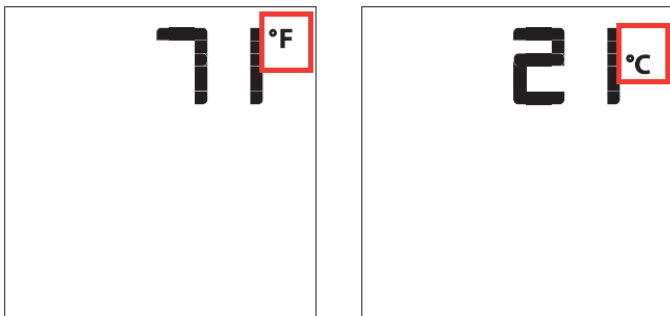

Figure 27.e Remote Control display in Fahrenheit & Celsius

## Turn On the Fireplace

With the system Off, turn the master override switch to on and press the On/Off Key on the Remote Control. The Remote Control display will show some other active Icons on the screen. At the same time the Control Module will activate the fireplace. A single "beep" from the Control Module will confirm reception of the command.

## Turn Off the Fireplace

With the system On, press the On/Off Key on the Remote Control. The Remote Control LCD display will only show the room temperature. At the same time the Control Module will turn off the fireplace. A single "beep" from the Receiver confirms reception of the command.

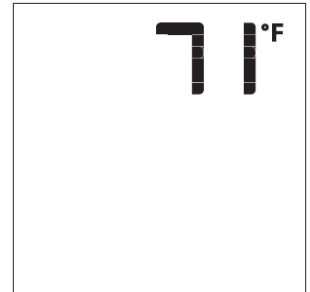

Figure 27.f Remote Control Display

## Accent Light Control

The fireplace is equipped with variable accent lights. The accent light function controls the Accent Lights. To activate this function use the Mode Key, see Figure 8 Sec.10, to index to the accent light icon.

Pressing the Up Arrow Key will turn the light on at the lowest setting. Continue pressing up to get brighter. Pressing the Down Arrow Key will turn the lights down until you get to the off position. A single beep will confirm the reception of the command.

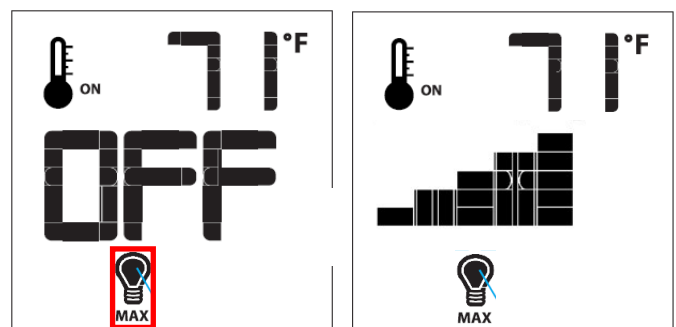

Figure 9.21 Light Control

## Room Thermostat (Remote Control Operation)

The Remote Control can operate as a room thermostat. The thermostat can be set to a desired temperature to control the comfort level in a room. To activate the function, press the Thermostat Key, see Figure 27i. The LCD display on the remote control will change to show that the room thermostat is "On" and the set temperature is now displayed. To adjust the set temperature press the Up or Down Arrow Keys until the desired set temperature is displayed on the LCD screen of the Transmitter.

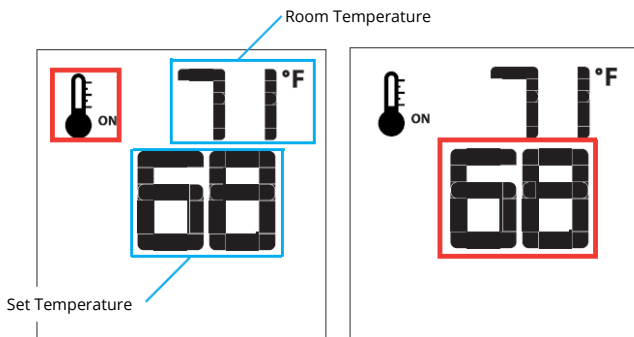

Figure 27.i Setting Room Thermostat

## Smart Thermostat (Remote Control Operation)

The Smart Thermostat function adjusts the flame height in accordance to the difference between the set point temperature and the actual room temperatures. As the room temperature gets closer to the set point the Smart Function will modulate the flame down. To activate the function, press the Thermostat Key, see Figure 27.j, until the word "SMART" appears to the right of the temperature bulb graphic, see Figure 27j.

NOTE: When smart Thermostat is activated, manual flame height adjustment is disabled.

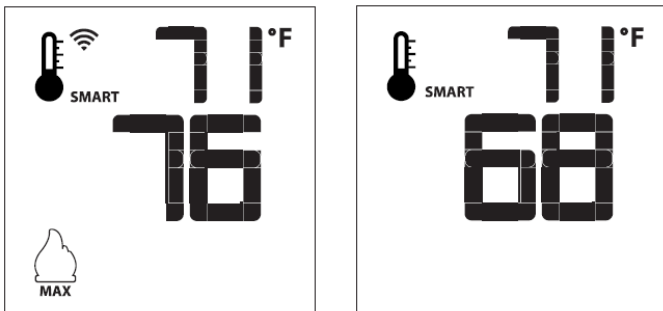

Figure 27.j Smart flame function

## Disabling Thermostat

Some jurisdictions and bedroom installations require the thermostat to be disabled.

1. Partially take out one battery. Insert the battery while holding down the thermostat button. The remote screen will display 'Clr' while the button is held down.
2. To enable thermostat repeat steps 1-2. The remote screen will display 'set' while the thermostat button is held down.

## Fan Speed Control

The fireplace is equipped with optional hot air circulating fans. The speed of the fans can be controlled by the Proflame system. The fan speed can be adjusted through six (6) speeds. To activate this function use the Mode Key, see Figure 27, to index to the fan control icon, see Figure 27m. Use the Up/Down Arrow Keys to turn on, off, or adjust the fan speed. A single "beep" will confirm reception of the command.

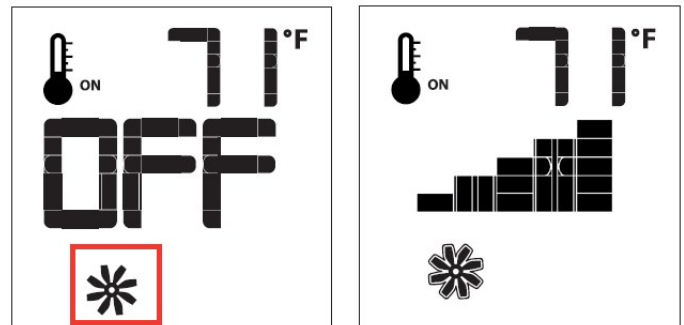

Figure 27.m Fan Speed Control

## Section 8: Removing & Installing the Screen / Door

### Removing the Screen

The trim kit, if installed, should be removed before attempting to remove the screen. Follow the steps below to remove, or install the fireplace screen and door. Before beginning any screen or glass removal, make sure that the unit has not been in operation and that it is at room temperature.

**Step 1:** Locate the three tabs at the base of the screen.



Figure 20. Locate the three tabs at the base of the screen

**Step 2:** Lift out the Retaining Tabs and screen.

Pull the bottom of the screen upward then outward, then slide out the screen from the frame.

Store in a safe place. The Screen is very fragile and can be easily torn, dented or deformed. Refer to Figure 20.b below.

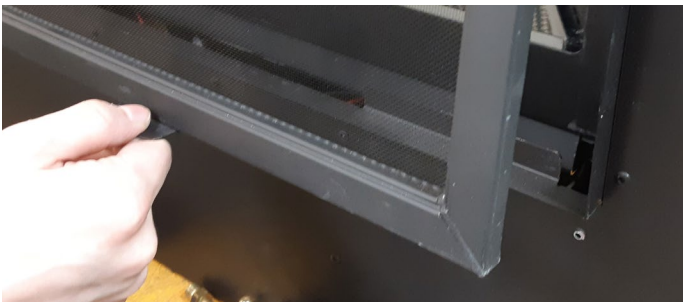

Figure 20.b Lift out the Retaining Tabs and screen

### Reinstalling the Screen

Follow the two previous steps to re-install the fireplace window.

#### NOTICE

Any safety screen, guard, or barrier removed for servicing an appliance, must be replaced prior to operating the appliance

### Removing the door

The door is removed in a few simple steps. Follow these steps below to unlatch the door buckles and remove the door.

**STEP 1:**

Remove lower valve blinds and screen setting bar.

**STEP 2:**

Ensure the tool is firmly in the lower end of the slot, (as shown), Then pull toward you, door will unlatch, repeat for other buckle.

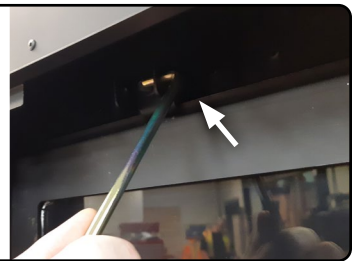

Figure 21.d Pull door latches

**STEP 3:**

Pull the top of the door towards you, then lift the door up and out of the fireplace frame.

Store in a safe place.



Figure 21.e Lift the door

### Reinstalling the door

NOTE: Make sure the top and base of the door slips into the narrow channel in the frame to ensure proper placement.

**STEP 1:**

Push the bottom of the door into the door frame channel. push the top of the door into place below the buckles.



Figure 21.e Lift the door

**STEP 2:**

Buckles are locked into place by pulling out and up, latch will pop into place.

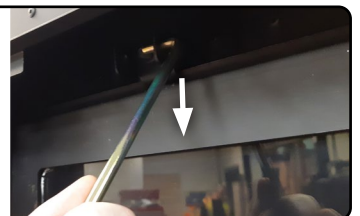

Figure 21.d Pull door latches

## Airflow Bracket Installation

- 1** The air deflector on fully loaded models is shipped sitting on the valve blind.



- 2** Remove from bubble wrap.



- 3** Install the air deflector by affixing the magnets to the top of the door frame. Note the orientation of the deflector pointed down, as well as the gaps for the door brackets



## ⚠ CAUTION

The gas supply shall be shut off prior to disconnecting the electrical power, before proceeding with the conversion.

## Propane Conversion

To convert the DelRay from Natural Gas to Propane, install the conversion kit listed below. The unit must be disconnected from any gas supply, disconnected from any electrical supply and batteries and removed from any installation cavity.

PROPANE CONVERSION KIT TABLE		
Conv. kit	<b>GCA025</b>	<b>GCA026</b>
LP orifice	1.5 mm	1.5 mm
Compatible Units	DRSQ42NI	DRSQ42NI-2
Conv. kit	<b>GCA023</b>	<b>GCA024</b>
LP orifice	1.7 mm	1.7 mm
Compatible Units	DRSQ46NI	DRSQ46NI-2

**DRSQ42\*1** 3/16" for NG and 3/8" for Propane;

**DRSQ42\*1-2** 3/16" for NG and 3/8" for Propane.

**DRSQ46\*1** 3/16" for NG and 3/8" for Propane;

**DRSQ46\*1-2** 3/16" for NG and 3/8" for Propane.

**For input rating, manifold pressure and orifice size, refer to sample rating plate**

### Tools required

- 1). Torx T20 Screw Driver Bit
- 2). 1/2" Socket Driver
- 3). 5/32" Allen Key
- 4). Needle Nose Pliers or Small Flat Head Screw Driver
- 5). 3/8" wrench

### Parts included

- 1). Propane burner orifice
- 2). Propane pilot orifice
- 3). Propane valve control (with mounting screws)
- 4). Valve conversion label
- 5). Conversion plate label
- 6). Conversion technician identifying label

## ⚠ WARNING

This conversion kit shall be installed by a qualified gas fitter in accordance with the manufacturer's instructions and all applicable codes and requirements of the authority having jurisdiction. If the information in these instructions is not followed exactly, a fire, explosion or production of carbon monoxide may result causing property damage, personal injury or loss of life. The qualified service agency is responsible for the proper installation of this kit. The installation is not proper and complete until the operation of the converted appliance is checked as specified in the manufacturer's instructions supplied with the kit.

1. Shut off gas supply.

2. Remove the 2 screws securing the pilot cover to the media tray.



Figure 13. Removal of pilot cover

3. Burner can now be removed by simply lifting up.



Figure 13.b Removing burner

4. Use 3/8" wrench to loosen off the NG gas orifice, replace with Propane orifice as included in package.

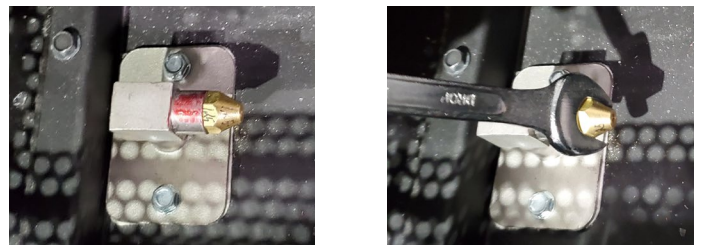

Figure 13.c Removing the orifice

5. Using a Phillips screwdriver, loosen the screw on the primary air adjuster. Adjust opening based on the chart show before step 1.



Figure 13.c primary air adjuster

6. Use screwdriver to carefully detach spring clip from the pilot hood.



**Figure 13.d** Removing the spring clip

7. Remove the pilot hood and use the 5/32" allen key to remove the natural gas pilot orifice, and replace with propane pilot orifice.

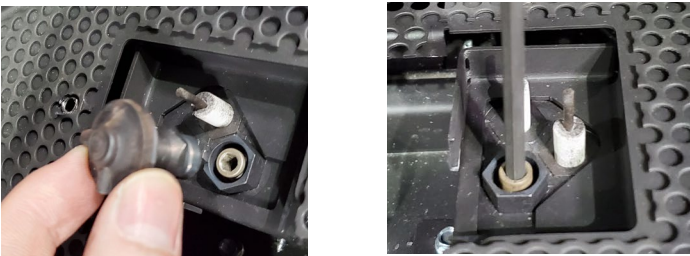

**Figure 13.e** Removing the pilot hood, orifice

8. Reassemble pilot assembly and hood.

9. See regulator instructions for guide on converting the pressure regulator gasket.

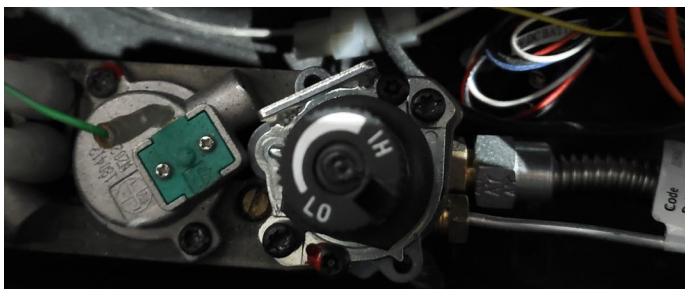
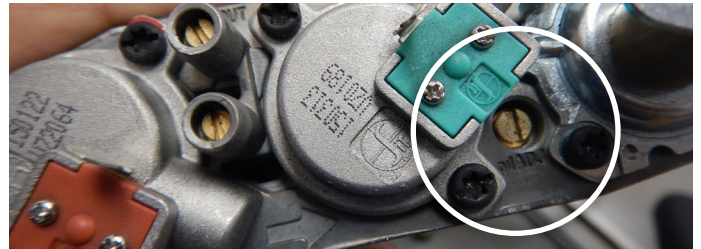

**Figure 13.ee** LP pressure regulator on a Basic



**Figure 13.eee** LP pressure regulator on a Full Load

10. If necessary, pilot flame size can be adjusted using a flathead screwdriver to adjust "pilADJ" screw shown



**Figure 13.g** Adjust pilot size

11. The manifold and inlet pressure can be verified by using a manometer and a 1/8" rubber hose attached to the valve ports shown here (top is manifold, bottom is inlet) Use a soap-based leak testing solution on the valve regulator while the unit is operating to check for any leaks

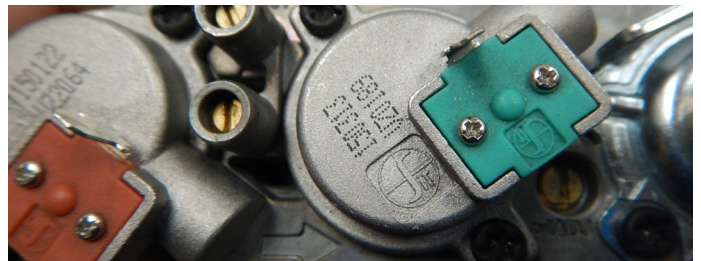

**Figure 13.h** Adjust pressure ports

12. Fill out required information on Propane conversion gas fitter sign off label, attach to reverse side of rating plate. Attach Rating plate conversion label to rating plate label. Place Valve conversion label on valve face.

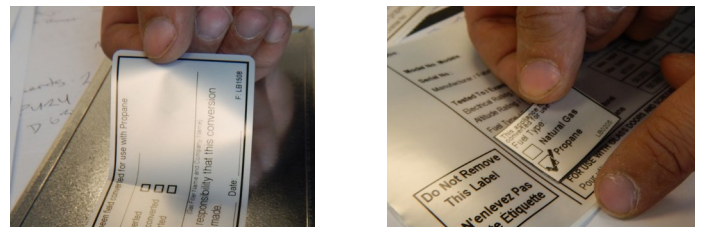

**Figure 13.i** Label reverse rating plate



**Figure 13.k** Conversion label on valve

## Section 9: Installing the Accessories

### The DelRay Square Universal burner

The burner for the DelRay Square has been developed in away that equally supports contemporary and traditional scenes without the need for a burner swap.

### Installing glass media

Optional fireglass may be purchased from the dealer. Remove the Door as shown in the previous Instruction. Once the glass door is removed place the firestones randomly across the pan and the burners.

**NOTE: ONLY COVER THE BURNER WITH ONE LAYER OF FIRESTONES OR FIREGLASS.**



Figure 24.b Completed firestone installation

**Neon Embers** Pull it apart with your fingers to avoid tangled chunks. Place them on top of where the flames are located. The neon embers should be barely visible when the flame is not lit.



Figure 24.ddd Completed ember install

**Ceramic chips** can be broken up and placed in between the stones providing they dont interfere with the burner ports.



Figure 24.dd Completed ceramic chip installation

### Installing the speckled stone media

Optional speckled stone media may be purchased from the dealer. Remove the Door as shown in the previous Instruction. Once the glass door is removed place the firestones randomly across the pan and the burners.

Note: Only cover the burner with one layer.



Figure 21.c Completed Speckled Stone installation

## Installing a contemporary scene (glass and stone)

The combination of a glass firebed with stones placed around the burner ports provide the best contemporary burn scene in terms of flame height and flame density. Place the fireglass as directed in the previous section, then the included stones can be placed as shown provided they don't cover the burner ports.



Figure 24.bb Completed firestone installation

BURNER PORTS SHOWN AS DOTTED LINE



Figure 24.cc Completed Stone installation

DRSQ  
46

BURNER PORTS SHOWN AS DOTTED LINE



Figure 24.c Completed Stone installation

DRSQ  
46



Only cover the burner with one layer of coals. Arrange the ember chips on top of the burner tray. **DO NOT** cover the pilot with logs.

**WARNING:** This appliance is intended for use only with the included Montigo burners and accessories. Never install or add any additional or alternative media, rock wool or other material in this appliance. The use of additional or alternative materials may pose potential safety hazards, damage to the appliance, and void manufacturer's warranty.

## Split Oak Logset Installation

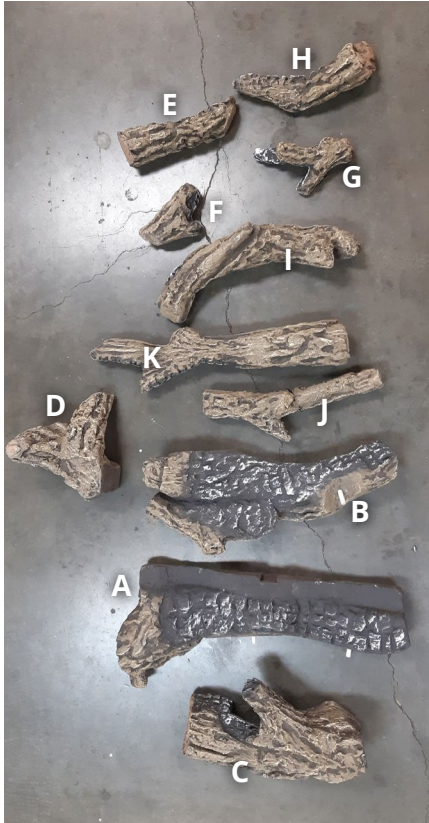

**Step 3:** Log **F** is placed in the front of the media tray. Log **E** is placed next to log **F** (with space in between).

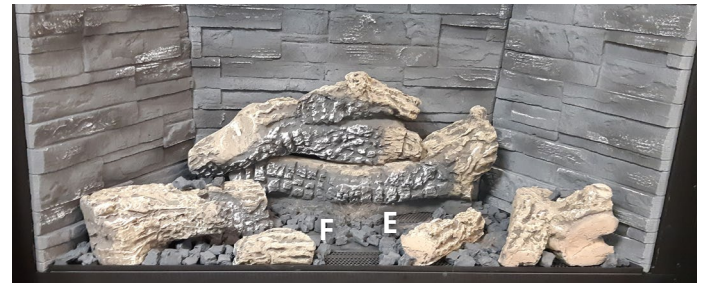

**Step 4:** Place log **G** resting between logs **B** and **C**, charred end down. Log **H** is placed resting on logs **E** and **D**.



**Step 1:** Logs **A & B** are placed directly at the middle back of the firebox. These logs should fit together as shown.

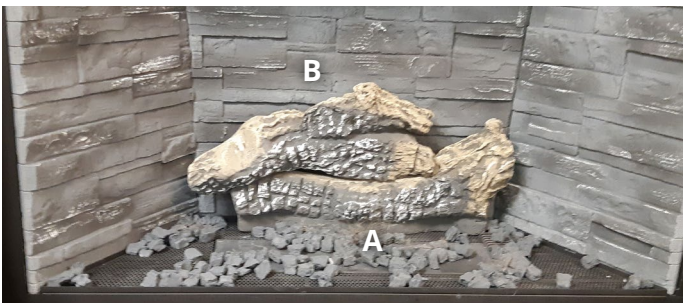

**Step 5:** Rest log **I** between log **D** and **B**. Log **J** is placed on logs **D** and **A**, charred side in.



**Step 2:** Log **C** is placed in front left of the media tray. Log **D** is placed in the front right corner.



**Step 6:** Log **K** is placed in the front middle of the firebox, resting in the connection between logs **J** and **A**.



Only cover the burner with one layer of coals. Arrange the ember chips on top of the burner tray. DO NOT cover the pilot with logs.

**WARNING:** This appliance is intended for use only with the included Montigo burners and accessories. Never install or add any additional or alternative media, rock wool or other material in this appliance. The use of additional or alternative materials may pose potential safety hazards, damage to the appliance, and void manufacturer's warranty.

## Birch Logset Installation 42

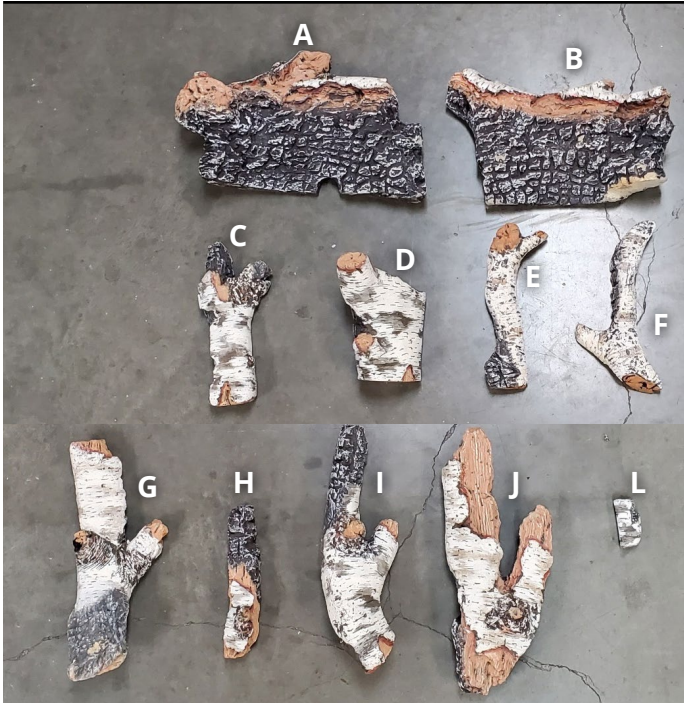

**Step 3:** Log **I** is placed in the left side of the firebox, with the charred end placed in front of log A. Log **L** is set between logs I and J.



**Step 4:** Place log **G** with the ends resting on logs A and J (charred end on J) Log **C** rests between log B and D (forked end up)

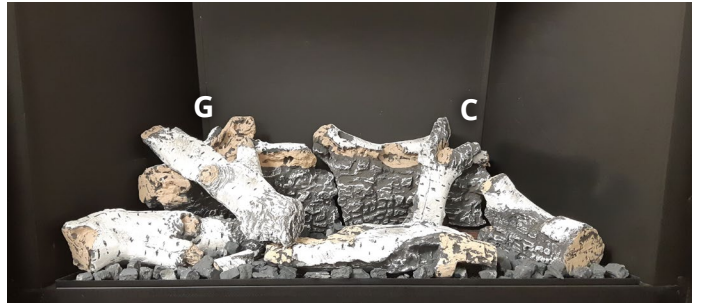

**Step 1:** Logs **A & B** are placed directly at the middle back of the firebox. These logs should fit together as shown.

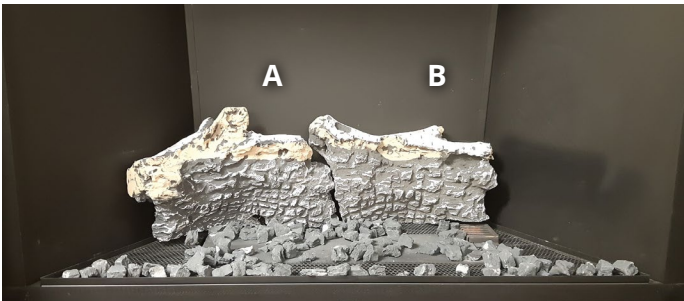

**Step 5:** Rest log **E** with the ends on log A and J (charred end down) Log **H** is on logs J and D (charred end in)



**Step 2:** Log **J** is placed in the exact middle of the media bed, Log **D** rests along the angled right side of the firebox



**Step 6:** Rest log **F** between logs C and E



# Installation

Only cover the burner with one layer of coals. Arrange the ember chips on top of the burner tray. DO NOT cover the pilot with logs.

**WARNING:** This appliance is intended for use only with the included Montigo burners and accessories. Never install or add any additional or alternative media, rock wool or other material in this appliance. The use of additional or alternative materials may pose potential safety hazards, damage to the appliance, and void manufacturer's warranty.

DRSQ  
46

## Birch Logset Installation 46

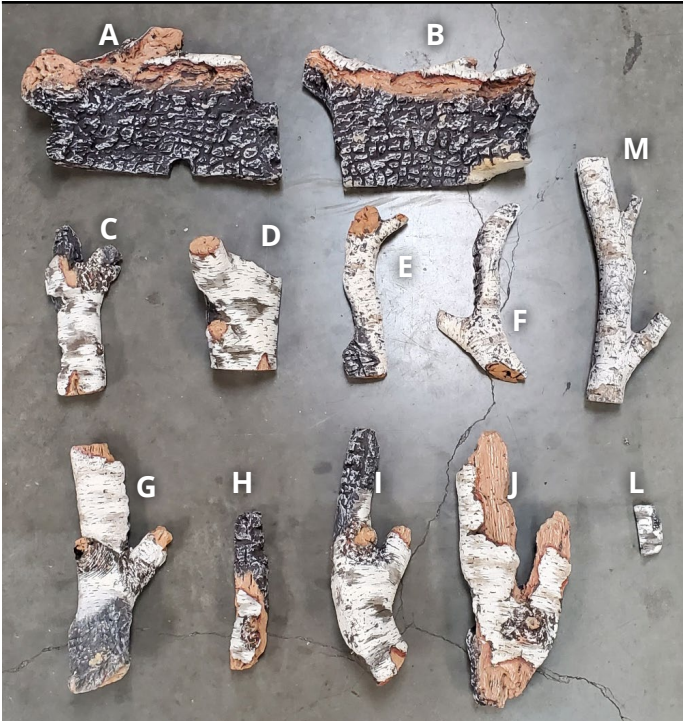

**Step 1:** Logs **A & B** are placed directly at the middle back of the firebox. These logs should fit together as shown.

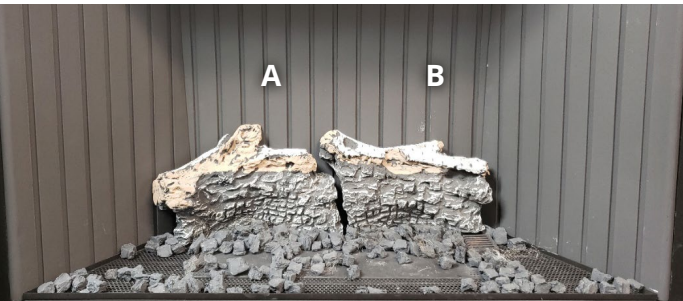

**Step 2:** Log **I** is placed in front of log A in the left of the media tray. Log **L** is tucked underneath log G.



**Step 3:** Log **F** is placed in the front of the media tray resting on log I. Log **E** is placed on logs A and I.



**Step 4:** Place log **G** vertically in the middle of the media tray, charred end down. Log **J** is placed at the base of log G to help stabilize.

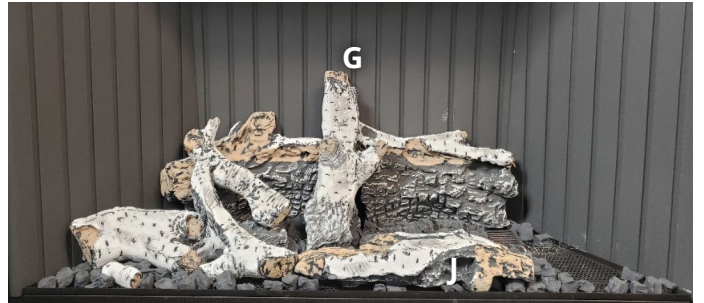

**Step 5:** Rest log **M** with the ends on log J and B. Log **D** is placed in the front right corner, charred side in.

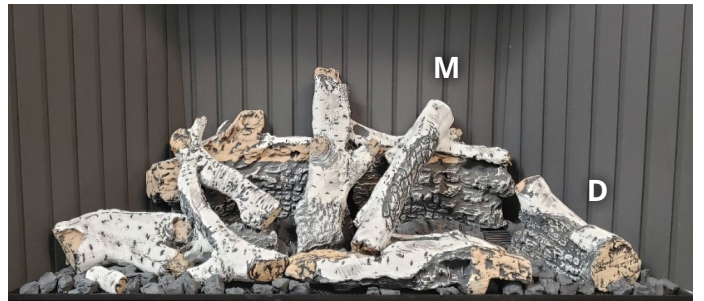

**Step 6:** Log **H** is placed in the front right corner on log D, charred side in. Log **C** rests on log B, charred side in.



**WARNING:** This appliance is intended for use only with the included Montigo burners and accessories. Never install or add any additional or alternative media, rock wool or other material in this appliance. The use of additional or alternative materials may pose potential safety hazards, damage to the appliance, and void manufacturer's warranty.

Only cover the burner with one layer of coals. Arrange the ember chips on top of the burner tray. DO NOT cover the pilot with logs.

## Driftwood Logset Installation 42

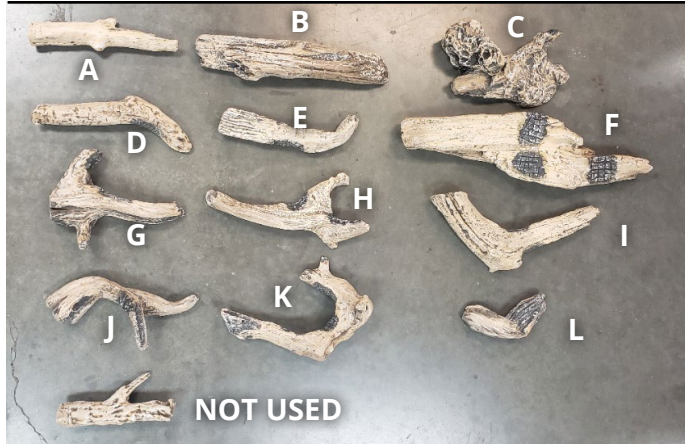

**Step 1:** Log **C** is placed at the rear left corner of the media tray

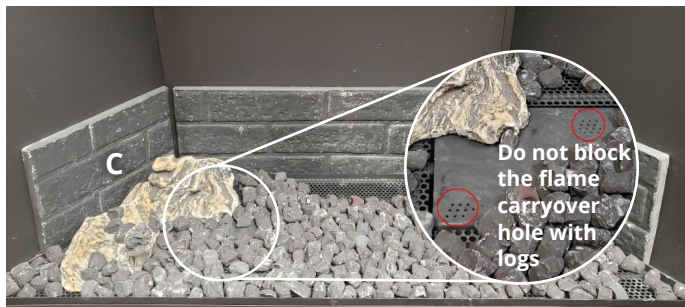

**Step 2:** Log **F** is placed at the rear center of the firebox, with one end resting on log **C**

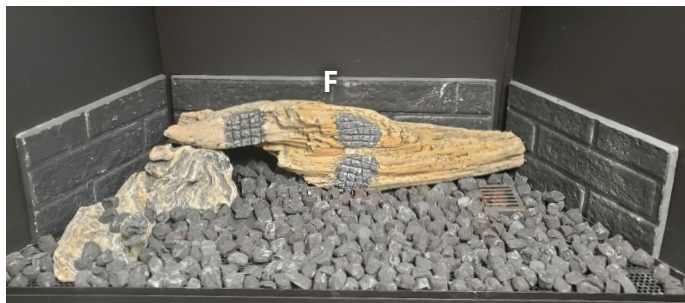

**Step 3:** Place log **I** in the middle of the media tray, with the thinner end resting on log **F**. Log **L** is placed next to the outer elbow edge of log **I**



**Step 4:** Log **B** runs along the right angled side of the firebox, with the end resting on log **I**. Log **E** is balanced with the middle on log **L**.



**Step 5:** Log **K** is placed with the bowed end on top of log **F**. Log **H** rests in between log **F** and **I**, with one end placed on **I**.

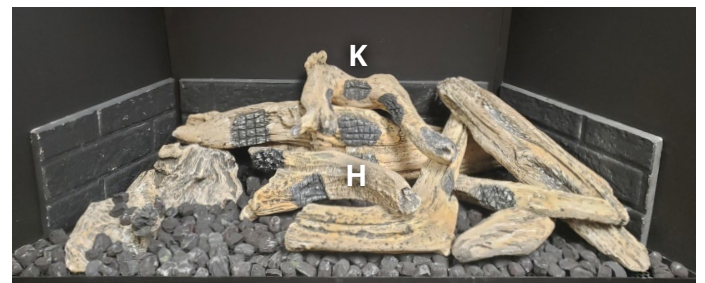

**Step 6:** Rest log **A** on log **H**, with one end in the air. Log **D** is placed in the rear left corner on log **F**.

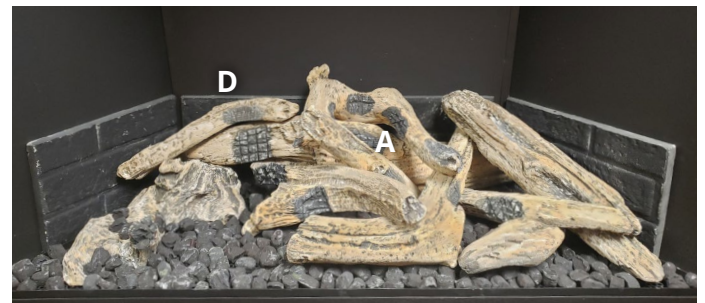

**Step 7:** Place log **J** along the angled left side of the firebox, one end rests on log **D**. Log **G** is placed with the large end in the middle of the box.



**WARNING:** This appliance is intended for use only with the included Montigo burners and accessories. Never install or add any additional or alternative media, rock wool or other material in this appliance. The use of additional or alternative materials may pose potential safety hazards, damage to the appliance, and void manufacturer's warranty.

Only cover the burner with one layer of coals. Arrange the ember chips on top of the burner tray. DO NOT cover the pilot with logs.

## Driftwood Logset Installation 46

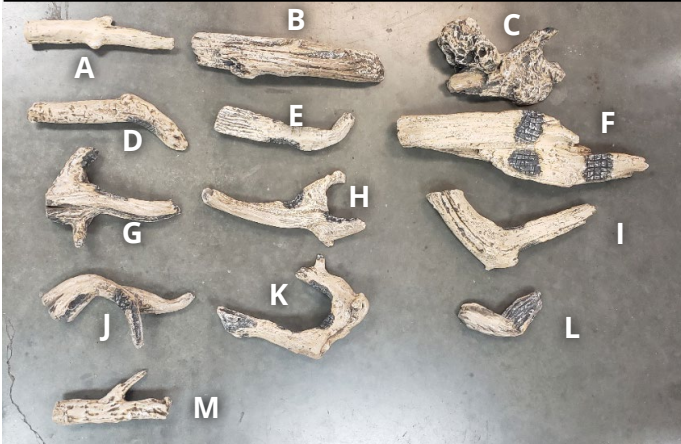

**Step 1:** Log **C** is placed at the rear left corner of the media tray

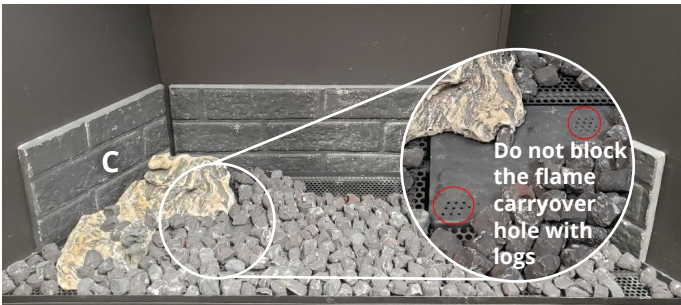

**Step 2:** Log **F** is placed at the rear center of the firebox, with one end resting on log **C**



**Step 3:** Place log **B** along the right side of the media tray, Log **J** rests ontop of log B, forked end down



**Step 4:** Log **K** rests on logs F and B, with the bowed end on the rear of the box. Place log **A** in the middle front of the media tray.

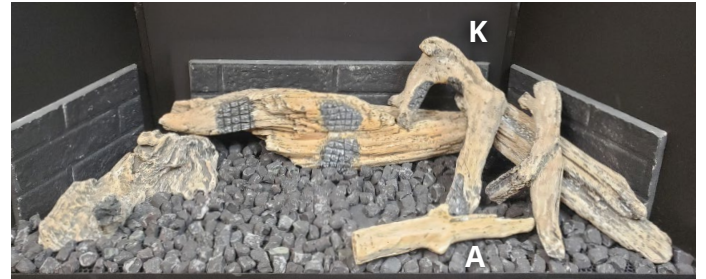

**Step 5:** Log **G** in the middle of the media tray, with log **D** right against it and tucked under log F.

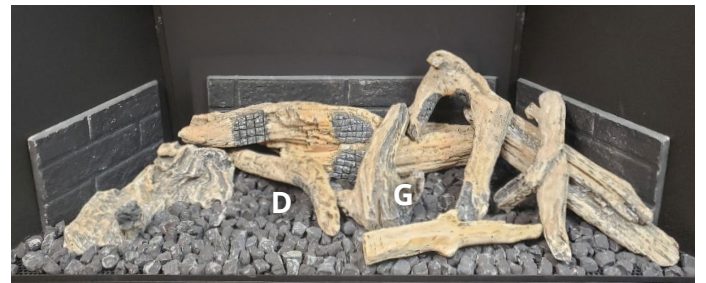

**Step 6:** Rest log **I** with the larger end sitting in the media bed, one end on log C. Log **E** is placed in the middle front of the media bed.



**Step 7:** Place log **L** along the front of the tray (front left). Log **H** is placed in the rear left corner of the box. Log **M** is placed in the front left



## NOTICE

Panels should be handled with gloves, oils from the skin will permanently stain glass

### Black Reflective Glass

Before beginning any install, make sure that the unit has not been in operation and that it is at room temperature.

**Step 1:** Identify correct bracket to use.

**Step 2:** Remove the two screws on each side where the brackets will go in

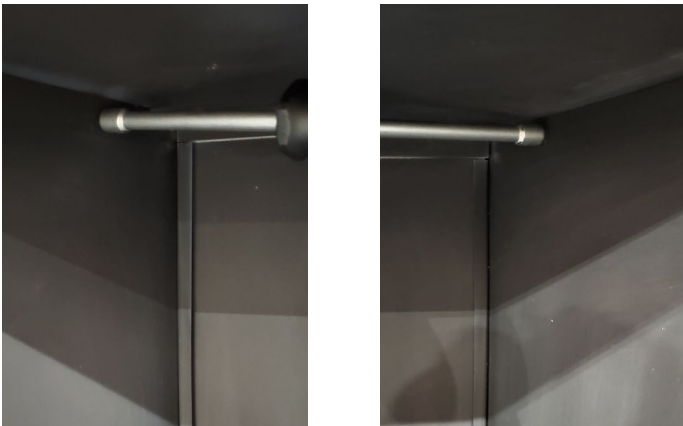

Figure 20.b Remove the two screws

**Step 3:** Put the back glass on first, and temporarily hold it in place using masking tape. Don't use regular tape as it will leave residue on the glass

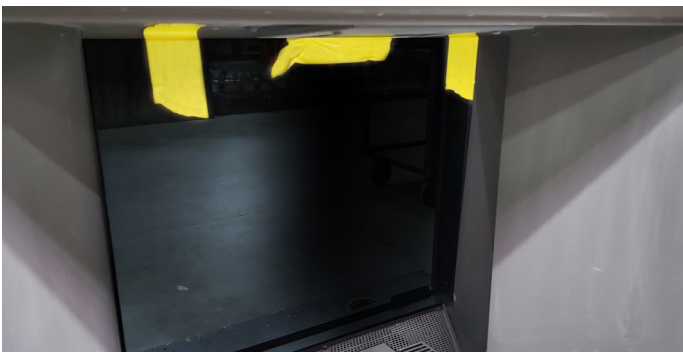

Figure 20.b hold it in place using masking tape

**Step 4:** Bend the left side tab on the bracket. Place right side glass in place, and secure with the bracket using screw

Bend the right side tab on the bracket. Place left side glass in place, and secure with the bracket using screw.



Figure 20.b Bend the left side tab



Figure 20.b Bend the right side tab

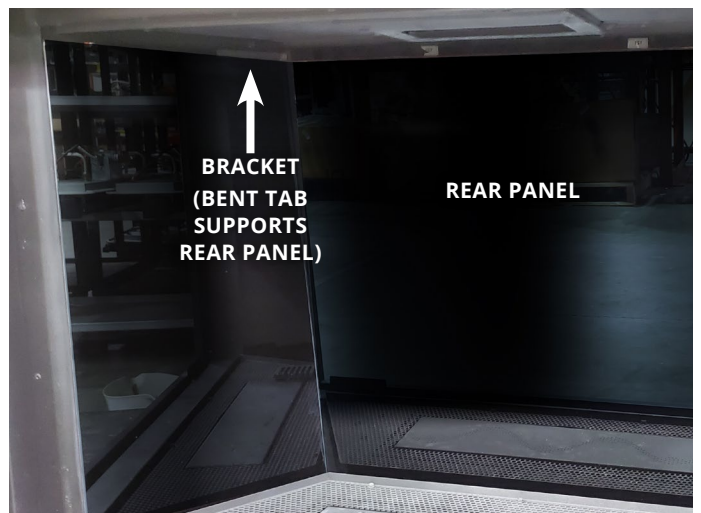

Figure 20.b Secure with the bracket using screw

**Step 5:** It is now safe to remove the masking tape.

## Brick Liner Install

Before beginning any install, make sure that the unit has not been in operation and that it is at room temperature.

**Step 1:** Remove the two screws on each side where the brackets will go in

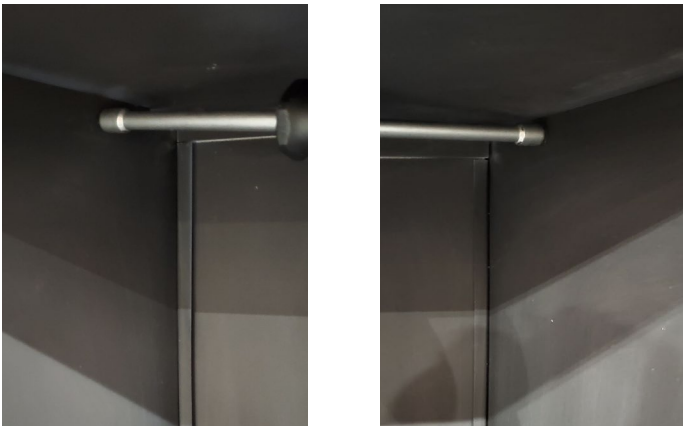

*Figure 20.b* Remove the two screws

**Step 2:** Put the back panel in first, and temporarily hold it in place or use masking tape. Don't use regular tape as it will leave residue on the panel.



*Figure 20.b* hold in place or secure using masking tape

**Step 3:** Use the included clips to secure right panel into the screw hole referenced in step 1.



*Figure 20.b* Secure with the bracket using screw

**Step 4:** Install left panel using same steps in step 3.



*Figure 20.b* Completed installation

**Step 5:** It is now safe to let the rear panel be supported by the side panels.

## FOR YOUR SAFETY - READ BEFORE LIGHTING:

DANGER



**HOT GLASS WILL CAUSE BURNS.  
DO NOT TOUCH GLASS UNTIL COOLED.**

**NEVER ALLOW CHILDREN TO TOUCH GLASS.**

A barrier designed to reduce the risk of burns from the hot viewing glass is provided with this appliance and must be installed for the protection of children and other at-risk individuals.

**WARNING: If the information in these instructions is not followed exactly, a fire or explosion may result causing property damage, personal injury or death.**

**WARNING/ CAUTION: Hot while in operation. Do not touch. Severe burns may result. Keep children, clothing, furniture, gasoline and other liquids having flammable vapours away.**

**See installation and operating instructions accompanying this appliance for more information.**

A. This appliance is equipped with an ignition system that lights the pilot burner automatically. **Do not attempt to light the pilot by hand.**

B. **BEFORE LIGHTING** smell all around the appliance area for gas. Be sure to smell next to the floor because some gas is heavier than air and will settle on the floor.

**What To Do If You Smell Gas:**

- Do not try to light any appliance.
- Do not touch any electrical switch; do not use any phone in your building.

- Immediately call your gas supplier from a neighbour's phone. Follow the gas supplier's instructions.

- If you cannot reach your gas supplier, call the Fire Department.

C. Use only your hand to operate gas control. Never use tools. If the control does not function, don't try to repair it, call a qualified service technician. Force or attempt to repair may result in a fire or explosion.

D. Do not use this appliance if any part has been under water. Immediately call a qualified service technician to inspect the appliance and to replace any part of the control system, and any gas control which has been under water.

## LIGHTING INSTRUCTIONS:

1. **STOP!** Read the safety information above on this label.
2. Turn "ON" manual "ON/OFF" switch. (If available)
3. Turn Incoming gas shut off valve to the "ON" position.
4. Wait 5 minutes to clear out any gas. If you smell gas, **STOP!** Follow "B" in the safety information above on this label. If you don't smell gas, go to the next step.
5. Turn fireplace "ON" using wall switch or remote control.
6. If the Fireplace does not light, the System will cycle through two trials, (one minute audible clicking, thirty seconds of silence, and then another one minute of audible clicking). If the system locks out due to inadequate gas flow, refer to "Troubleshooting" in instruction guide.
7. After completion of the information in the Troubleshooting section, Repeat step 5.
8. If the system will not function correctly, follow the instructions "To Turn Off Gas To Appliance" and call your service technician or gas supplier.

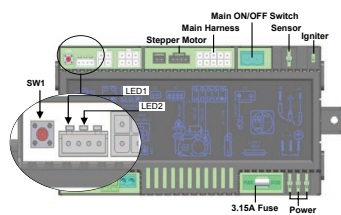

SW1 = Programming Button  
LED1 = Red Diagnostic Light  
LED2 = Amber Programming Remote Control Light  
Typical Control Module shown

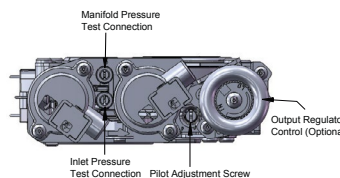

Gas Valve

## TO TURN OFF GAS TO APPLIANCE:

1. Turn off fireplace using wall switch or remote control.
2. Turn the incoming gas shut off valve to "Off".

P/N LB176-060614



## Section 10: Cleaning and Maintenance

### General

- Have the fireplace and installation inspected yearly. The inspection must include, but is not limited to, the following:
  - A visual check of the entire vent system and termination, where accessible.
  - An inspection of the explosion relief flappers and the door gaskets to ensure a proper seal.
  - An inspection of the burner, vent run, and primary air openings.
  - An inspection of the gas valve, gas components, and pilot flame. For your convenience a 1/8" manifold pressure tap is supplied on the gas valve for a test gauge connection.
  - Inspection of all optional equipment; fans, thermostats, remote control lights, etc.
- For Natural Gas this appliance requires a minimum inlet pressure of 5.5" W.C. and a manifold pressure of 3.5" W.C.
- For Propane Gas this appliance requires a minimum inlet pressure of 11" W.C. and a manifold pressure of 10" W.C.
- Always keep the fireplace area clear and free of combustibile materials, as well as gasoline and other flammable vapors and liquids.
- Do not use this appliance if any part has been under water. Immediately call a qualified service technician to inspect the appliance and to replace any part of the control system and any gas control which has been under water.
- Inspection of glass doors and screen for damage and proper installation.

### Cleaning

When the fireplace is first activated, there may be some smoke and a visible film may be left on the glass. This is a normal condition, and is the result of burning of protective coatings on new metal.

- Initially your should perform a continuous 4-6 hour burn period, then let the unit fully cool before cleaning.
- Glass must be cleaned periodically to remove any film (which is a normal by-product of combustion) which may be visible. Film can easily be removed by removing the door. Handle the door carefully, and clean it with non-abrasive, non-ammonia based glass cleaners. One of the most effective products is Kel-Kem.
- During the initial firing, Silicone seals will "off gas", leaving a visual deposit of a white substance on combustion chamber walls. This can easily be removed using normal household products.
- Use a vacuum cleaner or whisk broom to keep the control compartment, burner, and firebox free from dust and lint.

### Pilot Burner Adjustment.

1. Locate Pilot Adjustment Screw. (See **figure 28**)
2. Adjust pilot screw to provide properly sized flame as shown.
3. After installing or servicing, leak test with a soap solution with main burner on. Coat pipe and tubing joints, gasket etc. with soap solution. Bubbles indicate leaks. Tighten any areas where the bubbles appear until the bubbling stops completely.

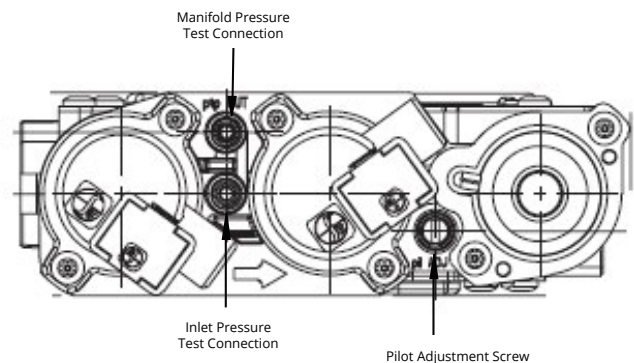

**Figure 28.** Pilot Adjustment on the SIT Proflame 2 gas valve.

### NOTICE

Do not use ammonia or abrasive cleaners on the glass, they will permanently etch the surface. Use an approved gas fireplace cleaner such as Kel-Kem or White off.

### Annual inspection list for determining safe operation of a direct vent gas fireplace

- 1) Inspect and operate the pressure relief mechanism to verify relief mechanisms are free from obstruction to operate.
- 2) Clean glass window with a suitable fireplace glass cleaner. Abrasive cleaners must not be used. Be careful not to scratch the glass when cleaning.
- 3) Inspect the operation of the flame safety system Pilot or Flame rectification device.
- 4) Inspect and ensure the lighting of the main burner occurs within 4 seconds of the main gas valve opening. Visual inspection should match that outlined in the appliance instruction manual. Inspect primary air openings for blockage.
- 5) Inspect condition of vent and vent terminal for sooting or obstruction and correct if present.
- 6) Vacuum and clean any debris in the firebox that is not supposed to be there.
- 7) Test and measure the flame failure response time of the flame safety system. It must de-energize the safety shutoff in no more than 30 seconds.
- 8) Check all accessible gas-carrying tubes, connections, pipes and other components for leaks.

## POD - Pilot on Demand

### What is POD and CPI mode?

This fireplace is equipped with an "On Demand" intermittent pilot ignition system (IPI) which also includes a continuous pilot ignition (CPI) mode with an integrated seven day timer.

In IPI mode, the pilot will light before the main burner, when the appliance is turned on using a wall switch, remote or from a thermostat. Once the appliance is turned off, the main burner and pilot flame will shut down.

The continuous (CPI) mode exists to ease the startup phase in colder climates by keeping the firebox and venting warm when the main burner is not in use. The timer automatically switches off the pilot when the appliance has not been used for seven days.

When the CPI function is turned on, the pilot will remain on after the fireplace is turned off. A timer will then begin the countdown for approximately seven (7) days before shutting off the pilot if the appliance is not used. This countdown will reset anytime the burner is used.

If your appliance is equipped with a remote control device capable of selecting IPI / CPI modes, refer to remote operating instructions.

In order to start your pilot, turning the main burner on with the switch, remote or thermostat and then turning it off will reactivate the continuous pilot mode and reset the seven day timer.

A jumper is supplied with this unit that can be plugged into the wire harness connected to the controller. This jumper cable gives the Remote Control the ability to operate the POD / IPI switch and set the unit to operate in either condition. Please refer to jumper installation instructions for more information.

### Remote Continuous Pilot (CPI) Selection

#### Requires installation of the CPI JUMPER

With the system in "off" position press the Mode Key, to index to the CPI mode icon, Pressing the Up Arrow Key will activate the Continuous Pilot Ignition mode (CPI). Pressing the Down Arrow Key will return to IPI. A single "beep" will confirm the reception of the command.

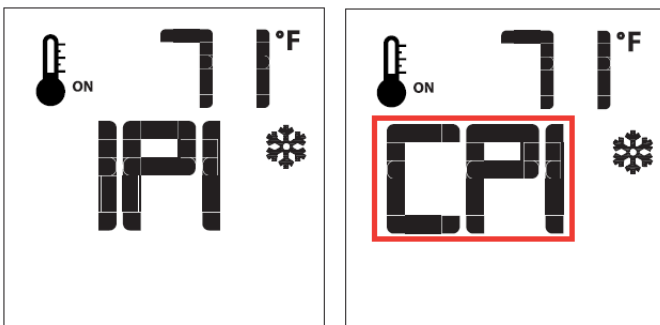

### Installing the CPI Jumper Cable

- 1). Access the control box.

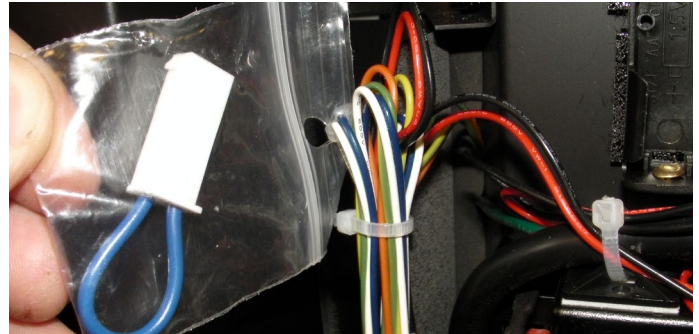

Figure 19.a Open the control box drawer

- 2). Remove the bag containing the Jumper Cable from the wire harness connected to the controller.

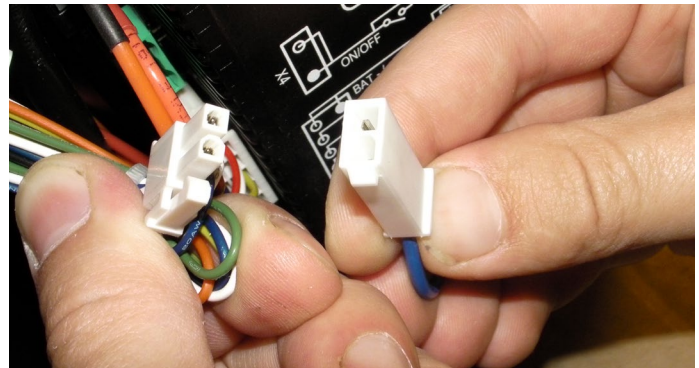

Figure 19.b Locate Jumper cable

- 3). Find the corresponding plug attached to the control wire harness and connect the CPI jumper.

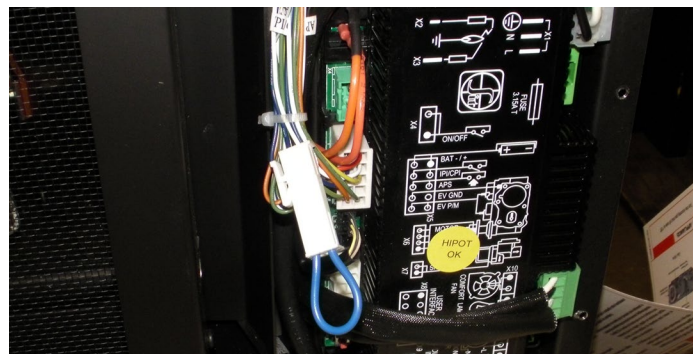
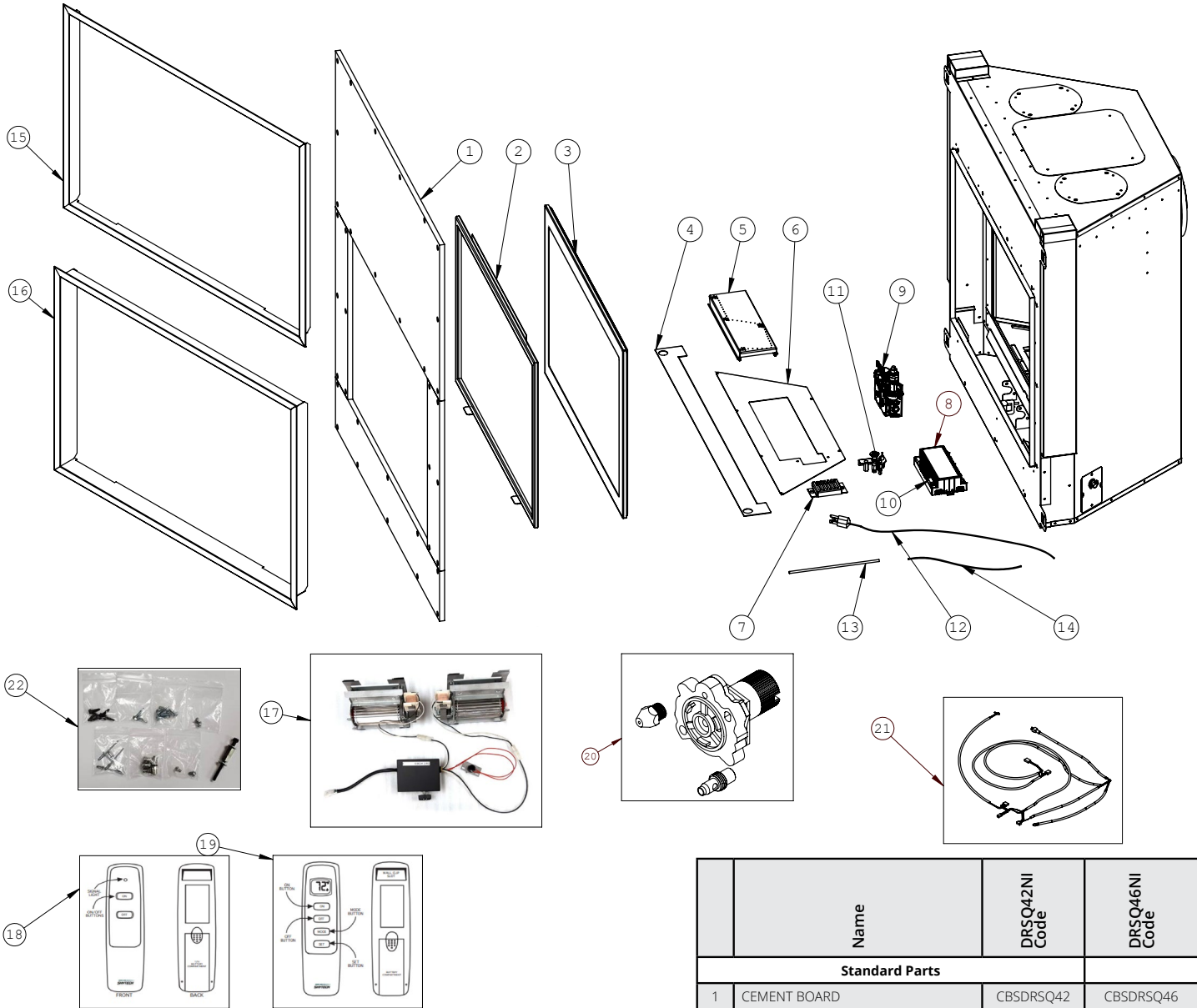

Figure 19.c Connect CPI

- 4). See operation section to turn remote into CPI mode.

## DRSQ\*I BASIC Exploded Parts



	Name	DRSQ42NI Code	DRSQ46NI Code
<b>Optional Parts</b>			
15	ADJUSTABLE TRIM KIT 0-11/16"	DRSQ42	DRSQ46
16	ADJUSTABLE TRIM KIT 1 1/2" - 2"	DRSQ42-2	DRSQ46-2
17	BASIC FAN KIT	DRFK2	DRFK2
18	DELRAY ON/OFF REMOTE	RX40	RX40
19	DELRAY THERMOSTATIC REMOTE	RX60	RX60
20	LP CONVERSION KIT	GCA026	GCA023
21	DELRAY PV WIRE HARNESS	ECA136PV	ECA136PV
22	FASTENER REPAIR KIT	RKIT01	RKIT01

	Name	DRSQ42NI Code	DRSQ46NI Code
<b>Standard Parts</b>			
1	CEMENT BOARD	CBSDRSQ42	CBSDRSQ46
2	SCREEN	RSCDRSQ42	RSCDRSQ46
3	DOOR	RDTDRSQ42	RDTDRSQ46
4	VALVE COVER	RVBDRSQ42	RVBDRSQ46
5	BURNER ASSEMBLY	RBDRSQ42	RBDRSQ46
6	PERFORATED ROCK TRAY	RRTDRSQ42	RRTDRSQ46
7	PILOT COVER	RPCDRSQ	RPCDRSQ
8	PROFLAME 2 BASIC CONTROL BOARD	RGC3094	RGC3094
9	NATURAL GAS VALVE	RGC3044	RGC3044
10	FUSE 3.5A	REC1386	REC1386
11	PILOT	RPA035	RPA035
12	REPLACEMENT POWER HARNESS	RECA131	RECA131
13	PILOT TUBING 24"	RPTA03	RPTA03
14	PROFLAME2 BOARD HARNESS	REC3062	REC3062

## DRSQ\*I-2 FULL LOAD Exploded Parts

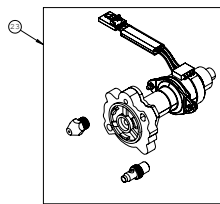
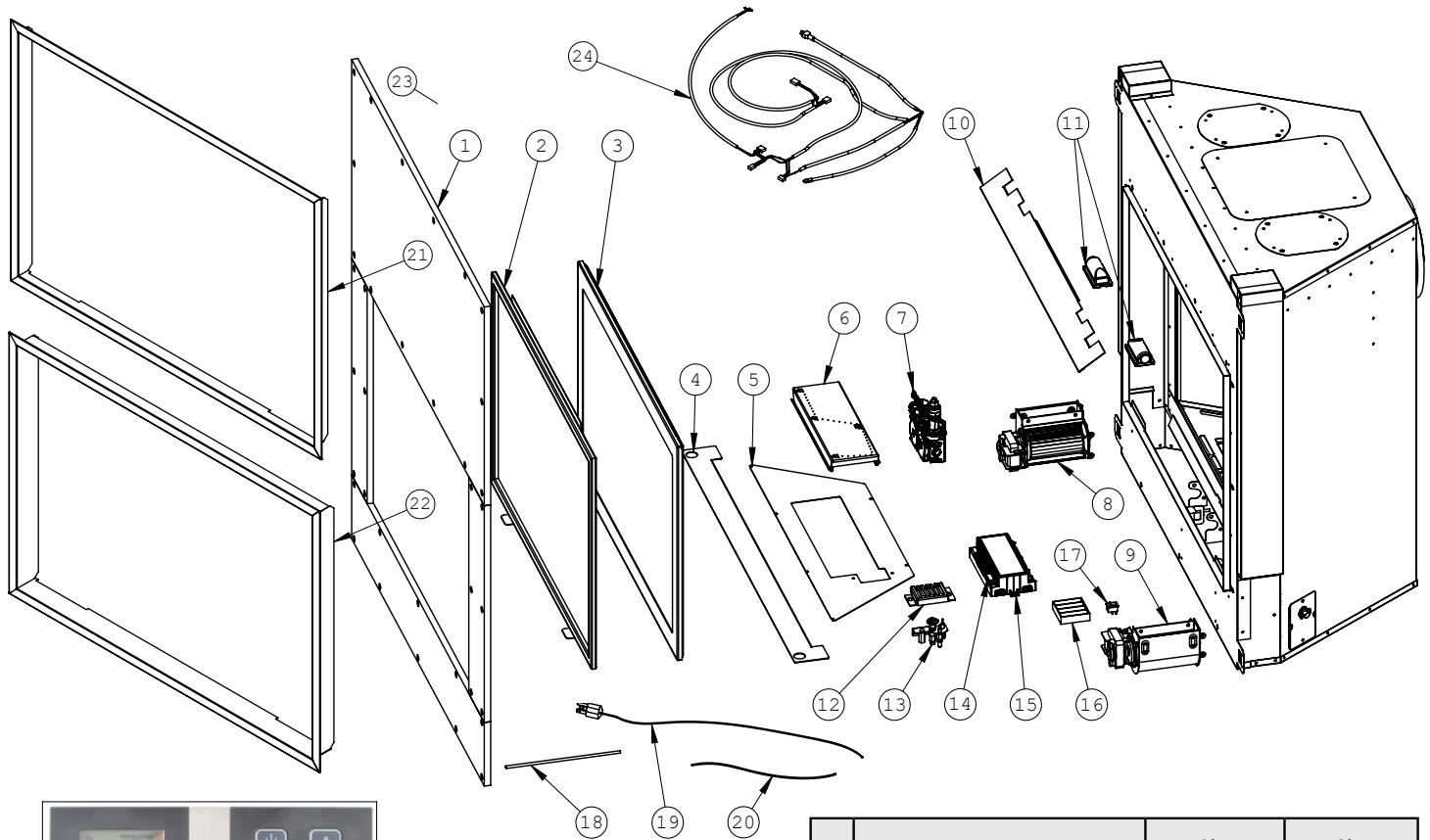

	Name	DRSQ42NI-2 Code	DRSQ46NI-2 Code
<b>Standard Parts</b>			
1	CEMENT BOARD	CBSDRSQ42	CBSDRSQ46
2	SCREEN	RSCDRSQ42	RSCDRSQ46
3	DOOR	RDTDRSQ42	RDTDRSQ46
4	VALVE COVER	RVBDRSQ42	RVBDRSQ46
5	PERFORATED ROCK TRAY	RRTDRSQ42	RRTDRSQ46
6	BURNER ASSEMBLY	RBDRSQ42	RBDRSQ46
7	NATURAL GAS VALVE	RGC3033	RGC3033
8	LEFT FAN ASSEMBLY	REC1377	REC1377
9	RIGHT FAN ASSEMBLY	REC1378	REC1378
10	AIR FLOW BRACKET	RAFBDRSQ42	RAFBDRSQ46
11	REPLACEMENT BULB	REC1546	REC1546
12	PILOT COVER	RPCDRSQ	RPCDRSQ
13	PILOT	RPA035	RPA035
14	FUSE 3.5A	REC1386	REC1386
15	PROFLAME 2 FULL-LOAD BOARD	RGC3095	RGC3095
16	BATTERY HOLDER (4)	AF40BP	AF40BP
17	ON/OFF SWITCH	RECA015	RECA015
18	PILOT TUBING 24"	RPTA03	RPTA03
19	REPLACEMENT POWER HARNESS	RECA131	RECA131
20	PROFLAME2 BOARD HARNESS	REC3062	REC3062

	Name	DRSQ42NI-2 Code	DRSQ46NI-2 Code
<b>Optional Parts</b>			
21	ADJUSTABLE TRIM KIT 0-11/16"	DRSQT42	DRSQT46
22	ADJUSTABLE TRIM KIT 1 1/2" - 2"	DRSQT42-2	DRSQT46-2
23	LP CONVERSION KIT	GCA027	GCA023
24	DELRAY PV WIRE HARNESS	ECA136PV	ECA136PV
25	WALL MOUNT PROFLAME REMOTE	REC1493	REC1493
26	REMOTE CONTROL	RGC3063	RGC3063
27	FASTENER REPAIR KIT	RKIT01	RKIT01

## Indoor fireplace in protected outdoor applications

This fireplace may be installed into outdoor locations provided they are suitably protected from direct water impingement. However, all installation clearances in the appliance manual must be observed. Framing, Clearances to Combustibles, Mantel Heights, Facing Requirements, Venting Installation, etc. Use supplied Safety Screen.

Dimension "A"	X .75	= min. overhang depth
The overhang must extend at least 75% of the roof line height (A) Height is measured from bottom of fireplace opening to the ceiling		

<b>Example formula</b>
Min. overhang = $A \times 0.75$
For example: if distance A is 84", the overhang must extend at least 63"

### See through fireplace

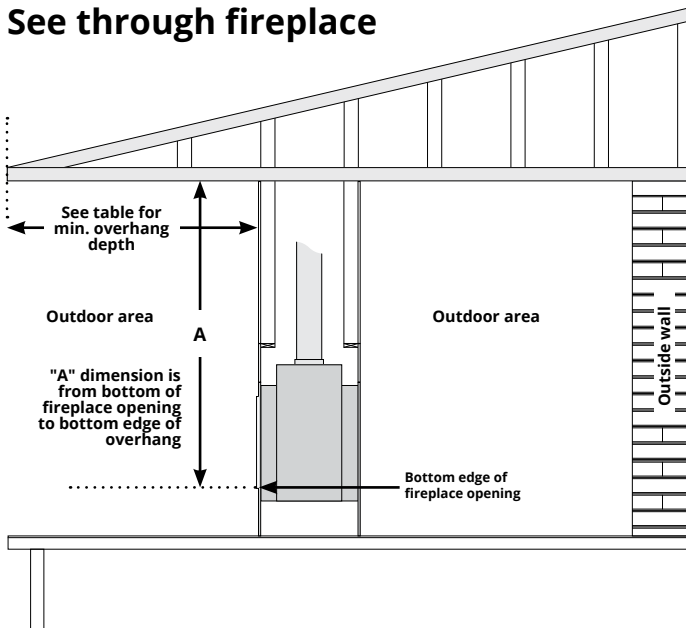

### Single sided fireplace

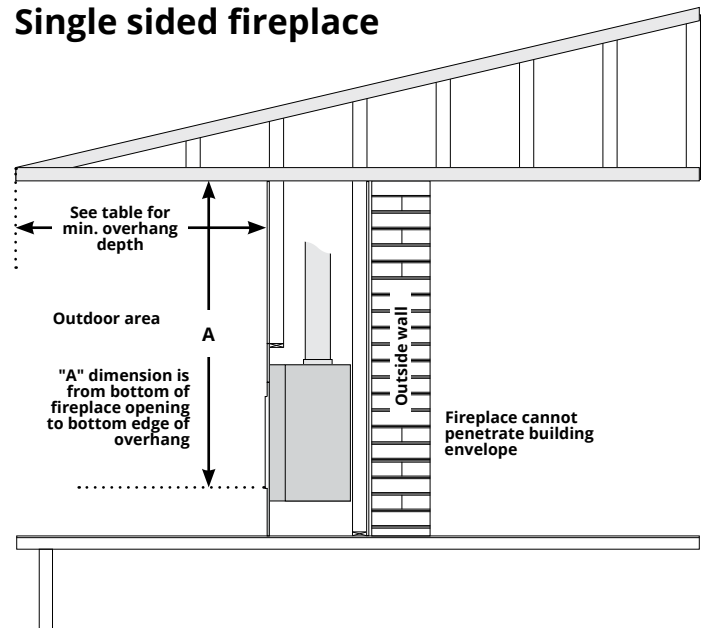

### Notes

- Overhang requirements must be applied to both the front and sides of the fireplace
- Indoor see-through models cannot be installed as indoor/outdoor fireplaces, as air flows through both sides of the fireplace.
- If the fireplace will be in contact with salt water, then an outdoor fireplace is recommended
- Follow all building codes, including those addressing fireplace penetration of an exterior building envelope
- Follow all product installation instructions; including framing, clearances to combustibles, mantel heights, Facing Requirements, venting installation, etc. Use supplied safety screen.
- All wiring connections to line power shall be in accordance with outdoor requirements of; NECA NFPA 70 in the USA Canadian Electrical Code, CSA C22.1 for Canada.
- The Fireplace is not to be operated in temperatures below freezing (0°C | 32°F)

## NOTICE

Units with tempered glass doors are vulnerable to rapid and/or extreme changes in temperature (thermal shock). Take care to prevent water from contacting the fireplace, especially if it is hot.

## Appendix A: Venting Terminations

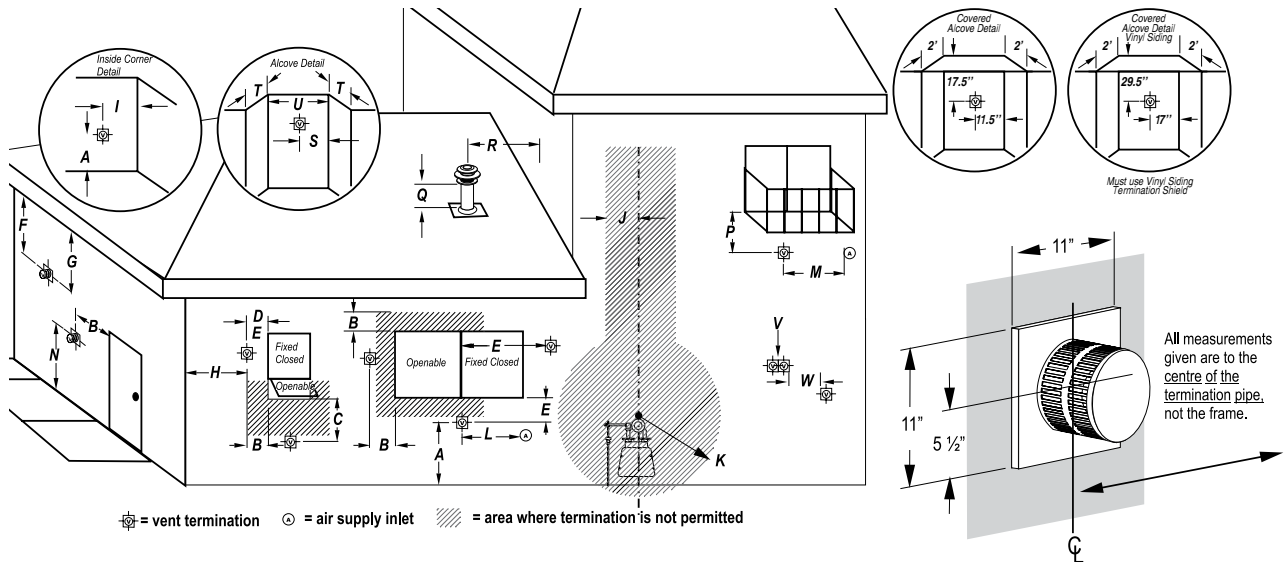

Location	Canada*	USA**	
A	clearance to the termination frame above grade, veranda, porch, deck, or balcony	12 inches	12 inches
B	clearance to top of doors or operable windows	12 inches	12 inches
C	clearance to sides or bottom of door or operable windows	12 inches	9 inches
D	clearance to permanently closed window when installed with approved glass penetration termination	0	0
E	clearance to permanently closed window Recommended to prevent condensation	16 inches	16 inches
F	clearance to ventilated soffit located within a horizontal distance to 24 inches from centerline of termination	24 inches	24 inches
G	clearance to unventilated soffit	30 inches to combustibles 16 inches to non-combustibles	30 inches to combustibles 16 inches to non-combustibles
H	clearance to outside corner	9 inches	9 inches
I	clearance to inside corner	12 inches	12 inches
J	clearance to each side of the vertical centerline of a metre or regulatory assembly to a maximum vertical distance of 15ft	3 feet	3 feet
K	clearance to service regulator vent outlet	3 feet	3 feet
L	clearance to non mechanical air supply inlet to the building or combustion air inlet to other appliance for appliance <= 100,000 BTU/H (30 kW)	12 inches	12 inches
M	clearance to forced air supply inlet	6 feet	3 feet above air inlet
N	clearance above paved sidewalk or paved driveway located on public property	7 feet	7 feet
P	clearance under veranda, porch, deck, or balcony	22 inches to combustibles 16 inches to non-combustibles	22 inches to combustibles 16 inches to non-combustibles
Q	clearance above roof	2 feet	2 feet
R	clearance to adjacent walls and neighboring buildings	2 feet	18 inches
S	clearance from corner in recessed location	12 inches	12 inches
T	Maximum depth of recessed location	4 feet	4 feet
U	Maximum width for back wall of recessed location	2 feet	2 feet
V	Horizontal clearance between two terminations that are level	0	0
W	Horizontal clearance (centre to centre) between two terminations that are not level	18 inches	18 inches

Note 1: For N a vent shall not terminate directly above the sidewalk or paved driveway which is located between two single family dwellings and serve both dwelling.

Note 2: For P only permitted if veranda, porch, deck, or balcony is fully open on a minimum of two sides beneath the floor

Note 3: For J, K, and as specified in CGA B149 installation code. Local codes or regulations may vary.

\* Based on CGA B149.1 Natural Gas and Propane installation code. Local codes may vary, please check with local regulatory agency.

\*\* Based on ANSI Z223.1/NFPA 54 National Fuel Gas Code. Local codes may vary, please check with local regulatory agency.

## Appendix B: Warranty

### MONTIGO RESIDENTIAL WARRANTY PROGRAM

Canadian Heating Products Inc. and/or Montigo DelRay Corp (collectively referred to herein as "The Companies"), warrants the Montigo gas appliance (referred to herein as 'the appliance') to be free from defects in materials and workmanship at the time of manufacture. The gas appliance and related components are further subject to the terms and conditions set forth below.

This warranty covers the following Montigo product series: **Distinction, Divine & Divine Outdoor (H-Series), Illume (FID Inserts), Phenom (L/P/PL-Series), Exemplar (R/RP-Series), Mahana and DelRay**

Component	Coverage Period	Labor Coverage
Firebox, heat exchanger	15 years	1 year
Main burner	15 years	1 year
Gas control valve and related control components (pilot assembly, spark electrode flame sensors, thermopile)	1 year	1 year
Electrical components (internal blowers, ignition control module, wiring, switches, remote control systems, blower control module, accent bulbs)	1 year	1 year
Firebox media (logset, glass beads, river rocks)	1 year	1 year
Glass (thermal breakage)	1 year	1 year
Plated, painted finishes (including interior reflective glass) *	1 year	1 year
Refractory lining	1 year	1 year
Mesh/Glass safety barriers	1 year	1 year
Power vent termination	1 year	1 year
Montigo terminations*	10 years	1 year
Montigo venting (excluding termination)	15 years	1 year

\* Exterior painted surfaces exempt

### QUALIFICATIONS TO THE WARRANTY

This Warranty only covers gas appliances installed in the United States or Canada.

To receive the benefits of this warranty, the appliance must be purchased, installed and serviced annually by a dealer authorized by The Companies for the warranty to be valid.

The gas appliance must be installed by a licensed professional in accordance with The Companies' installation instructions and local building codes. The warranty on the appliance covers only components manufactured by The Companies. The use of components manufactured or supplied by other manufacturers and used in conjunction with the appliance could create serious safety hazards, may result in the denial of certification by recognized national safety agencies and could violate local building codes. Such use may untimely void this warranty. This warranty does not cover any damages occurring from the use of any components not manufactured or supplied by The Companies.

The appliance must be subjected to normal use. The appliance is designed to burn natural gas (NG) or liquefied petroleum (LP) only. Burning conventional fireplace fuels such as wood, coal or any other solid fuel will cause damage to the appliance, produce

excessive temperatures will result in a fire hazard and void all warranties. This warranty is transferable. The appliance must remain in its original place of installation to be valid.

If the components of the appliance covered by this warranty are found to be defective within the time frame stated (see The Companies investigation of claims), The Companies will, at its option, replace or repair defective components of the appliance manufactured by The Companies at no charge and will also pay for labor costs (in accordance with schedule) incurred in replacing or repairing components. If repair or replacement is not commercially practical, The Companies will, at its sole discretion, fully discharge all obligations under the warranty by refunding the verified dealer purchase price of the appliance, excluding the cost of labor unless the labor is covered by the terms of the warranty.

This warranty covers only parts and labor as provided above. In no case shall the companies be responsible for materials, components or construction, which are not manufactured or supplied by The Companies, or for the labor necessary to install, repair or remove such materials, components or construction. All replacement or repair components will be shipped F.O.B. from the nearest Company factory.

### LIMITATION ON LIABILITY

It is agreed and understood that The Companies sole obligation, and purchaser's exclusive remedy under this warranty, under any other warranty, expressed or implied, or in contract, tort or otherwise, shall be limited to repair, replacement or refund as specified above. The opinion of The Companies with respect to these matters shall be final.

In no event shall The Companies be responsible for any incidental or consequential damages caused by (but not limited to) improper installation, installation by an unqualified or unauthorized installer, accident, lack of regular maintenance, user error, abuse, misuse, Acts of God, power surges, floods, natural disasters, force majeure, defects in its appliance whether such damage occurs or is discovered before or after replacement or repair, and whether or not such damage is caused by The Companies negligence. Some jurisdictions do not allow the exclusion or limitation of incidental or consequential damages, so the above limitation or exclusion may not apply to you. The duration of any implied warranty with respect to the appliance is limited to the duration of the foregoing warranty. Some jurisdictions do not allow limitations on how long an implied warranty lasts, so the above limitation or exclusion may not apply to you.

## Appendix B: Warranty Continued

### EXCLUSIONS TO WARRANTY

Corrosion or rust of any kind due to a lack of maintenance, inadequate combustion air or improper venting and corrosive chemicals/environments, expansion and contraction of metals or minor movements of components causing noise are not covered by this warranty.

Willful misconduct (i.e. use of the appliance with problems known to the purchaser and causing further damages), including unauthorized or self-performed 'fixing' or exploration of the appliance's internal workings will void the warranty.

Appliances on which the serial number has been altered, defaced, removed or made illegible will void the warranty.

Costs incurred for diagnosis, service work, shipping and handling of defective or replacement parts are not covered under this warranty.

The published warranties are not applicable for any equipment manufactured by The Companies that has been sold direct to the consumer via internet or auction websites. The Companies do not endorse, approve or certify any online sale of its products through auction websites, online retailers or any other method of online sales direct to consumers.

### INVESTIGATION OF CLAIMS AGAINST WARRANTY

The Companies reserve the right to investigate any and all claims against this warranty and decide upon method of settlement.

The Companies are not responsible for work done without written consent of The Companies.

The Companies shall in no event be responsible for any warranty work done without first obtaining the Companies written consent.

The Companies employees and dealers have no authority to make any warranties to neither alter this warranty nor authorize any remedies in addition to or inconsistent with those stated within this warranty.

### IF WARRANTY SERVICE IS NEEDED

To make a claim under this warranty, contact your installing dealer or contractor. The installing dealer is responsible for providing service and will contact the companies to initiate warranted parts replacements. In the event the installing dealer is unavailable, contact your nearest authorized Montigo dealer ([www.Montigo.com](http://www.Montigo.com)) or contact Montigo direct at [techsupport@montigo.com](mailto:techsupport@montigo.com). Ensure you have your sales receipt and the model and serial number of your appliance.

### DO NOT ATTEMPT TO DO ANY SERVICE WORK YOURSELF

If you cannot locate the installing dealer, or nearest dealer/distributor, you must notify The Companies in writing.

### USA Offices

6955 Salashan Parkway  
Ferndale WA, 98248  
[techsupport@montigo.com](mailto:techsupport@montigo.com)

### Canadian Offices

27342 Gloucester Way  
Langley, BC V4W 4A1  
[techsupport@montigo.com](mailto:techsupport@montigo.com)

The terms and conditions of this warranty may be altered or amended from time to time without prior notice.

**WARRANTY PERIOD:** Warranty coverage begins on the date of original purchase. In the case of new construction, warranty coverage begins on the date of first occupancy of the dwelling or six months after the sale of the product by an independent, authorized Company dealer/ distributor, whichever occurs earlier.



## Appendix C: Amendment

(Gas Fireplace / Equipment sold in the State of Massachusetts)

### 5.08: Modifications to NFPA-54, Chapter 10

- (1) Revise NFPA-54 section 10.5.4.2 by adding a second exception as follows:

Existing chimneys shall be permitted to have their use continued when a gas conversion burner is installed, and shall be equipped with a manually reset device that will automatically shut off the gas to the burner in the event of a sustained back-draft.

- (2) Revise 10.8.3 by adding the following additional requirements:

- (a) For all side wall horizontally vented gas fueled equipment installed in every dwelling, building or structure used in whole or in part for residential purposes, including those owned or operated by the Commonwealth and where the side wall exhaust vent termination is less than seven (7) feet above finished grade in the area of the venting, including but not limited to decks and porches, the following requirements shall be satisfied:

1. **INSTALLATION OF CARBON MONOXIDE DETECTORS.** At the time of installation of the side wall horizontal vented gas fueled equipment, the installing plumber or gas fitter shall observe that a hard wired carbon monoxide detector with an alarm and battery back-up is installed on the floor level where the gas equipment is to be installed. In addition, the installing plumber or gas fitter shall observe that a battery operated or hard wired carbon monoxide detector with an alarm is installed on each additional level of the dwelling, building or structure served by the side wall horizontal vented gas fueled equipment. It shall be the responsibility of the property owner to secure the services of qualified licensed professionals for the installation of hard wired carbon monoxide detectors
  - a. In the event that the side wall horizontally vented gas fueled equipment is installed in a crawl space or an attic, the hard wired carbon monoxide detector with alarm and battery back-up may be installed on the next adjacent floor level.
  - b. In the event that the requirements of this subdivision can not be met at the time of completion of installation, the owner shall have a period of thirty (30) days to comply with the above requirements; provided, however, that during said thirty (30) day period, a battery operated carbon monoxide detector with an alarm shall be installed.
2. **APPROVED CARBON MONOXIDE DETECTORS.** Each carbon monoxide detector as required in accordance with the above provisions shall comply with NFPA 720 and be ANSI/UL 2042 listed and IAS certified.
3. **SIGNAGE.** A metal or plastic identification plate shall be permanently mounted to the exterior of the building at a minimum height of eight (8) feet above grade directly in line with the exhaust vent terminal for the horizontally vented gas fueled heating appliance or equipment. The sign shall read, in print size no less than one-half (1/2) inch in size, "GAS VENT DIRECTLY BELOW. KEEP CLEAR OF ALL OBSTRUCTIONS".

4. **INSPECTION.** The state or local gas inspector of the side wall horizontally vented gas fueled equipment shall not approve the installation unless, upon inspection, the inspector observes carbon monoxide detectors and signage installed in accordance with the provisions of 248 CMR 5.08(2)(a)1 through 4.

- (b) **EXEMPTIONS:** The following equipment is exempt from 248 CMR 5.08(2)(a)1 through 4:

1. The equipment listed in Chapter 10 entitled "Equipment Not Required To Be Vented" in the most current edition of NFPA 54 as adopted by the Board; and
  2. Product Approved side wall horizontally vented gas fueled equipment installed in a room or structure separate from the dwelling, building or structure used in whole or in part for residential purposes.
- (c) **MANUFACTURER REQUIREMENTS - GAS EQUIPMENT VENTING SYSTEM PROVIDED.** When the manufacturer of Product Approved side wall horizontally vented gas equipment provides a venting system design or venting system components with the equipment, the instructions provided by the manufacturer for installation of the equipment and the venting system shall include:
1. Detailed instructions for the installation of the venting system design or the venting system components; and
  2. A complete parts list for the venting system design or venting system.
- (d) **MANUFACTURER REQUIREMENTS - GAS EQUIPMENT VENTING SYSTEM NOT PROVIDED.** When the manufacturer of a Product Approved side wall horizontally vented gas fueled equipment does not provide the parts for venting the flue gases, but identifies "special venting systems", the following requirements shall be satisfied by the manufacturer:
1. The referenced "special venting system" instructions shall be included with the appliance or equipment installation instructions; and
  2. The "special venting systems" shall be Product Approved by the Board, and the instructions for that system shall include a parts list and detailed installation instructions.
- (e) A copy of all installation instructions for all Product Approved side wall horizontally vented gas fueled equipment, all venting instructions, all parts lists for venting instructions, and/or all venting design instructions shall remain with the appliance or equipment at the completion of the installation.

- (3) After NFPA-54 section 10.10.4.2 add a new section 10.10.4.3 as follows:

When more than four gas appliances are to be vented through a common gas vent or common horizontal vent manifold, a plan of the proposed vent installation shall be submitted to the Inspector and the serving gas supplier for review and approval.

Extraction from: Massachusetts Rules and Regulations

5.00: Amendments To 2002 Edition Of ANSI Z223.1-NFPA-54

# DelRay Square

Single Sided Gas Fireplace