

WOODBURNING | Z42 & Z42CD | ALBANY

ZERO CLEARANCE WOOD FIREPLACE

Z42 shown with a Single door and Prairie Design Grills



QUALITY FIREPLACES FOR LIFE.

KOZY  HEAT
FIREPLACES



Albany shown with Keystone Grills

WOODBURNING | Z42 & Z42CD | ALBANY

Grills



Z42CD with Black Grills



Z42 with Mission Design Grills



Z42CD with Prairie Design Grills



Albany with Keystone



Albany with Mission



Albany with Harlequin

WOODBURNING | Z42 & Z42CD | ALBANY

Specifications

Z42

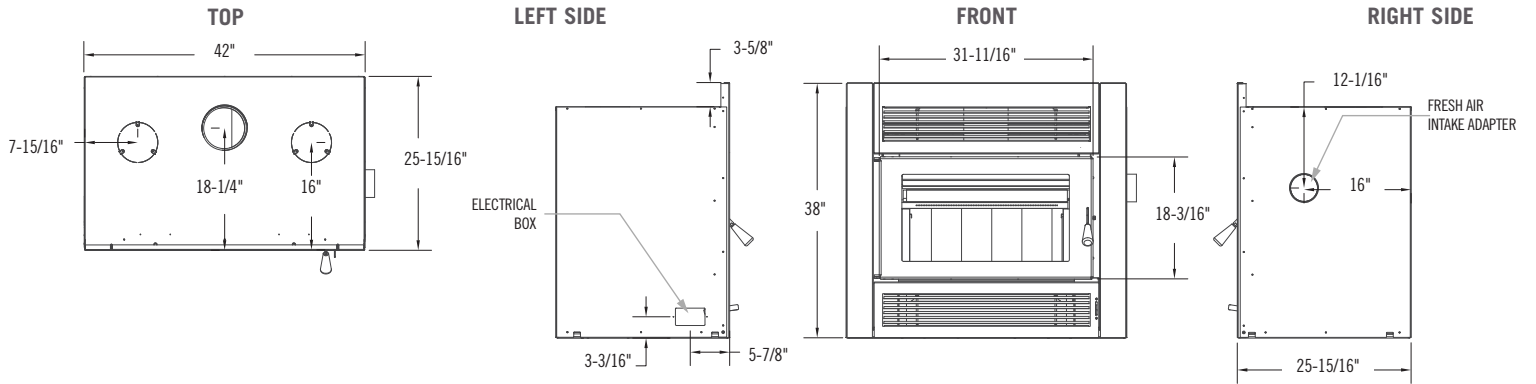

Z42CD (CAST DOORS)

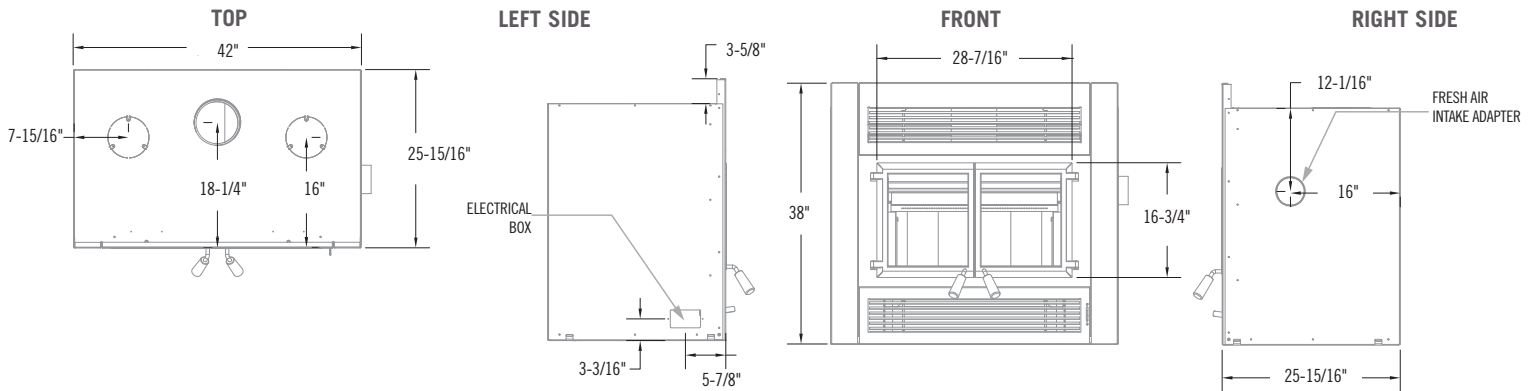

ALBANY

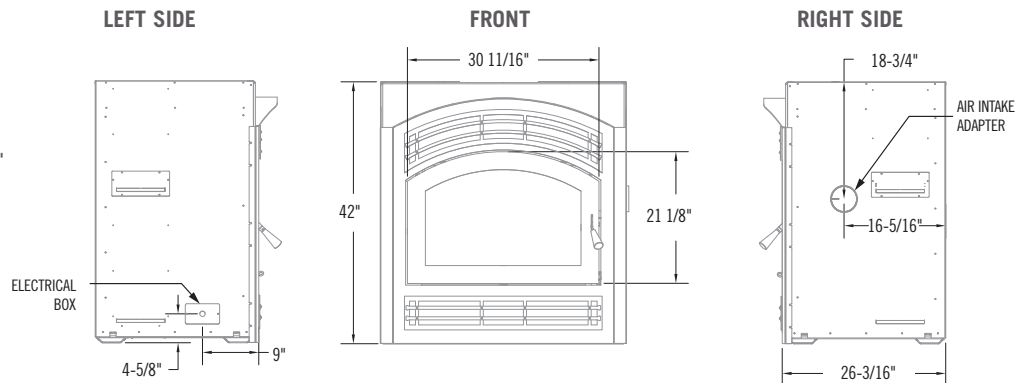

WOODBURNING | Z42 & Z42CD | ALBANY

Fireplace brochures are for advertising purposes only. Refer to the specific fireplace manual for installation.

Specifications

For a wood-fired hearth that's a 'home anywhere', look no further than Kozy Heat's wood burning EPA Certified fireplaces. Kozy Heat's Non-Catalytic fireplaces decreases flammable creosote within the chimney and burns less fuel. The end result is a clean burn, more warmth with less wood. So relax, kick back and enjoy the flames, knowing you've done your part, not just for the environment, but for your fuel budget.

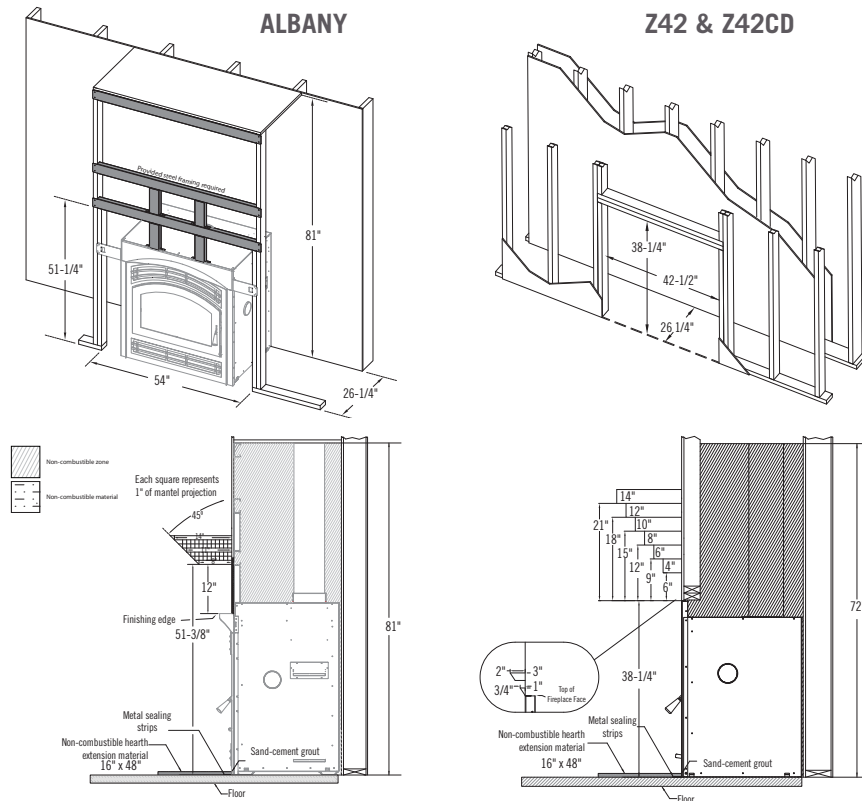

Features

- Large burning area - fits up to 22" logs
- 20 year limited warranty
- Air-wash system (keeps viewing area cleaner)*
- *Although the air wash system assists in keeping the glass cleaner, regular cleaning and maintenance are required.
- Adjustable fresh air intake

Certification & Safety

- EPA NSPS Phase 2 Certified
- U.S. ENVIRONMENTAL PROTECTION AGENCY Certified to comply with 2020 particulate emission standards using cord wood.
- UL 127-2015 (R2016) and Can/ULC S610-87 Safety Standards for U.S. and Canadian installations.
- Approved with all UL 103 HT or CAN/ULC S629 - 6" Insulated Chimney Systems
- Non-catalytic
- Sealed combustion chamber
- Uses 100% outside air for combustion
- High quality pyro-ceram glass
- Tested by PFS®

Clearances

Model	Z42	Z42CD	Albany
Height	38"	38"	42"
Width	42"	42"	39-3/8"
Depth	25-15/16"	25-15/16"	25-11/16"
Weight	525 lbs.	525 lbs.	645 lbs.
Firebox	3.0 cu. ft.	3.0 cu. ft.	3.0 cu. ft.
Glass Size	Single Door: 25"x13"	Dual Cast Door: 11.5" x 13.5" per door	15-1/2" T X 25" W
Optimum Efficiency*	73.32%	73.32%	73.32%
Efficiency	LHV: 70.6%/HHV: 66%	LHV: 70.6%/HHV: 66%	LHV 70.6%/ HHV 66%
EPA Emissions Rate	1.22 g/hr	1.22 g/hr	1.22 g/hr
Peak BTU Output	49,133 BTU/hr	49,133 BTU/hr	49,133 BTU/hr
EPA BTU Output	36,231 – 12,850 BTU/hr	36,231 – 12,850 BTU/hr	36,231 – 12,850 BTU/hr
Air-Seal Doors	10 ga. steel	Dual Cast Doors	10 ga. steel
Decorative Grills	Required	Required	Required
Fan Kit	Optional	Optional	Optional
Heat Duct Kit(s)	Optional	Optional	Optional

Model	Z42 & Z42CD	Albany
Within Enclosure Area:		
Unit to back wall	0"	0"
Appliance to side wall	0"	N/A
Appliance left and right stand-off brackets	N/A	0"
Minimum height of fireplace enclosure from the fireplace base	72"	81"
Exposed Area:		
Wallboard to faceplate top edge/sides	0"	N/A
Fuel door opening to sidewall	8"	N/A
Finishing edge to sidewall:	N/A	12"
Front of fireplace	36"	36"
Top of fireplace to an 8" mantel	12"	12"

Refer to the installation manuals for complete installation & venting requirements. See additional mantel clearance configurations in the installation manual.

*Optimum efficiency is calculated using the medium fire test burn data, BTU content of the cordwood, and the best case moisture content of the cordwood.

Burn Video



Z42

Albany

Features, Options & Specifications are subject to change.

In order to continually provide the highest quality product available, features/options, specifications & dimensions are subject to change. Refer to the unit installation manual for complete installation instructions. Installation must conform with local building codes. **In some regions it may be possible that this appliance qualifies for an energy rebate. See your local dealer for details regarding promotions and qualifications.**

Manufactured by Husson Mfg. Co., Inc.
204 Industrial Park Road, Lakefield, MN 56150
Phone 1-800-253-4904 www.kozyheat.com

10-20



Product Line:



For complete information on the Kozy Heat product line, please contact us at:

FOR CALIFORNIA RESIDENTS ONLY

⚠ California Proposition 65 Warning

WARNING: This product can expose you to chemicals including Carbon Monoxide, that is an externally vented by-product of fuel combustion, which is [are] known to the State of California to cause birth defects or other reproductive harm. For more information, visit www.P65Warnings.ca.gov.