

Please leave these reference guides at the installation location until the installation is finished. See owners manual for full installation and finishing instructions before making final decisions as information is subject to change.

Specifications (all measurements are in inches)

• GAS LINE OPENING: LEFT SIDE • ELECTRICAL ACCESS: RIGHT SIDE

Model	BTU	Height		Front Width		Back Width		Depth		Glass Viewing Area
		Actual	Framing	Actual	Framing	Actual	Framing	Actual	Framing	
CLW-40	31,500	39-1/4	60	49-1/2	56-1/2	49-1/2	56-1/2	18-15/16	22	40 x 13

Framing Opening *If installing the Komfort Zone Kit or Heat Transfer Kit(s), please refer to the installation manual included with the corresponding kit*

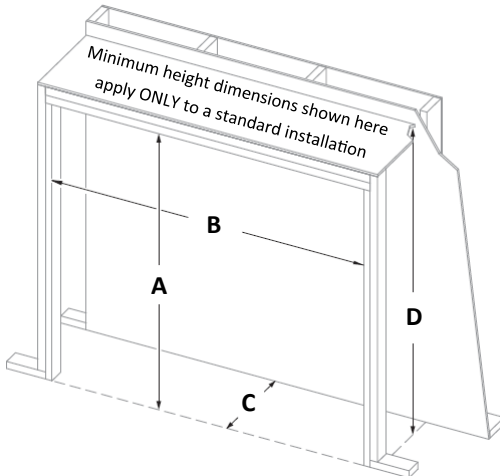

See the KZK-044 or KZK-158A manuals or Vented Cavity Installation (in the install manual) for their specific minimum dimension requirements

Dimension	CLW-40
A	57
B	56-1/2
C	22
D	60

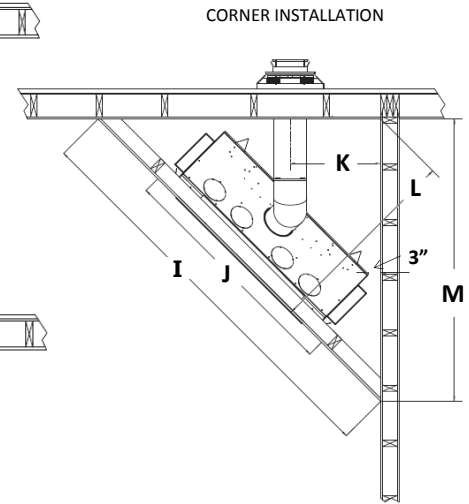
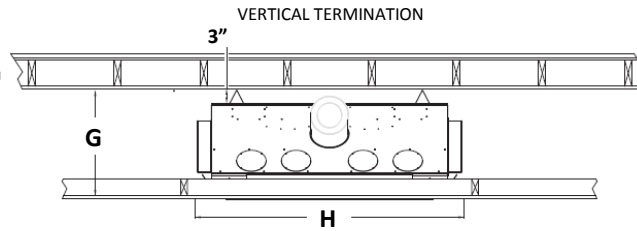
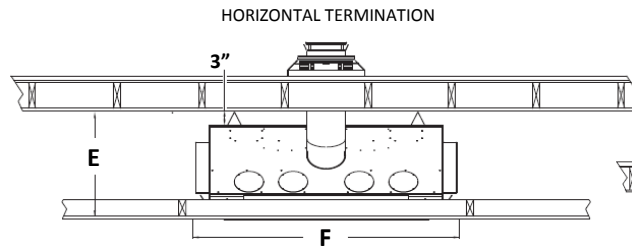

E	F	G	H	I	J	K	L	M
22	56-1/2	22	56-1/2	97-1/2	56-1/2	22	48-3/4	69

Finishing Clearances

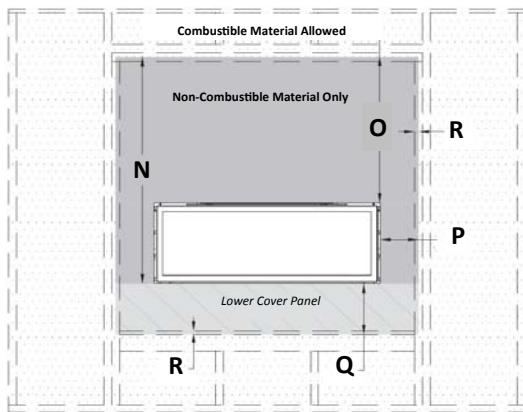

Clearances are for STANDARD installation ONLY

Dimension	CLW-40
N	47-7/8
O	31-1/8
P	7-3/8
Q	10-1/2
R	3/4

- Non-Combustible Material Only
- Combustible Material Allowed
- Combustible Material Allowed*

*See install manual for acceptable screw location usage

Horizontal Termination Framing

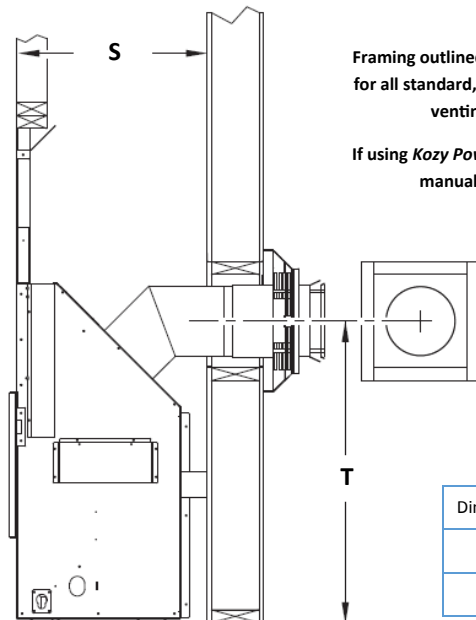

Framing outlined here applies to the minimum for all standard, KZK and vented options when venting with natural draft.

If using Kozy Power Vent (#KPV), reference the manual included with the kit.

Dimension	CLW-40
S	22
T	34-7/8

Mantel Clearances - Standard Installation (NO optional Komfort Zone Heat Distribution Kit)

NON-COMBUSTIBLE ZONE

No optional Decorative Surround

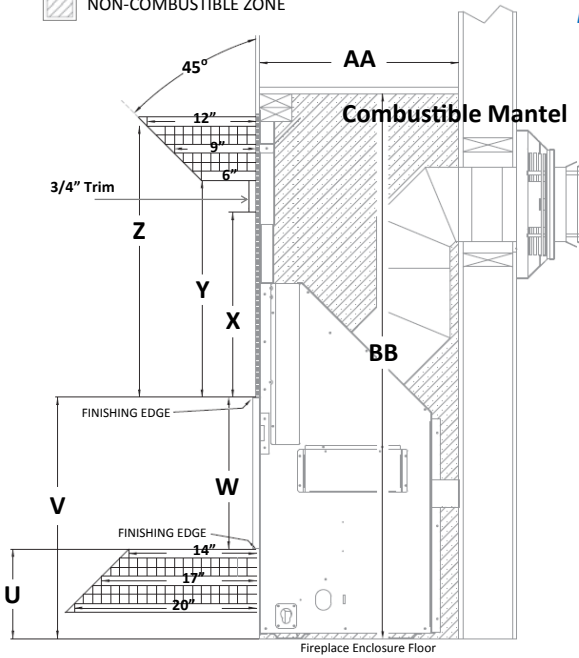

MANTLE PROJECTION:
Each square represents 1"
of projection

Dimension	CLW-40
U	9-7/8
V	26-5/8
W	16-3/4
X	20-3/8
Y	23-7/8
Z	29-7/8
AA	22
BB	60

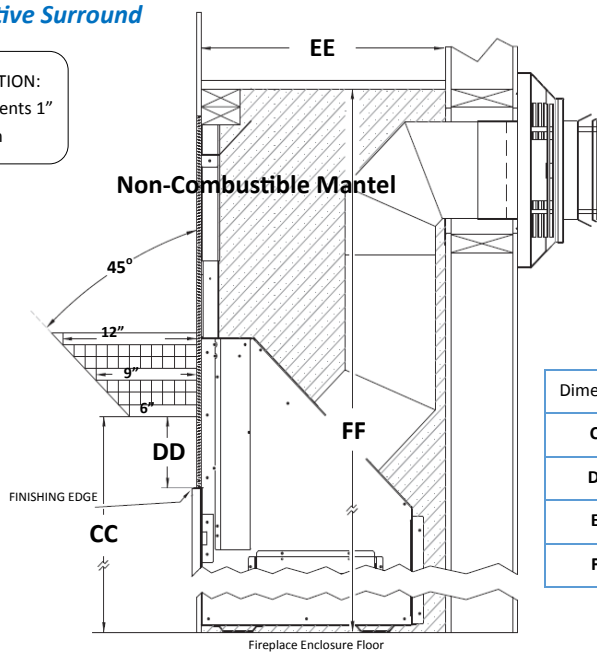

Dimension	CLW-40
CC	32-5/8
DD	6
EE	22
FF	60

Mantel & Hearth Clearances - Komfort Zone Kit Installed (#KZK-158A or #KZK-044)

NO OPTIONAL SURROUND

Combustible wall finish may be installed over cement board and butt up to the finishing edge around the opening

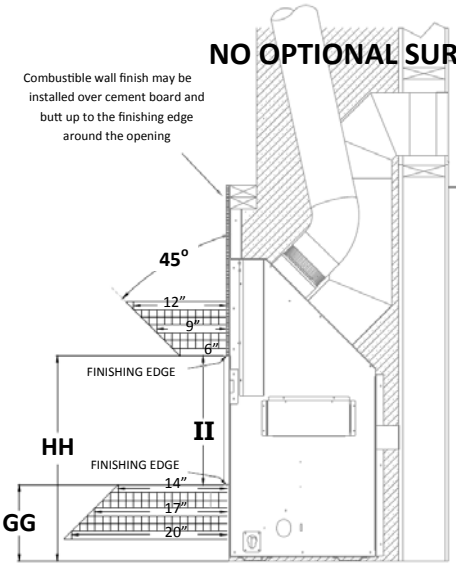

Each square represents 1"
of projection

Dimension	CLW-40
GG	9-7/8
HH	26-5/8
II	16-3/4

Below shows where to end masonry finishing materials, when measuring from the finishing edge. This allows the installation of an Optional Surround. This is important, due to the fact that most masonry finishing materials will not fit behind the optional surround if one is installed.

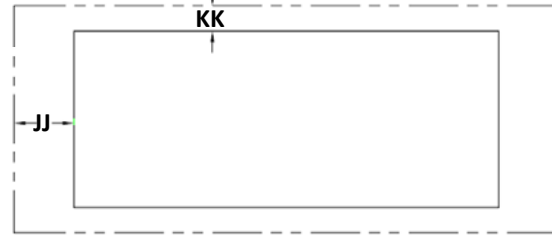

Surround	JJ	KK
CW40-RS	1-1/2	1-1/2
CW40-RS4	2-5/8	2-5/8
CW40-GS	6	2-5/8
CW40-FS	3-1/8	3-1/8

- Measurement 'JJ' shows the space to leave on each side
- Measurement 'KK' shows the space to leave on the top and the bottom

Minimum Horizontal NATURAL DRAFT Venting Requirements

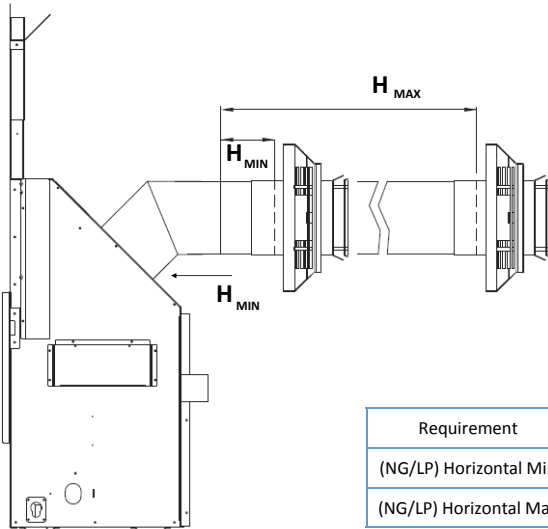

Consult venting chart in the manual for all options above minimum requirements

H = Horizontal
V = Vertical

Requirement	CLW-40
(NG/LP) Horizontal Min	45° Elbow + 9"
(NG/LP) Horizontal Max	24"

Minimum Vertical NATURAL DRAFT Venting Requirements

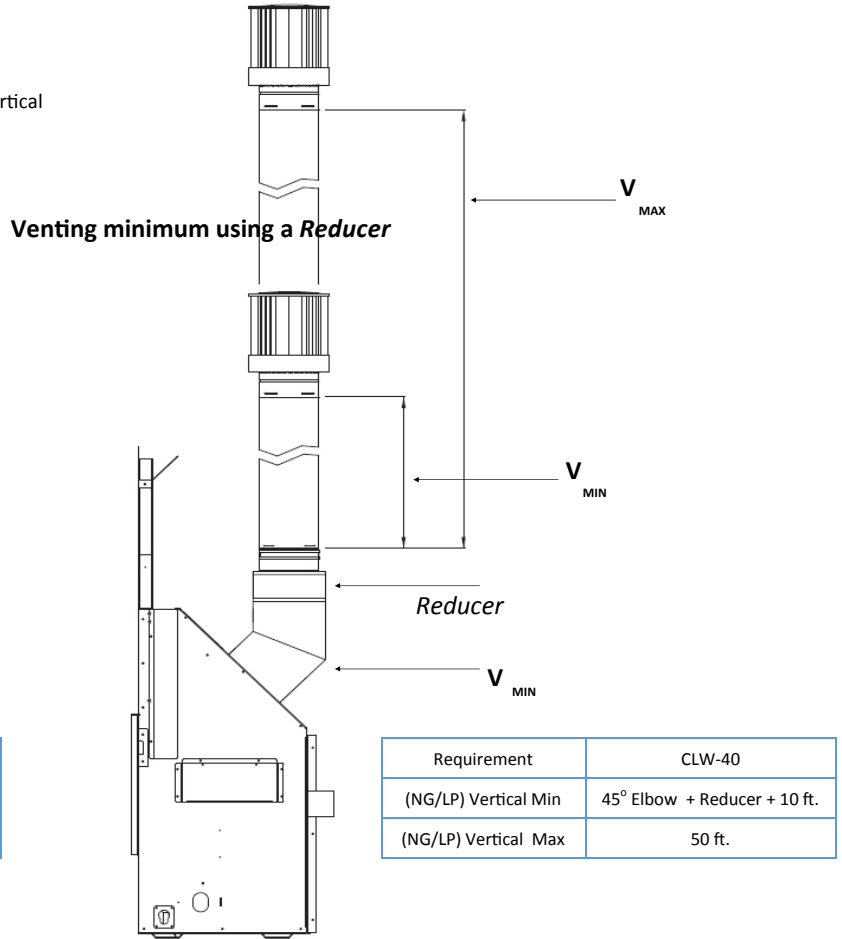
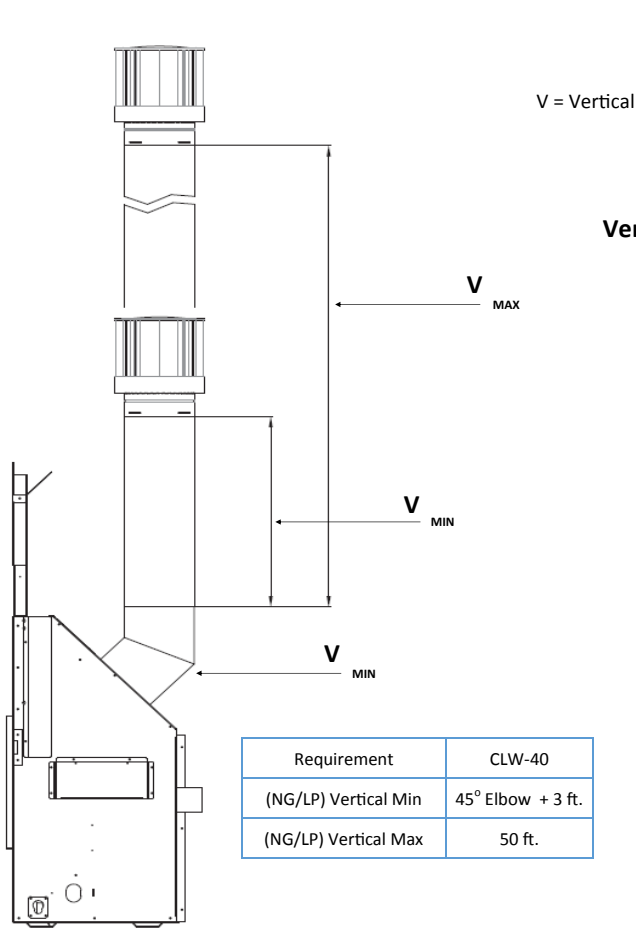

Class 'A' Chimney Conversion Venting

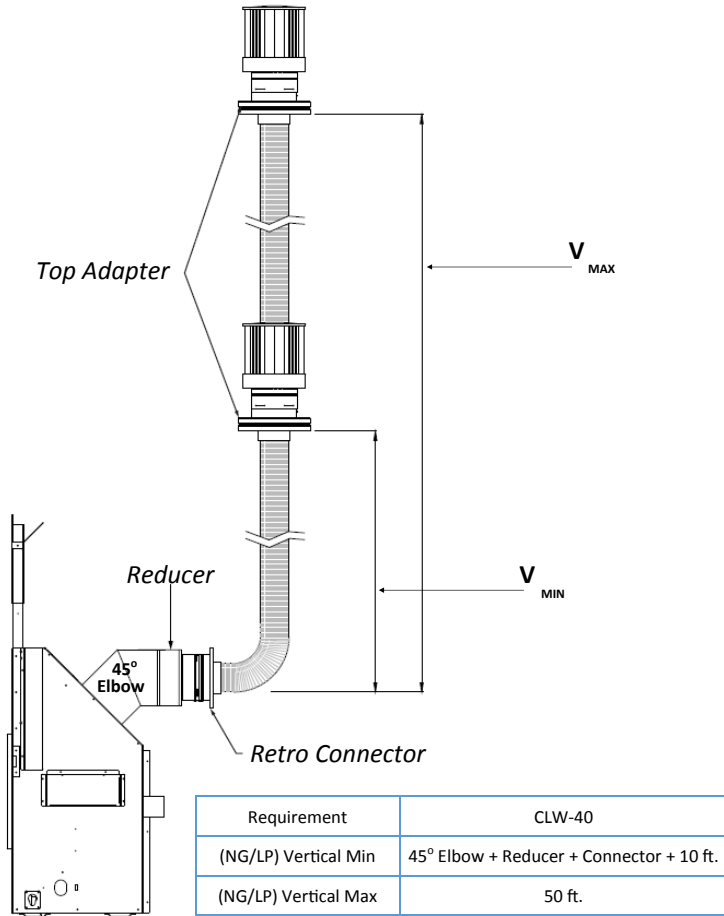

Coaxial to Co-Linear Chimney Venting

