



INSTALLATION / OWNER'S MANUAL TRADITIONAL XTRASLIM SERIES

TRD-26 XTRASLIM

TRD-30 XTRASLIM

TRD-33 XTRASLIM



SAFETY INFORMATION



WARNING

If the information in these instructions are not followed exactly, a fire or explosion may result causing property damage, personal injury or loss of life.

Do not store or use gasoline or other flammable vapors and liquids in the vicinity of this or any other

INSTALLER: LEAVE THIS MANUAL WITH THE APPLIANCE.

CONSUMER: RETAIN THIS MANUAL FOR FUTURE REFERENCE.



WARNING: This product can expose you to chemicals including Lead in the wiring, which is [are] known to the State of California to cause birth defects or other reproductive harm. For more information visit: www.p65warnings.ca.gov

TABLE OF CONTENTS

Please read and carefully follow all of the instruction found in this manual. The instructions included here will assure that you have many years of dependable and enjoyable service from your Amantii Electric Fireplace.

IMPORTANT INSTRUCTIONS	3
UNPACKING AND TESTING THE APPLIANCE	6
GROUNDING THE APPLIANCE	6
LOCATING THE FIREPLACE.....	6
TRD-26 XTRASLIM	7
TRD-30 XTRASLIM	8
TRD-33 XTRASLIM.....	9
BUILT IN INSTALLATION	10
HARDWIRE INSTALLATION	14
MEDIA OPTIONS.....	16
DECORATIVE MEDIA INSTALLATION.....	16
OPERATION.....	17
MANUAL OPERATION	17
REMOTE CONTROL OPERATION.....	18
WIFI OPERATION.....	21
INSTALLING WALL THERMOSTAT	24
REPLACEMENT PARTS.....	25
EXPLODED VIEW	26
TROUBLE SHOOTING.....	27
SERVICE HISTORY.....	28
WARRANTY	29

IMPORTANT INSTRUCTIONS

1. Read all instructions before installing or using this heater.
2. Keep combustible materials, such as furniture, pillows, bedding, papers, clothes and curtains at least 3 feet from the front, sides and rear of the heater.
3. Always unplug heater when not in use.
4. Do not operate the fireplace if it has a damaged cord or plug, after it has malfunctioned, or if the unit has been dropped or damaged in any way.
5. Do not use the heater outdoors.
6. Do not run the cord under carpeting. Do not cover the cord with throw rugs, runners or anything else. Arrange the cord away from traffic areas where it could not be tripped over.
7. To disconnect the heater, turn the controls to "OFF" before removing the plug from the outlet.
8. Do not insert or allow foreign objects to enter any ventilation or exhaust opening, as this may cause an electric shock, fire or damage to the heater.
9. To prevent the possibility of fire, do not block air intakes in any manner.
10. A heater has hot and arcing or sparking parts inside. Do not use it in areas where gasoline, paint or flammable liquids are used or stored.
11. Use this heater only as described in this manual. Any other use is not recommended by the manufacturer, as it may cause fire, electric shock or injury.
12. Avoid the use of an extension cord, the extension cord will overheat and cause a fire.
13. Always use properly grounded fused and polarized outlets.
14. Always use ground fault protection where it is required by electrical codes.
15. Always disconnect the power before performing any cleaning, maintenance or relocation of the heater.
16. To prevent a possible fire, do not burn wood or other materials in this heater.
17. To prevent electric shock or fire, always use a certified electrician, should new circuits or outlets be required.
18. When transporting or storing the heater, keep it in a dry place, free from excessive vibration.
19. This appliance should not be modified under any circumstances.
20. Packaging material should be kept away from children and be disposed of in a safe manner. Plastic bags are not toys and should be kept away from children and infants.

21. Do not use this heater in small rooms when they are occupied by persons not capable of leaving the room on their own, unless constant supervision is provided.
22. If the glass is damaged, do not use the heater to avoid a hazard.
23. Do not leave children unsupervised when the heater is turned on.

Cautions

Do's	<ul style="list-style-type: none"> Always install the heater in accordance with this guide. If in doubt obtain expert advice.
	<ul style="list-style-type: none"> Always make sure the electrical socket is accessible and located adjacent to, but not above the heater.
	<ul style="list-style-type: none"> Always disconnect the heater from the electrical supply before moving it, or carrying out cleaning, maintenance.
	<ul style="list-style-type: none"> Always make sure the heater is firmly secured to prevent it from being tipped over.
	<ul style="list-style-type: none"> Always use a fireguard when young children and infirm persons can come into contact with the heater.
Don'ts	<ul style="list-style-type: none"> Never leave children unsupervised in a room where the heater is ON and unguarded.
	<ul style="list-style-type: none"> Never obstruct or cover the fan outlet or force items into heater openings.
	<ul style="list-style-type: none"> Never install or use the heater anywhere where water is in use, for example: bathrooms, kitchens, or swimming pools.
	<ul style="list-style-type: none"> Never use aerosols or steam cleaners on or around the heater.
	<ul style="list-style-type: none"> Never route the mains supply cable under carpet etc.
	<ul style="list-style-type: none"> Never install the heater close to curtains or combustible materials.
	<ul style="list-style-type: none"> Never use the heater to dry clothes etc.
<ul style="list-style-type: none"> Never sit or stand on the heater. 	

UNPACKING AND TESTING APPLIANCE

Carefully remove the appliance from the box.

Prior to installing the appliance, test to make sure the appliance operates properly by plugging the power supply cord into a 120 Volt grounded outlet.

Test all aspects of its operation (manual switches, remote and heater) to make sure all components are operating correctly.

As with most electronic devices, your new electric fireplace has been designed to operate at temperatures between 5 °C (41°F) and 35 °C (95°F). During the cold winter months, allow the fireplace to reach room temperature before turning it on.

NOTE: There may be traces of odor during the first few minutes of initial use. This is harmless and normal and will never occur again.

GROUNDING APPLIANCE

This appliance is for use on 120 Volts. The cord has a plug as shown in (A). An adapter as shown in (C) is available for connecting three-blade grounding type plugs to two-slot receptacles. The green grounding lug extending from the adapter must be connected to a permanent ground such as a properly grounded outlet box. The adapter should not be used if a three-slot grounded receptacle is available.

To disconnect appliance, turn controls to off, then remove plug from outlet.

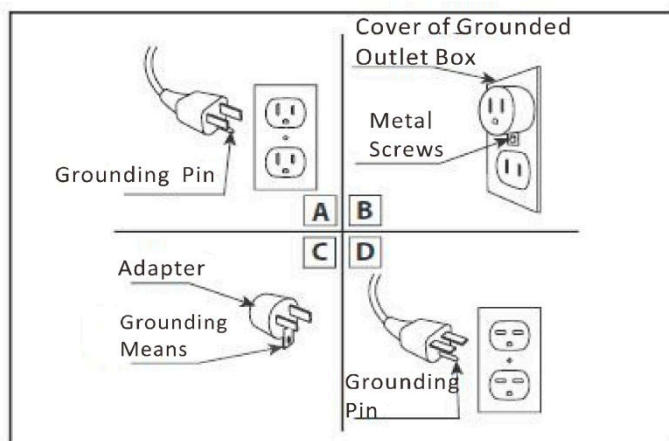

LOCATING THE FIREPLACE

Plan where to locate and frame the fireplace. This will save time and money later when you install the fireplace. Before installation consider the following:

1. Where the fireplace is located must allow for wall and ceiling clearances
2. Consider a location where the fireplace screen will not be exposed to direct sunlight from windows or doors.
3. A 15 ampere, 120 Volt, 60 Hz branch circuit with proper ground must be available at the location. Preferably a dedicated branch circuit should be provided to avoid circuit breakers to trip or fuses to blow.

TRD-26 XTRASLIM

Description	Built-in Appliance
Voltage	120V AC 60Hz
Watts	1465W Max
NO HEATER	15W
MOTOR HEATER	19W
Appliance Width	25 1/4" or 64.16 cm
Appliance Height	16 3/4 " or 42.58 cm
Appliance Depth	4 1/8" or 10.4 cm
Gross Weight	33.07 lbs or 15 kgs
Plug Location	Left side
Cord Length	70 7/8" or 180 cm
Rough Wall Opening Size	25 1/2"× 17" or 64.77 cm× 43.18 cm
BTU	5000

This appliance has been tested in accordance with the UL Standard 2021 for fixed and location dedicated electric room appliances in the United States and Canada. If you need assistance during installation, please contact your local dealer.

NOTE: This appliance must be electrically wired and grounded in accordance with local codes. In the absence of local codes, use the current CSA C22.1 Canadian Electrical Code in Canada or the ANSI/NFPA 70 National Electrical Code in the United States.

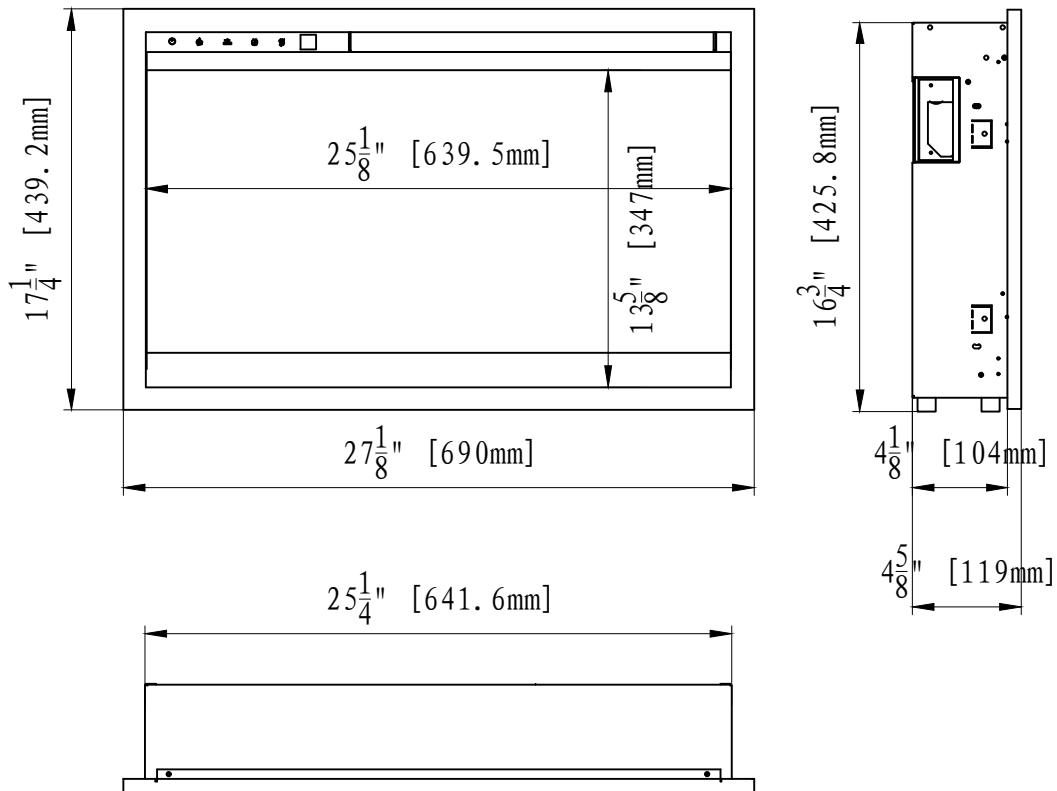

TRD-30 XTRASLIM

Description	Built-in Appliance
Voltage	120V AC 60Hz
Watts	1465W Max
NO HEATER	16W
MOTOR HEATER	19W
Appliance Width	29 3/8" or 74.66 cm
Appliance Height	19 1/8 " or 48.58 cm
Appliance Depth	4 1/8" or 10.4 cm
Gross Weight	39.68 lbs or 18 kgs
Plug Location	Left side
Cord Length	70 7/8" or 180 cm
Rough Wall Opening Size	29 5/8"× 19 3/8" or 75.248 cm× 49.213 cm
BTU	5000

This appliance has been tested in accordance with the UL Standard 2021 for fixed and location dedicated electric room appliances in the United States and Canada. If you need assistance during installation, please contact your local dealer.

NOTE: This appliance must be electrically wired and grounded in accordance with local codes. In the absence of local codes, use the current CSA C22.1 Canadian Electrical Code in Canada or the ANSI/NFPA 70 National Electrical Code in the United States.

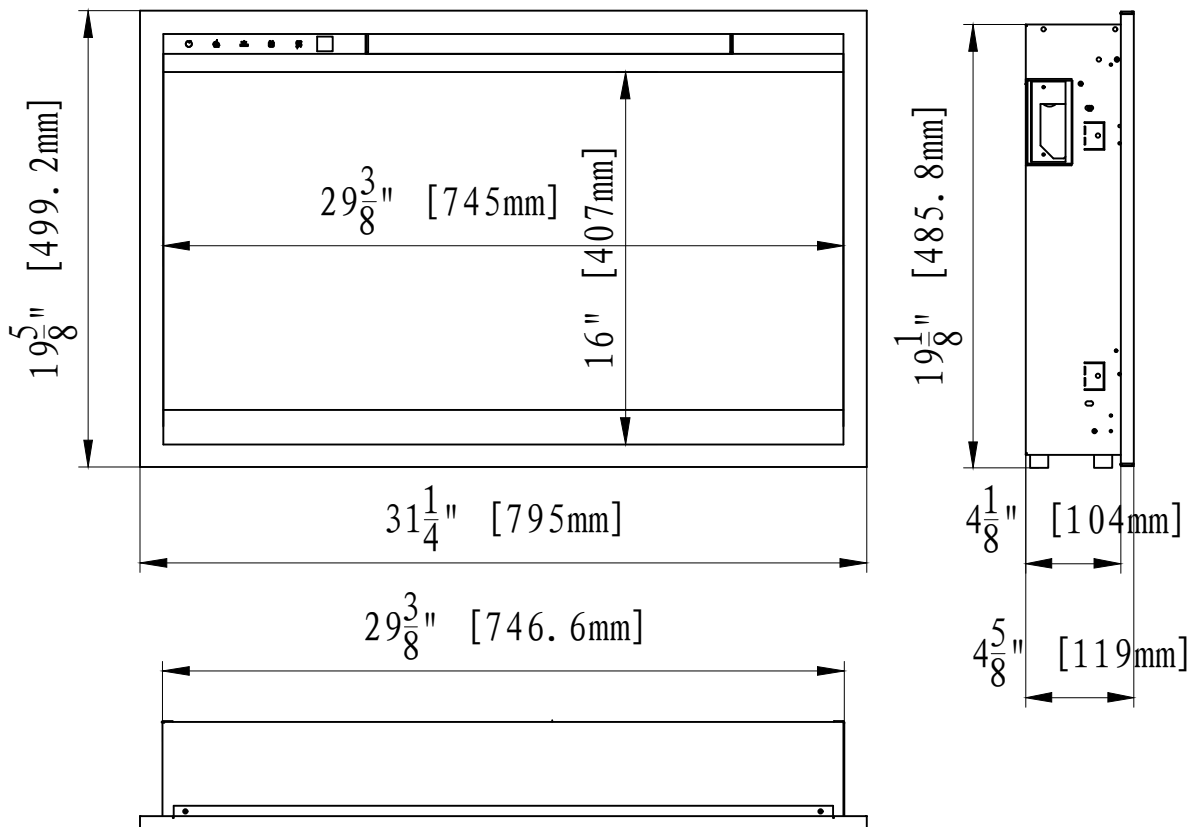

TRD-33 XTRASLIM

Description	Built-in Appliance
Voltage	120V AC 60Hz
Watts	1465W Max
NO HEATER	17W
MOTOR HEATER	19W
Appliance Width	31 3/4" or 80.66 cm
Appliance Height	22 1/4 " or 56.58 cm
Appliance Depth	4 1/8" or 10.4 cm
Gross Weight	47.39 lbs or 21.5 kgs
Plug Location	Left side
Cord Length	70 7/8" or 180 cm
Rough Wall Opening Size	32"× 22 1/2" or 81.28 cm× 57.15 cm
BTU	5000

This appliance has been tested in accordance with the UL Standard 2021 for fixed and location dedicated electric room appliances in the United States and Canada. If you need assistance during installation, please contact your local dealer.

NOTE: This appliance must be electrically wired and grounded in accordance with local codes. In the absence of local codes, use the current CSA C22.1 Canadian Electrical Code in Canada or the ANSI/NFPA 70 National Electrical Code in the United States.

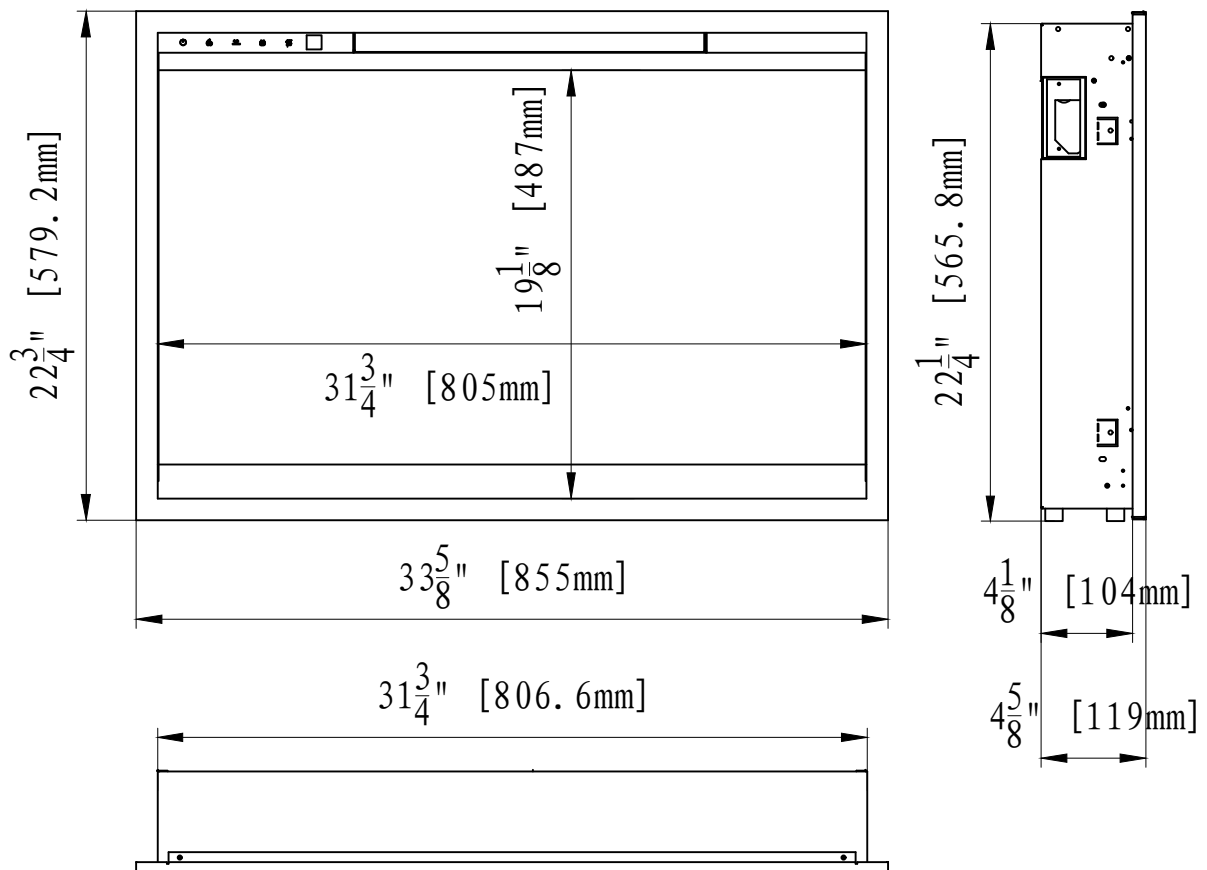

INSTALLATION- BUILT-IN

NOTE: Due to the many different materials used to build walls, it is highly recommended that you consult your local builder before you install this appliance on a wall.

Preparation

1. Select a location that is not prone to moisture and is located at least 0.91m or 3 feet away from combustible materials such as curtains, drapes, furniture, bedding, paper, etc.
2. Mark the desired location on the floor and store the appliance in a safe, dry and dust free place.
3. Prepare a wall with a framed opening to accommodate the size of your unit. Leave at least 1/4" (6mm) around the edge of the appliance. Any new wiring must be done in compliance with local and national codes and other applicable regulations.

Prior to installing, test the appliance to make sure the appliance is fully operational by plugging the power supply cord into a 120 Volt grounded outlet.

The rough wall opening size of the fireplace:

	W(“)	D(“)	H(“)
TRD-26 XTRASLIM	25 1/2	4 3/8	17
TRD-30 XTRASLIM	29 5/8	4 3/8	19 3/8
TRD-33 XTRASLIM	32	4 3/8	22 1/2

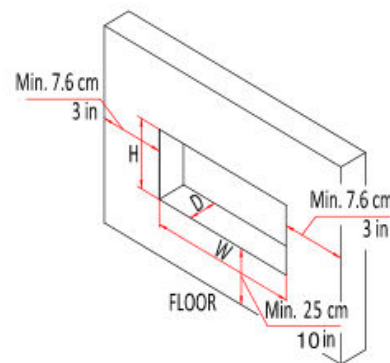

INSTALLATION

1. Take off the steel bar at the outlet of the heater which is fixed with magnetic stones.

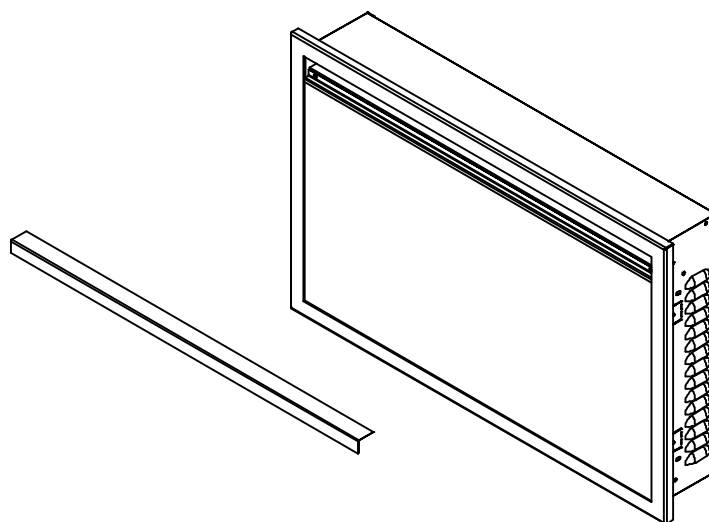

2. Unscrew the screws to take off the front glass fixing steel bar.

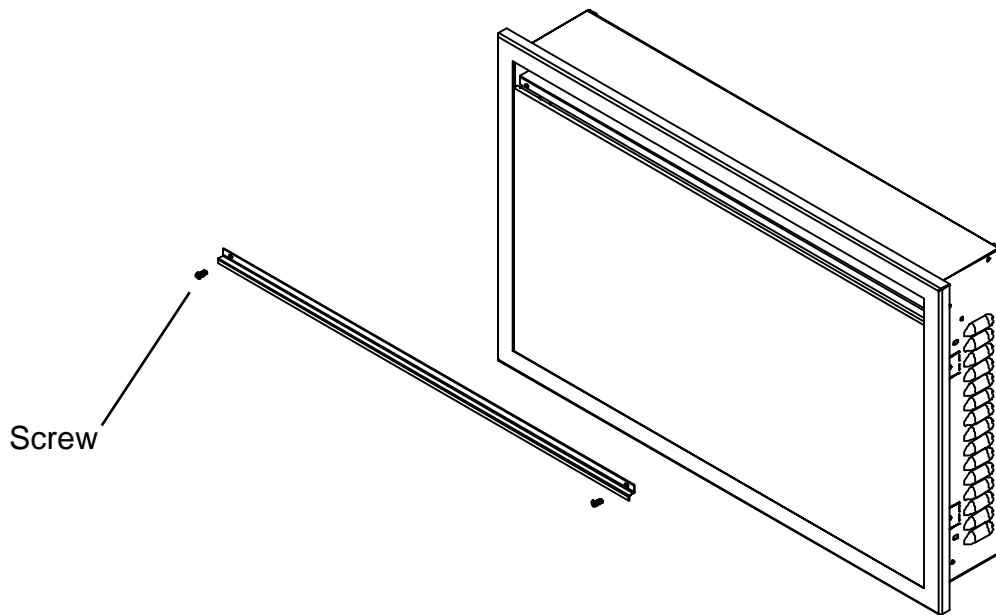

3. Take off the front glass when the covering bar's removed.

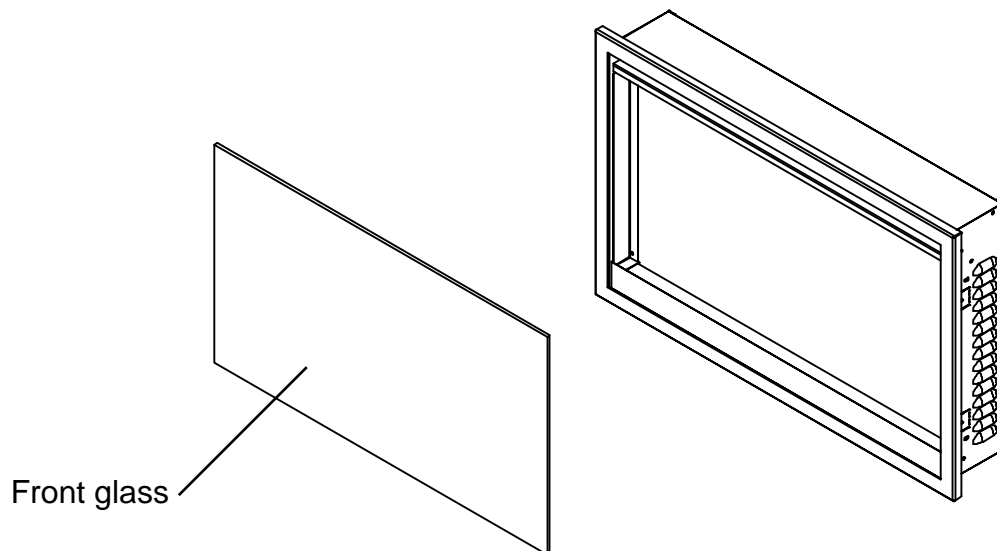

4. Unscrew 2 screws on each side to take off the inner side bar.

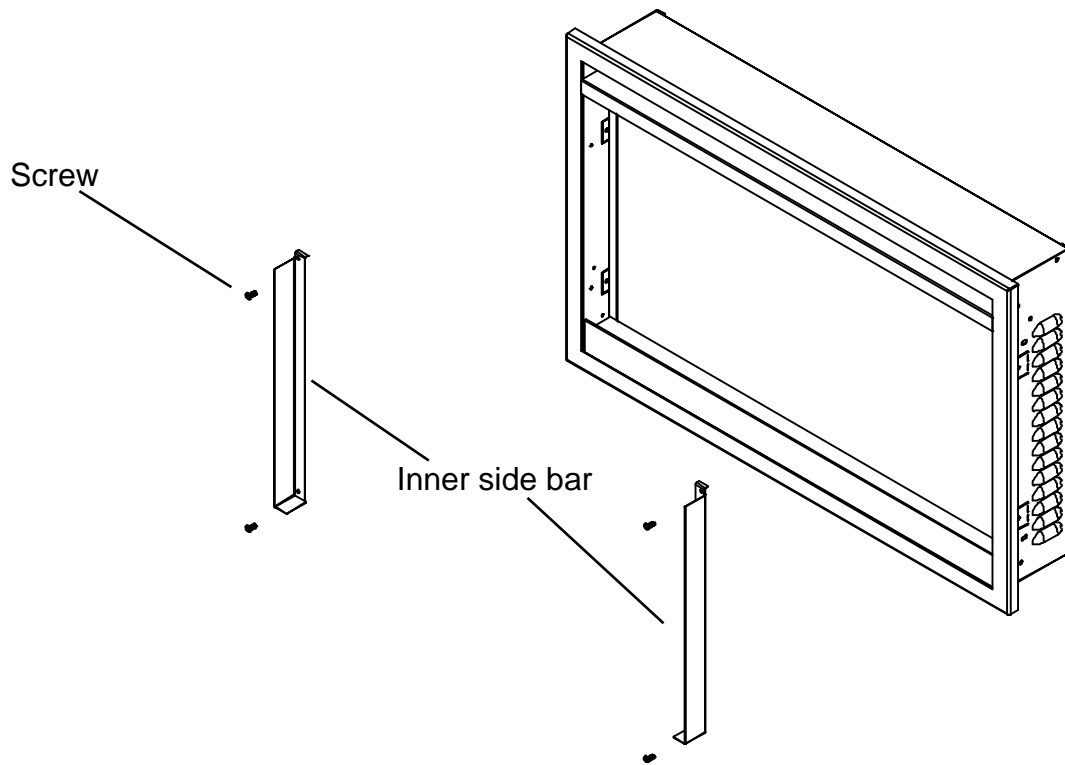

5. Screw back the inner side steel bar with long screws put in the manual bag.
(NOTE: You should leave gap for air circulation when install the fireplace into a wall.
An air entrance slot is suggested. Or the fireplace will undergo overheat and get damaged)

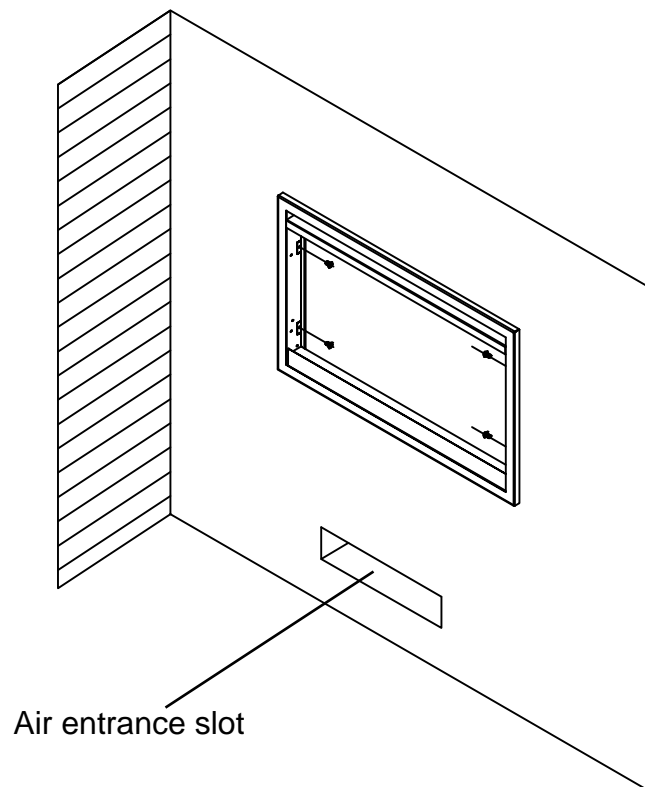

6. Screw back the front glass panel after you finish the media decoration and put back the steel bar you take off from STEP 1.

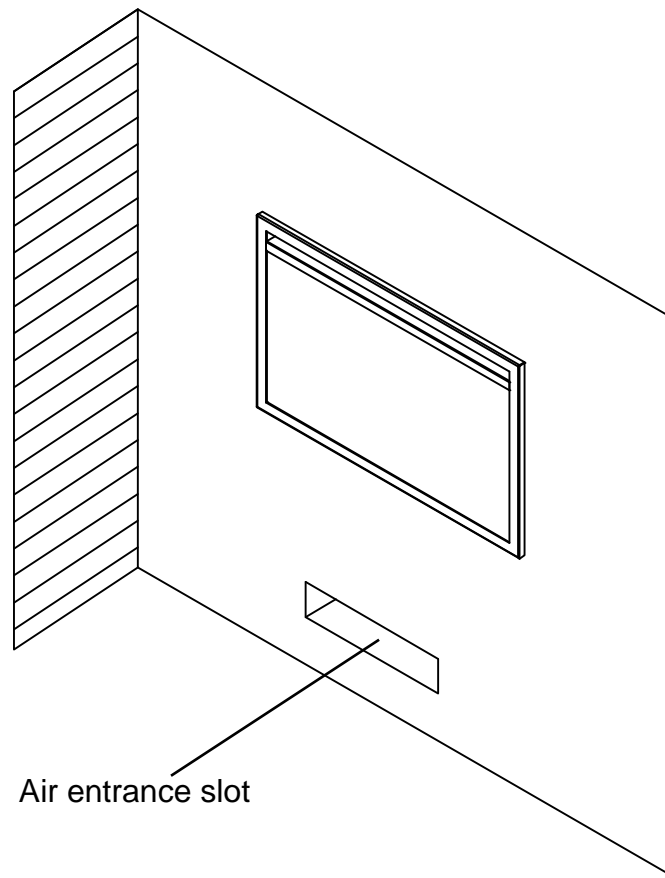

HARD- WIRE INSTALLATION

Turn off the appliance completely and let cool before servicing. Only a qualified service person should service and repair this electric appliance.

If it is necessary to hard-wire this appliance, a qualified electrician must remove the cord connection, and wire the appliance directly to the house hold wiring.

This appliance must be electrically connected and grounded in accordance with local codes, if hard-wired. In the absence of local codes, use the current CSA C22.1 CANADIAN ELECTRICAL CODE in Canada or the current ANSI/NFPA 70 NATIONAL ELECTRICAL CODE in the United States.

1. Remove the cover plate from the left side of the appliance by removing the two screws, as shown below. Unscrew and remove power cord.



2. Cut off the copper head of the wiring and leave 1 cm (0.4 inch) uncovered wiring.

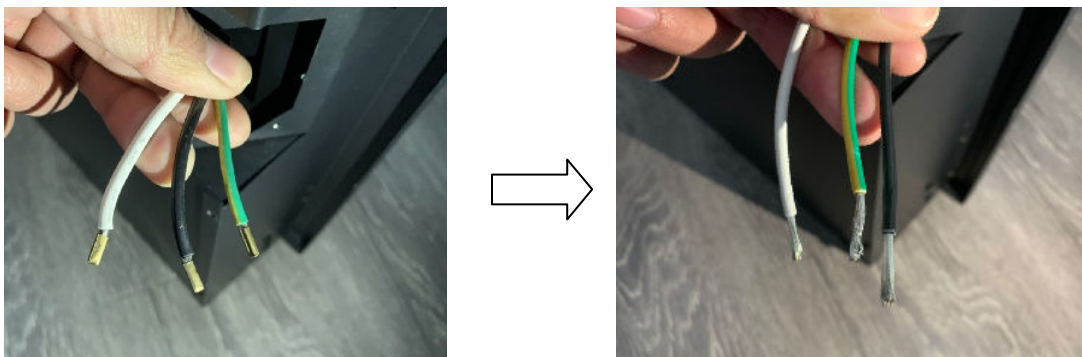

3. Connect the uncovered wiring with 14 A WG wiring (not provided with the appliance) by a wiring connecting cap which you can find in the manual bag. Please make sure the live wire goes into the “L”, the neutral wire into “N” and the ground wire into “G”.

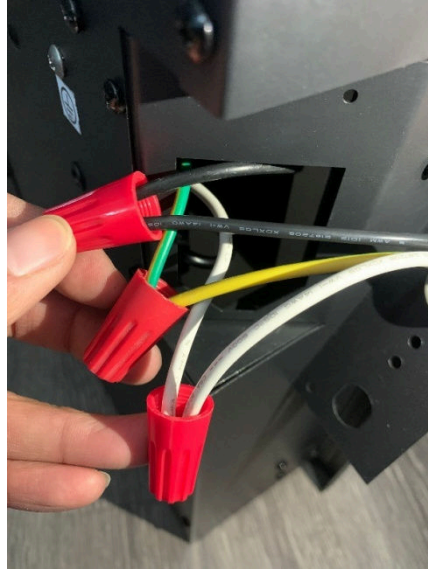

4. Return the cover plate to the left side, adding a wiring protector which you can find in the manual bag, and screw the two screws back in to fasten the plate.



MEDIA OPTIONS

The only media that comes with this appliance is 'Clear glass'. Consumers may purchase optional decorative media if they choose. See dealer for more details.

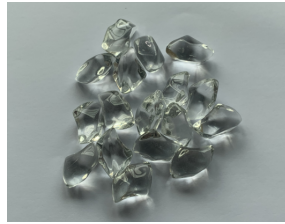

Clear glass

DECORATIVE MEDIA INSTALLATION

Take off the steel bar at the outlet of the heater which is fixed with magnetic stones. Unscrew the screws to take off the front glass fixing steel bar.

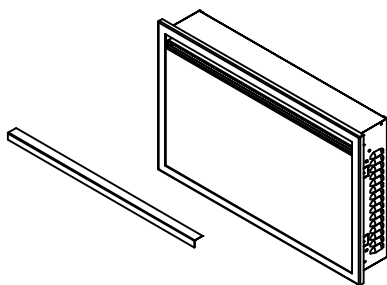

STEP 1

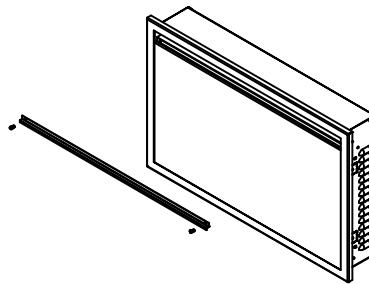

STEP 2

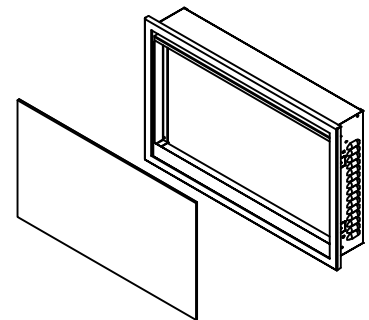

STEP 3

INSTALLING THE DECORATIVE MEDIA

Pour the fire glass media into the tray. Feel free to use any combination of the fire glass media that you find most appealing. Put back the trim and front glass after you finish installing the fire glass.









OPERATION

The fireplace can be operated either by the touch panel located on the left front top side of the fireplace, or by supplied remote control.

Plug the fireplace into a 15 Amp wall socket.

MANUAL OPERATION













1. Press  to turn on and off the fireplace.
2. Press  to adjust the flame's brightness. There are 7 brightness levels (L5 – L4 - L3 – L2 – L1 – L0 – L6). The indicator light turns off automatically leaving it not operated within 10 seconds.
3. Press  to adjust the ember bed brightness. There are 12 brightness levels (D4 – D5 – D6 – D7 – D8 – D9 – DA – DB – D0 – D1 – D2 – D3).
4. Press  to set the turn-off time, 30min-1h-2h-3h-4h-5h-6h-7h-8h-t0. The indicator light turns off automatically leaving it not operated within 10 seconds. The timing turns off when  is pressed.
5. Press  to turn on and off the heater in its AUTO mode. The setting temperature switch through 59°F - 61°F - 63°F - 64°F - 66°F - 68°F - 70°F - 72°F - 73°F - 75°F - 77°F - 79°F - 81°F - 83°F - °F in Fahrenheit or 15°C -16°C -17°C - 18°C - 19°C - 20°C - 21°C - 22°C - 23°C - 24°C - 25°C - 26°C - 27°C - 28°C - °C in Celsius. The temperature setting mode will be closed automatically if leaving not operated for 5 seconds.
6. When the heater is on, press the  for 5 seconds to switch between Celsius and Fahrenheit.

REMOTE CONTROL OPERATION

For remote to function make sure the fireplace is plugged in and the remote has batteries.

Important: When operating the remote make sure you point the remote to the center of the fireplace. Each time you press the button, the buzzer inside the unit will beep once. It takes some time for the receiver to respond to the transmitter. Do not PRESS the buttons more than once within two seconds for correct operation.

Set the current time of the remote control

Press the  to activate the remote control and press to set  the time and date. When one of the “Sun” “Mon” “Tue” “Wed” “Thu” “Fri” “Sat” is flashing, press  or  to set the day of the week, press  to confirm day of the week and then enter hour setting. Press  or  to set the hour, press  to confirm the hour and then enter minute setting. Press  or  to set the minute and press  to confirm the minute and finish time setting.

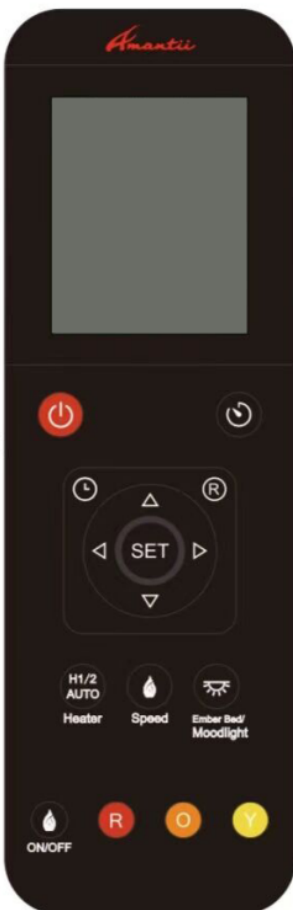





Press this Power button to turn on and off the fireplace.



Press this Timer button to set the time to turn off the fireplace. The available settings range from 30 minutes to 8 hours. As shown in the following: 0:30 - 1:00 - 1:30 - 2:00 - 2:30 - 3:00 - 3:30 - 4:00 - 4:30 - 5:00 - 5:30 - 6:00 - 6:30 - 7:00 - 7:30 - 8:00. Once you have set the timer, the  icon will be displayed on the LCD screen of the remote control. Press this button again to cancel the timer setting and the icon disappears.





Press the HEATER button once, one setting of heater works, 750W, indicating “H 1” on display; Press again, two settings of heater work, 1500W, indicating “H 2” on display; Press for the

third time to turn on the AUTO mode, press  or  to set the temperature and  or  to switch temperature unit between Celsius and Fahrenheit.





Press this button to adjust the speed of the flame. There are 3 options: High-Medium- Low.













Press this button to turn on and off the ember bed light. When in ON position, the display screen of the remote control shows AD 1, when the number “1” flashes, you can set the color of the ember bed by  or . There are 10 different ember bed light colors (AD1-10). When in AD 11 status, the color of the ember bed light cycles through 10 colors. Press “SET” to confirm the setting.







Press the Flame button to turn on and off the Flame. When in ON position, the LCD screen of the remote control shows 6 6 6. Press  or  or  to change the brightness of each color flame.







7 Day Timer Function

Press  once, 7 days from Monday to Sunday will display on the LCD screen of the remote control, press  within 5 seconds to enter 7 day timer function. When “Sun” flashes, press  or  to select the day that you want to set, press  to confirm your setting. Then “ON” will be display on the LCD screen of the remote control, at the same time, digital of time hour flashes, press  or  to set the time to turn the fireplace on. After setting the startup time, “OFF” will be displayed on the LCD screen and press  or  to set the shutdown time. When the shutdown time’s set, “AUTO” will be displayed on the LCD screen of the remote control and the digital of temperature flashes. At this time, you can set the temperature by  or . Now, you have finished setting of this function.

When the 7 day timer's set, the icon  will be displayed on the LCD screen of the remote control. Press  again to cancel the 7 day timer and the icon  will disappears.

NOTE: If the 7 day timing  and the general timing  are set at the same time, the system will respond to an earlier shutdown time.

 Press Refer button to check the settings of 7 day timer. Press  or  to see the settings of the day of the week and  or  the settings of the startup and shutdown time.

WIFI OPERATION

INSTALL TuyaSmart life

There are 2 ways to install TuyaSmart;

1. Search for “TuyaSmart life” in the APP store on your phone, download and install.
2. Scan the QR code below with your mobile phone.



WIFI SETTING AND FIREPLACE OPERATION

1. Create an account and log in.
2. When you log in, touch “+” (FIG.1) to enter in FIG.2. Touch “others” on the left corner first and then choose “Connector (Wi-fi)” to enter in FIG.3 to set your Wi-fi account and password.

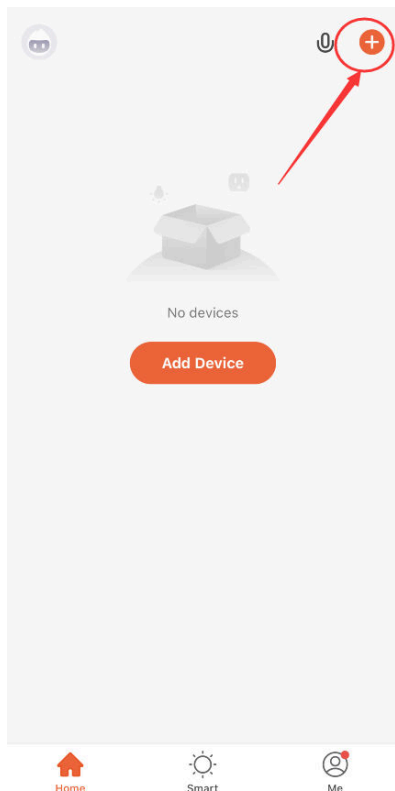

FIG.1



FIG. 2

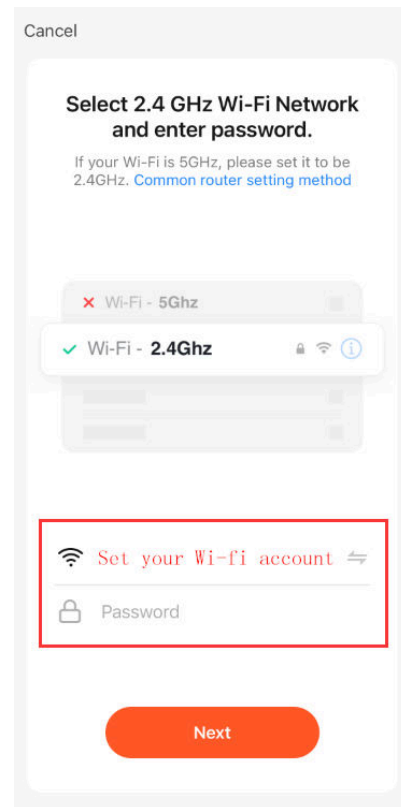

FIG.3

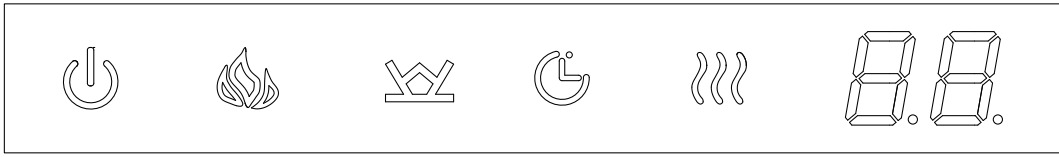



FIG.4

3. Press  (flame button) on the touch panel of the fireplace for more than 5 seconds when the fireplace is in standby mode. There will be 2 beeps come out from the fireplace and the  (flame button) will flash as well indicating that Wi-fi is in EZ mode. Then please confirm to go next. (FIG.5)
4. The APP will scan (FIG.6) and add the fireplace to APP (FIG.7) automatically. Please make sure the Wi-fi account and password you set are correct and Wi-fi signal is good.
5. Touch “Done” to finish Wi-fi setting.(FIG.7)

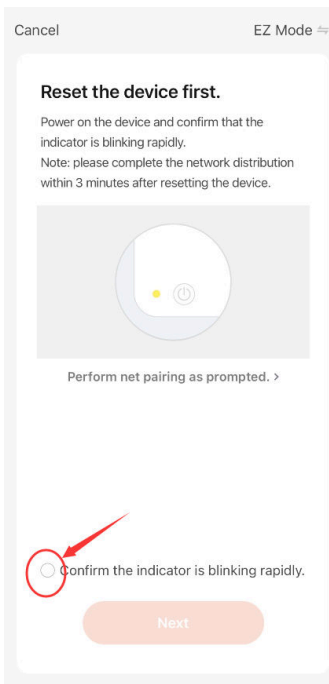

FIG.5

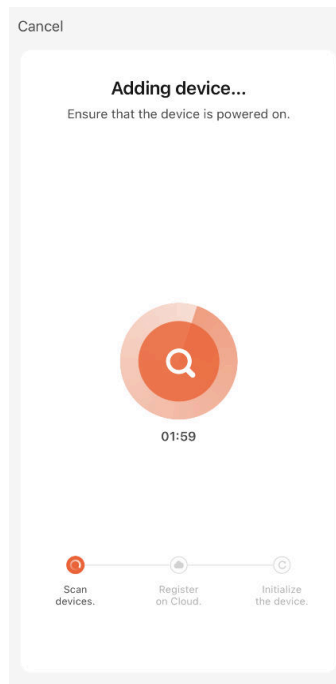

FIG.6

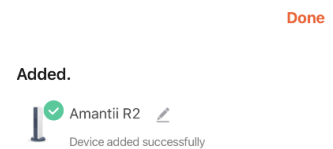

FIG.7

6. Now you are in the interface like FIG.7. You can operate the fireplace via Wi-fi.

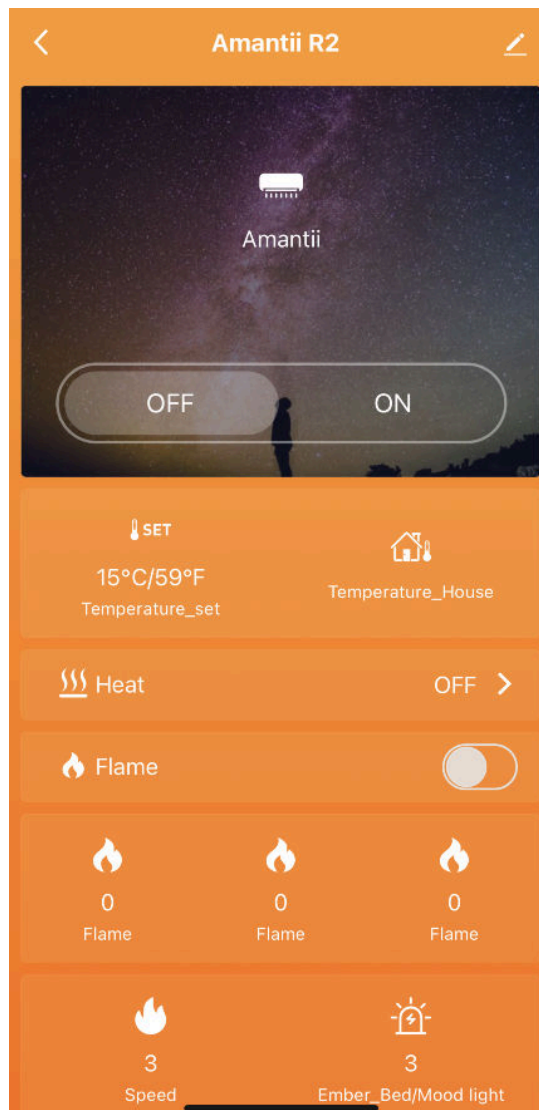
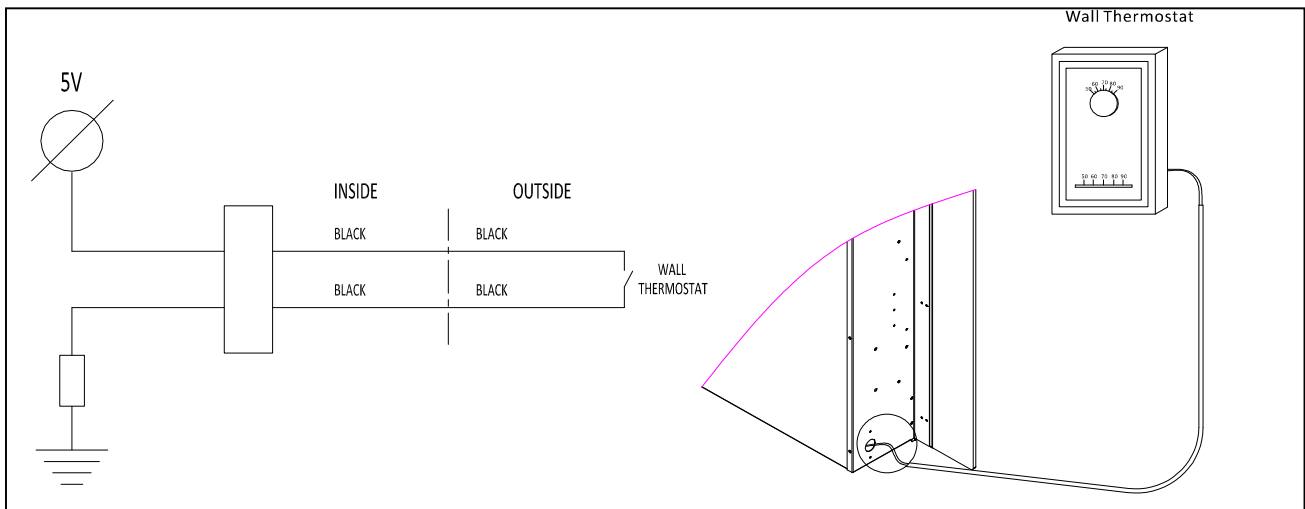

FIG.7

INSTALLING WALL THERMOSTAT

WALL THERMOSTAT WIRING DIAGRAMS



NOTE: The wall thermostat will be functioning when the heater is on the **TEMP.** setting.

Wire the wall thermostat prior to installing the fireplace.

WALL THERMOSTAT WIRING (24 AWG)

Install Wall Thermostat per instructions provided with kit and per the following information:

1. Turn off circuit breaker.
2. Remove cover plate located at the bottom on the left side of the appliance.
3. Pull the wire out and cut the inside thermostat. Connect the wires to the wall thermostat as shown below. Follow the instructions provided with wall switch kit.



REPLACEMENT PARTS

NO	PART NUMBER			DESCRIPTION	QTY
	TRD-26 XTRASLIM	TRD-30 XTRASLIM	TRD-33 XTRASLIM		
1	3241502	3242502	3243502	TRIM	1
4	107012411	107012421	107012431	FRONT GLASS	1
5	107022411	107022421	107022431	BACK GLASS	1
6	601144			FLAME LED STRIP	2/2/2
7	10101501			FLAME MOTOR	1
9	10114001B			TEMPERATURE SENSOR	1
10	3001506B			SIGNAL RECEIVER	1
11	10124129			CIRCUIT BOARD	1
12	601300E			TOUCH PANEL	1
13	602130C			BLOWER AND HEATER ASSEMBLY	1
14	3241505	3242505	3243505	FLICKER ASSEMBLY	1
15	107022412	107022422	107022432	TRAY GLASS	1
16	10125046	10125021	10125047	TRAY LIGHT	1
17	212051			WIFI CARD	1
18	10105501			REMOTE CONTROL	1

NOTE: 15,16,17,18 are not shown at the exploded view.

EXPLODED VIEW

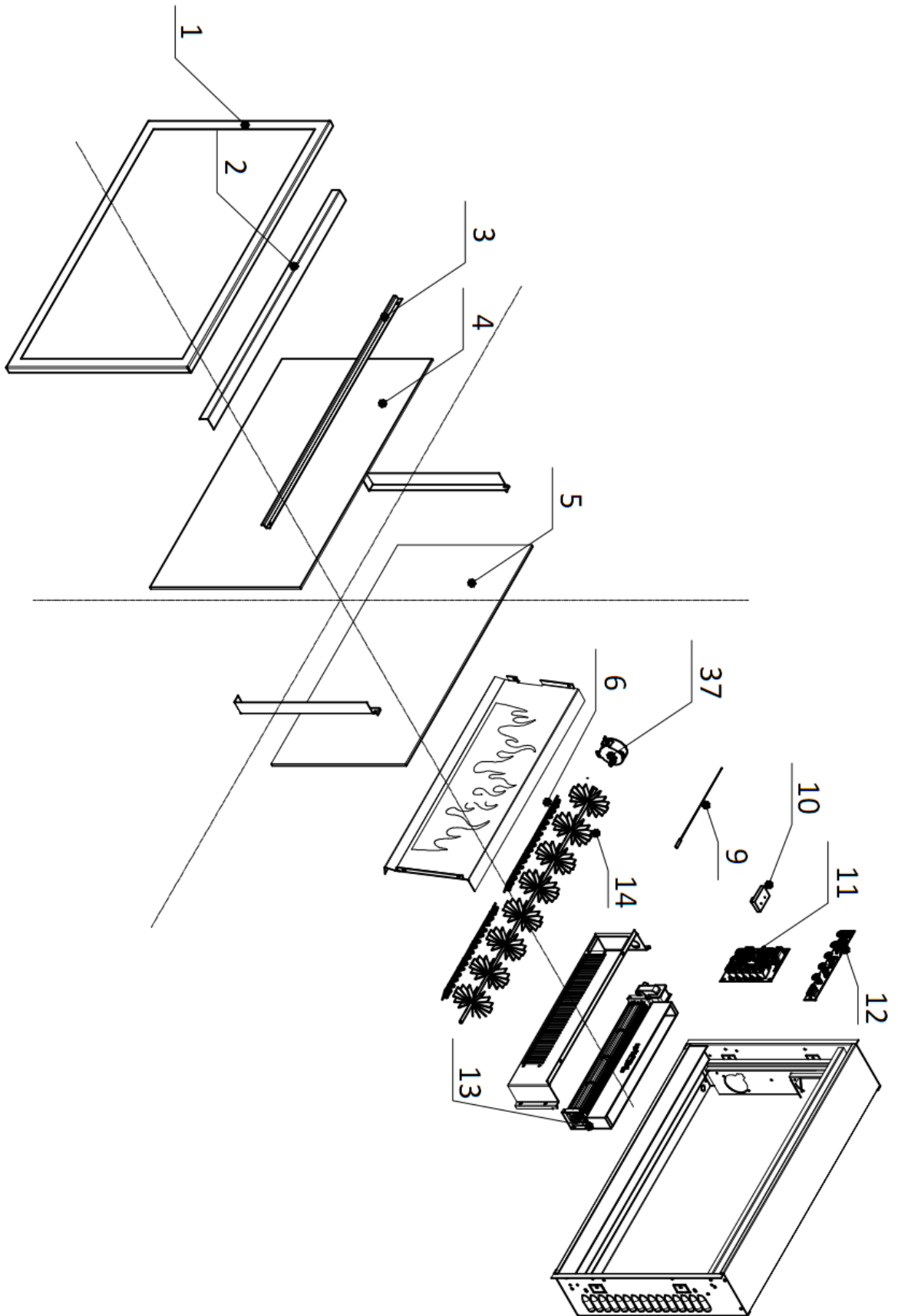

TROUBLE SHOOTING

PROBLEM	POSSIBLE CAUSE	SOLUTION
Dim or no flame	Flame LED's are burnt out	Inspect the LED's and replace them if necessary
	Back black cloth is falling off and roll the flicker	Change a new flicker and back black cloth
Ember bed is not glowing or dimming	Ember LED's are burnt out	Inspect the ember bed LED's and replace them if necessary
Appliance turns off and will not turn on	Appliance has overheated and safety device has caused the thermal switch to disconnect	Turn off the main switch, allow appliance to cool for 10 minutes, then turn it on
	House circuit breaker has tripped	Reset house circuit breaker
	Appliance's fuse has blown	Replace the fuse
Appliance will not come on when switch is flipped to ON	Appliance is not plugged into an electrical outlet	Check plug and plug in
	Appliance has overheated and safety device has caused the thermal switch to disconnect	Turn off the main switch, allow appliance to cool for 10 minutes, then turn on
	Circuit board is burnt out	Inspect the circuit board and replace if necessary
No warm air coming out of appliance	Heater is burnt out	Inspect the burner and heater assembly and replace if necessary
Flame sputters	Flame motor is defective	Call a qualified service technician and replace flame motor
Remote Control does not work	Low batteries Unit switch in "O" position	Replace AAA batteries in remote control Turn the switch in "I" position
Flame is fixed	Wiring may be loose or the flame motor may be defective	

SERVICE HISTORY

This heater must be serviced annually depending on usage.

Date	Dealer Name	Service Technician Name	Service Performed	Special Concerns

NOTES:

WARRANTY FOR PRODUCTS MANUFACTURED AFTER 1st, 2016

Amantii Imports Corp. ("Amantii") warrants that your newly purchased Amantii electric fireplace is free from manufacturing and material defects for a period of two (2) years from the date of the first purchase, subject to the conditions and limitations contained below.

Warranty Application & Exclusions

This limited warranty applies to your newly purchased Amantii electric fireplace; the limited warranty's application is limited to purchases made in any province of Canada or in any of the 52 States of the United States of America, including the District of Columbia. Only the original purchaser of the product is eligible for coverage under this limited warranty; the warranty is not transferable.

Products excluded from this limited warranty

Light bulbs are not covered by this limited warranty and are the sole responsibility of the owner/purchaser. Amantii does not cover service or labor charges.

Warranty Coverage and Team

Products covered by this limited warranty have been tested and inspected prior to shipment and subject to the terms & conditions of this warranty, Amantii warrants such products to be free from defects in material and workmanship for a period of two(2) year from the date of the first purchase.

The limited two (2) year warranty period for this product also applies to any implied warranties that may exist under applicable law. Some jurisdictions do not allow limitations on how long an implied warranty lasts, so the above limitation may not apply to the purchaser.

All other warranties - expressed or implied - with respect to the product, its components and accessories or any obligation/liabilities on the part of Amantii are hereby expressly excluded.

Limitations to Coverage under Limited Warranty

This limited warranty does not apply to products that have been repaired or otherwise altered, except by Amantii or its authorized service representatives. This limited warranty does not apply to defects resulting from misuse, abuse, accident, neglect, incorrect installation, improper maintenance or handling, or operation with an incorrect power source. Products made by other manufacturers, sold with the product or thereafter, are not covered by this limited warranty. The use of unauthorized components will render this warranty null and void.

Panorama Outdoor Units

All Panorama units that are installed or in moisture intense conditions must use the stainless steel cover. Proof of purchase of the cover is required for any warranty claims

Defects

Defects must be brought to the attention of the selling dealer. Please have your proof of purchase, catalogue/model and serial numbers available when contacting dealer; any and all service under the limited warranty requires a proof of purchase of the product. Should a product or part covered by this limited warranty be proven to be defective, in material or workmanship, and during the two (2) year limited warranty period, Amantii will replace such defective product or part without charge. If Amantii is unable to replace such product, or if replacement is not commercially practicable or cannot be timely done, in its sole discretion Amantii may, in

lieu of replacement, choose to refund the purchase price for such product or part. Amantii does not cover labor or service charges to replace said parts.

Limitations

In no event will Amantii, including without limitation any of its directors, officers, shareholders, employees, consultants, agents, heirs, executors, administrators and assigns, be liable to the purchaser or any third party, whether in contract, in tort, or on any other basis for any indirect, special, punitive, exemplary, consequential, or incidental loss, cost or damage arising out of or in connection with the sale, maintenance, use or inability to use the product, even if Amantii, including without limitation any of its directors, officers, shareholders, employees, consultants, agents, heirs, executors, administrators and assigns, have been advised of the possibility of such losses, costs or damages, or if such losses, costs or damages are foreseeable. In no event will Amantii, including without limitation any of its directors, officers, shareholders, employees, consultants, agents, heirs, executors, administrators and assigns, be liable for any direct losses, costs or damages that exceed the purchase price of the product.

Some jurisdictions do not allow the exclusion or limitation of incidental or consequential damages, so the above limitation or exclusion may not apply to the purchaser.

Application of Provincial and State law

This limited warranty gives you specific legal rights, and you may also have other rights which vary from jurisdiction to jurisdiction. The provisions of the United Nations Convention on Contracts for the Sale of Goods shall not apply to this limited warranty or the sale of products covered by this limited warranty.

General

Amantii reserves the right to make changes at any time without notice, in design, material, specifications, prices and the right to discontinue styles and products.