



TIMELESS NORWEGIAN CRAFT

...built in Maine

“Jøtul – a life-long source of warmth and comfort.”

Dealer info:

WOOD
PRODUCTS

CONTENTS

JØTUL F 602 CB	page 9
JØTUL F 100 NORDIC QT CF	page 10
JØTUL F 3 CB	page 11
JØTUL F 400 CASTINE	page 12
JØTUL F 400 CASTINE CF	page 13
JØTUL F 118 CB BLACK BEAR	page 14
JØTUL F 500 OSLO	page 15
JØTUL F 500 OSLO CF	page 16
JØTUL F 600 FIRELIGHT CB	page 17
JØTUL F 370	page 18
JØTUL F 45 GREENVILLE	page 22
JØTUL F 50 TL RANGELEY	page 23
JØTUL F 55 CARRABASSETT	page 25
JØTUL C 350 WINTERPORT	page 28
JØTUL C 450 KENNEBEC	page 29
JØTUL C 450 KENNEBEC CF	page 30
JØTUL C 550 ROCKLAND CB	page 31
JØTUL C 550 ROCKLAND CB CF	page 32
HEATING CAPACITY BY ZONE	page 33
TECHNICAL SPECIFICATIONS	page 34

Jøtul has a policy of constant improvement and upgrading. Products therefore may differ in specification, design, material or dimensions at any time without prior notice. Some settings of the photographs are for aesthetic purpose only and may not comply with installation requirements.

A 160 YEAR LONG NORWEGIAN ADVENTURE

With its 160 year history, Jotul is the longest running producer of wood stoves in the world. The adventure began in Loelva in 1853, when Oluf Onsum, the son of a farmer, founded Kvaerner Jernstoberi. Kvaerner began developing cast iron products, and by 1900 the company had one of the largest wood stove foundries in Norway.



During the early 1900s, Kvaerner was the most advanced mechanical workshop in Norway, and gradually they expanded their focus to new products. In 1916, they sold the wood stove production facility to 26-year-old Herman Anker, who renamed the foundry Kvaerner Ovnsstoperi. His goal was to advance the quality and design of the products while continuing the legacy of Norwegian cast iron traditions. Anker was a savvy businessman who recognized the value of marketing and an advanced sales team long before this was common practice. With that, the foundation of the Jotul brand was made.

During the 1920s, the international economy experienced a serious



decline, and Jotul faced bankruptcy. They were saved by Johannes Gahr, who shared many of his predecessor's qualities, and steered Jotul out of the crisis and into a new era of growth. Once again, Jotul was the largest producer of wood stoves in Norway.

As new sources of energy such as oil, kerosene, and electricity developed, demand for wood stoves decreased.

However, Jotul continued to grow in the period following World War II, and by the 1960s, they were by far the largest of the few players left in the market. Jotul adapted to the changing market, and by the 1970s, fireplaces burning liquid fuel had become the company's largest source of income. Following the oil crisis of the 1970s, the demand for woodstoves exploded, and wood stoves once again became the most important part of Jotul's product range.

In 1977, the Gahr family sold Jotul to the major international corporation Norcem. As exporting became a major focus, the company acquired foundries and import companies in the US and Europe. In recent years, Jotul has once again built an international network and become a global brand with subsidiaries and distribution facilities around the world.

Through the highs and lows of the last 160 years, Jotul has proven itself to be a survivor, and we continue to grow and develop as a company. The success can be attributed to courage, desire, and the ability to adapt to new needs and markets. Jotul is still going strong, as a stove foundry and a global



market leader, and we invite you to join us as the adventure continues

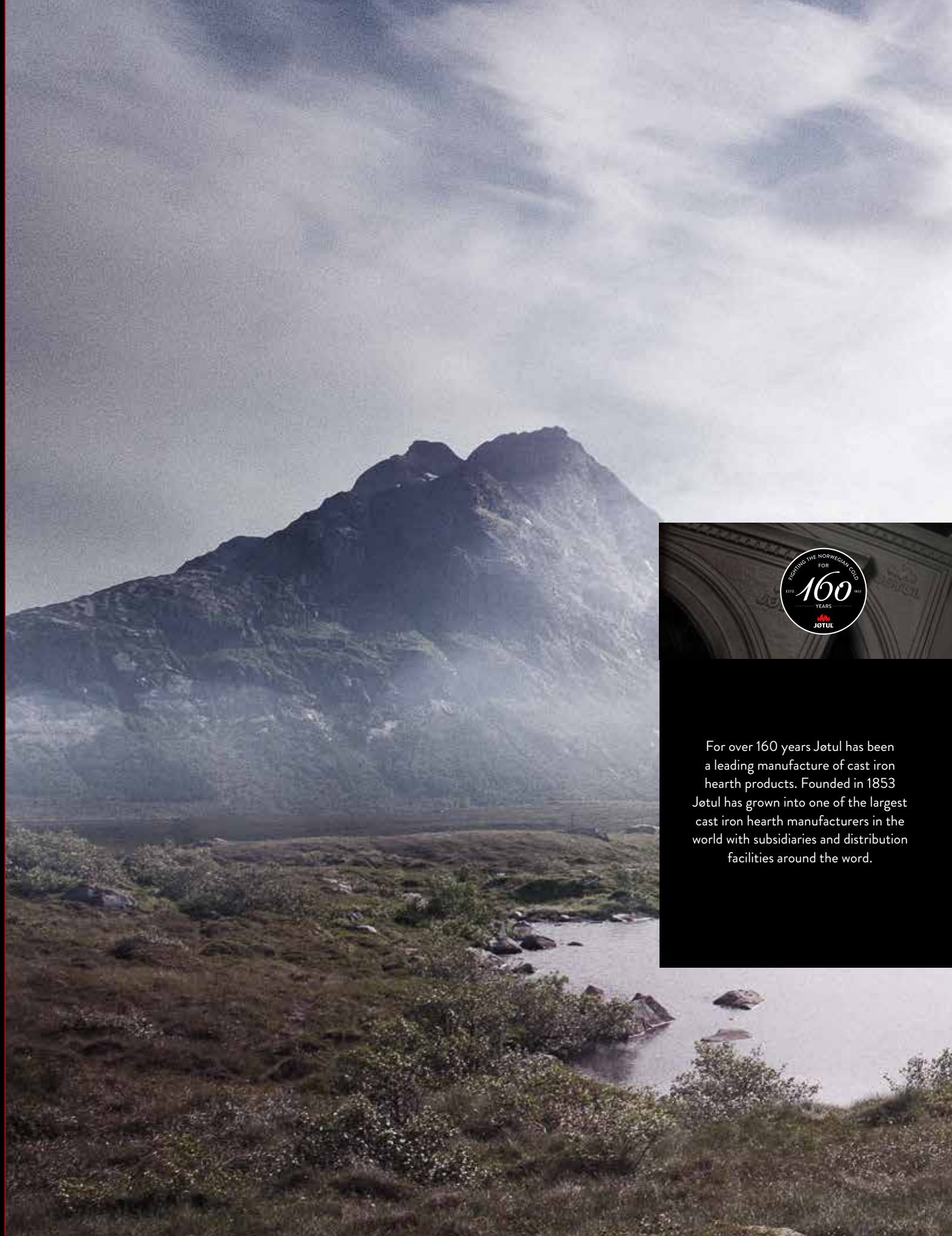

For over 160 years Jotul has been a leading manufacture of cast iron hearth products. Founded in 1853 Jotul has grown into one of the largest cast iron hearth manufacturers in the world with subsidiaries and distribution facilities around the word.

🇳🇴 TIMELESS NORWEGIAN CRAFT

...built in Maine

Jøtul's cast iron stoves and fireplaces have been crafted in Norway since 1853. For more than 160 years Jøtul has worked and mastered the art of fighting the cold.

In 2015 Jøtul expanded its operation in Maine to include production for the North American market. This is the background for our current position as market leader and the preferred choice for customers who want the best all over the world.



CAST IRON – PREFERRED BY GENERATIONS

The choice to produce our products from cast iron is exclusively based on the material's extreme high quality and durability. When used properly wood stoves from Jøtul do not deform, the doors stay in place, and hinges and closing mechanisms remain reliable even after long-term use. In addition, spare parts extend the longevity of a Jøtul product further.

PURE HEAT FROM NORWAY

Norway is known around the world for their focus towards sustainability and the environment and we have the strictest demands regarding emissions in the world. This is why Jøtul strives to maximize fuel utilization and optimize the heating effect from all their products. This is good news for your wallet and the environment.



AWARD-WINNING TIMELESS DESIGN

Jøtul products represent functional, modern design. They are innovative, yet stand the test of time beyond short-term trends. At Jøtul, we are convinced that form should follow function, and that good design is more than meets the eye. Several of our products have been recognized with design awards.





JØTUL F 370

ENJOY THE HEAT FROM A MODERN DESIGN STOVE

The Jøtul F 370 is characterized by a timeless, award-winning design, and it is one of the world's best-selling wood stoves. The combustion chamber is surrounded by glass windows, creating an optimal three-sided fire view. This wood stove is the first and only in the world to have won the prestigious international Red Dot Design Award: Best of the Best.

JØTUL F 500 OSLO

HOT. VERY HOT.

The Jøtul F 500 Oslo is large enough to heat your entire house during those long cold winter days and nights. With its signature Gothic arch design and large fire viewing area, the Jøtul F 500 Oslo is the best selling large non-catalytic cast iron wood stove sold in North America.





...built in Maine



Quality Cast Iron

Throughout the years this line of freestanding woodstoves and inserts has earned a reputation for being some of the best on the market for heating properties, quality, and durability.

JØTUL F 602

Eva Horton, the pioneering importer of Jøtul stoves in North America, shared the warmth of this stove with her neighbors in Maine in the early 1970s. Her early efforts led to Jøtul earning the dominant position in the cast iron hearth industry that it still enjoys today. The Jøtul F 602 CB "Little Giant" is the very definition of classic and comprises half of our Heritage line of wood stoves.

HEATING CAPACITY: Up to 800 sqft
MAXIMUM HEAT OUTPUT: Up to 28,000 BTU/hr
EFFICIENCY: LHV 70.6% - HHV 76.27%
BURN TIME: Up to 5 hrs
EMISSIONS: 3.4 grams/hr
LOG SIZE: Up to 16"
FIREBOX SIZE: .82 ft³
WEIGHT APPROX. 160 LBS
DIMENSIONS (HXWXD):
25 1/4" x 12 5/8" x 21 1/4"
MINIMUM HEARTH DIMENSIONS (W X D)
28 1/2" x 45 1/2"

ACCESSORIES: Screen, rear heat shield, fresh air kit, stove top thermometer, and stove gloves



BP





JØTUL F 100 NORDIC QT CF

Showcasing a detailed cast iron pattern based on a traditional Norwegian sweater and offering an unobstructed view of the fire, the Jøtul F 100 Nordic QT CF (clean face) is the perfect space heater for cottages, camps, and smaller living areas. This powerful stove continues our tradition of design and innovation with the Jøtul Simplex™ clean burn technology, which optimizes fire viewing area, fuel loading convenience, and combustion efficiency.

HEATING CAPACITY: Up to 800 sqft
 MAXIMUM HEAT OUTPUT: Up to 35,000 BTU/hr
 EFFICIENCY: LHV 78.75% - HHV 72.85%
 BURN TIME: Up to 6 hrs
 EMISSIONS: 3.0 grams/hr
 LOG SIZE: Up to 16"
 FIREBOX SIZE: .85 ft³
 WEIGHT APPROX: 215 lbs
 DIMENSIONS (HXWXD):
 22 1/2" x 20 3/4" x 17 1/2"
 MINIMUM HEARTH DIMENSIONS (W X D)
 37" x 38"

ACCESSORIES: Flue collar heatshield, long leg kit, leg leveler kit, fresh air kit, stove top thermometer, and stove gloves



BP



JØTUL F 3 CB

The Jøtul F 3 CB is the world's best value for your heating dollar and remains the best selling small cast iron wood stove in North America. Selling up to 20,000 stoves worldwide each year, the Jøtul F 3 CB has an impeccable track record for durability - as do all of our stoves.

HEATING CAPACITY: Up to 1,200 sqft
 MAXIMUM HEAT OUTPUT: Up to 42,000 BTU/hr
 EFFICIENCY: LHV 78.71% - HHV 72.79%
 BURN TIME: Up to 7 hrs
 EMISSIONS: 3.78 grams/hr
 LOG SIZE: Up to 18"
 FIREBOX SIZE: 1.17 ft³
 WEIGHT APPROX: 265 lbs
 DIMENSIONS (HXWXD):
 28" x 22 7/8" x 19"
 MINIMUM HEARTH DIMENSIONS (W X D)
 39" x 39"

ACCESSORIES: Screen, short leg kit, leg leveler kit, fresh air kit, stove top thermometer, and stove gloves

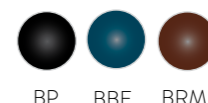

BP BBE BRM



JØTUL F 400 CASTINE

Handsomely detailed in cast iron, the F 400 Castine's nautical styling recalls the coves and shores locked amid the rocks and pines of Maine. Featuring meticulous craftsmanship and practical design, the Jøtul F 400 Castine will provide a warm, wonderful centerpiece for your hearth and home.

HEATING CAPACITY: Up to 1,500 sqft
 MAXIMUM HEAT OUTPUT: Up to 55,000 BTU/hr
 EFFICIENCY: LHV 73.78% - HHV 68.29%
 BURN TIME: Up to 8 hrs
 EMISSIONS: 3.77 grams/hr
 LOG SIZE: Up to 20"
 FIREBOX SIZE: 1.77 ft³
 WEIGHT APPROX: 375 lbs
 DIMENSIONS (HXWXD):
 28 1/2" x 25 3/4" x 23 1/4"
 MINIMUM HEARTH DIMENSIONS (W X D)
 42" x 44"



ACCESSORIES: Screen, short leg kit, rear heatshield, leg leveler kit, outside air kit, stove top thermometer, and stove gloves

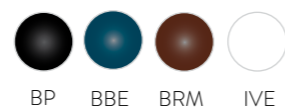

JØTUL F 400 CASTINE CF

Jøtul's medium-sized single door, non-catalytic woodstove just got better, with an unobstructed fire-view and air wash performance. Featuring meticulous craftsmanship and practical design, the Jøtul F 400 Castine CF (clean face) will provide a warm, wonderful centerpiece for your hearth and home.

HEATING CAPACITY: Up to 1,500 sqft
 MAXIMUM HEAT OUTPUT: Up to 55,000 BTU/hr
 EFFICIENCY: LHV 73.78% - HHV 68.29%
 BURN TIME: Up to 8 hrs
 EMISSIONS: 3.77 grams/hr
 LOG SIZE: Up to 20"
 FIREBOX SIZE: 1.77 ft³
 WEIGHT APPROX: 375 lbs
 DIMENSIONS (HXWXD):
 28 1/2" x 25 3/4" x 23 1/4"
 MINIMUM HEARTH DIMENSIONS (W X D)
 42" x 44"



ACCESSORIES: Screen, short leg kit, rear heatshield, leg leveler kit, outside air kit, stove top thermometer, and stove gloves

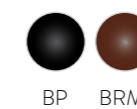



JØTUL F 118 CB BLACK BEAR

The Jøtul F 118 CB Black Bear is a timeless classic which has been updated with clean-burn technology and new details. The front of the wood stove is decorated with an ancient Norwegian prayer that was believed to keep the fire lit and the dark forces away from the house.

HEATING CAPACITY: Up to 1,500 sqft
 MAXIMUM HEAT OUTPUT: Up to 55,000 BTU/hr
 EFFICIENCY: LHV 78.86% - HHV 72.94%
 BURN TIME: Up to 8 hrs
 EMISSIONS: 3.43 grams/hr
 LOG SIZE: Up to 24"
 FIREBOX SIZE: 1.47 ft³
 WEIGHT APPROX: 340 lbs
 DIMENSIONS (HXWXD):
 30 1/2" x 14" x 31 1/2"
 MINIMUM HEARTH DIMENSIONS (W X D)
 30 1/2" x 53"

ACCESSORIES: Screen, side and rear heatshield, leg leveler kit, fresh air kit, stove top thermometer, and stove gloves



BP



JØTUL F 500 OSLO

Choosing a large woodstove? This is one of our most popular models and a true performer. The Jøtul F 500 Oslo wood stove features both front and left side-loading convenience, plus its legendary non-catalytic clean burn combustion efficiency.

HEATING CAPACITY: Up to 2,000 sqft
 MAXIMUM HEAT OUTPUT: Up to 70,000 BTU/hr
 EFFICIENCY: LHV 79.88% - HHV 73.94%
 BURN TIME: Up to 9 hrs
 EMISSIONS: 3.2 grams/hr
 LOG SIZE: Up to 24"
 FIREBOX SIZE: 2.54 ft³
 WEIGHT APPROX: 445 lbs
 DIMENSIONS (HXWXD):
 28 1/2" x 28 1/4" x 27 1/4"
 MINIMUM HEARTH DIMENSIONS (W X D)
 54 1/2" x 50 1/2"

ACCESSORIES: Cookplate, blower fan kit, screen, rear heatshield, leg leveler kit, outside air kit, stove top thermometer, short leg kit, and stove gloves

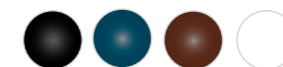

BP BBE BRM IVE



JØTUL F 500 OSLO CF

Showcasing all the features and benefits of our traditional Jøtul F 500 Oslo including front and left side loading capabilities, the Jøtul F 500 Oslo CF (clean face) now offers an unobstructed view of the fire as well.

HEATING CAPACITY: Up to 2,000 sqft
 MAXIMUM HEAT OUTPUT: Up to 70,000 BTU/hr
 EFFICIENCY: LHV 79.88% - HHV 73.94%
 BURN TIME: Up to 9 hrs
 EMISSIONS: 3.2 grams/hr
 LOG SIZE: Up to 24"
 FIREBOX SIZE: 2.54 ft³
 WEIGHT APPROX: 445 lbs
 DIMENSIONS (HXWXD):
 28 1/2" x 28 1/4" x 27 1/4"
 MINIMUM HEARTH DIMENSIONS (W X D)
 54 1/2" x 50 1/2"

ACCESSORIES: Cookplate, blower fan kit, screen, rear heatshield, leg leveler kit, outside air kit, stove top thermometer, short leg kit, and stove gloves

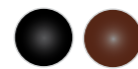

BP BRM



JØTUL F 600 FIRELIGHT CB

This extra large woodstove has long been one of our signature stoves, showcasing our design prowess. Durably built and superbly crafted, the Jøtul F 600 Firelight CB offers both front and right side-loading convenience in a classic design inspired by colonial American furniture.

HEATING CAPACITY: Up to 2,200 sqft
 MAXIMUM HEAT OUTPUT: Up to 81,500 BTU/hr
 EFFICIENCY: LHV 80.16% - HHV 74.18%
 BURN TIME: Up to 9 hrs
 EMISSIONS: 4.1 grams/hr
 LOG SIZE: Up to 24"
 FIREBOX SIZE: 2.97 ft³
 WEIGHT APPROX: 465 lbs
 DIMENSIONS (HXWXD):
 31" x 29" x 26 1/2"
 MINIMUM HEARTH DIMENSIONS (W X D)
 55" x 50"

ACCESSORIES: Blower fan kit, screen, rear heatshield, leg leveler kit, outside air kit, stove top thermometer, and stove gloves



BP BBE



JØTUL F 370

A modern addition to our woodstove line, the Jøtul F 370 showcases innovative features and modern design details. Featuring the industry's first convex triangular cast iron construction and a unique glass panel design, the Jøtul F 370's elegant three-sided fireview will be the focal point of any room.

HEATING CAPACITY: Up to 800 sqft
 MAXIMUM HEAT OUTPUT: Up to 35,000 BTU/hr
 EFFICIENCY: LHV 71.19% - HHV 65.86%
 BURN TIME: Up to 5 hrs
 EMISSIONS: 2.6 grams/hr
 LOG SIZE: Up to 12"
 FIREBOX SIZE: 1.25 ft³
 WEIGHT APPROX: 344 lbs
 DIMENSIONS (HXWXD):
 45 1/2" x 17 1/2" x 18 5/8"
 MINIMUM HEARTH DIMENSIONS (W X D)
 29 1/2" x 33 3/4"

ACCESSORIES: stove top thermometer and stove gloves



BP

QUALITY OF JØTUL ENAMEL

The art of applying a high quality, durable porcelain enamel finish to cast iron begins at the start of the production process by ensuring that the composition of the cast iron is suitable for enameling. With 160 years of experience producing cast iron products and over 50 years of experience applying porcelain enamel to hearth appliances, you can be assured that you'll be enjoying a maintenance free, easy to clean finish for years to come.

The secret behind our remarkable enamel quality is the production process. The moulding process itself is vital to get cast iron of the correct quality, which is a requirement for optimal enamel quality. Before the products are coated with the enamel, they receive one more round of sandblasting to remove oxides and graphite from the surface and to make it rougher so that the enamel can attach itself properly to the cast iron.

Today, we deliver products in different degrees of gloss. Some have a matte finish, others are glossy, and we also offer products with majolica enamel. The common denominator for all the enamelled surfaces is that they are durable and maintenance-free, so that you and your family can enjoy your Jøtul wood or gas stove for generations to come.

Whether you prefer a matte, medium gloss, or a majolica porcelain enamel, there is a finish to suit your taste.

OUR SELECTION OF ENAMELED SURFACES



Blue Black enamel



Brown Majolica enamel



Ivory enamel

JØTUL F 50 TL RANGELEY

TOP LOADING CONVENIENCE

Jøtul's signature cast iron and steel stove, the Jøtul F 50 TL Rangeley, paved the way for what would become Jøtul's line of convection/radiant stoves. Utilizing Jøtul's patented rotating baffle, the Jøtul F 50 TL Rangeley can be easily loaded from the top with the turn of a handle.





JØTUL F 45 GREENVILLE

Immense heat from a medium size stove, the Jøtul F 45 Greenville is the perfect heater for those cold winter nights.

HEATING CAPACITY: Up to 1,500 sqft
 MAXIMUM HEAT OUTPUT: Up to 55,000 BTU/hr
 EFFICIENCY: LHV 80.10% - HHV 74.15%
 BURN TIME: Up to 8 hrs
 EMISSIONS: 2.31 grams/hr
 LOG SIZE : Up to 18" (front to back)
 FIREBOX SIZE: 2.3 ft³
 WEIGHT APPROX: 445 lbs
 DIMENSIONS (HXWXD):
 29 3/4" x 22 3/4" x 27 7/8"
 MINIMUM HEARTH DIMENSIONS (W X D)
 30" x 44"

ACCESSORIES: Fire screen, steel short leg kit (for fireplace installation only), blower fan kit, stove top thermometer, outside air kit, and stove gloves



JØTUL F 50 TL RANGELEY

Leading the way in clean combustion technology, Jøtul now offers the convenience of top-loading in a non-catalytic wood stove. Utilizing Jøtul's patented rotating baffle, the Jøtul F 50 TL Rangeley can be easily loaded from the top with the turn of a handle.

HEATING CAPACITY: Up to 2,300 sqft
 MAXIMUM HEAT OUTPUT: Up to 83,000 BTU/hr
 EFFICIENCY: LHV 77.76% - HHV 71.91%
 BURN TIME: Up to 8 hrs
 EMISSIONS: 2.84 grams/hr
 LOG SIZE : Up to 20"
 FIREBOX SIZE: 2.67 ft³
 WEIGHT APPROX: 569 lbs
 DIMENSIONS (HXWXD):
 30 5/8" x 27 1/4" x 24 1/2"
 MINIMUM HEARTH DIMENSIONS (W X D)
 33" x 40 3/4"

ACCESSORIES: WinterGrill™ kit, fire screen, blower fan kit, stove top thermometer, outside air kit and stove gloves



JØTUL TOP LOADING TECHNOLOGY



Utilizing Jøtul's patented rotating baffle, the Jøtul F 50 TL Rangeley can be easily loaded from the top with the turn of a handle.

JØTUL WINTERGRILL



Turning your Jøtul F 50 TL Rangeley into a fully functioning grill or smoker is quick and easy. Drop in the stainless steel grill, close the top, and get ready to enjoy grilled food any time of the year.



JØTUL F 55 CARRABASSETT

If you are looking for a whole house heater, look no further. The Jøtul F 55 Carrabasset is large enough to be used as a primary heat source and commands up to 10 hours of burn time.

HEATING CAPACITY: Up to 2,300 sqft
MAXIMUM HEAT OUTPUT: Up to 83,000 BTU/hr
EFFICIENCY: LHV 82.37% - HHV 76.23%
BURN TIME: Up to 10 hrs
EMISSIONS: 3.50 grams/hr
LOG SIZE: Up to 18" (front to back)
FIREBOX SIZE: 2.95 ft³
WEIGHT APPROX. 475 LBS
DIMENSIONS (HxWxD):
30 5/8" x 27 1/4" x 24 1/2"
MINIMUM HEARTH DIMENSIONS (W x D)
33" x 40 3/4"

ACCESSORIES: Fire screen, blower fan kit, stove top thermometer, outside air kit, and stove gloves



BP

“WHO SAYS THE GRILLING SEASON
HAS TO END ON LABOR DAY?”



JØTUL C 550 ROCKLAND CB

FLUSH FACE FIREPLACE INSERT

Clean lines and delicate curves frame the magnificent fire view of our large flush face wood burning insert - the Jøtul C 550 Rockland CB. Featuring one of the largest fire viewing areas of any comparably sized wood burning insert, the Jøtul C 550 Rockland CB maximizes heating efficiency and firebox capacity.



JØTUL C 350 WINTERPORT



Jøtul C 350 Winterport with steel wide trim kit (40" W x 30" H)



Jøtul C 350 Winterport with trimable steel surround (37" W x 25 1/2" H)

Jøtul C 350 Winterport standard cast iron surround (37" W x 25 1/4" H) with 2" cast iron plinth (37" W x 27 1/4" H)

Designed specifically for smaller masonry fireplaces and factory built wood fireplaces, the Vesta Design and Technology Award-winning Jøtul C 350 Winterport is our latest innovation in wood insert technology.

HEATING CAPACITY: Up to 1,200 sqft
 MAXIMUM HEAT OUTPUT: Up to 40,000 BTU/hr
 EFFICIENCY: LHV 80.20% - HHV 74.20%
 BURN TIME: Up to 7 hrs.
 EMISSIONS: 4.0 grams/hr
 LOG SIZE: Up to 20"
 FIREBOX SIZE: 1.32 ft³
 WEIGHT APPROX: 425 lbs
 MINIMUM FIREPLACE DIMENSIONS (W x H x D)
 32" x 19 1/2" x 16"
 MINIMUM HEARTH DIMENSIONS (W x D)
 34 1/2" x 16"

ACCESSORIES: Steel wide trim surround, trimable steel surround, and stove gloves



BP

JØTUL C 450 KENNEBEC



Jøtul C 450 Kennebec cast iron surround (40" W x 30 1/4" H)



Jøtul C 450 Kennebec with steel wide trim kit (47 3/4" W x 34" H)



Jøtul C 450 Kennebec with trimable steel surround (40" W x 30" H)

The Jøtul C 450 Kennebec is a medium sized wood insert with a large glass area providing a perfect view of the burning logs. Able to take a log up to 20", the Jøtul C 450 Kennebec is the perfect heater for your hearth and home.

HEATING CAPACITY: Up to 1,400 sqft
 MAXIMUM HEAT OUTPUT: Up to 50,000 BTU/hr
 EFFICIENCY: LHV 78.42% - HHV 72.54%
 BURN TIME: Up to 8 hrs.
 EMISSIONS: 4.4 grams/hr
 LOG SIZE: Up to 20"
 FIREBOX SIZE: 2.05 ft³
 WEIGHT APPROX: 445 lbs
 MINIMUM FIREPLACE DIMENSIONS (W x H x D)
 27 1/2" x 23" x 14-17"
 MINIMUM HEARTH DIMENSIONS (W x D)
 40" x 18"

ACCESSORIES: Steel wide trim surround, trimable steel surround, outside air kit, mantel heatshield, and stove gloves



BP



JØTUL C 450 KENNEBEC CF



Jøtul C 450 Kennebec CF cast iron surround
(40" W x 30 1/4" H)



Jøtul C 450 Kennebec CF with steel wide trim kit (47 3/4" W x 34" H)



Jøtul C 450 Kennebec CF with trimable steel surround
(40" W x 30" H)

The Jøtul C 450 Kennebec CF (clean face) is a medium sized wood insert with a large glass area providing a perfect view of the burning logs. Able to take a log up to 20", the Jøtul C 450 Kennebec is the perfect heater for your hearth and home.

HEATING CAPACITY: Up to 1,400 sqft
 MAXIMUM HEAT OUTPUT: Up to 50,000 BTU/hr
 EFFICIENCY: LHV 78.42% - HHV 72.54%
 BURN TIME: Up to 8 hrs.
 EMISSIONS: 4.4 grams/hr
 LOG SIZE: Up to 20"
 FIREBOX SIZE: 2.05 ft³
 WEIGHT APPROX: 445 lbs
 MINIMUM FIREPLACE DIMENSIONS (W x H x D)
 27 1/2" x 23" x 14-17"
 MINIMUM HEARTH DIMENSIONS (W x D)
 40" x 18"

ACCESSORIES: Outside air kit, steel wide trim surround, trimable steel surround, mantel heatshield, and stove gloves



BP

JØTUL C 550 ROCKLAND CB



Jøtul C 550 Rockland CB cast iron surround
(40" W x 31 5/8" H)



Jøtul C 550 Rockland CB with steel wide trim kit (44" W x 34" H)



Jøtul C 550 Rockland CB with trimable steel surround (40" W x 32" H)

Clean lines and delicate curves frame the magnificent fire view of our large flush face wood burning insert – the Jøtul C 550 Rockland CB. Named after the coastal Maine town of Rockland, the Jøtul C 550 CB is designed to be a whole house heater.

HEATING CAPACITY: Up to 1,700 sqft
 MAXIMUM HEAT OUTPUT: Up to 65,000 BTU/hr
 EFFICIENCY: LHV 77.28% - HHV 71.48%
 BURN TIME: Up to 9 hrs.
 EMISSIONS: 4.5 grams/hr
 LOG SIZE: Up to 24"
 FIREBOX SIZE: 2.08 ft³
 WEIGHT APPROX: 550 lbs
 MINIMUM FIREPLACE DIMENSIONS (W x H x D)
 33" x 23 3/4" x 18"
 MINIMUM HEARTH DIMENSIONS (W x D)
 37" x 16"

ACCESSORIES: Steel wide trim surround, trimable steel surround, and stove gloves



BP



Jøtul Wood Stoves & Inserts

US & Canada Heat Capacity by Zone

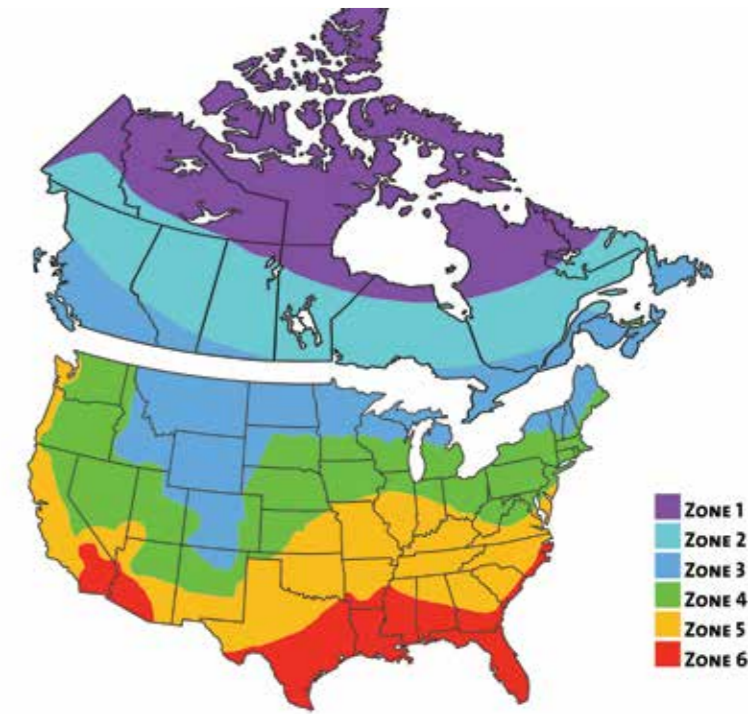

JØTUL C 550 ROCKLAND CB CF



Jøtul C 550 Rockland CB CF cast iron surround (40" W x 31 5/8" H)



Jøtul C 550 Rockland CB CF with steel wide trim kit (44" W x 34" H)



Jøtul C 550 Rockland CB CF with trimable steel surround (40" W x 32" H)

Showcasing all the features and benefits of the traditional Jøtul C 550 Rockland CB, the new Jøtul C 550 Rockland CB CF (clean face) now offers an unobstructed view of the fire as well.

HEATING CAPACITY: Up to 1,700 sqft
 MAXIMUM HEAT OUTPUT: Up to 65,000 BTU/hr
 EFFICIENCY: LHV 77.28% - HHV 71.48%
 BURN TIME: Up to 9 hrs.
 EMISSIONS: 4.5 grams/hr
 LOG SIZE: Up to 24"
 FIREBOX SIZE: 2.08 ft³
 WEIGHT APPROX: 550 lbs
 MINIMUM FIREPLACE DIMENSIONS: (W x H x D)
 33" x 23 3/4" x 18"
 MINIMUM HEARTH DIMENSIONS (W x D)
 37" x 16"

ACCESSORIES: Steel wide trim surround, trimable steel surround, and stove gloves

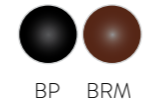

	Max Output BTU/HR	Zone 1 (sq.ft)	Zone 2 (sq.ft)	Zone 3 (sq.ft)	Zone 4 (sq.ft)	Zone 5 (sq.ft)	Zone 6 (sq.ft)
Jøtul F 602 CB	28,000	400	500	600	800	900	1000
Jøtul F 100 Nordic QT	35,000	400	500	600	800	900	1000
Jøtul F 3 CB	42,000	600	800	1000	1200	1300	1500
Jøtul F 45 Greenville	55,000	900	1100	1300	1500	1700	1800
Jøtul F 400 Castine	55,000	900	1100	1300	1500	1700	1800
Jøtul F 118 CB Black Bear	55,000	1100	1200	1400	1500	1900	2000
Jøtul F 500 Oslo	70,000	1400	1600	1800	2000	2200	2300
Jøtul F 50 TL Rangeley	83,000	1700	1900	2100	2300	2500	2600
Jøtul F 55 Carrabassett	83,000	1700	1900	2100	2300	2500	2600
Jøtul F 600 Firelight	81,500	1600	1800	2000	2200	2400	2500
Jøtul F 370	35,000	400	500	600	800	900	1000
Jøtul C 350 Winterport	40,000	600	800	1000	1200	1300	1500
Jøtul C 450 Kennebec	50,000	800	1000	1200	1400	1600	1800
Jøtul C 550 Rockland	65,000	1100	1300	1500	1700	1900	2000

This heating capacity zone chart is to be used as a guideline only. Square footage measurements may differ due to climate, building construction, and location of stove.

TECHNICAL DIMENSIONS

JØTUL F 602 CB - Page 8



Heating Capacity	Up to 800 sq. ft.
Max Heat Output	28,000 BTU/hr
Log Size	Up to 16"
Emissions	3.4 Grams/hr
Burn Time	Up to 5 hrs
Firebox Size	.82 ft ³
Weight	160 lbs
Clearances Top Vent	
Rear	13 1/2"
Side	21"
Corner	13"
Clearances with rear heatshield & double wall chimney connector	
Rear	9"
Side	24"
Corner	9"
Height to top of flue	
Top (26 1/2")	Rear (24 3/4")
Minimum Hearth Dimensions (W x D)	28 1/2" x 45 1/2"

JØTUL F 3 CB - Page 11

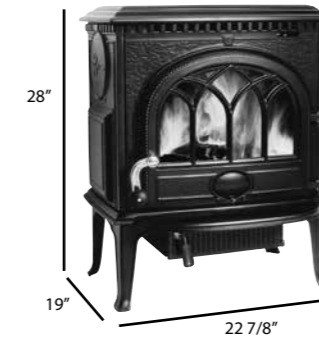

Heating Capacity	Up to 1,200 sq. ft.
Max Heat Output	42,000 BTU/hr
Log Size	Up to 18"
Emissions	3.78 Grams/hr
Burn Time	Up to 7 hrs
Firebox Size	1.17 ft ³
Weight	265 lbs
Clearances Top Vent	
Rear	25"
Side	24"
Corner	18"
Clearances with rear heatshield & double wall chimney connector	
Rear	10"
Side	18"
Corner	14"
Height to top of flue	
Top (28")	Rear (25 1/2")
Minimum Hearth Dimensions (W x D)	39" x 39"

JØTUL F 100 NORDIC QT - Page 9/10



Heating Capacity	Up to 800 sq. ft.
Max Heat Output	35,000 BTU/hr
Log Size	Up to 16"
Emissions	3.0 Grams/hr
Burn Time	Up to 6 hrs
Firebox Size	.85 ft ³
Weight	215 lbs
Clearances Top Vent	
Rear	11"
Side	15"
Corner	10"
Clearances with rear heatshield & double wall chimney connector	
Rear	8"
Side	17"
Corner	10"
Height to top of flue	
Top (24")	Rear (21 3/4")
Minimum Hearth Dimensions (W x D)	37" x 38"

JØTUL F 400 CASTINE - Page 12/13



Heating Capacity	Up to 1,500 sq. ft.
Max Heat Output	55,000 BTU/hr
Log Size	Up to 20"
Emissions	3.77 Grams/hr
Burn Time	Up to 8 hrs
Firebox Size	1.77 ft ³
Weight	375 lbs
Clearances Top Vent	
Rear	25"
Side	19"
Corner	18"
Clearances with rear heatshield & double wall chimney connector	
Rear	7"
Side	15"
Corner	11"
Height to top of flue	
Top (29 1/2")	Rear (28 1/2")
Minimum Hearth Dimensions (W x D)	42" x 44"

JØTUL F 370 - Page 18



Heating Capacity	Up to 800 sq. ft.
Max Heat Output	35,000 BTU/hr
Log Size	Up to 12"
Emissions	2.6 Grams/hr
Burn Time	Up to 5 hrs
Firebox Size	1.25 ft ³
Weight	344 lbs
Clearances Top Vent	
Rear	12"
Side	22"
Corner	16"
Clearances with rear heatshield & double wall chimney connector	
Rear	6"
Side	22"
Corner	16"
Height to top of flue	
Top (45")	Rear (43 1/2")
Minimum Hearth Dimensions (W x D)	29 1/2" x 33 3/4"

JØTUL F 118 CB BLACK BEAR - Page 14



Heating Capacity	Up to 1,500 sq. ft.
Max Heat Output	55,000 BTU/hr
Log Size	Up to 24"
Emissions	3.43 Grams/hr
Burn Time	Up to 8 hrs
Firebox Size	1.47 ft ³
Weight	340 lbs
Clearances Top Vent	
Rear	9"
Side	35"
Corner	26"
Clearances with rear heatshield & double wall chimney connector	
Rear	3 1/2"
Side	18"
Corner	12 1/2"
Height to top of flue	
Top (32")	Rear (30")
Minimum Hearth Dimensions (W x D)	30 1/2" x 53"

Jøtul wood stoves and inserts efficiencies have been EPA tested and certified. HHV value represents a calculation where the water product in the combustion gas is considered in the liquid form while the LHV is calculated with the water product considered in the vapor form. Simply put, HHV assumes all the water component is in a liquid state (condensed) at the end of combustion and that heat recovered from that condensation can be put to use. With that considered the efficiency value for HHV will be lower due to a higher quantity of energy to be considered relative to the appliances measured temperature release. The maximum heat output value is derived from the certification test data and represents a refueling cycle more representative of homeowner usage than that prescribed by the test protocol. The maximum heating efficiency of XX% (either HHV or LHV) was achieved at a burn rate of XXXXX Btu/hr. This value is a component of the weighted average efficiency calculation.

JØTUL F 500 OSLO - Page 15/16

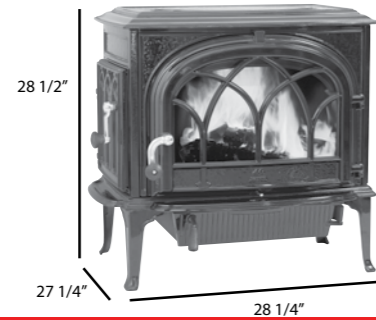

Heating Capacity	Up to 2,000 sq. ft.
Max Heat Output	70,000 BTU/hr
Log Size	Up to 24"
Emissions	3.2 Grams/hr
Burn Time	Up to 9 hrs
Firebox Size	2.54 ft ³
Weight	445 lbs
Clearances Top Vent	
Rear	18"
Side	14"
Corner	13"
Clearances with rear heatshield & double wall chimney connector	
Rear	6"
Side	14"
Corner	9"
Height to top of flue	
Top (28 1/2")	Rear (28 1/4")
Rear w/opt short legs (26")	
Minimum Hearth Dimensions	
54 1/2" x 50 1/2"	

JØTUL F 50 TL RANGELEY - Page 23

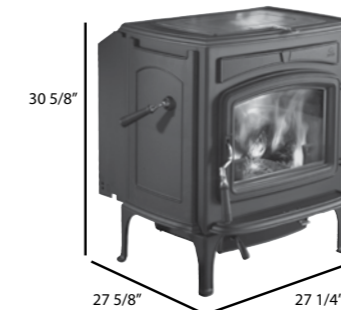

Heating Capacity ¹	Up to 2,300 sq. ft.
Max Heat Output	83,000 BTU/hr
Log Size	Up to 20"
Emissions	2.84 Grams/hr
Burn Time	Up to 8 hrs
Firebox Size	2.67 ft ³
Weight	569 lbs
Clearances Top Vent	
Rear	10" w/FCHS
Side	14"
Corner	12"
Clearances with rear heatshield & double wall chimney connector	
Rear	6"
Side	14"
Corner	12"
Height to top of flue	
Top (30 5/8")	Rear (30")
Minimum Hearth Dimensions	
33" x 40 3/4"	

JØTUL F 600 FIRELIGHT CB - Page 17



Heating Capacity ¹	Up to 2,200 sq. ft.
Max Heat Output	81,500 BTU/hr
Log Size	Up to 24"
Emissions	4.1 Grams/hr
Burn Time	Up to 9 hrs
Firebox Size	2.97 ft ³
Weight	465 lbs
Clearances Top Vent	
Rear	19"
Side	13"
Corner	13"
Clearances with rear heatshield & double wall chimney connector	
Rear	8"
Side	13"
Corner	9"
Height to top of flue	
Top (31 1/2")	Rear (30 1/2")
Minimum Hearth Dimensions (W x D)	
55" x 50"	

JØTUL F 55 CARRABASSETT - Page 25

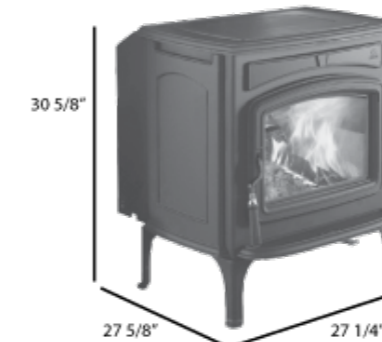

Heating Capacity ¹	Up to 2,300 sq. ft.
Max Heat Output	83,000 BTU/hr
Log Size	Up to 18" front to back
Emissions	3.50 Grams/hr
Burn Time	Up to 10 hrs
Firebox Size	2.95 ft ³
Weight	475 lbs
Clearances Top Vent	
Rear	10" w/FCHS
Side	14"
Corner	12"
Clearances with rear heatshield & double wall chimney connector	
Rear	6"
Side	14"
Corner	12"
Height to top of flue	
Top (30 5/8")	Rear (30")
Minimum Hearth Dimensions (W x D)	
33" x 40 3/4"	

JØTUL F 45 GREENVILLE - Page 22



Heating Capacity ¹	Up to 1,500 sq. ft.
Max Heat Output	55,000 BTU/hr
Log Size	Up to 18"
Emissions	2.31 Grams/hr
Burn Time	Up to 8 hrs
Firebox Size	2.3 ft ³
Weight	445 lbs
Clearances Top Vent	
Rear	10" w FCFS and 16" w/o FCFS
Side	15"
Corner	11"
Clearances with rear heatshield & double wall chimney connector	
Rear	6"
Side	15"
Corner	11"
Height to top of flue	
Top (29 3/4")	Rear (29 1/2")
rear w/opt short legs (26 1/4")	
Minimum Hearth Dimensions (W x D)	
30" x 44"	

JØTUL C 350 WINTERPORT - Page 28

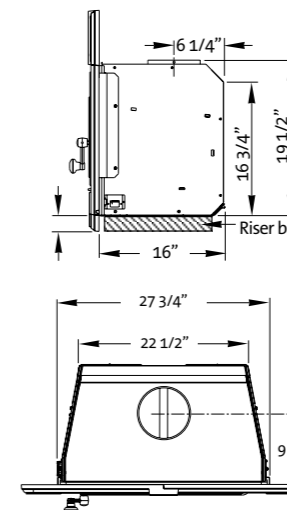

Heating Capacity ¹	Up to 1,200 sq. ft.
Max Heat Output	40,000 BTU/hr
Log Size	Up to 20"
Emissions	4.0 Grams/hr
Burn Time	Up to 7 hrs
Firebox Size	1.32 ft ³
Weight	425 lbs
Minimum Hearth Dimensions (WxD)	
34 1/2" x 16"	
Minimum Fireplace Dimensions (WxHxD)	
32" x 19 1/2" x 16"	
Jøtul C 350 Winterport Classic Cast Iron Surround	
37" wide x 25 1/4" high (27 1/4" High w/plinth)	
Trimable Steel Surround	
37" wide x 25 1/2" high	
Steel Wide Trim Kit	
40" wide x 30" high	

TECHNICAL DIMENSIONS

JØTUL C 450 KENNEBEC - Page 29/30

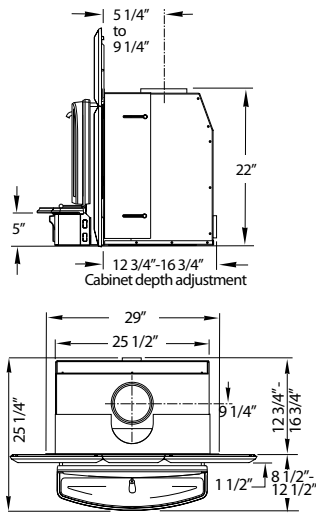

- Heating Capacity¹ Up to 1,400 sq. ft.
- Max Heat Output 50,000 BTU/hr
- Log Size Up to 20"
- Emissions 4.4 Grams/hr
- Burn Time Up to 8 hrs
- Firebox Size 2.05 ft³
- Weight 445 lbs
- Minimum Hearth Dimensions (WxD) 40" x 18"
- Minimum Fireplace Dimensions (WxHxD) 27 1/2" x 23" x 14-17"
- Jøtul C 450 Kennebec Classic Cast Iron Surround 40" wide x 30 1/4" high
- Trimable Steel Surround 40" wide x 30" high
- Steel Wide Trim Kit 47.75" wide x 34" high

JØTUL C 550 ROCKLAND- Page 31/32

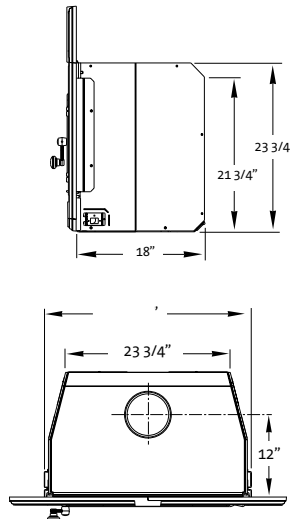

- Heating Capacity¹ Up to 1,700 sq. ft.
- Max Heat Output 65,000 BTU/hr
- Log Size Up to 24"
- Emissions 4.5 Grams/hr
- Burn Time Up to 9 hrs
- Firebox Size 2.08 ft³
- Weight 550 lbs
- Minimum Hearth Dimensions (WxD) 37" x 16"
- Minimum Fireplace Dimensions (WxHxD) 33" x 23 3/4" x 18"
- Jøtul C 550 Rockland Classic Cast Iron Surround 40" wide x 31 5/8" high
- Trimable Steel Surround 40" wide x 32" high
- Steel Wide Trim Kit 44" wide x 34" high

WOOD FIREPLACE INSERT CLEARANCES

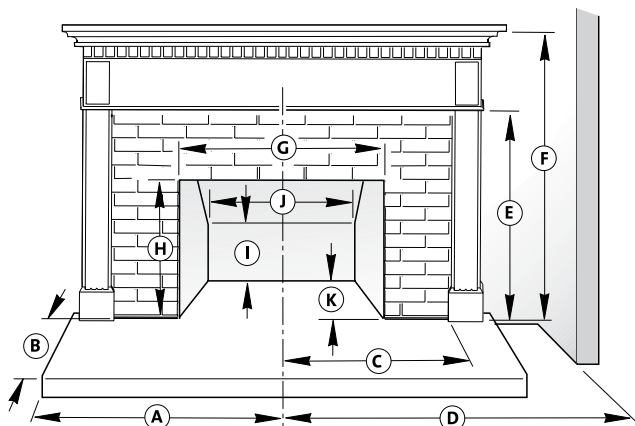

Minimum Dimensions	Jøtul C 350	Jøtul C 450	Jøtul C 550
A: Hearth Width from centerline	17 1/4"	20"	18 1/2"
B: Hearth Depth	16"	18"	16"/20" CAN**
C: To 1" Side Trim from centerline	19 1/2"	22"-27"	(1" to 6") - 23"
D: To Side Wall from centerline	54 1/2"	27"	28"
E: To 1" Top Trim	39"	n/a	39"
F: To 3 1/2" Mantel	48"	39" ¹	40"
To 11 1/2" Mantel	54"	45" ¹	46"
G: Front Opening Width	32"	27 1/2"	33"
H: Lintel Height	19 1/2"	23"	23 3/4"
I: Rear Wall Height	16 3/4"	21 1/2"	22"
J: Rear Wall Width	22 3/4"	25 1/2"	24"
K: Fireplace Depth	16"	14" - 17"	18"

^{*} Add 2" w/ Jøtul C 350 Riser
^{**} Mantel clearance may be reduced by 3" with use of optional Mantel Heat Shield
^{***} 15 1/2" in Canada with 2 1/2" raised hearth extension in code approved masonry fireplace
¹ Mantel clearance may be reduced by 5" in both US and Canada with use of optional Mantel Heat Shield