

# SÓLAS

CONTEMPORARY FIRE

BUILT-IN  
DIRECT VENT  
GAS FIREPLACES

## INSTALLATION & OPERATION MANUAL

SEE-THRU MODELS: BI-48-ST, BI-60-ST, BI-72-ST

SINGLE SIDE MODELS: BI-48-SSL, BI-48-SSR, BI-60-SSL, BI-60-SSR, BI-72-SSL, BI-72-SSR



### WARNING:

#### FIRE OR EXPLOSION HAZARD

Failure to follow safety warnings exactly could result in serious injury, death, or property damage

- Do not store or use gasoline or other flammable vapors and liquids in the vicinity of this or any other appliance.
- **WHAT TO DO IF YOU SMELL GAS**
  - Do not try to light any appliance.
  - Do not touch any electrical switch; do not use any phone in your building.
  - Leave the building immediately
  - Immediately call your gas supplier from a neighbor's phone. Follow the gas supplier's instructions.
  - If you cannot reach your gas supplier, call the fire department.
- Installation and service must be performed by a qualified installer, service agency or the gas supplier.

DUE TO HIGH TEMPERATURES, THE APPLIANCE SHOULD BE LOCATED OUT OF TRAFFIC AND AWAY FROM FURNITURE AND DRAPERIES.

CHILDREN AND ADULTS SHOULD BE ALERTED TO THE HAZARDS OF HIGH SURFACE TEMPERATURE AND SHOULD STAY AWAY TO AVOID BURNS OR CLOTHING IGNITION.

YOUNG CHILDREN SHOULD BE SUPERVISED WHEN THEY ARE IN THE SAME ROOM AS THE APPLIANCE.

CLOTHING OR OTHER FLAMMABLE MATERIAL SHOULD NOT BE PLACED ON OR NEAR THE APPLIANCE.

KEEP THE ROOM AREA CLEAR AND FREE FROM COMBUSTIBLE MATERIALS, GASOLINE, AND OTHER FLAMMABLE VAPORS AND LIQUIDS.

WARNING: Improper installation, adjustment, alteration, services or maintenance can cause injury or property damage. Refer to this manual. For assistance or additional information, consult a qualified installer, service agency or the gas supplier.

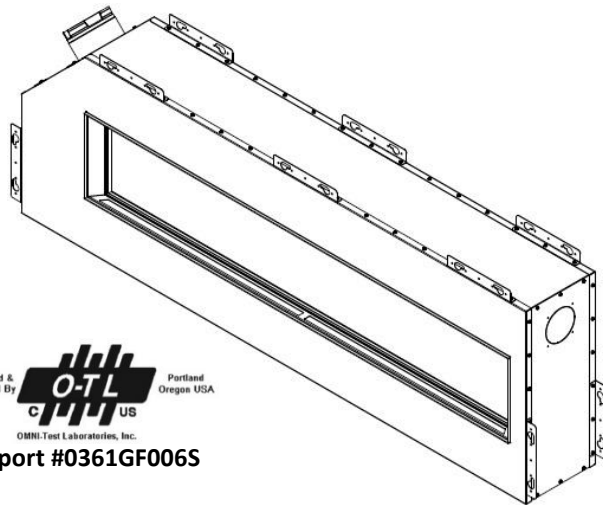

Report #0361GF006S

Ce manuel est disponible en Francais sur demande.

This appliance may be installed in an aftermarket, permanently located, manufactured home (USA only) or mobile home, where not prohibited by local codes.

This appliance is only for use with the type of gas indicated on the rating plate. This appliance is not convertible for use with other gases, unless a certified kit is used.



# DANGER



**HOT GLASS WILL  
CAUSE BURNS.**

**DO NOT TOUCH GLASS  
UNTIL COOLED.**

**NEVER ALLOW CHILDREN  
TO TOUCH GLASS.**

**A barrier designed to reduce the risk of burns from the hot viewing glass is provided with this appliance and shall be installed for the protection of children and other at-risk individuals.**

**INSTALLER:** Leave this manual with the appliance | **CONSUMER:** Retain this manual for future reference



# TABLE OF CONTENTS

Important Safety Information	4
Model Descriptions	6
Specifications	7
Clearances	10
Installation Information	13
Venting	15
Final Assembly	21
Lighting & Operation	24
Remote Handset Operation	26
Gas Conversion	33
Maintenance	35
Maintenance Log	36
Replacement Parts List	38
Control Schematic	39
Installation Record	40
Warranty Information	41

WE STRONGLY SUGGEST THAT YOU READ THIS MANUAL THOROUGHLY BEFORE BEGINNING THE INSTALLATION OF THE DIRECT VENT GAS FIREPLACE. ALTHOUGH THE BASIC REQUIREMENTS FOR THE INSTALLATION OF ALL DIRECT VENT GAS FIREPLACES ARE SIMILAR, EACH SPECIFIC PRODUCT HAS ITS OWN UNIQUE SET-UP AND INSTALLATION REQUIREMENTS THAT MUST BE FOLLOWED EXACTLY. PLAN YOUR INSTALLATION IN ADVANCE BY CAREFULLY RE-VIEWING ALL THE INFORMATION CONTAINED IN THIS MANUAL.

**AVERTISSEMENT: Assurez-vous de bien suivre les instructions données dans cette notice pour réduire au minimum le risque d'incendie ou d'explosion ou pour éviter tout dommage matériel, toute blessure ou la mort.**

- Ne pas entreposer ni utiliser d'essence ni d'autres vapeurs ou liquides inflammables dans le voisinage de cet appareil ou de tout autre appareil.

- QUE FAIRE SI VOUS SENTEZ UNE ODEUR DE GAZ:

- Ne pas tenter d'allumer d'appareil.
- Ne touchez à aucun interrupteur. Ne pas vous servir des téléphones se trouvant dans le bâtiment où vous trouvez.
- Appelez immédiatement votre fournisseur de gaz depuis un voisin. Suivez les instructions du fournisseur.
- Si vous ne pouvez rejoindre le fournisseur de gaz, appelez le service des incendies.

- L'installation et l'entretien doivent être assurés par un installateur ou un service d'entretien qualifié ou par le fournisseur de gaz.

Cet appareil peut être installé dans une maison préfabriquée (mobile) déjà installée à demeure si les règlements locaux le permettent.

Cet appareil doit être uniquement avec le type de gaz indiqué sur la plaque signalétique. Cet appareil ne peut être converti à d'autres gaz, sauf si une trousse de conversion est utilisée.

Ne pas utiliser cet appareil s'il a été plongé, même partiellement, dans l'eau. Appeler un technicien qualifié pour inspecter l'appareil et remplacer toute partie du système de commande et toute commande qui a été plongée dans l'eau.

Attention. Au moment de l'entretien des commandes, étiquetez tous les fils avant de les débrancher. Des erreurs de câblage peuvent entraîner un fonctionnement inadéquat et dangereux.

S'assurer que l'appareil fonctionne adéquatement une fois l'entretien terminé.

**AVERTISSEMENT.** Ne pas utiliser l'appareil si le panneau frontal en verre n'est pas en place, est craqué ou brisé. Confiez le remplacement du panneau à un technicien agréé.

**INSTALLATEUR:** Laissez cette notice avec l'appareil.  
**COMSOMMATEUR:** Conservez cette notice pour consultation ultérieure.

# IMPORTANT SAFETY INFORMATION

The installation must conform with local codes or, in the absence of local codes, with the National Fuel Gas Code, ANSI Z223.1/NFPA 54, or the Natural Gas and Propane Installation Code, CSA B149.1.

A manufactured home (USA only) or mobile home OEM installation must conform with the Manufactured Home Construction and Safety Standard, Title 24 CFR, Part 3280 or when such a standard is not applicable, the Standard for Manufactured Home Installations, ANSI/BCSBCS A225.1, or Standard for Gas Equipped Recreational Vehicles and Mobile Housing, CSA Z240.4.

The appliance and its appliance main gas valve must be disconnected from the gas supply piping system during any pressure testing of that system at test pressures in excess of 1/2 psi (3.5 kPa).

The appliance must be isolated from the gas supply piping system by closing its equipment shutoff valve during any pressure testing of the gas supply piping system at test pressures equal to or less than 1/2 psi (3.5 kPa).

The installation must provide for adequate ventilation air to the appliance.

This gas appliance must not be connected to a chimney flue serving a separate solid-fuel burning appliance.

The appliance, when installed, must be electrically grounded in accordance with local codes, or, in the absence of local codes, with the National Electrical Code ANSI/NFPA 70, or the Canadian Electrical Code, CSA C22. 1.

The appliance area must be kept clear and free from combustible materials, gasoline and other flammable vapors and liquids.

The flow of combustion and ventilation air must not be obstructed. Adequate accessibility clearances must be maintained for servicing and proper operation of this appliance.

Do not use this appliance if any part has been under water. Immediately call a qualified service technician to inspect the appliance and to replace any part of the control system and any gas control which has been under water.

**Due to high temperatures, the appliance should be located out of traffic and away from furniture and draperies.**

**Children and adults should be alerted to the hazards of high surface temperatures and should stay away to avoid burns or clothing ignition.**

**Young children should be carefully supervised when they are in the same room as the appliance. Toddlers, young children and others may be susceptible to accidental contact burns. A physical barrier is recommended if there are at-risk individuals in the house. To restrict access to a fireplace or stove, install an adjustable safety gate to keep toddlers, young children and other at-risk individuals out of the room and away from hot surfaces.**

**A barrier designed to reduce the risk of burns from the hot viewing glass is provided with this appliance and shall be installed for the protection of children and other at-risk individuals.**

**If the barrier becomes damaged, the barrier shall be replaced with the manufacturer's barrier for this appliance.**

**Clothing or other flammable material should not be placed on or near the appliance.**

**Any screen or guard removed for servicing an appliance must be replaced prior to operating the appliance.**

# IMPORTANT SAFETY INFORMATION

**Installation and repair should be done by a qualified service person. The appliance should be inspected before use and at least annually by a professional service person. More frequent cleaning may be required due to excessive lint from carpeting, bedding material, etc. It is imperative that the control compartments, burners and circulating air passageways of the appliance be kept clean.**

WARNING: Do not operate the appliance with the glass door assembly removed, or if the glass is cracked or broken. Replacement of the glass should be done by a qualified service person.

WARNING: Use only glass assembly, P/N 48-510 which includes the glass panel, frame and gasket. Do not use substitute materials. Do not strike or slam the glass front. Do not use abrasive cleaners. Do not clean when hot.

CAUTION: DO NOT OPERATE WITH BROKEN GLASS

Installation and repair should be done by a qualified service person. The appliance should be inspected before use and at least annually by a professional service person. More frequent cleaning may be required due to excessive lint from carpeting, bedding material, etc. It is imperative that the control compartment, burners and circulating air passageways of the appliance be kept clean.

## Note:

Periodically conduct a visual check to ensure the pilot and burner flames are as shown (right).

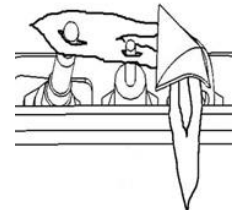

## Vent Installation Note:

When the first piece of Directvent pipe is attached to the starter collar of the fireplace, be sure to inspect both the inside and outside joints to ensure a secure fit with no air gaps. Once it is confirmed there are no gaps, rotate the pipe clockwise to lock it in place. Follow the vent manufacture's installation instructions during vent pipe installation.



# MODEL DESCRIPTIONS

## **FORTY8 SEE-THRU**

MODEL NO. BI-48-ST

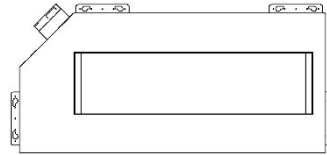

## **FORTY8 SINGLE SIDE FIREPLACE**

(Left side vent exit.)

MODEL NO. BI-48-SSL

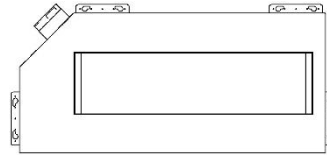

## **FORTY8 SINGLE SIDE FIREPLACE**

(Right side vent exit.)

MODEL NO. BI-48-SSR

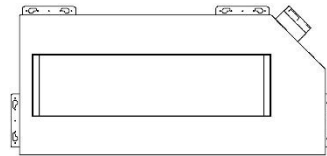

## **SIXTY0 SEE-THRU**

MODEL NO. BI-60-ST

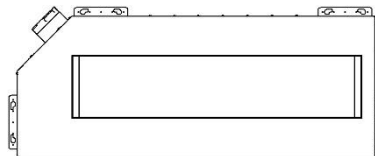

## **SIXTY0 SINGLE SIDE FIREPLACE**

(Left side vent exit.)

MODEL NO. BI-60-SSL

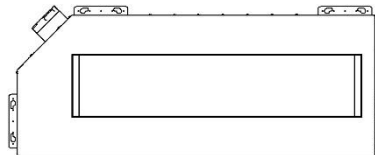

## **SIXTY0 SINGLE SIDE FIREPLACE**

(Right side vent exit.)

MODEL NO. BI-60-SSR

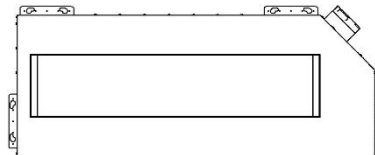

## **SEVENTY2 SEE-THRU**

MODEL NO. BI-72-ST

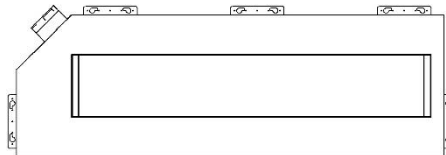

## **SEVENTY2 SINGLE SIDE FIREPLACE**

(Left side vent exit.)

MODEL NO. BI-72-SSL

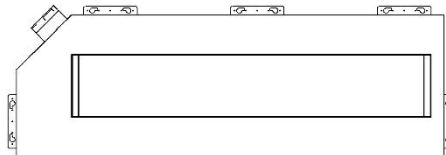

## **SEVENTY2 SINGLE SIDE FIREPLACE**

(Right side vent exit.)

MODEL NO. BI-72-SSR

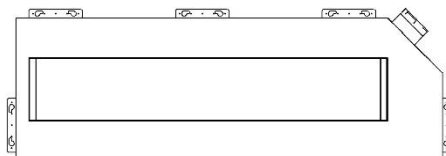

# SPECIFICATIONS

## CERTIFICATION

This appliance has been certified by OMNI-Test Laboratories, Inc. to ANSI Z21.88-2014/CSA 2.33-2014 Vented Gas Fireplace Heaters and CAN/CGA-2.17-M91 (R2014), Gas-Fired Appliances for Use At High Altitudes.

This SÓLAS Gas Fireplace is approved for installation at elevations up to 2000 feet in the U.S. and 1370 meters (4500 feet) in Canada without change. If your installation is at an elevation greater than these, consult with the local authority having jurisdiction for gas product installations to determine their specific requirements for high altitude installations.

These appliances are approved for installation in the Commonwealth of Massachusetts by the Board of State Examiners of Plumbers and Gas Fitters.

**SÓLAS – DIRECT VENT GAS FIREPLACES**

VENTED GAS FIREPLACE HEATER  
NOT FOR USE WITH SOLID FUEL. SERIAL NUMBER: SOLASFIRES.COM

SÓLAS FORTY8	BI-48-ST	BI-48-SSL	BI-48-SSR		
<b>EQUIPPED FOR -</b>	<input type="checkbox"/> Natural Gas/Gaz Naturel	<input type="checkbox"/> Propane		<b>- ÉQUIPÉ POUR</b>	
Input Rating	26,000 BTU/hr	30,000 BTU/hr		Debit Calorifique	
Min. Input Rating	16,000 BTU/hr	19,000 BTU/hr		Puissance Minimum	
Orifice - DMS	#42	#52		L'injecteur	
Manifold Pressure	3.5" w.c. / 1.0kPa	10.0" w.c. / 2.8kPa		Press. A la tubulure	
Min. Supply Pressure	5.5" w.c. / 1.4kPa	11.0" w.c. / 2.8kPa		Press. D'Arrivée Min.	
Max Supply Pressure	10.0" w.c. / 2.5kPa	13.0" w.c. / 3.3kPa		Press. D'Arrivée Max.	

For use only with barrier(s) Part No. 11223. Follow installation instructions.

A utiliser uniquement avec des barrière(s) Référence 11223. Suivez les instructions d'installation.

---

SÓLAS SIXTY0	BI-60-ST	BI-60-SSL	BI-60-SSR		
<b>EQUIPPED FOR -</b>	<input type="checkbox"/> Natural Gas/Gaz Naturel	<input type="checkbox"/> Propane		<b>- ÉQUIPÉ POUR</b>	
Input Rating	30,000 BTU/hr	34,000 BTU/hr		Debit Calorifique	
Min. Input Rating	21,000 BTU/hr	25,000 BTU/hr		Puissance Minimum	
Orifice - DMS	#49	#56		L'injecteur	
Manifold Pressure	3.5" w.c. / 1.0kPa	10.0" w.c. / 2.8kPa		Press. A la tubulure	
Min. Supply Pressure	5.5" w.c. / 1.4kPa	11.0" w.c. / 2.8kPa		Press. D'Arrivée Min.	
Max Supply Pressure	10.0" w.c. / 2.5kPa	13.0" w.c. / 3.3kPa		Press. D'Arrivée Max.	

For use only with barrier(s) Part No. 11218. Follow installation instructions.

A utiliser uniquement avec des barrière(s) Référence 11218. Suivez les instructions d'installation.

---

SÓLAS SEVENTY2	BI-72-ST	BI-72-SSL	BI-72-SSR		
<b>EQUIPPED FOR -</b>	<input type="checkbox"/> Natural Gas/Gaz Naturel	<input type="checkbox"/> Propane		<b>- ÉQUIPÉ POUR</b>	
Input Rating	34,000 BTU/hr	40,000 BTU/hr		Debit Calorifique	
Min. Input Rating	27,000 BTU/hr	28,000 BTU/hr		Puissance Minimum	
Orifice - DMS	#46	#55		L'injecteur	
Manifold Pressure	3.5" w.c. / 1.0kPa	10.0" w.c. / 2.8kPa		Press. A la tubulure	
Min. Supply Pressure	5.5" w.c. / 1.4kPa	11.0" w.c. / 2.8kPa		Press. D'Arrivée Min.	
Max Supply Pressure	10.0" w.c. / 2.5kPa	13.0" w.c. / 3.3kPa		Press. D'Arrivée Max.	

For use only with barrier(s) Part No. 11226. Follow installation instructions.

A utiliser uniquement avec des barrière(s) Référence 11226. Suivez les instructions d'installation.

---

**MINIMUM CLEARANCES TO COMBUSTIBLE CONSTRUCTION**  
**DISTANCES MINIMALES PAR RAPPORT AUX MATÉRIAUX INFLAMMABLES**

FIREPLACE SIDES	4" (102mm)	FOYER CÔTÉS
FIREPLACE TOP	4" (102mm)	FOYER TOP
FIREPLACE FLOOR*	1/2" (13mm)	FOYER DE CHAUSSEE*
FIREPLACE BACK (SINGLE SIDED)	2" (51mm)	FOYER RETOUR (UNIQUE CÔTE)
FIREPLACE BACK (SEE-THRU)	12" (305mm)	FOYER RETOUR (VOIR-PAR)
FIREPLACE FRONT	12" (305mm)	FOYER AVANT
CLEARANCE AROUND VENT PIPE	1.5' (38mm)	JEU AUTOUR VENT PIPE

\*1/2" non-combustible under fireplace floor must have R factor of no less than 0.37  
\*13mm non-combustible sous cheminée plancher doit avoir facteur R de pas moins de 0.37

---

This product has been certified by OMNI-Test Laboratories to ANSI Z21.88-2014 / CSA 2.33-2014 Vented Gas Fireplace Heaters, and CAN/CGA 2.17-M91 (2014), Gas-Fired Appliances For Use At High Altitudes. This appliance is equipped only for altitudes from 0-2000 feet (0-610m). In Canada 0-4500 feet (0-1370m). This appliance must be installed in accordance with local codes, if any; if none, follow the National Fuel Gas Code, ANSI Z223.1/NFPA 54, or Natural Gas and Propane Installation Codes, CSA-B149.1.

This appliance is for use only with the type of gas indicated on the rating plate. This appliance may be installed in an aftermarket, permanently located manufactured home (USA only) or in a mobile home, where not prohibited by local codes. See Owner's Manual for details.

This appliance is not field convertible for use with other gases, unless a certified conversion kit is used.

This appliance may be recessed 12.5 inches within combustible construction.

This appliance may be installed with a combustible mantle of no more than 12 inches deep at a minimum of 14.25 inches above the fireplace opening.

NOT FOR USE WITH GLASS DOORS.

HRD-750 – Heat Redistribution Blower Kit may be used with this appliance.

**SÓLAS – VENT FREE GAS FIREPLACE**

**CAUTION:** HOT WHILE IN OPERATION. DO NOT TOUCH. SEVERE BURNS MAY RESULT. KEEP CHILDREN, CLOTHING, FURNITURE, GASOLINE, AND OTHER LIQUIDS HAVING FLAMMABLE VAPORS AWAY.

**CAUTION:** Do not operate the appliance with the glass removed, cracked, or broken. Replacement of the glass panel(s) should be done by a licensed or qualified service person. See the Owner's Manual.

**CAUTION:** Label all wires prior to disconnection when servicing. Wiring errors can cause improper and dangerous operation. Verify Proper operation after servicing.

Electrical rating – Total input of all components is less than 2.5 amperes.

WARNING: Improper installation, adjustment, alteration, service, or maintenance can cause injury or property damage. Refer to the owner's information manual provided with this appliance. For assistance or additional information, consult a qualified installer, service agency, or the gas supplier.

This appliance must be properly connected to a venting system in accordance with the manufacturer's installation instructions.

Keep burner and control compartments clean. See installation and operating instructions accompanying appliance.

This vented fireplace is not for use with air filters.

---

Ce produit a été testé et répertorié OMNI-Test Laboratories conformément au ANSI Z21.88-2014 - CSA 2.33-2014, CAN/CGA 2.17-M91 (2014), et CSA P 4.1-09. Cet appareil peut être utilisé à des altitudes comprises entre 0 et 610m (0 et 2000 pieds) (E.U. seulement) ou entre 0 et 1370m (0 et 4500 pieds) (Canada seulement) sans modification. Installez l'appareil selon les codes ou règlements, ou dans l'absence de tels règlements, selon les codes d'installation, ANSI Z223.1 National Fuel Gas Code, ou CSA-B149.1 en vigueur. Cet appareil doit être correctement raccordé à un système d'évacuation conformément aux instructions du fabricant.

Cet appareil peut être installé dans une maison préfabriquée (E.-U. seulement) ou mobile déjà installée à demeure si les règlements locaux le permettent. Voir la notice de l'utilisateur pour plus de renseignements. Cet appareil doit être utilisé uniquement avec les types de gaz indiqués sur la plaque signalétique. Cet appareil ne peut pas être utilisé avec d'autres gaz sauf si une trousse de conversion certifiée est fournie.

Cet appareil peut être encastré 318mm au sein de construction combustible.

Cet appareil peut être installé avec un manteau combustible de pas plus de 305mm de profondeur à un minimum de 362 au-dessus de l'ouverture du foyer.

NE PAS UTILISER AVEC PORTES EN VERRE

HRD-750 – Heat Redistribution Blower Kit peut être utilisé avec cet appareil.

---

**ATTENTION:** L'appareil est chaud lorsqu'il fonctionne. Ne pas toucher l'appareil. Risque de brûlures graves surveillez les enfants. Garder les vêtements, les meubles, l'essence ou autres liquides produisant des vapeurs inflammables loin de l'appareil.

AVERTISSEMENT: Une installation, un réglage, une modification, une réparation ou un entretien mal effectué peut causer des dommages matériels ou des blessures. Voir la notice de l'utilisateur qui accompagne l'appareil. Pour de l'aide ou des renseignements supplémentaires, consultez un installateur, un technicien agréé ou le fournisseur de gaz.

---

**ATTENTION:** Avant de faire des réparations, marquez tous les fils avant de les débrancher. Les erreurs avec le circuit électronique peuvent causer des fonctionnements dangereux et incorrects.

**ATTENTION:** Ne pas utiliser l'appareil si le panneau frontal en verre n'est pas en-place, est craqué ou brisé. Confiez le remplacement de panneau à un technicien agréé.

S'assurer que le brûleur et le compartiment des commandes sont propres. Voir les instructions d'installation et d'utilisation qui accompagnent l'appareil.

Ne pas utiliser de filtre à air avec ce foyer au gaz évacuation.

---



Rapport #0361GF006S

FABRIQUÉ PAR:  
Progressive Manufacturing Inc.  
4 Technology Drive, Suite 5  
West Lebanon, NH 03784  
U.S.A.

SOLASFIRES.COM

Sample Rating Label (affixed to control panel within firebox)



# SPECIFICATIONS

## NATURAL GAS SPECIFICATION CHART

<b>INPUT</b>	FORTY <sup>8</sup>	SIXTY <sup>0</sup>	SEVENTY <sup>2</sup>
Input Rating BTU/Hr.	26,000	30,000	34,000
Min. Input BTU/Hr.	16,000	21,000	27,000
Orifice Size - DMS	#42	#49	#46
<b>GAS SUPPLY</b>	FORTY <sup>8</sup>	SIXTY <sup>0</sup>	SEVENTY <sup>2</sup>
Manifold Pressure	3.5" w.c. / 0.9kPa	3.5" w.c. / 0.9kPa	3.5" w.c. / 0.9kPa
Min. Supply Pressure	5.5" w.c. / 1.4kPa	5.5" w.c. / 1.4kPa	5.5" w.c. / 1.4kPa
Max. Supply Pressure	10.0" w.c. / 2.5kPa	10.0" w.c. / 2.5kPa	10.0" w.c. / 2.5kPa

## PROPANE (LP) SPECIFICATION CHART

<b>INPUT</b>	FORTY <sup>8</sup>	SIXTY <sup>0</sup>	SEVENTY <sup>2</sup>
Input Rating BTU/Hr.	30,000	34,000	40,000
Min. Input BTU/Hr.	19,000	25,000	28,000
Orifice Size - DMS	#52	#56	#55
<b>GAS SUPPLY</b>	FORTY <sup>8</sup>	SIXTY <sup>0</sup>	SEVENTY <sup>2</sup>
Manifold Pressure	10.0" w.c. / 2.5kPa	10.0" w.c. / 2.5kPa	10.0" w.c. / 2.5kPa
Min. Supply Pressure	11.0" w.c. / 2.8kPa	11.0" w.c. / 2.8kPa	11.0" w.c. / 2.8kPa
Max. Supply Pressure	13.0" w.c. / 3.3kPa	13.0" w.c. / 3.3kPa	13.0" w.c. / 3.3kPa

<b>Efficiency NG/LP</b>	FORTY <sup>8</sup>	SIXTY <sup>0</sup>	SEVENTY <sup>2</sup>
*Typical Installation, Steady State Efficiency - %	62.2/68.4	69/73.9	72.6/76.4
Steady State Efficiency - %	61/63.4	64.8/70.8	70.4/74.8
Annual Fuel Utilization Efficiency (AFUE) - %	59/61.4	62.8/68.6	68.2/72.5
Canadian p.4 Efficiency - %	65.7/62	64.5/67.7	69.8/72.7

*\*Your efficiency will increase with the length of the vent run. The typical installation tested is 5ft vertical and 5ft horizontal.*

**NOTE: The maximum achievable steady state efficiency can vary depending on how the fireplace is installed and operated.**

- It is recommended that the pilot flame be turned off if the appliance will not be in use for an extended period of time.
- This appliance is equipped for use with the fuel type indicated on the rating plate. Field conversion is only permitted with a conversion kit supplied by SÓLAS.

# SPECIFICATIONS

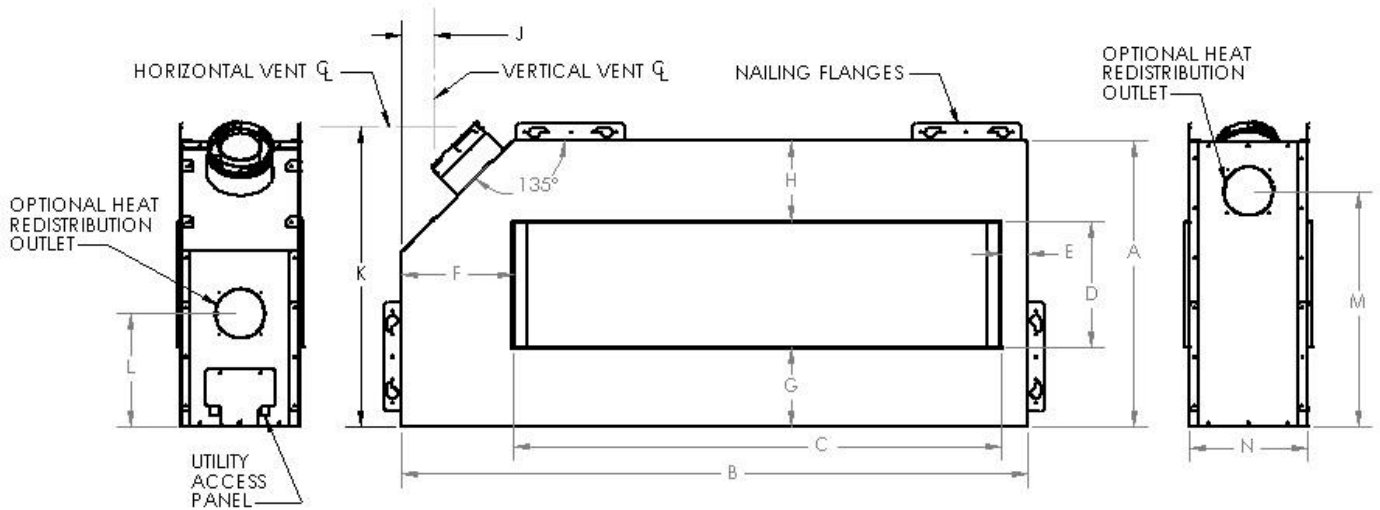

	FORTY8	SIXTY0	SEVENTY2
Dimension "A"	29" (737mm)	29" (737mm)	29" (737mm)
Dimension "B"	63.625" (1,616mm)	73.625" (1,870mm)	87.625" (2,226mm)
Dimension "C"	49.25" (1,251mm)	59.25" (1,505")	73.25" (1,861mm)
Dimension "D"	12.75" (324mm)	12.75" (324mm)	12.75" (324mm)
Dimension "E"	2.70" (69mm)	2.70" (69mm)	2.70" (69mm)
Dimension "F"	11.30" (287mm)	11.30" (287mm)	11.30" (287mm)
Dimension "G"	7.95" (202mm)	7.95" (202mm)	7.95" (202mm)
Dimension "H"	8.125" (206mm)	8.125" (206mm)	8.125" (206mm)
*Dimension "J"	3.25" (83mm)	3.25" (83mm)	3.25" (83mm)
*Dimension "K"	30.25" (768.5mm)	30.25" (768.5mm)	30.25" (768.5mm)
Dimension "L"	11.50" (292mm)	11.50" (292mm)	11.50" (292mm)
Dimension "M"	23.875" (606.5mm)	23.875" (606.5mm)	23.875" (606.5mm)
Dimension "N"	12" (305mm)	12" (305mm)	12" (305mm)

\*The Horizontal and Vertical vent centerline dimensions\* account for the use of a 45-degree elbow.

The gas fireplace is shipped with a 3/8" tube OD (female) connection. The gas supply piping should have a separate gas shutoff valve and a 1/8" NPT plugged tapping upstream of the valve. The stove and its main control valve must be disconnected from the gas supply piping system during any pressure testing of that system at test pressures in excess of 1/2 psi (3.5 kPa). The stove must be isolated from the gas supply piping system by closing the main control valve during any pressure testing of the gas supply system at test pressures equal to or greater than 1/2 psi (3.5 kPa). After the gas supply has been connected, use a commercial gas leak detector or apply a soapy water solution to all the fittings to check for gas leaks. Never use a flame to test for leaks.

# CLEARANCES

MINIMUM CLEARANCES TO COMBUSTIBLE CONSTRUCTION			
	FORTY8	SIXTY0	SEVENTY2
Sides	4" (102mm)	4" (102mm)	4" (102mm)
Floor	1/2" (13mm)	1/2" (13mm)	1/2" (13mm)
Back (Single Sided)	2" (51mm)	2" (51mm)	2" (51mm)
Back (See-Thru)	12" (305mm)	12" (305mm)	12" (305mm)
Front	12" (305mm)	12" (305mm)	12" (305mm)
Clearance around vent pipe	1.5" (38mm)	1.5" (38mm)	1.5" (38mm)

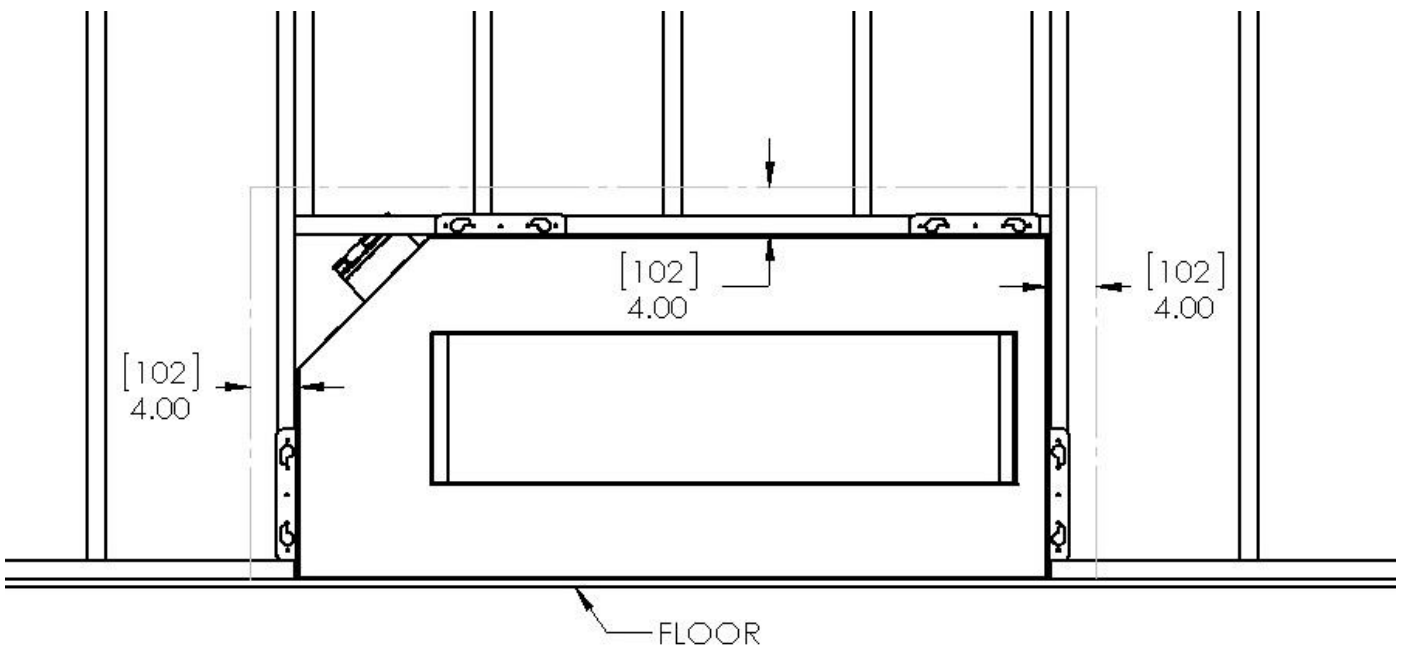

The image above shows a typical installation.

- All framing, finishing, and construction materials that fall within 4" (102mm) of either the sides or top of the fireplace must be non-combustible and 1/2" below the unit.
- Any materials that cover the front face or rear face of the fireplace must be non-combustible. Allow clearance for removal of fireplace trim, screen, and glass.
- The fireplace must be secured to the framing studs using the nailing flanges as shown above. Use 2 screws or nails per nailing flange to secure the fireplace.
- The sheet metal face of this fireplace must be covered by a non-combustible material, it may not be left exposed.
- The floor the fireplace immediately rests on must be constructed of non-combustible material with an R factor of at least .37, with a minimum thickness of 1/2" (13mm).

# CLEARANCES

## FRAMING BEFORE INSTALLATION

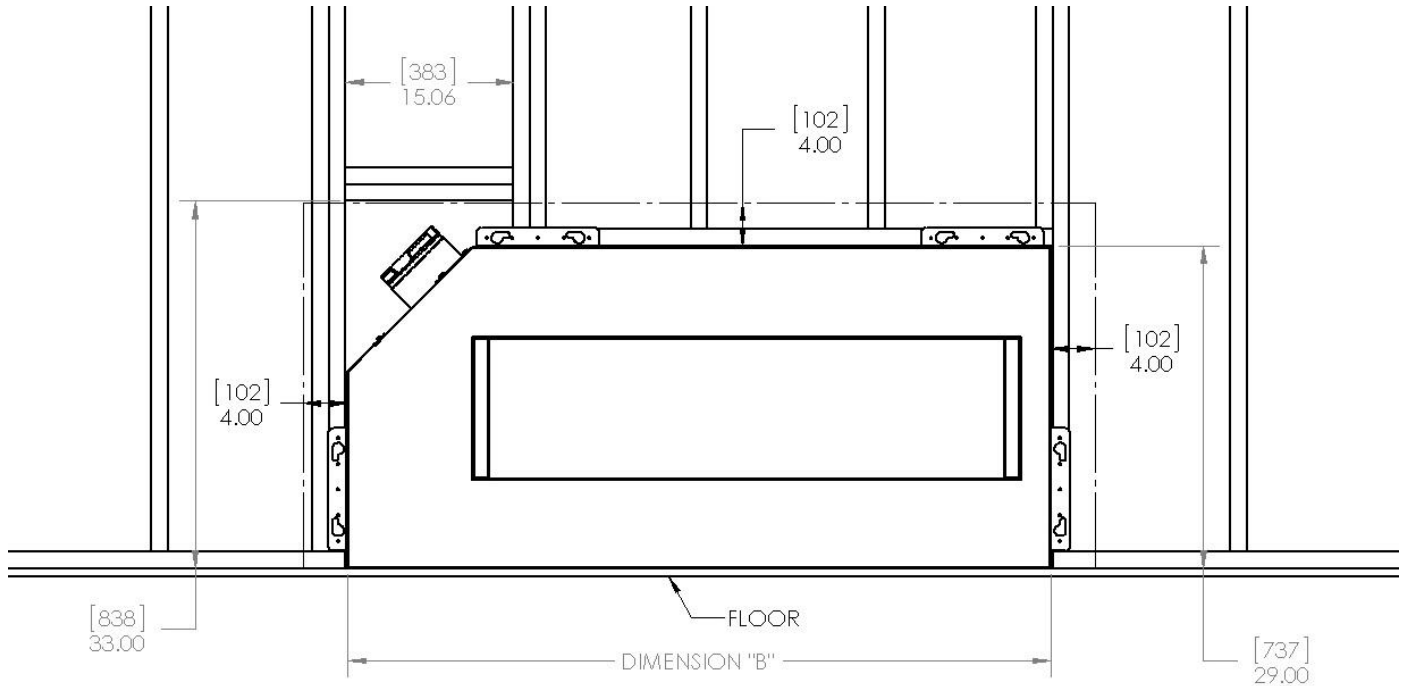

Sometimes it is necessary to frame the location you will be installing the fireplace before the fireplace is onsite, the above image shows an example of how to frame the wall before the fireplace is moved into position.

- All framing, finishing, and construction materials that fall within 4" (102mm) of either the sides or top of the fireplace must be non-combustible. (shown with a dashed line in the image above)
- Note that the vent starter collar sits slightly above the top surface of the fireplace can, there must be clearance to allow the fireplace with starter collar to slide into place.
- The floor the fireplace immediately rests on must be constructed of non-combustible material with an R factor of at least .37, with a minimum thickness of ½" (13mm).
- This framing guide is just an example of the many ways in which a SÓLAS Fireplace can be installed. You may need to customize this framing design to allow for things such as doors, windows, countertops, structural frame members or local code requirements.
- Dimension "B" for your model can be found on page 8.

# CLEARANCES

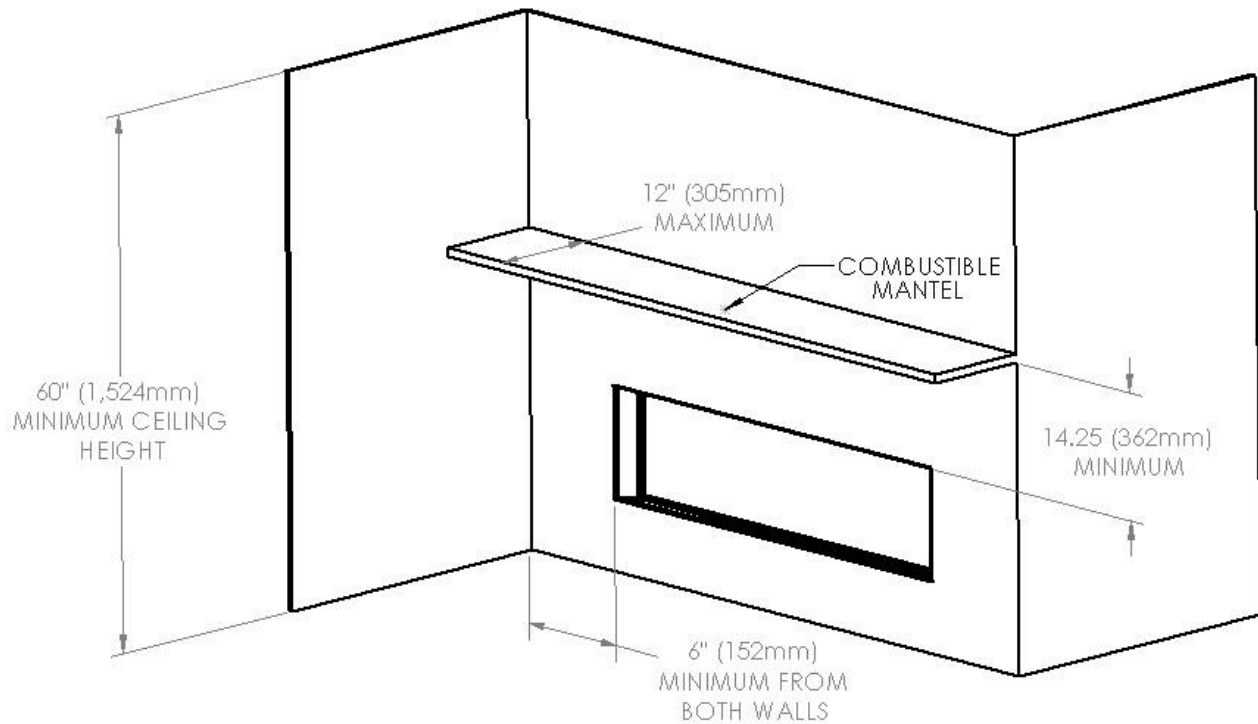

## WARNING

Follow these instructions carefully to ensure safe installation.  
Failure to follow instructions exactly can create a fire hazard.

- The combustible area above the facing must not protrude more than  $\frac{3}{4}$  (19mm) from the facing; if it does, it is considered a mantel and must meet the mantel requirements on the following page.
- When selecting non-combustible materials for use in the installation, take note of the material's propensity to absorb and conduct heat. Materials such as metal, stone, and ceramics may transmit heat more readily than other building materials.
- Only non-combustible materials (i.e. brick, tile, slate, steel, or other man made materials with a UL fire rating of Zero) may be used in the construction and installation of this fireplace. Any material must be fastened to surrounding framing. NOT to the face of the fireplace.

## ATTENTION:

Before proceeding with your installation, determine if you plan to use either the Power Vent kit (PV-800HZ) or the Heat Redistribution Kit (HRD-750). Read the manual for these optional components before proceeding with your installation, as your installation requirements and procedure may change.

# INSTALLATION INFORMATION

## WARNING

Read all instructions completely and thoroughly before attempting installation. Failure to do so could result in serious injury, property damage, or loss of life. Operation of improperly installed or maintained venting system could result in serious injury, property damage, or loss of life.

## NOTE:

Any electrical wiring, gas plumbing, or vent installation required by the appliance must be done prior to final finishing. The unit shall be test burned on high for at least 30 minutes prior to final finishing to confirm proper operation. Failure to test the appliance before final finishing may require significant and costly reconstruction

## INSTALLATION PRECAUTIONS:

Consult local building codes before beginning the installation. The installer must make sure to select the proper vent system for installation. Before installing the vent kit, the installer must read this fireplace manual and vent kit instructions. Only a qualified, licensed, installer/service person shall install the venting system. The installer must follow the following safety rules:

- Wear gloves and safety glasses for protection.
- Use extreme caution when using ladders or when on rooftops.
- Be aware of electrical wiring locations in walls and ceilings.

The following actions will void the warranty on your fireplace:

- Installation of any damaged venting component.
- Unauthorized modification of the venting system.
- Installation of any component part not manufactured or approved by SÓLAS Contemporary Fires.
- Installation other than permitted by these instructions.

## NOTICE

Failure to follow these instructions will void the warranty.

# INSTALLATION INFORMATION

State of Massachusetts:

The installation must be completed by a licensed plumber or gas fitter in the Commonwealth of Massachusetts.

## REQUIREMENTS FOR THE COMMONWEALTH OF MASSACHUSETTS

This product must be installed by a licensed plumber or gas fitter when installed within the Commonwealth of Massachusetts. If this appliance is installed in a dwelling, building or structure used in whole or in part for residential purposes and the installation includes a horizontal vent termination that is less than seven (7) feet above the finished grade in the area of the venting, including but not limited to decks and porches, a hard-wired carbon monoxide detector with an alarm and battery back-up must be installed on the floor level of the dwelling, building or structure where the appliance is to be installed.

Additionally, a hard-wired or battery operated carbon monoxide detector with an alarm must be installed on each additional level of the dwelling, building or structure served by the appliance. It shall be the responsibility of the property owner to secure the services of qualified licensed professionals for the installation of hard-wired carbon monoxide detectors.

In the event that the horizontally vented appliance is installed in a crawl space or attic, the hard-wired carbon monoxide detector with alarm and battery back-up may be installed on the next adjacent floor level.

In the event that this requirement cannot be met at the time of completion of the installation of the appliance, the owner shall have a period of thirty (30) days to comply with the requirement. However, during said thirty (30) day period, a battery operated carbon monoxide detector with alarm must be installed.

Each carbon monoxide detector as required in accordance with the above provisions must comply with NFPA 720 and be ANSI/UL 2034 and IAS certified.

In addition, when the vent termination is less than seven (7) feet above finished grade a metal or plastic identification plate must be permanently mounted to the exterior of the building at a minimum height of eight (8) feet above grade directly in line with the exhaust vent terminal. The sign shall read, in print size no less than one-half (1/2) inch in size, "GAS VENT DIRECTLY BELOW. KEEP CLEAR OF ALL OBSTRUCTIONS".

A COPY OF THESE INSTRUCTIONS PLUS ALL VENTING INSTRUCTIONS WHICH INCLUDE PARTS LISTS, AND/OR ALL VENTING DESIGN INSTRUCTIONS MUST REMAIN WITH THE STOVE AT THE COMPLETION OF THE INSTALLATION.

ATTENTION INSTALLERS: Mark below which venting system was used in the installation. These instructions must remain with the SÓLAS Gas Fireplace Installation & Operation Manual.

Simpson DuraVent GS/PRO®

Selkirk Direct-Temp®

Security Secure Vent™

AmeriVent Direct™

Metal Fab Direct Vent

ICC Direct Vent

# VENTING

## WARNING

This fireplace must be vented to the outside. The venting system must NEVER be attached to a chimney serving a separate solid fuel burning appliance. Each gas appliance must use a separate vent system. Do not use common vent systems.

## INSTALLATION PLANNING

The SÓLAS FORTY<sup>8</sup>, SIXTY<sup>0</sup>, and SEVENTY<sup>2</sup> use 4x6 Direct-vent pipe.

There are two basic types of direct-vent installation:

- Horizontal Termination
- Vertical Termination

It is important to select the proper length of vent pipe for the type of termination you choose, taking into consideration wall thicknesses.

## FOR HORIZONTAL TERMINATION

Select the amount of vertical rise desired. All horizontal run of venting must have ¼" rise for every 12" of horizontal run.

## WARNING

Never run the vent pipe level or downward. This may cause excessive temperatures which could cause a fire.

## FOR VERTICAL TERMINATION

Measure the distance from the Horizontal Vent Center Line (see diagram on page 8). Add the ceiling thickness, the vertical rise in an attic or second story, and allow for sufficient vent height above the roofline.

## NOTE:

You may use two 45° elbows in place of a 90° elbow. You must follow rise to run ratios when using 45° elbows. The appliance is approved for use with three 90° elbows maximum of a combination of 90° and 45° elbows up to a maximum of 270°.

For two-story applications, firestops are required at each floor level. If an offset is needed in the attic, additional pipe and elbows will be required.

It is very important that the venting system maintain its balance between the combustion air intake and the flue gas exhaust. Certain limitations apply to vent configurations and must be strictly followed.

## INSTALLING A VENT SYSTEM IN AN OUTSIDE CHASE

A chase is a vertical box like structure built to enclose venting that runs along the outside of a building. A chase is required for such venting.

## NOTICE

Treatment of firestops and construction of the chase may vary from building type to building type. These instructions are not substitutes for local building code requirements.

## NOTICE

When installing in a chase, you should insulate the chase as you would the outside walls of your home. This is especially important in cold climates. Insulation should be considered a combustible material. Maintain proper clearances to combustibles.



# VENTING

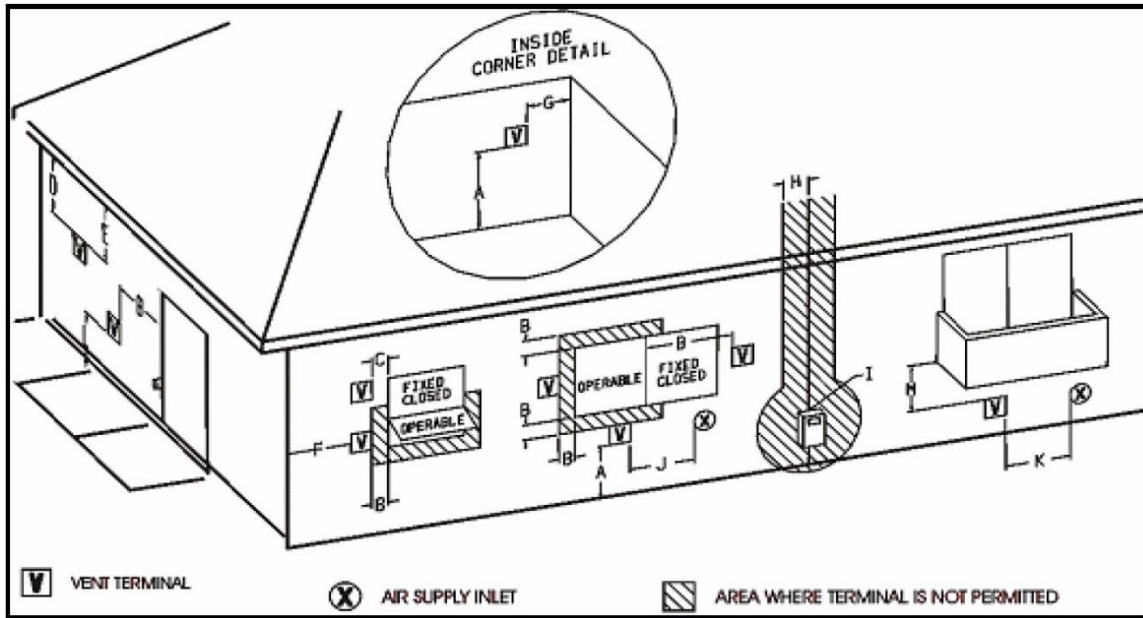

	Canadian Installations <sup>1</sup>	U.S. Installations <sup>2</sup>
A = Clearance above grade, veranda, porch, deck or balcony	12 inches (30 cm)	12 inches (30 cm)
B = Clearance to window or door that may be opened	12 inches (30 cm)	9 inches (23 cm)
C = Clearance to a permanently closed window	See Footnotes 5 & 6	See Footnote 5
D = Vertical clearance to a ventilated soffit located above the terminal within a horizontal distance of 2 feet (61 cm) from the centerline of the terminal	See Footnotes 5 & 6	See Footnote 5
E = Clearance to unventilated soffit	See Footnotes 5 & 6	See Footnote 5
F = Clearance to outside corner	See Footnotes 5 & 6	See Footnote 5
G = Clearance to inside corner	See Footnotes 5 & 6	See Footnote 5
H = Clearance to each side of centerline extended above meter/regulator assembly	3 feet (91 cm) within a height of 15 feet (4.5 m) above the regulator/meter assembly	See Footnote 5
I = Clearance to service regulator vent outlet	3 feet (91 cm)	See Footnote 5
J = Clearance to non-mechanical air supply inlet to building or the combustion air inlet to any other appliance	12 inches (30 cm)	9 inches (23 cm)
K = Clearance to a mechanical air supply inlet	6 feet (1.83 m)	3 feet (91 cm) above if within 10 feet (3 m) horizontally
L = Clearance above paved sidewalk or paved driveway located on public property	7 feet (2.12 m)	See Footnote 5
M = Clearance under veranda, porch, deck or balcony	12 inches (30 cm) See Footnote 4	See Footnote 5

## Footnotes

- <sup>1</sup> In accordance with the current CSA B419.1, Natural Gas and Propane Installation Code
- <sup>2</sup> In accordance with the current ANSI Z223.1 / NFPA 54, National Fuel Gas Code
- A vent shall not terminate directly above a sidewalk or paved driveway that is located between two single family dwellings and serves both dwellings.
- Permitted only if veranda, porch, deck or balcony is fully open on a minimum of two sides below the floor.
- Clearance in accordance with local installation codes and the requirements of the gas supplier.
- Dégagement conforme aux codes d'installation locaux et aux exigences du fournisseur de gaz.

Install a Simpson Duravent (Or equivalent) wall thimble, part number 46DVA-WT (not supplied by SÓLAS), where the pipe passes through a wall to retain any insulation in the wall and to maintain proper clearances. If the wall being penetrated is constructed of non-combustible material only (i.e., Masonry block or concrete), the wall thimble is not required; and a hole with zero clearance is acceptable (6 5/8" hole).

## NOTICE:

Venting terminals shall not be recessed into a wall or siding.

# VENTING

This SÓLAS Gas Fireplace has been tested and listed for installation with 4" X 6 5/8" M&G DuraVent GS/Pro®, Selkirk Direct-Temp®, Security Secure Vent™, AmeriVent Direct™, Metal Fab Direct Vent and ICC EXCELDirect venting components. Although you may use the pipe components (straight pipe, elbows, etc.) from any of the listed manufacturers, you may only use the vent terminations (caps) listed in the chart on the following page. For installations where a snorkel is needed, please note that only three snorkels are approved for use. Please plan your installation accordingly.

For all specific venting installation requirements, follow the installation instructions included by the venting manufacturer with the venting system components you have chosen.

## PLEASE NOTE:

- It is assumed that the installation will include at least one 90° elbow. Up to three additional 90° elbows (or equivalent 45° elbows) may also be used. The total venting may not exceed 20 feet of vertical rise and/or 10 feet horizontal run. Refer to the venting charts on pages 16 for specific details while you plan your installation. Note: The number of elbows impacts the maximum allowable horizontal vent run.
- There should be a 1 1/2" overlap of the vent and combustion air tubes, when telescopic joints are used.
- The location of the vent termination must meet the requirements of the current edition of ANSI Z223.1/NFPA 54, National Fuel Gas Code or CAN B419.1, Natural Gas and Propane Installation Code and the requirements shown on page 14 of this manual.

APPROVED VENT TERMINATIONS	M&G DURAVENT GS/PRO	SELKIRK DIRECT-TEMP	SECURITY SECURE VENT	AMP AMERIVENT DIRECT	METAL FAB DIRECT VENT	ICC EXCELDIRECT
<b>VERTICAL CAP</b>	46DVAVCH	1604802	SV4CGC	4DVC	4DVT	TM4VT
<b>HORIZONTAL CAP</b>	46DVAHC 46DVAHRCS 46DVAHSC	1604804	SV4GHC	4DVHC	4DHT	TM4HT TM4DHT
<b>SNORKEL</b>	N/A	1604836	N/A	4D36C	N/A	TMST36

Just as with any other vented device, vertical vent rise creates draft (negative pressure) in the firebox as the exhaust gases heat up. If this draft becomes excessive, it can affect the performance or appearance of the fire. The SÓLAS Gas Fireplace includes an integrated air restrictor that can be used to balance the draft in the fireplace to the optimal level for installations where excessive draft might occur. The SÓLAS Gas Fireplace will ship from the factory with the air restrictor set to the #1 position. If the licensed fireplace installer determines that draft reduction is necessary, loosen the fastener on the dial and make small adjustments from #1 to #4 until a satisfactory result has been achieved.

The air restrictor dial is located on the flue side of the firebox when viewed from the front. To access, remove the lower air screen and side panels. Once satisfied with the air restrictor adjustment, secure its position by tightening all hardware.



# VENTING

## SÓLAS flue restrictor kit, part #11317

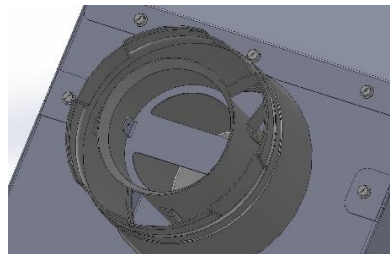
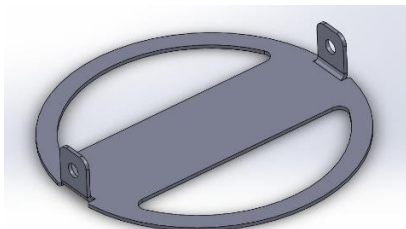

Some vent configurations may create excess draft within the fireplace. Excess draft can cause issues such as a rapid, or “nervous” flame picture, undesirable flame color, or pilot lifting which may prevent the fireplace from staying lit. In these circumstances it may be necessary to install the flue restrictor kit part #11317 in the venting system. It is permissible to install this restrictor at the vent cap should the venting system already be installed. Secure the restrictor plate with the included #10 sheet metal screws.

## SÓLAS FORTY8 flue baffle kit, part #11273

Certain vent configurations for the SÓLAS FORTY8, particularly those with a significant amount or vertical in relation to the amount of horizontal vent pipe, may cause the flame to be unbalanced, or biased toward the flue outlet side of the fireplace. Installation of this flue baffle, part #11273, will help to resolve this issue. It may be necessary to use this restrictor on its own, or in addition to the SÓLAS flue restrictor kit, part #11317 shown above. This flue baffle kit snaps into the fireplace as shown below.

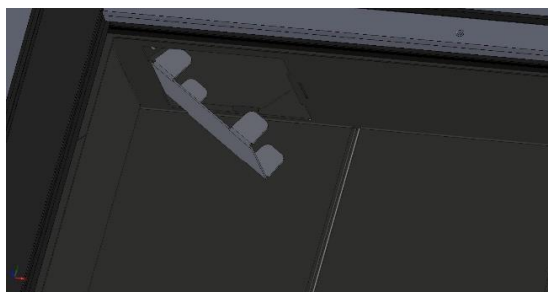
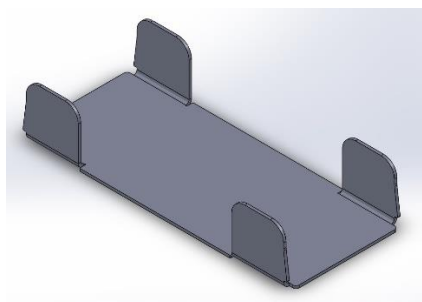
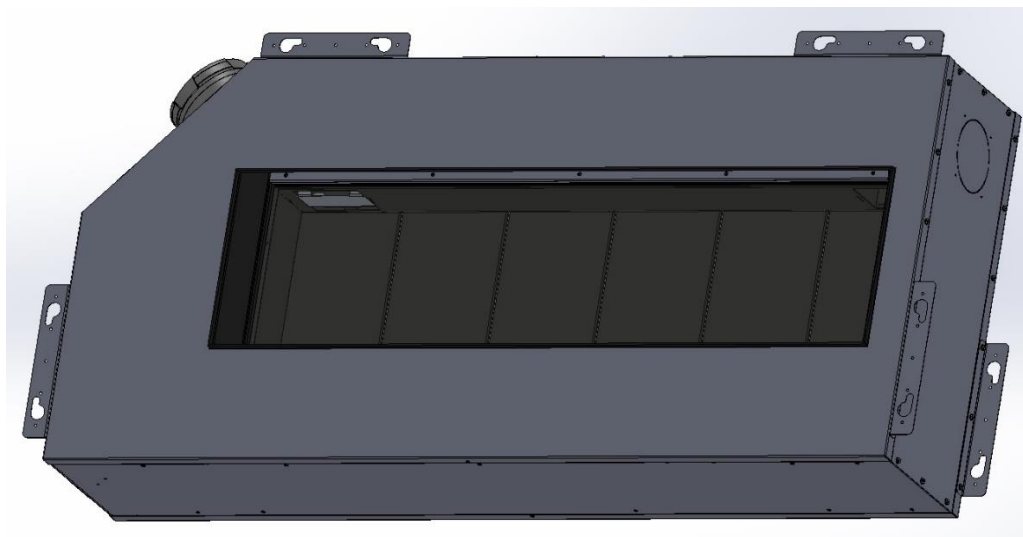

# VENTING

Use this worksheet to determine the equivalent horizontal run for use with the vent charts on the next page. The information contained within this worksheet may also be useful during installation or in the event that you need technical assistance from SÓLAS.

- A. FUEL TYPE                       NATURAL GAS                       LP GAS (PROPANE)
- B. TOTAL VERTICAL VENT RISE (MEASURED FROM HORIZONTAL CENTERLINE OF VENT OPENING ON THE BACK OF THE FIREPLACE TO THE HORIZONTAL CENTERLINE OF THE VENT CAP (FOR HORIZONTAL VENT CAPS) OR TO THE FLANGE ON THE CAP (FOR VERTICAL CAPS): \_\_\_\_\_ FEET
- C. TOTAL HORIZONTAL VENT RUN (MEASURED FROM THE VENT STARTER ON THE FIREPLACE TO THE FLANGE ON THE CAP (FOR HORIZONTAL CAPS) OR TO THE VERTICAL CENTERLINE OF THE CAP (FOR VERTICAL CAPS)): \_\_\_\_\_ FEET

NOTE: THE VERTICAL VENT RISE AND HORIZONTAL VENT RUN ARE THE OFFSETS IN THE LOCATIONS OF VENT CAP RELATIVE TO THE VENT OPENING ON THE FIREPLACE. VENT PIPE THAT RUNS AT 45° HAVE BOTH A VERTICAL RISE AND HORIZONTAL RUN. SNORKEL CAPS HAVE BUILT-IN VERTICAL RISE THAT MUST BE COUNTED.

- D. TOTAL NUMBER OF 90° ELBOWS: \_\_\_\_\_ NOTE: SNORKELS COUNT AS 2- 90° ELBOWS
- E. TOTAL NUMBER OF 45° ELBOWS: \_\_\_\_\_

HORIZONTAL VENT RUN EQUIVALENT CALCULATOR

- C. Total horizontal vent run (actual): \_\_\_\_\_
- D. 90° Elbows needed: \_\_\_\_\_
- E. 45° Elbows needed: \_\_\_\_\_
- F. Total 90° Elbows equivalent:                       $D+(E \times \frac{1}{2})$                       = \_\_\_\_\_
- G. 90° Elbows in excess or 2:                       $F-2$                       = \_\_\_\_\_
- H. Additional horiz. feet (equivalent):                       $G \times 3$                       = \_\_\_\_\_
- I. Horizontal vent run (equivalent):                       $C+H$                       = \_\_\_\_\_

TERMINATION (CAP) TYPE:  HORIZONTAL                       VERTICAL                       SNORKEL

VENT BRAND:

- Simpson DuraVent GS/PRO®                       Selkirk Direct-Temp®                       Security Secure Vent™
- AmeriVent Direct™                       Metal Fab Direct Vent                       ICC Direct Vent

VENT CAP MODEL NO: \_\_\_\_\_ NOTE: SEE APPROVED VENT CAPS ON THE PREVIOUS PAGE.

WAS THE FIREPLACE INSTALLED WITH A SÓLAS POWER VENT? (CIRCLE ONE)    Y    N

# VENTING

Vent chart for SÓLAS FORTY8.

VERTICAL VENT RUN (FT)	30	GV	GV	GV	GV	GV	GV	GV	GV	GV	GV	GV	GV	PV	PV	PV	
	29	GV	GV	GV	GV	GV	GV	GV	GV	GV	GV	GV	GV	PV	PV	PV	
	28	GV	GV	GV	GV	GV	GV	GV	GV	GV	GV	GV	GV	PV	PV	PV	
	27	GV	GV	GV	GV	GV	GV	GV	GV	GV	GV	GV	GV	PV	PV	PV	
	26	GV	GV	GV	GV	GV	GV	GV	GV	GV	GV	GV	GV	PV	PV	PV	
	25	GV	GV	GV	GV	GV	GV	GV	GV	GV	GV	GV	GV	PV	PV	PV	
	24	GV	GV	GV	GV	GV	GV	GV	GV	GV	GV	GV	GV	PV	PV	PV	
	23	GV	GV	GV	GV	GV	GV	GV	GV	GV	GV	GV	GV	PV	PV	PV	
	22	GV	GV	GV	GV	GV	GV	GV	GV	GV	GV	GV	GV	PV	PV	PV	
	21	GV	GV	GV	GV	GV	GV	GV	GV	GV	GV	GV	GV	PV	PV	PV	
	20	GV	GV	GV	GV	GV	GV	GV	GV	GV	GV	GV	GV	PV	PV	PV	
	19	GV	GV	GV	GV	GV	GV	GV	GV	GV	GV	GV	GV	PV	PV	PV	
	18	GV	GV	GV	GV	GV	GV	GV	GV	GV	GV	GV	GV	PV	PV	PV	
	17	GV	GV	GV	GV	GV	GV	GV	GV	GV	GV	GV	GV	PV	PV	PV	
	16	GV	GV	GV	GV	GV	GV	GV	GV	GV	GV	GV	GV	PV	PV	PV	
	15	GV	GV	GV	GV	GV	GV	GV	GV	GV	GV	GV	GV	PV	PV	PV	
	14	GV	GV	GV	GV	GV	GV	GV	GV	GV	GV	GV	GV	PV	PV	PV	
	13	GV	GV	GV	GV	GV	GV	GV	GV	GV	GV	GV	GV	PV	PV	PV	
	12	GV	GV	GV	GV	GV	GV	GV	GV	GV	GV	GV	GV	PV	PV	PV	
	11	GV	GV	GV	GV	GV	GV	GV	GV	GV	GV	GV	GV	PV	PV	PV	
	10	GV	GV	GV	GV	GV	GV	GV	GV	GV	GV	GV	GV	PV	PV	PV	
	9	GV	GV	GV	GV	GV	GV	GV	GV	GV	GV	GV	GV	PV	PV	PV	
	8	GV	GV	GV	GV	GV	GV	GV	GV	GV	GV	GV	GV	PV	PV	PV	
	7	GV	GV	GV	GV	GV	GV	GV	GV	GV	GV	GV	GV	PV	PV	PV	
	6	GV	GV	GV	GV	GV	GV	GV	GV	GV	GV	GV	GV	PV	PV	PV	
	5	GV	GV	GV	GV	GV	GV	GV	GV	GV	GV	GV	GV	PV	PV	PV	
	4	GV	GV	GV	GV	GV	GV	GV	GV	GV	GV	GV	GV	PV	PV	PV	
	3	GV	GV	GV	GV	GV	GV	GV	GV	GV	GV	GV	GV	PV	PV	PV	
	2	GV	GV	GV	GV	GV	GV	GV	GV	GV	GV	GV	GV	PV	PV	PV	
	1	GV	GV	GV	GV	GV	GV	GV	GV	GV	GV	GV	GV	PV	PV	PV	
	0	NA	PV	PV	PV	PV	PV	PV	PV	PV	PV	PV	PV	PV	PV	PV	
		0	1	2	3	4	5	6	7	8	9	10	11	12	13	14	15

HORIZONTAL VENT RUN (Ft)

NA = NOT ALLOWED     
 GV = GRAVITY VENT     
 PV = POWER VENT

Vent chart for SÓLAS SIXTY0 and SEVENTY2.

VERTICAL VENT RUN (FT)	30	GV	GV	GV	GV	GV	GV	GV	GV	GV	GV	GV	GV	PV	PV	PV	
	29	GV	GV	GV	GV	GV	GV	GV	GV	GV	GV	GV	GV	PV	PV	PV	
	28	GV	GV	GV	GV	GV	GV	GV	GV	GV	GV	GV	GV	PV	PV	PV	
	27	GV	GV	GV	GV	GV	GV	GV	GV	GV	GV	GV	GV	PV	PV	PV	
	26	GV	GV	GV	GV	GV	GV	GV	GV	GV	GV	GV	GV	PV	PV	PV	
	25	GV	GV	GV	GV	GV	GV	GV	GV	GV	GV	GV	GV	PV	PV	PV	
	24	GV	GV	GV	GV	GV	GV	GV	GV	GV	GV	GV	GV	PV	PV	PV	
	23	GV	GV	GV	GV	GV	GV	GV	GV	GV	GV	GV	GV	PV	PV	PV	
	22	GV	GV	GV	GV	GV	GV	GV	GV	GV	GV	GV	GV	PV	PV	PV	
	21	GV	GV	GV	GV	GV	GV	GV	GV	GV	GV	GV	GV	PV	PV	PV	
	20	GV	GV	GV	GV	GV	GV	GV	GV	GV	GV	GV	GV	PV	PV	PV	
	19	GV	GV	GV	GV	GV	GV	GV	GV	GV	GV	GV	GV	PV	PV	PV	
	18	GV	GV	GV	GV	GV	GV	GV	GV	GV	GV	GV	GV	PV	PV	PV	
	17	GV	GV	GV	GV	GV	GV	GV	GV	GV	GV	GV	GV	PV	PV	PV	
	16	GV	GV	GV	GV	GV	GV	GV	GV	GV	GV	GV	GV	PV	PV	PV	
	15	GV	GV	GV	GV	GV	GV	GV	GV	GV	GV	GV	GV	PV	PV	PV	
	14	GV	GV	GV	GV	GV	GV	GV	GV	GV	GV	GV	GV	PV	PV	PV	
	13	GV	GV	GV	GV	GV	GV	GV	GV	GV	GV	GV	GV	PV	PV	PV	
	12	GV	GV	GV	GV	GV	GV	GV	GV	GV	GV	GV	GV	PV	PV	PV	
	11	GV	GV	GV	GV	GV	GV	GV	GV	GV	GV	GV	GV	PV	PV	PV	
	10	GV	GV	GV	GV	GV	GV	GV	GV	GV	GV	GV	GV	PV	PV	PV	
	9	GV	GV	GV	GV	GV	GV	GV	GV	GV	GV	GV	GV	PV	PV	PV	
	8	GV	GV	GV	GV	GV	GV	GV	GV	GV	GV	GV	GV	PV	PV	PV	
	7	GV	GV	GV	GV	GV	GV	GV	GV	GV	GV	GV	GV	PV	PV	PV	
	6	GV	GV	GV	GV	GV	GV	GV	GV	GV	GV	GV	GV	PV	PV	PV	
	5	GV	GV	GV	GV	GV	GV	GV	GV	GV	GV	GV	GV	PV	PV	PV	
	4	GV	GV	GV	GV	GV	GV	GV	GV	GV	GV	GV	GV	PV	PV	PV	
	3	GV	GV	GV	GV	GV	GV	GV	GV	GV	GV	GV	GV	PV	PV	PV	
	2	GV	GV	GV	GV	GV	GV	GV	GV	GV	GV	GV	GV	PV	PV	PV	
	1	GV	PV	PV	PV	PV	PV	PV	PV	PV	PV	PV	PV	PV	PV	PV	
	0	NA	PV	PV	PV	PV	PV	PV	PV	PV	PV	PV	PV	PV	PV	PV	
		0	1	2	3	4	5	6	7	8	9	10	11	12	13	14	15

HORIZONTAL VENT RUN (Ft)

NA = NOT ALLOWED     
 GV = GRAVITY VENT     
 PV = POWER VENT

Power vent runs of up to 110ft with (6) 90° elbows are permitted when using the SOLAS power vent kit PV-486072. Refer to power vent instructions for additional power vent installation and operation information.

# FINAL ASSEMBLY

## SCREEN REMOVAL:

1. Lift up on the lower air panel to remove it from the fireplace opening.



2. Remove the left and right side panels by lifting up and toward you.



3. The fireplace screen is held in place by 3 self-tensioning latches along its top edge (4 latches on the SEVENTY2). Release these latches to remove the screen.

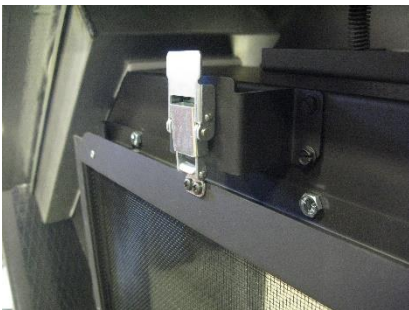

4. Allow the screen to rest in the fireplace opening, confirm that the latches are in their "home" position.

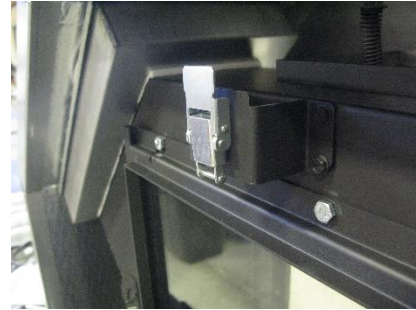

5. Lift the screen up so that the bottom of the screen clears the bottom of the fireplace opening.



6. Angle the screen toward you from the bottom to remove.

To reinstall the screen, reverse these steps. Remember to confirm the latches are in their "home" position any time you are installing or removing the screen.

### NOTICE

If this screen is removed for servicing this appliance it must be replaced prior to operating the appliance.

# FINAL ASSEMBLY

## FINAL ASSEMBLY GLASS REMOVAL:

1. With the screen removed, loosen the ¼-20 bolts along the top edge of the glass frame using a 7/16 socket.

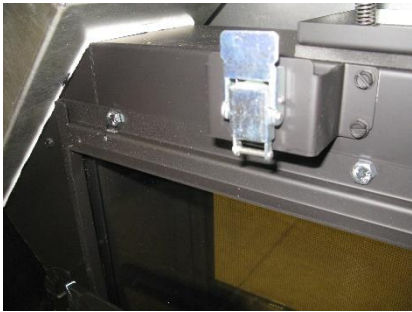

2. Confirm that the Screen latches are in their “home” position. (see image)
3. Lift the glass frame assembly up so that the bottom of the glass frame assembly clears the bottom of the fireplace opening.



### NOTICE

Do not attempt to operate the fireplace without the screen or glass frame assembly in place. Doing so could lead to injury, property damage, or loss of life.

4. Angle the glass assembly toward you from the bottom to remove.



Refer to the next page for instructions on burner media placement.

## GLASS INSTALLATION:

1. Insert the glass frame assembly into the fireplace by angling the top of the glass in and up into the fireplace.



2. Lift the glass frame assembly up so that the bottom of the glass frame assembly clears the bottom of the fireplace opening.
3. Slide the glass frame into the glass frame retainer along the bottom of the firebox opening.
4. Install the ¼-20 bolts along the top edge of the glass frame assembly and tighten using a 7/16 socket.

# FINAL ASSEMBLY

## PLACING THE BURNER GLASS MEDIA

The burner glass media poly-bag that you set aside when you unpacked the fireplace contains the correct amount of glass material to cover the burner. DO NOT add any additional media to the media supplied with your fireplace. The entire contents of the bag should be evenly distributed over the burner tray.

1. Locate the burner in the fireplace. Refer to the adjacent illustration.
5. Carefully clip one corner of the poly-bag to form a pouring spout. The opening should be large enough to allow the glass media to flow but not so large that you can't control the flow.
6. You will notice that the burner surface is designed with turned-up edges that form a tray to hold the glass media.
7. Starting at one end, pour the glass media onto the burner tray, keeping the pouring spout on the poly-bag toward the center of the burner to avoid spillage of glass pieces over the sides of the burner. See the adjacent illustrations.
8. Once you have poured all of the glass burner media into the burner tray, carefully smooth the glass pieces out so they have a uniform depth over the entire surface of the burner. When the burner glass media is properly placed, it should look like the adjacent illustrations.

Note: If a few pieces of glass escape over the edges of the burner tray during installation, it is not a problem. They will simply land in the area below the burner and will do no harm.

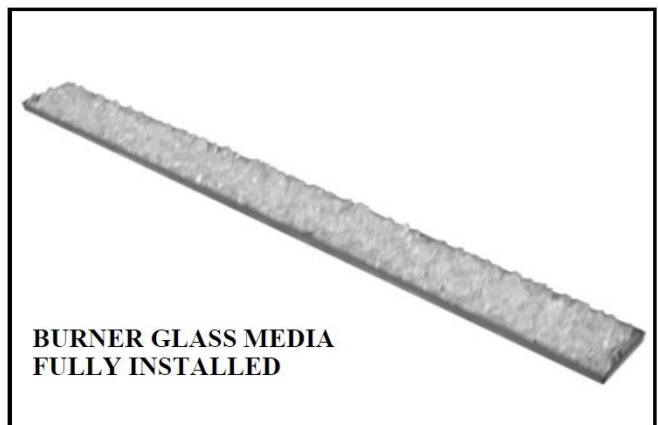
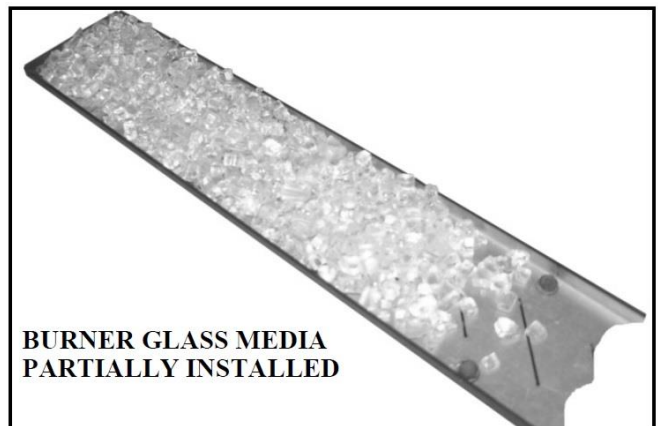
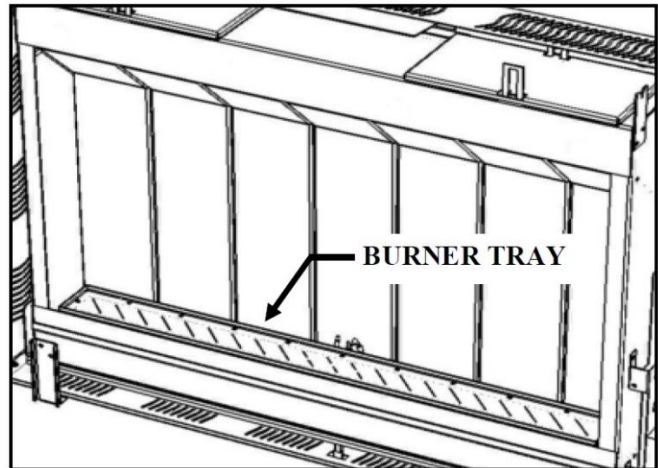



# LIGHTING & OPERATION

**WARNING: If you do not follow these instructions exactly, a fire or explosion may result causing property damage, personal injury or loss of life.**

When lighting this appliance, follow these instructions exactly.

- A. This appliance is equipped with an ignition device that automatically lights the pilot. Do not try to light the pilot by hand.
- B. BEFORE OPERATING THE BURNER SYSTEM, smell around the appliance area for gas. Be sure to smell next to the floor because some gas is heavier than air and will settle on the floor.

## WHAT TO DO IF YOU SMELL GAS

- Do not try to light the appliance.
  - Do not touch any electric switch; do not use any telephone in your building.
  - Immediately call your gas supplier from a neighbor's telephone. Follow the gas supplier's instructions
  - If you cannot reach your gas supplier, call the fire department.
- C. Use only your hand to operate the gas controls. Never use tools. If a knob will not push in or turn by hand, don't try to re-pair it, call a qualified service technician. Force or attempted repair may result in a fire or explosion.
- D. Do not use this appliance if any part has been under water. Immediately call a qualified service technician to inspect the appliance and to replace any part of the control system which has been under water.

## OPERATING INSTRUCTIONS

1. STOP! Read the safety information above on this label.
  9. This appliance is equipped with an ignition device that automatically lights the pilot. Do not try to light the pilot by hand.
  10. Using the Remote Handset, or the optional Wall Switch, push the "OFF" Ⓞ button until you hear an audible signal to insure the appliance is off.
  11. Wait five (5) minutes to clear out any gas. Then smell for gas including near the floor. If you smell gas, STOP! Follow "B" in the safety information above. If you don't smell gas, proceed to step 5.
  12. Using either the Remote Handset, or the optional Wall Switch, simultaneously press the "ON" Ⓞ and "High Flame" ↑ buttons. An audible signal confirms the start sequence has begun.
  13. Continuing beeps confirm the ignition is in process. Once lighting the pilot flame should appear as shown in Fig.2. Once the pilot is confirmed, the main burner ignites on high.
- NOTE: If the pilot does not stay lit after several tries, proceed to step 9.
14. Use the flame height adjustment buttons on either the Remote Handset or the optional Wall Switch to adjust the flame. Press the ↓ button twice to decrease the flame height to its lowest setting, press the ↑ button twice to increase flame height to the highest setting. Pressing the ↑ or ↓ button once will modulate the flame to intermediate settings. The Remote Handset can also be used to control the appliance thermostatically.
  15. Press and hold the ↓ button on the Remote Handset or optional Wall Switch to set the appliance to Pilot flame only.
  16. If the appliance will not operate, follow the instructions "TO TURN OFF GAS TO THE APPLIANCE" and call your gas service technician or gas supplier.

## TO TURN OFF GAS TO THE APPLIANCE

1. To turn off gas to the appliance, push and release the "OFF" Ⓞ button on either the Remote Handset or the optional Wall Switch. An audible signal will confirm.
17. TO TURN OFF THE GAS SUPPLY TO THE APPLIANCE, close the shut-off valve on the gas supply line to the appliance.

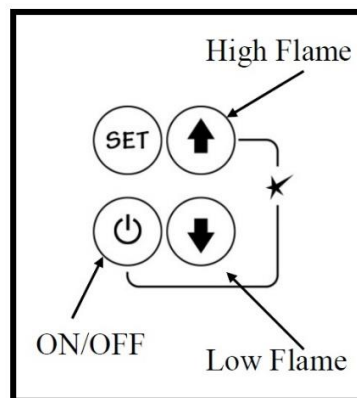

FIG. 1

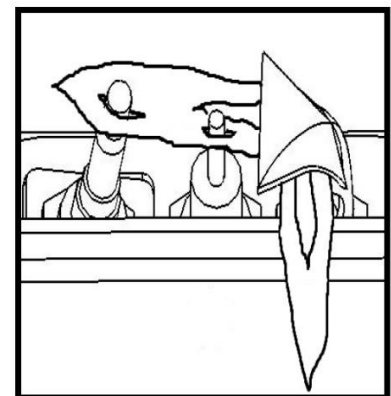

FIG. 2

# LIGHTING & OPERATION

## OPERATING YOUR FIREPLACE FOR THE FIRST TIME

When operating your new fireplace for the first time, some vapors may be released due to the curing compounds used in the manufacture of the appliance. They may cause a slight odor and could cause the flames to be the full height of the firebox, or even slightly higher, for the first few hours of operation. It is also possible that these vapors could set off and smoke detection alarms in the immediate vicinity. These vapors are quite normal on new appliances. We recommend opening a window to vent the room during the burn off period. After a few hours use, the vapors will have disappeared and the flames will be at their normal height.

## FLAME SUPERVISION DEVICE

For your safety, this appliance is fitted with a flame supervision device which will shut-off the gas supply if, for any reason, the pilot flame goes out. This device incorporates a fixed probe, which senses the heat from the pilot flame. If the probe is cool, the device will prevent any gas flow unless manually lighting the pilot. See full lighting instructions. Periodically check the pilot and burner flames, comparing them to figure 2 on the preceding page, and the image at the bottom of this page.

## LIGHTING, OPERATION, AND RATING INFORMATION

The Lighting, Operation and Rating information is located on a plate on the RH side of the firebox.



To access the plate, remove the surround and grab the plate and slide it up to read it. There is important information on both sides of the plate.

## SERVICING

If any attention is required for your appliance, contact your dealer quoting the model number. It will be helpful if the appliance's serial number can also be quoted. This number is on the rating plate, which is located under the burner. The replacement parts are shown at the end of this manual. Please always quote the part number and description when requesting spare parts.

## FIREPLACE CONTROL DEVICES

There are two ways to control your fireplace.

1. Thermostatic Remote Control (M46-507)
2. Optional Wall Switch (M46-505)

The Thermostatic Remote Control can be programmed to function automatically—see pages 26-31.

The Wall Switch (optional) can be used to turn the flame on, off, and to increase or decrease the flame height—see M46-505 —Wall Switch Kit.

**NOTE: The remote control in the AUTO mode will override the optional wall switch.**



Programmable Thermostatic Remote Control (M46-507)



Wall Switch (M46-505) (optional)







# REMOTE HANDSET OPERATION

## SÓLAS REMOTE HANDSET

Please note the images of the remote handset on pages 26-31 of this manual depict the Maxitrol GV60 Remote Control, although the profile of the remote depicted is different from the one included with your fireplace, the buttons and operation of the remote is the same.

Follow the instructions in the manual using these guidelines:

- The large flame button  as seen in the manual's images is equivalent to the up arrow on your remote 
- The small flame button  as seen in the manual is equivalent to the down arrow on your remote 



GV60 Remote Control shown in this Manual



GV60 Remote Control supplied with your fireplace

## SÓLAS REMOTE HANDSET PAIRING

- Press and hold the Reset button on the Receiver mounted within your fireplace. Initially you will hear a short beep, continue to hold the Reset button until you hear a second longer beep.
- Press the down arrow on your remote .
- You will hear 2 beeps from the Receiver confirming that your remote is now paired.



# REMOTE HANDSET OPERATION

## HOW TO TURN YOUR FIREPLACE OFF (INCLUDING PILOT)

Familiarize yourself with each of these methods before operating your fireplace.

**Handset and Wall Switch:** Press and hold the OFF button for a second (either on the handset or the wall switch).

If the flames are on, they go down and you hear the valve motor wind down. You hear a clunk and a beep indicating that the valve has received the signal from the remote control.

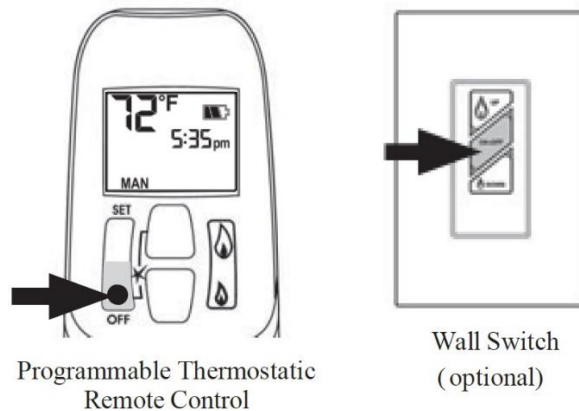

## HOW TO ENSURE YOUR FIREPLACE CANNOT BE TURNED ON INADVERTENTLY

You can use the following method to ensure that your fireplace will not turn on when you don't want it on.

First, ensure your fireplace is turned off—including the pilot—and cold BEFORE going ahead.

- Close the shut-off valve on the gas supply line to the appliance.
- Remove all batteries from the receiver as well as the battery from the handset.

### Automatic Shut-Off (in certain conditions)

Your fireplace's remote control is equipped with an automatic shut-off mechanism which is activated in certain conditions. See page 31 in the *Remote Control Operation* section for a description of this feature.

**NOTE:** Before using the remote control system for the first time, the receiver and the handset are synchronized at the factory. See the section *SOLAS Remote Handset Pairing Set-up* on page 25 of this manual if the receiver and handset lose synchronization.

**IMPORTANT:** BEFORE YOU BEGIN, please note that on this system, the settings of time, temperature and automatic ON/OFF can only be programmed when the function display is flashing. Be patient when programming as it can take a few seconds to set.

# REMOTE HANDSET OPERATION

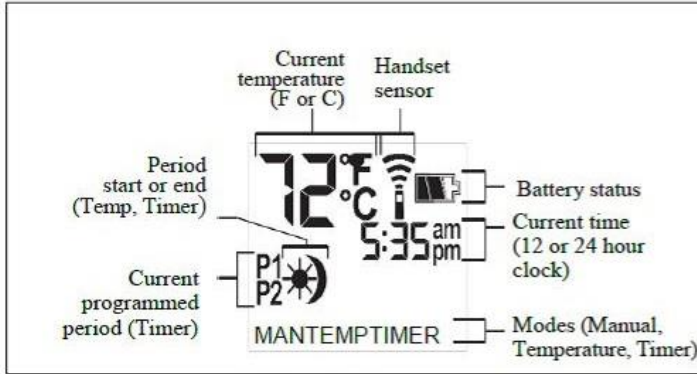

Display Overview

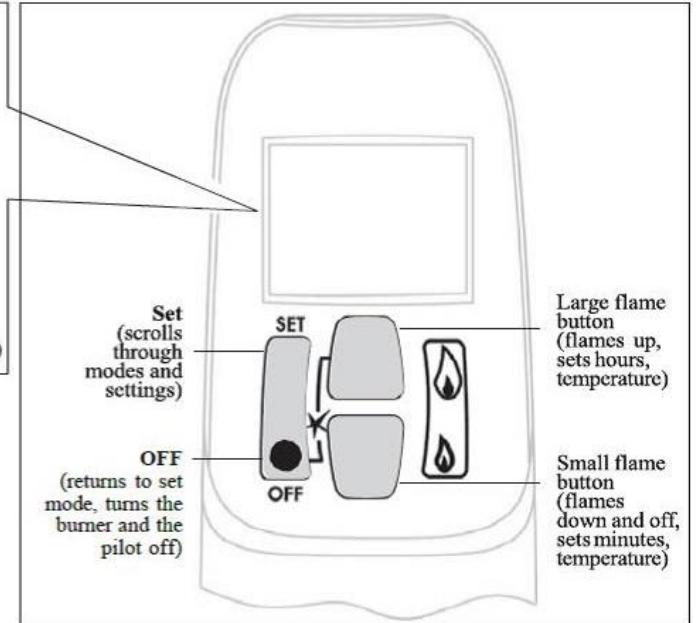

Handset Overview

Note: In the TEMP or TIMER modes, the remote handset senses the room temperature and adjusts the flame accordingly.

To communicate, the handset should be within 15 feet (4.5 meters) of the fireplace.

**Do not leave the handset on the hearth, mantel, or on top of the fireplace.**

## TO TURN ON APPLIANCE

### CAUTION

When pilot ignition is confirmed, motor turns automatically to maximum flame height.

- On the valve, turn MAN knob on the ON, full counterclockwise  position.

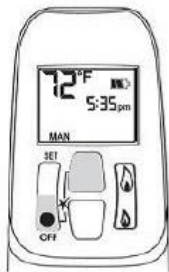

- Simultaneously press the OFF and 🔥 (large flame) buttons until a short beep confirms the start sequence has begun; release buttons.
- Continuing beeps confirm the ignition is in process.
- Once pilot ignition is confirmed, there is main gas flow.
- After main burner ignition the handset will automatically go into manual (MAN) control mode.

## TO TURN OFF APPLIANCE



- Press OFF button.

When the pilot is off, it will take 2 minutes before it can be lit again.

## STANDBY MODE (Pilot Flame)

- Press and hold 🔥 (small flame) to set appliance at pilot flame

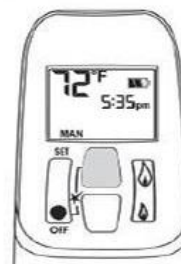

## FLAME HEIGHT ADJUSTMENT

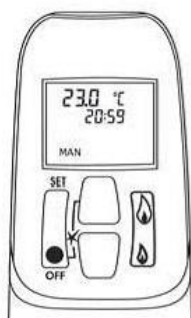

- In standby mode: Press and hold 🔥 (large flame) button to increase flame height.

# REMOTE HANDSET OPERATION



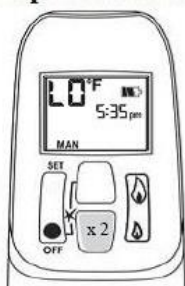

- Press and hold  (small flame) button to decrease flame height or to set the appliance at pilot flame.
- For fine adjustment tap the  (large flame) or  (small flame) buttons.

## Express Low and High Fire



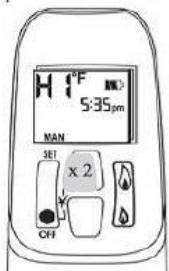

- Double-click  (small flame) button. “LO” will be displayed. NOTE: Flame goes to high fire first before going to designated low fire.



- Double-click  (large flame) button. Flame automatically goes to high fire. “HI” will be displayed.

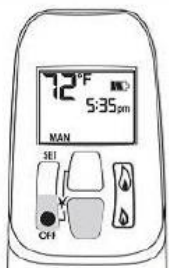

## SETTING °C/24-HOUR OR °F/12-HOUR

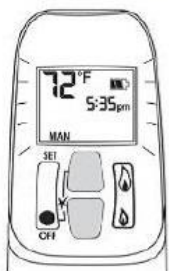

- In MAN mode, press OFF
- and  (small flame) buttons until display changes from Fahrenheit/12-hour clock to Celsius/24-hour clock and vice versa.

## SETTING THE TIME



- The time display will flash after either:
  - » Installing the battery or
  - » Simultaneously pressing the  (large flame) and  (small flame) buttons
- Press  (large flame) button to set the hour.

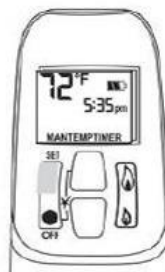

- Press  (small flame) button to set the minute.
- Press OFF or simply wait to return to MAN mode.

## MODES OF OPERATION

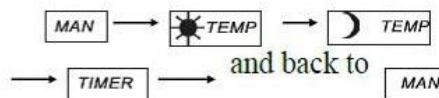

- Briefly pressing the SET button changes the mode of operation in the following order:



NOTE: Manual mode can also be reached by pressing either the  (large flame) or the  (small flame) buttons.



-  - **Manual Mode** - Manual Flame Height Adjustment.

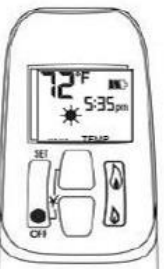

-  - **Daytime Temperature Mode** (Appliance must be in standby mode; pilot ignited) - The room temperature is measured and compared to the set temperature. The flame height is then automatically adjusted to achieve the Daytime Set Temperature.

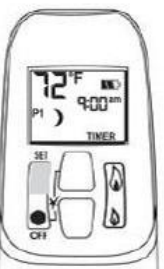

-  - **Daytime Temperature Mode** (Appliance must be in standby mode; pilot ignited) - The room temperature is measured and compared to the set temperature. The flame height is then automatically adjusted to achieve the Daytime Set Temperature.



-  - **Timer Mode** (Appliance must be in standby mode; pilot ignited) - The timers P1 and P2 (Program 1, Program 2) each can be programmed to go ON and OFF at specific times. For instructions see Timer Programming Mode.

NOTE: The display shows the set temperature every 30 seconds.

# REMOTE HANDSET OPERATION

## SETTING THE ON / OFF TEMPERATURES

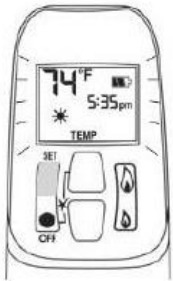

### SETTING THE “DAYTIME” TEMPERATURE

Default Settings:  TEMP (sun), 23°C / 74°F





- Briefly press SET button to scroll to TEMP  TEMP (sun) mode. Hold the SET button until the TEMP flashes.

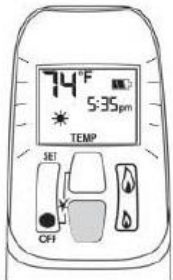

- Press  (large flame) button to increase the  ytime Set Temperature.



- Press  (small flame) button to decrease  Daytime Set Temperature.

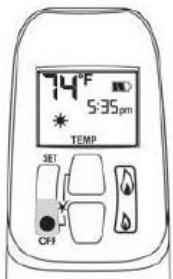

- Press OFF or simply wait to complete programming.



### SETTING THE “NIGHTTIME SETBACK” TEMPERATURE

Default Settings:  TEMP (moon), “- -” (OFF)





- Briefly press SET button to scroll to TEMP  TEMP (moon) mode. Hold the SET button until the TEMP flashes.

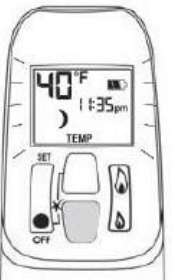

- Press  (large flame) button to increase  Nighttime Setback Temperature.



- Press  (small flame) button to decrease  Nighttime Setback Temperature.

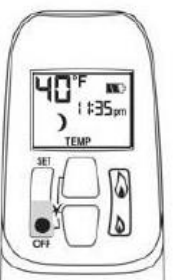

- Press OFF or simply wait to complete programming.

#### Tip

Set the different parameters when they are flashing.

# REMOTE HANDSET OPERATION

## SETTING PROGRAM TIMERS

- You can program two periods of time between 12:00 am and 11:50 pm in each 24-hour cycle.
- The Programs P1 and P2 must be set in the following order during a 24-hour cycle: P1 ☾, P1 ☀, P2 ☀ and P2 ☾.
- The icon ☀ indicates the beginning of the period (ON) and the icon ☾ indicates the end of the period (OFF).
- If P1 ☀ = P1 ☾, P2 ☀ = P2 ☾ the programming is cancelled.
- To keep the fireplace ON all night, set P2 ☾ at 11:50 am and P1 ☀ at 12:00 am.

### Default settings:

Program 1: P1 ☀ 6:00 am P1 ☾ 8:00 am  
 Program 2: P2 ☀ 11:50 pm P2 ☾ 11:50 pm

- Briefly press SET button to scroll to TIMER mode.

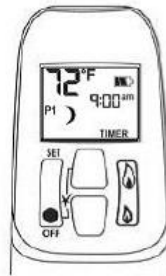

### SETTING P1 ON TIME

- Hold the SET button until P1 ☀ (sun) is displayed and the time flashes.

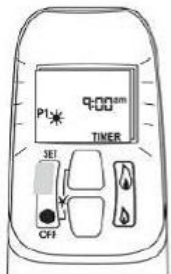

- Press ☾ (large flame) button to set the hour.

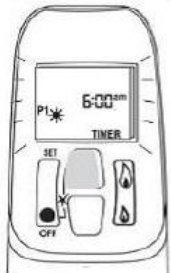

- Press ☀ (small flame) button to set the minutes.

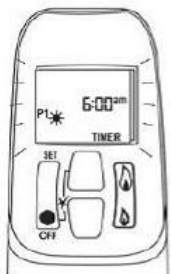

## SETTING P1 OFF TIME

- Briefly press SET button or scroll to TIMER P1 ☾ (moon) while the time flashes.

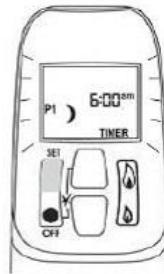

- Press ☾ (large flame) button to set the hour.

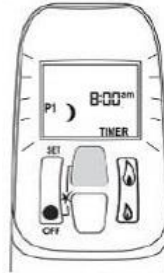

- Press ☀ (small flame) button to set the minutes.

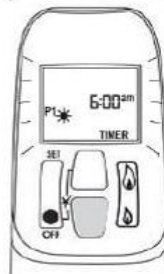

## SETTING P2 ON TIME

- Briefly press SET to scroll to TIMER mode P2 ☀ (sun) while the time flashes.
- Follow the instructions given to set P1 ON time.

## SETTING P2 OFF TIME

- Briefly press SET to scroll to TIMER mode P2 ☾ (moon) while the time flashes.
- Follow the instructions given to set P1 OFF time.

Press OFF button to save these settings. The timers are programmed. See the diagram on programming sequences on the following page.

### Tip

If you want to program only one period, program P1 ☀ and P1 ☾ with desired times and program P2 ☾ and P2 ☀ with the same time as P1 ☀.



# REMOTE HANDSET OPERATION

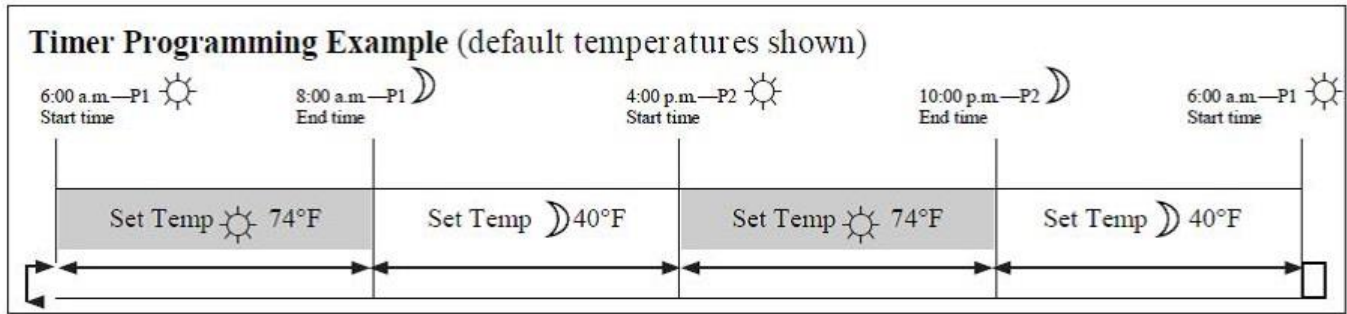

## AUTOMATIC TURN DOWN

- **No communication.** If there is no communication between the receiver and the handset for a period of 6 hours, the appliance goes into pilot mode.
- **No change in flame height.** If there is no change in flame height for a period of 6 hours, the appliance goes into pilot mode.

**NOTE:** In **TEMP** or **TIMER** modes, the flame height will vary according to room temperature. The appliance will continue to work normally. However, if the room temperature remains the same for 6 hours, the appliance will go into pilot mode.

## AUTOMATIC SHUT OFF

- **Low batteries in the receiver.** With low battery power in the receiver the system shuts off completely.

**NOTE:** This does not apply when the power supply is interrupted.

**No change in pilot.** The appliance shuts off completely when it is continually in pilot position—without any change—for a period of 5 days.

## LOW BATTERY INDICATION

### CAUTION

**DO NOT USE** a screwdriver or other metallic object to remove the batteries from the battery box or the handset! This could cause a short circuit.

**Remote handset:** The battery icon  will show when the battery needs to be replaced. Replace with one 3 “AAA” **alkaline** batteries.

**Receiver:** Three short ‘beeps’ will sound when the motor turns when the batteries need to be replaced. Replace with four 1.5 V **alkaline** batteries.

## HANDSET / RECEIVER MATCH

The remote control handset and receiver are programmed to function together. In case of a replacement of the handset or the receiver, you will need to reset the receiver to allow them to function together. Contact your dealer for details.

# GAS CONVERSION

These appliances are field convertible between Propane to Natural gas when a SÓLAS gas conversion kit is used. Gas conversions must be performed by a qualified service technician.

PART #	DESCRIPTION	SÓLAS CONVERSION KIT CONTENTS			
48BI-LPC	FORTY8 LP CONVERSION KIT	#27 PILOT ORIFICE	#49 LP BURNER ORIFICE – 1PC	#8 SCREW – 1PC	
48BI-NGC	FORTY8 NG CONVERSION KIT	#35 PILOT ORIFICE	#42 NG BURNER ORIFICE – 1PC	NG COLLAR – 1PC	#8 SCREW – 1PC
60BI-LPC	SIXTY0 LP CONVERSION KIT	#27 PILOT ORIFICE	#56 LP BURNER ORIFICE – 2PCS		#8 SCREW – 2PCS
60BI-NGC	SIXTY0 NG CONVERSION KIT	#35 PILOT ORIFICE	#49 NG BURNER ORIFICE – 2PCS	NG COLLAR – 2PCS	#8 SCREW – 2PCS
72BI-LPC	SEVENTY2 LP CONVERSION KIT	#27 PILOT ORIFICE	#55 LP BURNER ORIFICE – 2PCS		#8 SCREW – 2PCS
72BI-NGC	SEVENTY2 NG CONVERSION KIT	#35 PILOT ORIFICE	#46 NG BURNER ORIFICE – 2PCS	NG COLLAR – 2PCS	#8 SCREW – 2PCS

Before servicing the appliance, shut off gas and electrical power to the unit. To access the burner(s), follow the screen and glass removal procedure shown on pages 20 and 21.

1. The burner(s) are retained by #10 sheet metal screws, using a 5/16” nut driver, remove these screws. (8 screws in the FORTY8 and SIXTY0; 12 screws in the SEVENTY2).
2. The SIXTY0 and SEVENTY2 have a burner link that aligns the burners, remove the (2) #10 sheet metal screws.
3. Lift off the pilot hood.
4. The Pilot assembly is retained by (2) #10 sheet metal screws.
5. After removing the screws retaining the pilot assembly, lift the pilot assembly into the firebox.
6. Using a 10mm wrench, remove the pilot gas line to swap the orifice.
7. Once the pilot gas line is tight, reinstall the pilot assembly making sure the gasket is intact.

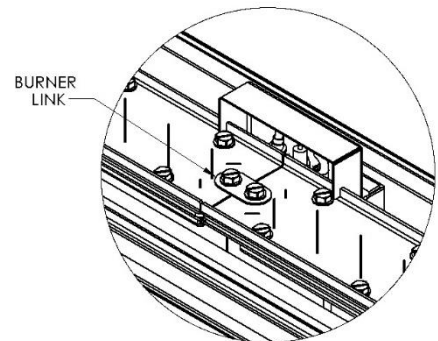

# GAS CONVERSION

8. When converting from Propane to Natural Gas, slide the NG Collar over the Burner inlet tube and use a 1/4" nut driver to secure with a #8 sheet metal screw.
9. When converting from Natural Gas to Propane, remove the NG Collar from the burner inlet tube.
10. Using a 9/16" deep socket, replace the burner orifice(s) in the firebox with those provided in the conversion kit.
11. Reinstall the burner(s) in the fireplace. Reinstall the burner link if required.
12. Using a flat screw driver, remove the Pressure Conversion Plug and set it to NG or LP accordingly.



## Gas Flow Adjustment

1. Install a gas pressure gage on the outlet pressure tap on the valve.
2. Light the fireplace using the remote handset.
3. With the fireplace on high, set the maximum pressure by adjusting the small flat screw set within the Pressure Conversion Plug. Refer to chart below for high pressure settings. (it may be necessary to lift the valve control bracket up out of the fireplace to access the pressure tap and minimum rate orifice)
4. double tap the down arrow to set the fireplace to low. "Lo" will momentarily appear on the display.
5. The minimum rate can be set by adjusting the minimum rate orifice. Refer to the chart below for Low pressure settings.
6. Close the pressure tap(s) by turning the screws clockwise. Check all connections/pressure taps for leaks.

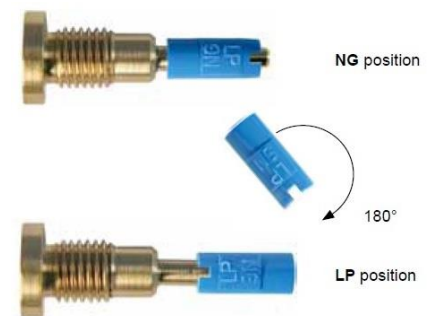
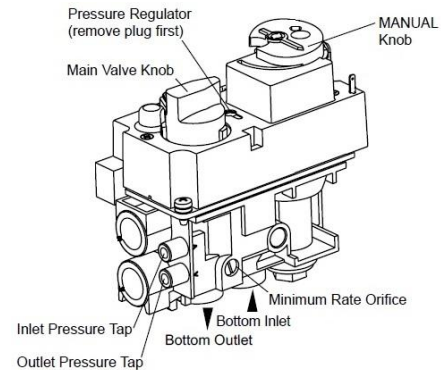

MODEL	HIGH PRESSURE (NG)	LOW PRESSURE (NG)	HIGH PRESSURE (LPG)	LOW PRESSURE (LPG)
FORTY8	3.9" w.c. / 1.0kPa	1.9" w.c. / 0.47kPa	10.0" w.c. / 2.5kPa	4.7" w.c. / 1.17kPa
SIXTY0	3.9" w.c. / 1.0kPa	1.9" w.c. / 0.47kPa	10.0" w.c. / 2.5kPa	4.7" w.c. / 1.17kPa
SEVENTY2	3.9" w.c. / 1.0kPa	2.2" w.c. / 0.55kPa	10.0" w.c. / 2.5kPa	4.7" w.c. / 1.17kPa

# MAINTENANCE

## ANNUAL MAINTENANCE

A qualified service agency should conduct an annual inspection and maintenance of your SÓLAS Gas Fireplace including the overall installation and venting to keep it running safely. The following procedures should be performed only by a qualified service person. The gas supply should be turned off and the stove should be completely cool whenever a maintenance procedure is performed. All parts of the appliance that are removed for servicing must be replaced prior to operation.

**This appliance should be inspected before use and at least annually by a qualified service person. More frequent cleaning may be required due to excessive dust or lint from carpeting, bedding materials, pets, etc. It is imperative that control compartments and circulating air passageways of this appliance be kept clean.**

## CLEANING THE BURNER AND FIREBOX

During the annual inspection and maintenance appointment, the service person should clean the burner and firebox. To gain access to the firebox and burner, follow the instructions beginning on page 18 of this manual.

### **DO NOT USE A VACUUM CLEANER TO CLEAN THE GLASS BURNER MEDIA.**

A vacuum cleaner may be used to clean the metal parts of the firebox. Leave the glass burner media in place. Use a soft brush to clean the burner glass media. If the burner media does need to be removed, carefully scoop it off the burner and avoid dropping glass pieces in the air gaps around the burner. Follow the instructions on page 22 of this manual when replacing the burner media on the burner top.

## AIR FLOW

The SÓLAS Gas Fireplace utilizes a convection air heat exchange system to maximize heat delivered from the fireplace. It is important that air flows freely through the convection air system and out the air grills. Do not place objects against the fireplace that will block the convection air inlet flow or in front of any air outlet.

## CLEANING THE GLASS AND GLOSS BLACK ENAMEL PANELS

After allowing the Fireplace to cool, use an ammonia-free glass cleaner and a soft, clean cloth to clean the Enamel Panels at the rear and side of the firebox. It is recommended that the Glass Enamel Panels be cleaned at least annually to avoid discoloration. More frequent cleaning may be required if contaminants are present in the gas supply or general atmosphere.

**WARNING: Never clean the Glass or Enamel Panels while they are hot. Do not use abrasive cleaners or cleaners containing ammonia.**

**NOTE:** It is recommended that a Micro-fiber cleaning cloth be used to clean the glass and enamel panels.

# MAINTENANCE LOG

We strongly recommend that you keep a log of the regular maintenance that is performed on your fireplace. We have provided the forms below to make it easy. Simply ask your qualified service person to fill out one of the maintenance record forms below, each time the fireplace is serviced. This will help insure that all of the required maintenance procedures have been completed, at least annually. Regular maintenance will help keep the fireplace functioning in a safe and reliable manner. Additional forms are available from your installer or service person when needed.

Date of Service _____
Serviced By _____
<u>Service Performed</u>
<input type="checkbox"/> Clean Burner & Firebox
<input type="checkbox"/> Clean Control Area
<input type="checkbox"/> Clean Convection Air System
<input type="checkbox"/> Leak Test Gas Connections
<input type="checkbox"/> Other _____

Date of Service _____
Serviced By _____
<u>Service Performed</u>
<input type="checkbox"/> Clean Burner & Firebox
<input type="checkbox"/> Clean Control Area
<input type="checkbox"/> Clean Convection Air System
<input type="checkbox"/> Leak Test Gas Connections
<input type="checkbox"/> Other _____

Date of Service _____
Serviced By _____
<u>Service Performed</u>
<input type="checkbox"/> Clean Burner & Firebox
<input type="checkbox"/> Clean Control Area
<input type="checkbox"/> Clean Convection Air System
<input type="checkbox"/> Leak Test Gas Connections
<input type="checkbox"/> Other _____

Date of Service _____
Serviced By _____
<u>Service Performed</u>
<input type="checkbox"/> Clean Burner & Firebox
<input type="checkbox"/> Clean Control Area
<input type="checkbox"/> Clean Convection Air System
<input type="checkbox"/> Leak Test Gas Connections
<input type="checkbox"/> Other _____

Date of Service _____
Serviced By _____
<u>Service Performed</u>
<input type="checkbox"/> Clean Burner & Firebox
<input type="checkbox"/> Clean Control Area
<input type="checkbox"/> Clean Convection Air System
<input type="checkbox"/> Leak Test Gas Connections
<input type="checkbox"/> Other _____

Date of Service _____
Serviced By _____
<u>Service Performed</u>
<input type="checkbox"/> Clean Burner & Firebox
<input type="checkbox"/> Clean Control Area
<input type="checkbox"/> Clean Convection Air System
<input type="checkbox"/> Leak Test Gas Connections
<input type="checkbox"/> Other _____

Date of Service _____
Serviced By _____
<u>Service Performed</u>
<input type="checkbox"/> Clean Burner & Firebox
<input type="checkbox"/> Clean Control Area
<input type="checkbox"/> Clean Convection Air System
<input type="checkbox"/> Leak Test Gas Connections
<input type="checkbox"/> Other _____

Date of Service _____
Serviced By _____
<u>Service Performed</u>
<input type="checkbox"/> Clean Burner & Firebox
<input type="checkbox"/> Clean Control Area
<input type="checkbox"/> Clean Convection Air System
<input type="checkbox"/> Leak Test Gas Connections
<input type="checkbox"/> Other _____

# MAINTENANCE LOG CONT.

Date of Service \_\_\_\_\_  
Serviced By \_\_\_\_\_  
Service Performed  
 Clean Burner & Firebox  
 Clean Control Area  
 Clean Convection Air System  
 Leak Test Gas Connections  
 Other \_\_\_\_\_

Date of Service \_\_\_\_\_  
Serviced By \_\_\_\_\_  
Service Performed  
 Clean Burner & Firebox  
 Clean Control Area  
 Clean Convection Air System  
 Leak Test Gas Connections  
 Other \_\_\_\_\_

Date of Service \_\_\_\_\_  
Serviced By \_\_\_\_\_  
Service Performed  
 Clean Burner & Firebox  
 Clean Control Area  
 Clean Convection Air System  
 Leak Test Gas Connections  
 Other \_\_\_\_\_

Date of Service \_\_\_\_\_  
Serviced By \_\_\_\_\_  
Service Performed  
 Clean Burner & Firebox  
 Clean Control Area  
 Clean Convection Air System  
 Leak Test Gas Connections  
 Other \_\_\_\_\_

Date of Service \_\_\_\_\_  
Serviced By \_\_\_\_\_  
Service Performed  
 Clean Burner & Firebox  
 Clean Control Area  
 Clean Convection Air System  
 Leak Test Gas Connections  
 Other \_\_\_\_\_

Date of Service \_\_\_\_\_  
Serviced By \_\_\_\_\_  
Service Performed  
 Clean Burner & Firebox  
 Clean Control Area  
 Clean Convection Air System  
 Leak Test Gas Connections  
 Other \_\_\_\_\_

Date of Service \_\_\_\_\_  
Serviced By \_\_\_\_\_  
Service Performed  
 Clean Burner & Firebox  
 Clean Control Area  
 Clean Convection Air System  
 Leak Test Gas Connections  
 Other \_\_\_\_\_

Date of Service \_\_\_\_\_  
Serviced By \_\_\_\_\_  
Service Performed  
 Clean Burner & Firebox  
 Clean Control Area  
 Clean Convection Air System  
 Leak Test Gas Connections  
 Other \_\_\_\_\_

# REPLACEMENT PARTS LIST

## GENERAL REPLACEMENT PARTS

PART NAME	P/N	PART NAME	P/N
Natural Gas (NG) Pilot Assy.	BI-401	TC Line Red	M46-701
Propane (LP) Pilot Assy.	BI-402	TC Line Yellow	M46-702
Receiver Module (Maxitrol)	M46-504	Thermocouple Interrupter Block	M46-703
Wall Switch Panel (Optional)	M46-505	8-Wire Connecting Cable	M46-704
Remote Handset (Maxitrol)	M46-507	Gas Valve (Maxitrol)	M46-515
Module for Additional Function	36-560	Replacement Blower	36-531
See-Thru Firebox Side Panel	48ST-202	Single-Side Firebox Side Panel	48SS-202
Firebox Enamel Panel – Rear	48SS-201	Blower Wire Harness (Single Side)	48SS-561
Blower Wire Harness (See-Thru)	48ST-561	LH & RH Trim panel (1 set)	48BI-540

## FORTY8 - REPLACEMENT PARTS

PART NAME	P/N	PART NAME	P/N
Burner Orifice (NG)	NGBI-48	Burner (NG)	48BI-301
Burner Orifice (LP)	LPBI-48	Burner (LP)	48BI-302
Burner Glass Media (Clear/Mixed)	48BI-200	Burner Conversion Kit (NG)	48BI-NGC
Burner Conversion Kit (LP)	48BI-LPC	Air Flow Trim Panel	48BI-550

## SIXTY0 - REPLACEMENT PARTS

PART NAME	P/N	PART NAME	P/N
Burner Orifice (NG)	NGBI-60	Firebox Enamel Panel - End	60BI-201
Burner Orifice (LP)	LPBI-60	Burner Module (NG) (2 req.)	60BI-301
Burner Glass Media (Clear/Mixed)	60BI-200	Burner Module (LP) (2 req.)	60BI-302
Burner Conversion Kit (NG)	60BI-NGC	Burner Conversion Kit (LP)	60BI-LPC

## SEVENTY2 - REPLACEMENT PARTS

PART NAME	P/N	PART NAME	P/N
Burner Orifice (NG)	NGBI-72	Firebox Enamel Panel - Center	72BI-201
Burner Orifice (LP)	LPBI-72	Burner Module (NG) (2 req.)	72BI-301
Burner Glass Media (Clear/Mixed)	72BI-200	Burner Module (LP) (2 req.)	72BI-302
Burner Conversion Kit (NG)	72BI-NGC	Burner Conversion Kit (LP)	72BI-LPC

# CONTROL SCHEMATIC

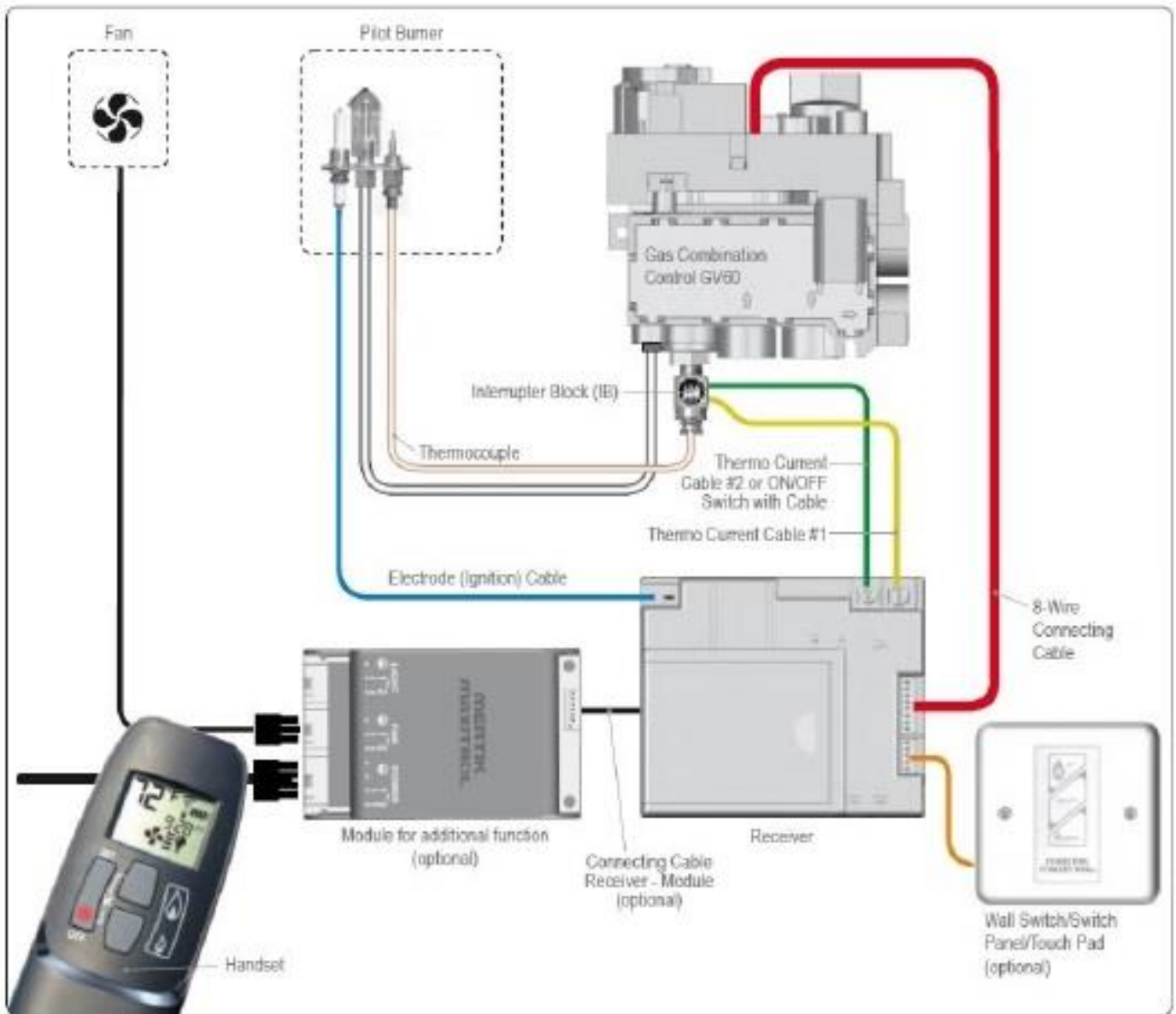

**Caution:** Label all wires prior to disconnection when servicing the controls. Wiring errors can cause improper and dangerous operation. Verify proper operation after servicing.

**For replacement parts and customer service contact your SÓLAS dealer or:**

**SÓLAS, LLC**  
4 Technology Drive, Suite 5  
West Lebanon, NH 03784

(T) 603-298-5169  
(F) 603-298-9246  
sales@solasfires.com



# INSTALLATION RECORD

The installer should complete the form below that describes the details of the installation. Having this written record of installation information available will greatly expedite trouble-shooting should any problem arise with your stove. The installer should keep a duplicate of this form for their records.

Date Purchased: \_\_\_\_\_

Dealer: \_\_\_\_\_

Date Installed: \_\_\_\_\_

Installer: \_\_\_\_\_

Fireplace Model: (circle one)      FORTY~~8~~      SIXTY~~0~~      SEVENTY~~2~~

Serial Number: \_\_\_\_\_ in. WC

Fuel: (circle one)      Natural Gas (NG)      Propane (LP)

Inlet Pressure (after installation): \_\_\_\_\_

Manifold Pressure (after Installation):      High Fire: \_\_\_\_\_ in. WC

Low Fire: \_\_\_\_\_ in. WC

Altitude: (feet above sea level) \_\_\_\_\_

Was the stove de-rated? (circle one)      Yes      No

If the stove was de-rated, to what orifice size? \_\_\_\_\_

Other installation notes: \_\_\_\_\_

\_\_\_\_\_

\_\_\_\_\_

\_\_\_\_\_

\_\_\_\_\_

\_\_\_\_\_

\_\_\_\_\_

# WARRANTY INFORMATION

## THE WARRANTY

SÓLAS, LLC, a division of Progressive Manufacturing, Inc. ("SÓLAS"), Limited Lifetime Warranty warrants your SÓLAS brand gas fireplace ("Product") to be free from defects in materials and workmanship at the time of manufacture. The Product body and firebox carry the Limited Lifetime Warranty on workmanship defects causing loss of structural integrity. Ceramic glass carries the Limited Lifetime Warranty against thermal breakage only. After installation, if covered components manufactured by SÓLAS are found to be defective in material or workmanship during the Limited Lifetime Warranty period and while the Product remains at the site of the original installation, SÓLAS will, at its option, repair or replace the covered components. If repair or replacement is not commercially practical, SÓLAS will, at its option, refund the purchase price or wholesale price of the SÓLAS product, whichever is applicable. SÓLAS will also pay their prevailing labor rates, as determined in its sole discretion, incurred in repairing or replacing such components during the warranty period. THERE ARE EXCLUSIONS AND LIMITATIONS to this Limited Lifetime Warranty as described herein.

## COVERAGE COMMENCEMENT DATE

Warranty coverage begins on the date of installation. The warranty shall commence no later than 24 months following the date of product shipment from SÓLAS, regardless of the installation date.

## EXCLUSIONS AND LIMITATIONS

This Limited Lifetime Warranty applies only if the Product is installed in the United States or Canada and only if operated and maintained in accordance with the printed instructions accompanying the Product and in compliance with all applicable installation and building codes and good trade practices.

This warranty is non-transferable and extends to the original owner only. The Product must be purchased through a listed supplier of SÓLAS and proof of purchase must be provided. The Product body and firebox carry the Limited Lifetime Warranty. The following do not carry the Limited Lifetime Warranty, but are warranted as follows:

- **Burner** – Repair or replacement for three years from date of installation.
- **Gas components & electrical components** – Repair or replacement for one year from date of installation.
- **Blowers & remote controls** – Repair or replacement for one year from the date of installation.
- **Porcelain Firebox Liners** – Replacement for one year against cracking or breakage due to thermal stress from date of installation. Excludes surface and hairline cracks and scratches or slight color changes that do not affect the operation or safety of the unit.
- **Gaskets** – Repair or replacement for one year from the date of installation.
- **Surrounds** – Replacement for one year against cracking or breakage due to thermal stress. Excludes surface and hairline cracks and scratches or slight color changes that do not affect the operation or safety of the unit.
- **Labor coverage** – Prevailing SÓLAS rates apply for the warranty period of the component. SÓLAS will not be liable for travel costs for service work.

SÓLAS will not be responsible for: (a) damages caused by normal wear and tear, accident, riot, fire, flood, or acts of God; (b) damages caused by abuse, negligence, misuse, or unauthorized alteration or repair of the Product affecting its stability or performance. The Product must be subjected to normal use. The product is designed to burn either natural or propane gas only. Burning conventional fuels such as wood, coal or any other solid fuel will cause damage to the Product, will produce excessive temperatures and could result in a fire hazard. (c) Damages caused by failing to provide proper maintenance and service in accordance with the instructions provided with the Product; (d) damages, repairs or inefficiency resulting from faulty installation or application of the Product.

Discoloration and some minor expansion, contraction, or movement of certain parts and resulting noise is normal and not a defect, and, therefore, not covered under warranty. The installer must ensure the appliance is burning as per the rating tag at the time of installation. Over-firing (operation above the listed BTU rate) of this appliance can cause serious damage and will nullify this warranty.

This warranty is void if:

- The unit has been operated in atmospheres contaminated by chlorine, fluorine or other damaging chemicals.
- The unit is subject to submersion in water or prolonged periods of dampness or condensation.
- Any damage to the unit, combustion chamber, heat exchanger or other components due to water or weather damage which is the result of, but not limited to improper chimney/venting installation.

Damage to stainless steel, gold, nickel or porcelain enameled surfaces caused by fingerprints, scratches, melted items, or other external sources left on these surfaces from the use of cleaners is not covered in this warranty.

SÓLAS is not responsible for inadequate fireplace system draft caused by air conditioning and heating systems, mechanical ventilation systems, or general construction conditions which may generate negative pressure in the room in which the appliance is installed. Additionally, SÓLAS assumes no responsibility for drafting conditions caused by venting configurations, adjoining trees or buildings, adverse wind conditions or unusual environmental factors and conditions that affect the operation of the unit.

This Limited Lifetime Warranty covers only parts and labor as provided herein. In no case shall SÓLAS be responsible for materials, components, or construction, which are not manufactured or supplied by SÓLAS or for the labor necessary to install, repair, or remove such materials, components, or construction. Additional utility bills incurred due to any malfunction or defect in equipment are not covered by this warranty. All replacement or repair components will be shipped F.O.B. from the nearest stocking SÓLAS facility.

## LIMITATION ON LIABILITY

It is expressly agreed and understood that SÓLAS' sole obligation and the purchaser's exclusive remedy under this warranty, under any other warranty, expressed or implied, or in contract, tort or otherwise, shall be limited to replacement, repair, or refund, as specified herein.

In no event shall SÓLAS be liable for any incidental or consequential damages caused by defects in the Product, whether such damage occurs or is discovered before or after repair or replacement, and whether such damage is caused by SÓLAS' negligence. SÓLAS has not made and does not make any representation or warranty of fitness for a particular use or purpose, and there is no implied condition of fitness for a particular purpose.

SÓLAS makes no expressed warranties except as stated in this Limited Lifetime Warranty. The duration of any implied warranty is limited to the duration of this expressed warranty.

No one is authorized to change this Limited Lifetime Warranty or to create for SÓLAS any other obligation or liability in connection with the Product. Some states and provinces do not allow the exclusion or limitation of incidental or consequential damages, so the above limitations or exclusions may not apply to you. The provisions of this Limited Lifetime Warranty are in addition to and not a modification of or subtraction from any statutory warranties and other rights and remedies provided by law.

## INVESTIGATION OF CLAIMS AGAINST WARRANTY

SÓLAS reserves the right to investigate any and all claims against this Limited Lifetime Warranty and to decide, in its sole discretion, upon the method of settlement.

To receive the benefits and advantages described in this Limited Lifetime Warranty, the appliance must be installed and repaired by a licensed contractor approved by SÓLAS.

Contact SÓLAS at the address provided herein to obtain a listing of approved dealers/distributors. **SÓLAS shall in no event be responsible for any warranty work done by a contractor that is not approved without first obtaining SÓLAS' prior written consent.**

## HOW TO REGISTER A CLAIM AGAINST WARRANTY

In order for any claim under this warranty to be valid, you must contact the SÓLAS dealer/distributor from which you purchased the product. If you cannot locate the dealer/distributor, then you must notify SÓLAS in writing. SÓLAS must be notified of the claimed defect in writing within 90 days of the date of failure. Notices should be directed to the SÓLAS Warranty Department at 4 Technology Drive, Suite 5, West Lebanon, NH 03784 or visit our website at [www.SOLASfires.com](http://www.SOLASfires.com).

## SÓLAS, LLC

4 Technology Drive, Suite 5

West Lebanon, NH 03784

(T) 603-298-5169

(F) 603-298-9246

[www.SOLASfires.com](http://www.SOLASfires.com)

**RECORD YOUR PRODUCT INFORMATION**

Model #: _____	Serial #: _____
Date Purchased: _____	Date Installed: _____



Manufactured by:  
Progressive Manufacturing Inc.  
4 Technology Drive, Suite 5  
West Lebanon, NH 03784  
USA