



Owner's Manual



Revillusion® 25" Electric Log Set Model RLG25 (6909760159)

IMPORTANT SAFETY INFORMATION: Read this manual first before attempting to install or use the Revillusion® Log Set. Always comply with the warnings and safety instructions contained in this manual to prevent personal injury or property damage.







To view the full line of Dimplex products,
visit www.dimplex.com



7214560100R04



Table of Contents

	Welcome.....	3
	IMPORTANT INSTRUCTIONS.....	4
	Installation	6
	Operation.....	9
	Maintenance	11
	Warranty	12
	Technical Support.....	14



SAVE THESE INSTRUCTIONS



Conventions used in this manual:

! NOTE: Procedures and techniques that are considered important enough to emphasize.

⚠ CAUTION: Procedures and techniques which, if not carefully followed, will result in damage to the equipment.

⚡ WARNING: Procedures and techniques which, if not carefully followed, will expose the user to the risk of fire, serious injury, or death.

Welcome

Thank you for purchasing a Revillusion® Log Set by Dimplex. Please use our convenient online registration page to record your model and serial numbers for future reference at:

www.dimplex.com/register

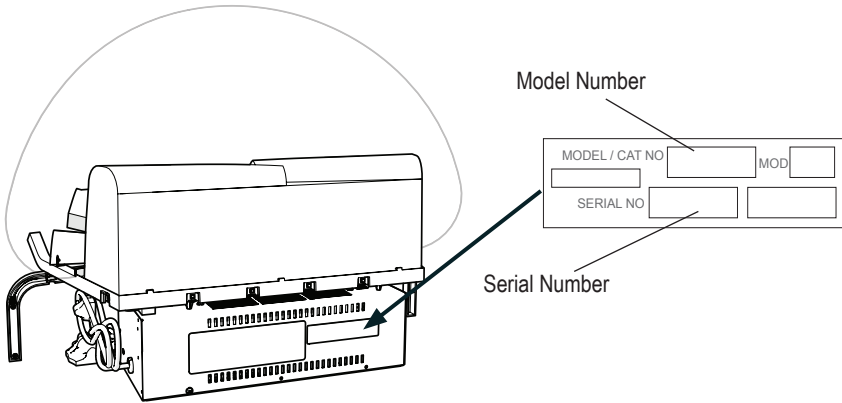

⚠ CAUTION: Read all instructions and warnings carefully before starting installation. Failure to follow these instructions may result in a possible electric shock or fire hazard and will void the warranty.



NO NEED TO RETURN TO THE STORE

Questions with operation or assembly? Require Parts Information?
Product Under Manufacturer's Warranty?

Contact us at:  **www.dimplex.com/customer_support**
For Troubleshooting and Technical Support

OR  **Toll-Free 1-888-346-7539**

In order to better serve you, please have your model and serial numbers ready or register your product online before calling (see above).

IMPORTANT INSTRUCTIONS

Basic Precautions

When using any electrical appliance, basic precautions should always be followed to reduce the risk of fire, electric shock, and injury to persons. These precautions include:

① Read all instructions before using the log set.

 **DANGER:** High temperatures may be generated under certain abnormal conditions. Do not partially or fully cover or obstruct the front of the log set.

② Extreme caution is necessary when any heater is used by or near children or invalids and whenever the unit is left operating and unattended.

③ Always unplug the log set when it is not in use.

④ Do not operate the log set with a damaged cord or plug or after the log set malfunctions, has been dropped, or damaged in any manner. Contact Technical Service at 1-888-346-7539.

⑤ Do not use this log set outdoors.

⑥ This log set is not intended for use in bathrooms, laundry areas, and similar indoor locations. Never locate the log set where it may fall into a bathtub or other water container.

⑦ Do not run power cord under carpeting. Do not cover cord with throw rugs, runners, or similar coverings. Do not route cord under furniture or appliances. Arrange cord away from traffic area and where it will not be tripped over.

⑧ To disconnect the log set, turn the control to Off, then remove plug from outlet.

⑨ Connect the power cord to a properly grounded outlet only.

⑩ Do not insert or allow foreign objects to enter any ventilation or exhaust opening as this may cause an electric shock or fire, or damage the log set. To prevent a possible fire, do not block air intakes or exhaust in any manner. Do not use on soft surfaces, like a bed, where openings may become blocked.

⑪ This log set has hot and arcing or sparking parts inside. Do not use it in areas where gasoline, paint, or flammable liquids are used or stored.

⑫ Use this log set only as described in this manual. Any other use not recommended by the manufacturer may cause fire, electric shock, or injury to persons.

⑬ Always plug the log set directly into a wall outlet/receptacle. Never use with an extension cord or relocatable power tap (outlet/power strip).

⑭ Do not burn wood or other materials on the log set.

IMPORTANT INSTRUCTIONS

Special Precautions

 **WARNING:** Remote control contains a small battery. Keep away from children. If swallowed, seek medical attention immediately.

 **WARNING:** Do not install battery backwards, charge, put in fire or mix with used or other battery types as it may explode or leak causing injury.

 **CAUTION:** Do not open the unit. There is a risk of electric shock. There are no user-serviceable parts inside.

 **CAUTION:** Always use a qualified technician or service agency to repair this unit.

FCC Compliance

 **CAUTION:** This unit has been tested and found to comply with the limits for Class B digital device, pursuant to part 15 of the FCC Rules. These limits are designed to provide reasonable protection against harmful interference in a residential installation. This unit generates, uses and can radiate radio frequency energy and, if not installed and used in accordance with the instructions, may cause harmful interference to radio or television reception, which can be determined by turning the unit OFF and ON, the user is encouraged to try to correct the interference by one or more of the following measures:

- Reorient or relocate the receiving antenna.
- Increase the separation between the unit and the receiver.
- Connect the unit into an outlet on a circuit different from that to which the receiver is connected.
- Consult the dealer or an experienced radio/TV technician for help.

This unit complies with Part 15 of the FCC Rules. Operation is subject to the following two conditions: (1) This unit may not cause harmful interference, and (2) this unit must accept any interference received, including interference that may cause undesired operation.

 **FCC CAUTION:** Any changes or modifications not expressly approved by the party responsible for compliance could void the user's authority to operate this equipment.



CAUTION
RISK OF ELECTRIC SHOCK
DO NOT OPEN
NO USER-SERVICEABLE PARTS INSIDE



Installation

The Revillusion® Log Set offers an alternative to wood or gas fireplaces. It can give your existing fireplace new life or transform a cabinet or media center of your own into a stunning focal point.

Specifications

Electrical

Volts: 120 V, 60 Hz

Amps: 12.5 A

Watts: 1500 W

Wiring: Plug-In

Bulb Type: LED

Approvals 

Dimensions

Width: 25.6" (635 mm)

Height: 19.0" (483 mm)

Depth: 13.0" (330 mm)

Weight: 12 lbs (5.4 kg)

Operating Temperature Range:

-4° to 104° F (-20° to 40° C)

! NOTE: A 15 Amp, 120 Volt circuit is required. A dedicated circuit is preferred, but not essential in all cases. A dedicated circuit will be required if, after installation, the circuit breaker trips or the fuse blows on a regular basis when the heater is operating. Additional appliances on the same circuit may exceed the current rating of the circuit breaker.

⚠ WARNING: Electrical outlet wiring must comply with local building codes and other applicable regulations to reduce the risk of fire, electric shock, or injury to persons.

Placement

1. The Revillusion log set does not require any special venting. Install the unit in an opening with the minimum dimensions:
A. 26" (660 mm) wide,
B. 22" (559 mm) high
C. 15" (381 mm) deep.

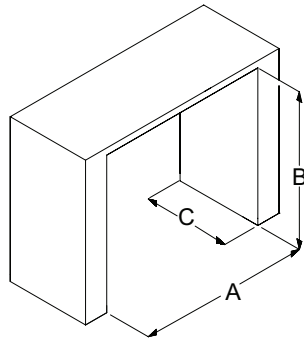

2. Make sure there is clearance for air circulation beneath the unit.
3. If installing in an existing fireplace opening, seal all drafts and vents with a non-fibrous insulation material to prevent any chimney debris from falling onto the unit. Do not install into an existing fireplace opening that is prone to dampness.

Installation

Assembly

1. Place the log set into position.
 - a. Lift the log set by holding the sides of the heater box for stability. Do not lift by gripping the logs or the grate front legs.
 - b. If installing the unit in a carpeted area, place a one-piece, solid, flat surface under the unit. Make sure that both of the grate feet rest securely on this surface.

⚠ CAUTION: Each of the Realogs™ contain LEDs that pulse and glow. Handle the log set carefully. They are fragile and can crack or break if dropped.

2. Place the ember mat in front and below the grate.
3. Connect the wires from the ember mat to the connector on the right side of the grate box.

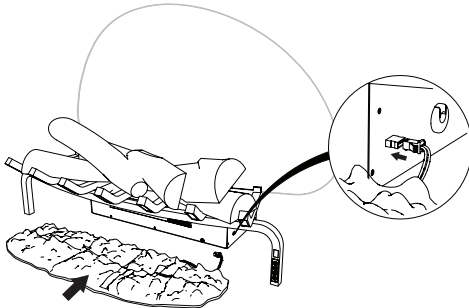

4. Install the Mirage™ Flame Panel by inserting the bottom edge into the tabs between the back log and grate log assemblies.

The painted side should be at the back and the smooth side to the front.

Position the screen so that the cutout in the middle aligns with the center tab. Start on one end to insert the screen in all the way across. When in place, the screen should be centered and slightly curved.

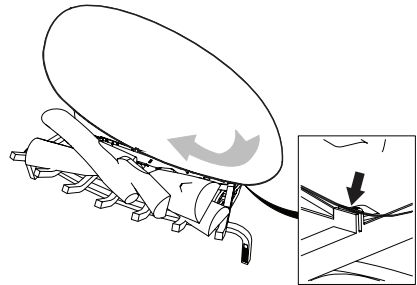

5. Plug the unit directly into a wall outlet.

Installation

Grounding Instructions

This product must be grounded. If it should malfunction or breakdown, grounding provides a path of least resistance for electric current to reduce the risk of electric shock. This product is equipped with a cord having an equipment-grounding conductor and a grounding plug.

The plug must be plugged into an appropriate outlet that is properly installed and grounded in accordance with all local codes and ordinances.

 DANGER: Improper connection of the equipment-grounding conductor can result in a risk of electric shock. Check with a qualified electrician or serviceman if you are in doubt as to whether the product is properly grounded. Do not modify the plug provided with the product – if it will not fit the outlet, have a proper outlet installed by a qualified electrician.

This product is for use on a nominal 120-volt circuit and has a grounding plug that looks like the plug in the following figure. Make sure that the product is connected to an outlet having the same configuration as the plug. No adapter should be used with this product.

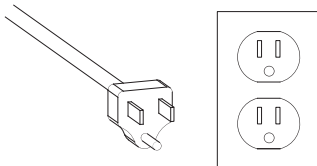

🔑 Operation

Manual Control

The manual controls for the Revillusion are located on the right-front leg of the log grate.

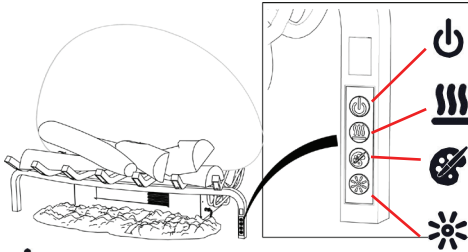

Power

Press to turn the flame effect on and activate the previous heat setting (Off, Low, or High). Press again to put the unit in standby mode.



Heat

- **Heat On**
Press to set the heat to Low (indicated by 1 short beep). Press again to set the heat to High (indicated by 2 short beeps).
- **Heat Off**
Press to turn heat Off (indicated by 1 long beep).

! NOTE: After the heater is switched off, the fan will continue on for 60 seconds before turning off. The log LEDs remain On when the heater is ON and the flame effect is Off.



Color Themes

Press multiple times to change the LED lights from: flame base yellow, flame base blue, flame

base yellow with yellow 360 LEDs, flame base blue with 360 LEDs. (Feature is active only when the flame effect is On.)



Brightness

Press multiple times to toggle the log set LEDs through its four brightness settings.

Remote Control

The fireplace is supplied with a multi-function remote control.

The remote control has a range of approximately 30ft (9m). To operate correctly, the remote control must be pointed toward the front of the unit.

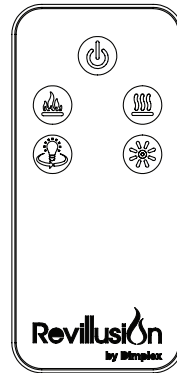

Power

Press to activate the current standby state (On/Off).

- **Standby State On**
Press to turn everything Off. Press again to activate the previous flame effect state.
- **Standby State Off**
Press to activate the previous flame effect state.

Operation

- If the flame effect was On, the previous heat setting will be activated (High, Low, or Off).
- If the flame effect was Off, the previous heat setting will be activated (High or Low).

Press again to turn everything Off.



Flame

Press to light the back log, grate log, and ember mat, and start the flame effect.



Heat

Heat On

Press to set the heat to Low (indicated by 1 short beep). Press again to set the heat to High (indicated by 2 short beeps).

- Heat Off
Press to turn heat Off (indicated by 1 long beep).

! NOTE: After the heater is switched off, the fan will continue on for 60 seconds before turning off. The log LEDs remain On when the heater is ON and the flame effect is Off.



360° Light

Press multiple times to change the LEDs on the sides and back of the unit from natural yellow flickering to yellow solid to white flickering to white solid to Off. (Feature is active only when the flame effect is On.)



Brightness

Press multiple times to toggle the log set LEDs through its four brightness settings.



Color Themes

Press multiple times to change the flame base colors from Yellow to Blue to Off. (Feature is active only when the flame effect is On.)



Maintenance

General Maintenance

Inspect the log set regularly, depending upon conditions, and at a minimum yearly intervals. Remove dust and clean the logs, mat, grate, and base as required.

Except for installation and cleaning described in this manual, an authorized service representative should perform any other servicing.

⚠ WARNING: Disconnect power and allow heater to cool before attempting any maintenance or cleaning to reduce the risk of fire, electric shock, or injury.

Clean Logs and Base

The log set should not be operated with an accumulation of dust or dirt on or in the unit, as this can cause a build up of heat and eventual damage.

Dust and vacuum the log set as needed. Use a damp cloth and a mild detergent to clean painted surfaces of the fireplace. Never use abrasive cleaners.

Clean Mirage™ Flame Panel

The Mirage™ Flame Panel is cleaned in the factory during the assembly operation. During shipment, installation, handling, etc., the screen may collect dust particles; these can be removed by dusting lightly with a clean dry cloth.

To remove fingerprints or other marks, clean the Mirage™ Flame Panel with a damp cloth. Never use abrasive cleaners. Dry the screen completely with a lint free cloth to prevent water spots.

Battery Replacement

To replace the battery:

1. Push the release tab toward the center and slide the battery cover open.
2. Install 3V Lithium battery in the battery holder. The positive (+) side of the battery faces up.
3. Close the battery cover.



Battery must be recycled or disposed of properly. Check with your Local Authority or Retailer for recycling advice in your area.



Warranty

Two Year Limited Warranty

Products to which this limited warranty applies

This limited warranty applies to your newly purchased Dimplex cassette and to newly purchased Dimplex fireplace surrounds (mantels) and trims. This limited warranty applies only to purchases made in any province of Canada except for Yukon Territory, Nunavut, or Northwest Territories or in any of the 50 States of the USA (and the District of Columbia) except for Hawaii and Alaska. This limited warranty applies to the original purchaser of the product only and is not transferable.

Products excluded from this limited warranty

Logset assemblies are only covered for transportation to the end user and will not be covered if damage occurs during normal operation and/or maintenance. Products purchased in Yukon Territory, Nunavut, Northwest Territories, Hawaii, or Alaska are not covered by this limited warranty. Products purchased in these States, provinces, or territories are sold AS IS without warranty or condition of any kind (including, without limitation, any implied warranties or conditions of merchantability or fitness for a particular purpose) and the entire risk of as to the quality and performance of the products is with the purchaser, and in the event of a defect the purchaser assumes the entire cost of all necessary servicing or repair.

What this limited warranty covers and for how long

Products, other than fireplace surrounds (mantels) and trims, covered by this limited warranty have been tested and inspected prior to shipment. Subject to the provisions of this warranty, Glen Dimplex Americas Ltd. (herein called Glen Dimplex Americas) warrants such products to be free from defects in material and workmanship for a period of 2 years from the date of the first purchase of such products as follows: (a) a

repair or replacement warranty on defective products or parts, including in-home services, for the first year following the date of first purchase; and (b) thereafter, a replacement of parts warranty on defective products and parts (with no in-home services) for the 1 year period commencing on the first anniversary of first purchase and ending on the second anniversary of the date of first purchase.

Glen Dimplex Americas fireplace surrounds (mantels) and trims covered by this limited warranty have been tested and inspected prior to shipment and, subject to the provisions of this warranty, Glen Dimplex Americas warrants such products to be free from defects in material and workmanship for a period of 1 year from the date of first purchase of such products. Warranty services do not include in-home services.

The limited 2 year warranty period for products other than fireplace surrounds (mantels) and trims and the limited 1 year warranty period for fireplace surrounds (mantels) and trims also applies to any implied warranties that may exist under applicable law. Some jurisdictions do not allow limitations on how long an implied warranty lasts, so the above limitation may not apply to the purchaser.

What this limited warranty does not cover

This limited warranty does not apply to products that have been repaired (except by Glen Dimplex Americas or its authorized service representatives) or otherwise altered. This limited warranty does further not apply to defects resulting from misuse, abuse, accident, neglect, incorrect installation, improper maintenance or handling, or operation with an incorrect power source.

What you must do to get service under this limited warranty

Defects must be brought to the attention of Technical Service at 1-888-346-7539. Please have proof of purchase, catalogue/model and serial numbers available when calling. Limited

Warranty

warranty service requires a proof of purchase of the product.

What Glen Dimplex Americas will do in the event of a defect

In the event a product or part covered by this limited warranty is proven to be defective in material or workmanship during (i) the 2 year limited warranty period for products other than fireplace surrounds (mantels) and trims, and (ii) the 1 year limited warranty period for surrounds (mantels) and trims, you have the following rights:

- Limited warranty service will be performed solely by dealers or service agents of Glen Dimplex Americas authorized to provide limited warranty services.
- **For products (other than surrounds (mantels) and trims) for the period ending at midnight on the first anniversary of the date of first purchase,** Glen Dimplex Americas will in its sole discretion either repair or replace such defective product or part without charge. If Glen Dimplex Americas is unable to repair or replace such product or part, or if repair or replacement is not commercially practicable or cannot be timely made, Glen Dimplex Americas may, in lieu of repair or replacement, choose to refund the purchase price for such product or part. *This limited warranty entitles the purchaser to on-site or in-home warranty services.* Accordingly, Glen Dimplex Americas will be responsible for all labour and transportation costs associated with the repair or replacement of the product or part except as follows: (i) charges may be levied for travel costs incurred to travel to the purchaser's site where the product is located if the purchaser's site is beyond 30 miles (48 km) from the closest service depot of Glen Dimplex Americas dealer or service agent; and (ii) the purchaser is solely responsible for providing clear access to all serviceable parts of the product.
- **For products (other than surrounds (mantels) and trims) for the period commencing at 12:01 a.m. on the day after the first anniversary of the first purchase and ending at midnight on the second anniversary of the date of first purchase,** this limited warranty entitles the purchaser to replacement parts only without charge. If Glen Dimplex Americas is unable to replace such part, or if replacement is not commercially practicable or cannot be timely made, Glen Dimplex Americas may, in lieu of replacement, choose to refund the purchase price for such part. The purchaser shall not be entitled to on-site or in-home warranty services. The purchaser shall be responsible for all expenses incurred for the removal of the part and installation of the replacement part including, without limitation, all shipping costs and transportation costs to and from the authorized dealer's or service agent's place of business and all labour costs. Such costs shall not be the responsibility of Glen Dimplex Americas.
- **For surrounds (mantels) and trims for the period ending at midnight on the first anniversary of the date of first purchase,** Glen Dimplex Americas will in its sole discretion either repair or replace such defective surrounds (mantels) and trims or part thereof without charge. If Glen Dimplex Americas is unable to repair or replace such product or part, or if repair or replacement is not commercially practicable or cannot be timely made, Glen Dimplex Americas may, in lieu of repair or replacement, choose to refund the purchase price for such product or part. The purchaser shall not be entitled to on-site or in-house services. The purchaser is responsible for all expenses incurred for repair or replacement of such product or part including, without limitation, all shipping costs and transportation costs to and from the authorized dealer's or service agent's business and all labour costs. Such

Warranty

costs shall not be the responsibility of Glen Dimplex Americas.

- On-site or in-home services not provided under this warranty may be performed at the purchaser's specific request and expense at Glen Dimplex Americas then-current rates for such services.

What Glen Dimplex Americas and its dealers and service agents are also not responsible for:

IN NO EVENT WILL GLEN DIMPLEX AMERICAS, OR ITS DIRECTORS, OFFICERS, OR AGENTS, BE LIABLE TO THE PURCHASER OR ANY THIRD PARTY, WHETHER IN CONTRACT, IN TORT, OR ON ANY OTHER BASIS, FOR ANY INDIRECT, SPECIAL, PUNITIVE, EXEMPLARY, CONSEQUENTIAL, OR INCIDENTAL LOSS, COST, OR DAMAGE ARISING OUT OF OR IN CONNECTION WITH THE SALE, MAINTENANCE, USE, OR INABILITY TO USE THE PRODUCT, EVEN IF GLEN DIMPLEX AMERICAS OR ITS DIRECTORS, OFFICERS, OR

AGENTS HAVE BEEN ADVISED OF THE POSSIBILITY OF SUCH LOSSES, COSTS OR DAMAGES, OR IF SUCH LOSSES, COSTS, OR DAMAGES ARE FORESEEABLE. IN NO EVENT WILL GLEN DIMPLEX AMERICAS, OR ITS OFFICERS, DIRECTORS, OR AGENTS BE LIABLE FOR ANY DIRECT LOSSES, COSTS, OR DAMAGES THAT EXCEED THE PURCHASE PRICE OF THE PRODUCT.

SOME JURISDICTIONS DO NOT ALLOW THE EXCLUSION OR LIMITATION OF INCIDENTAL OR CONSEQUENTIAL DAMAGES, SO THE ABOVE LIMITATION OR EXCLUSION MAY NOT APPLY TO THE PURCHASER.

How State and Provincial law apply

This limited warranty gives you specific legal rights, and you may also have other rights which vary from jurisdiction to jurisdiction. The provisions of the United Nations Convention on Contracts for the Sale of Goods shall not apply to this limited warranty or the sale of products covered by this limited warranty.

Technical Support

Technical and troubleshooting support, as well as a list of replacement parts can be found on:

www.dimplex.com/customer_support.

1-888-346-7539 | www.dimplex.com

In keeping with our policy of continuous product improvement, we reserve the right to make changes without notice.

© 2019 Glen Dimplex Americas

GlenDimplex
AMERICAS
Enhancing the moments that matter in life