

SURFACE VITRÉE: 193.252 PO²

CARTOUCHE V20	FABRICANT DE POÊLES INTERNATIONAL INC. 250, rue de Copenhague, Saint-Augustin-de-Desmaures (Québec) G3A 2H3 Tél : (418) 878-3040 Fax : (418) 878-3001 www.sbi-international.com		TOLÉRANCES FRACTION : ± 1/32" .XX : ±.020" .XXX : ±.010" ANGLES : ±0.5°	 THESE ALLOWANCES ARE NOT CUMULATIVE
	NOM DE LA PIÈCE / PART NAME POÊLE OSBURN SOHO / OSBURN SOHO STOVE		RÉVISIONS / REVISIONS 01A 14/05/2014	
CONCEPTEUR E. Blouin	DESSINATEUR J-P Alain	PAGE 3 de 5	DESSIN / DRAWING NBR OB01520-W01	

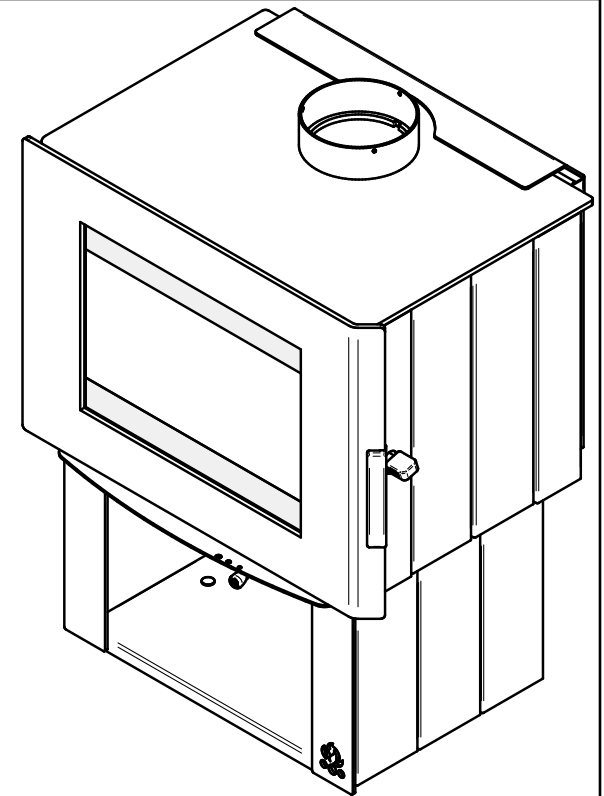
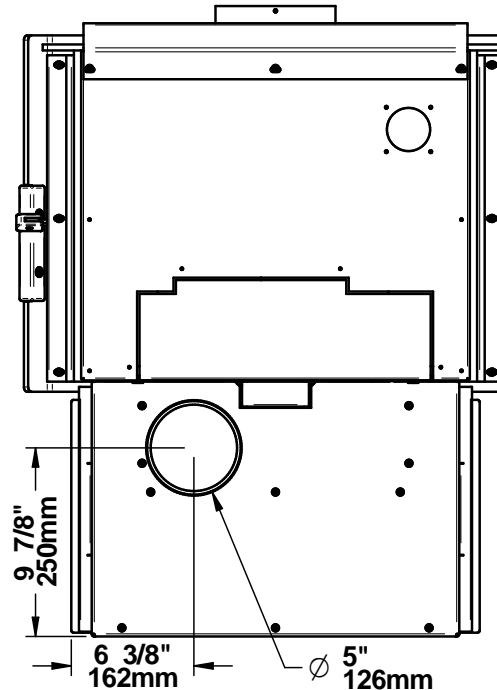
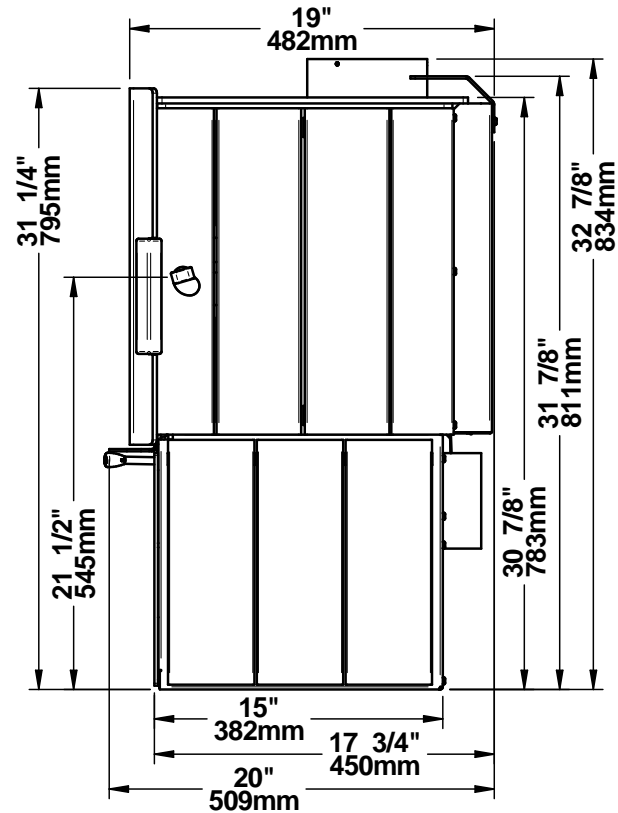
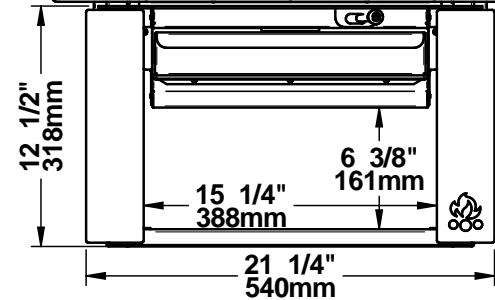
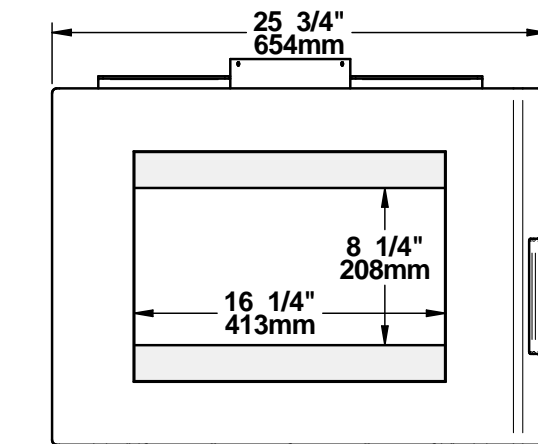
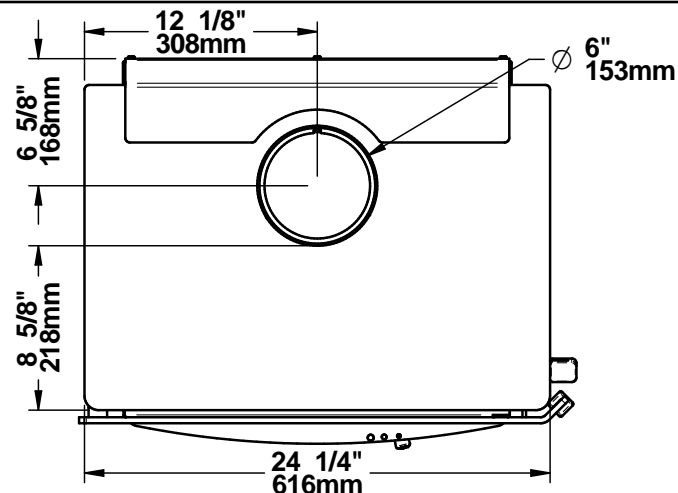

SURFACE VITRÉE: 193.252 PO²

CARTOUCHE V20	FABRICANT DE POÊLES INTERNATIONAL INC. 250, rue de Copenhague, Saint-Augustin-de-Desmaures (Québec) G3A 2H3 Tél : (418) 878-3040 Fax : (418) 878-3001 www.sbi-international.com		TOLÉRANCES FRACTION : ± 1/32" .XX : ±.020" .XXX : ±.010" ANGLES : ±0.5°	 THESE ALLOWANCES ARE NOT CUMULATIVE
	NOM DE LA PIÈCE / PART NAME POÊLE OSBURN SOHO / OSBURN SOHO STOVE		RÉVISIONS / REVISIONS 01A 14/05/2014	
CONCEPTEUR E. Blouin	DESSINATEUR J-P Alain	PAGE 4 de 5	DESSIN / DRAWING NBR OB01520-W01	

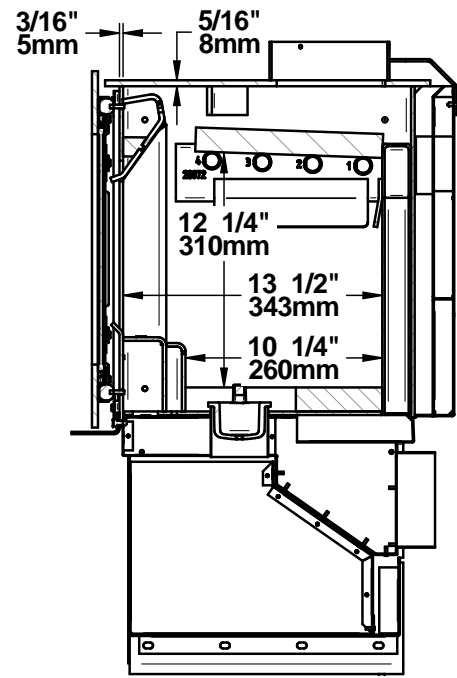

SECTION A-A

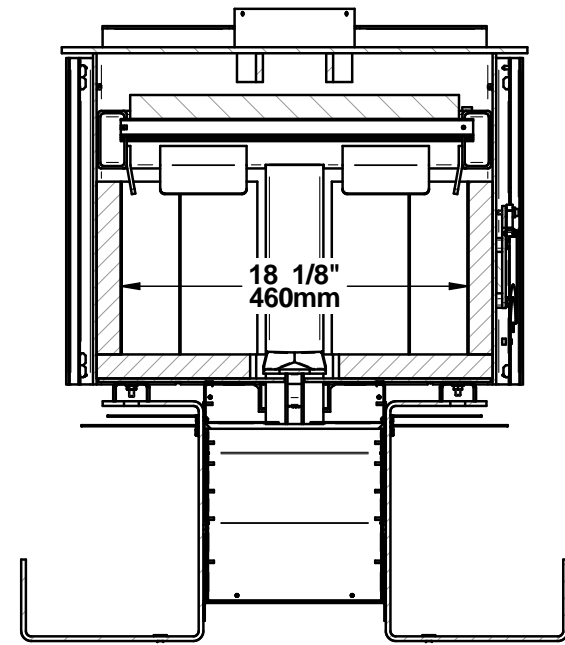

SECTION B-B

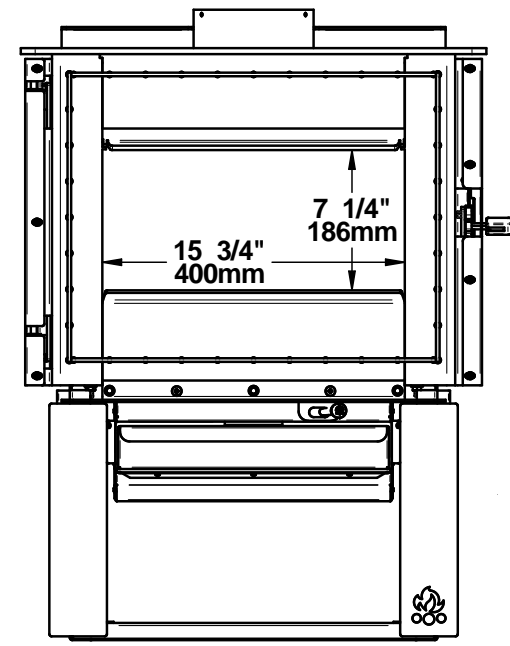
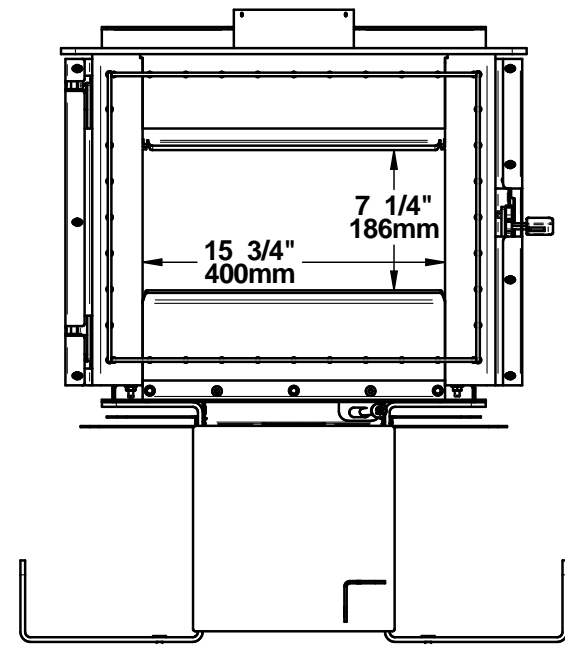

VOLUME CHAMBRE À COMBUSTION:
 2997.4218 PO³ / 1.7346 PI³
 0.04891 M³

CARTOUCHE V20	FABRICANT DE POÊLES INTERNATIONAL INC. 250, rue de Copenhague, Saint-Augustin-de-Desmaures (Québec) G3A 2H3 Tél : (418) 878-3040 Fax : (418) 878-3001 www.sbi-international.com		TOLÉRANCES FRACTION : ± 1/32" .XX : ±.020" .XXX : ±.010" ANGLES : ±0.5°	 THESE ALLOWANCES ARE NOT CUMULATIVE
	NOM DE LA PIÈCE / PART NAME POÊLE OSBURN SOHO / OSBURN SOHO STOVE		RÉVISIONS / REVISIONS 01A 14/05/2014	
CONCEPTEUR E. Blouin		DESSINATEUR J-P Alain		PAGE 5 de 5
				DESSIN / DRAWING NBR OB01520-W01