



# SERENE

ZERO CLEARANCE DIRECT VENT GAS FIREPLACE

**Unit Illustrated:** ZCVRB60N Zero Clearance Direct Vent Gas Fireplace (Natural Gas), MOSTONE Decorative Stones, ZCVRB60PL Porcelain Liners.  
(Shown with Vented Chase Option – VL60EG Front Enclose Grill)

 marquis  
COLLECTION

## SERENE 47 AND 60

# FEELING SERENE?

At the end of a busy day, cozy up to the new **SERENE** by Marquis. With beautiful designer details and the highest quality craftsmanship, **SERENE** combines pure comfort with a wow factor that comes from your choice of rocks and driftwood, decorative stones, cannonballs or ember glass. Relax and unwind the **SERENE** way.

Visit [www.marquisfireplaces.net](http://www.marquisfireplaces.net) to see the latest evolution in fireplaces.

### STANDARD FEATURES

- Hi/Low Millivolt or IPI valve system will operate during power failures
- Bronze Glass
- Mobile Home, Bedroom and Bed Sitting Room approved
- Proflame II® Models include remote control – features flame, fan, thermostat, smart-thermostat and LED lights
- Safety Screen Barrier

### OPTIONAL FEATURES

**Surround:** Black or Stainless Steel

**Fan Kit:** Heat activated with variable speed control

**Universal Light Kit:** Two Lamps (accent lighting)

**Wall Mount Thermostat:** Standard on/off or Programmable 5 day (weekday) and 2 day (weekend)

**Driftwood Log Sets:** Three Piece Driftwood Set (MQ46D), Four Piece Driftwood with Four Rocks (MQRBD1), Three Piece Driftwood Log Set (MQRBD4) or Five Piece Driftwood Set (MQRBD3)

**Media Options:** Contemporary Rocks, Decorative Stones, Decorative Ember Glass (Glacier Ice, Cobalt Blue, Black, Bronze, White), Ember Chunks or Multi-Colored Cannonballs

**Liners:** Porcelain Reflective, Fluted Brick (Serene 47), or Stacked Stone (Serene 60)

**Remote Controls:** Thermostat on/off, Thermostat on/off modulating, Thermostat on/off modulating, fan control and lights

#### Enclosure Grill Opening:

Front – SERENE 47      46 ¾" W x 2 ⅝" H

Front – SERENE 60      60 ⅝" W x 3 ⅝" H

Sides – SERENE 47/60    15 ¼" W x 6 ⅝" H



PF2



PF1



GFRC





# SERENE 47

## SERENE 47 PRODUCT SPECIFICATIONS

<b>MODEL</b>	ZCVRB47N/NE MQZCVRB47NE2 <sup>†</sup>	ZCVRB47LP/LPE MQZCVRB47LPE2 <sup>†</sup>
<b>Fuel</b>	Natural	Propane
<b>Gas Control</b>	Millivolt / IPI	Millivolt / IPI
<b>Input Max.</b>	24,500 BTU	24,500 BTU
<b>Input Min.</b>	16,500 BTU	20,500 BTU
<b>FE (P.4.1-15)</b>	55.26% / 57.31%	55.01% / 57.10%
<b>Glass Size</b>	40 5/8"W x 13 7/8"H	40 5/8"W x 13 7/8"H
<b>Venting</b>	4"/7" Flex or 4" x 6 5/8" Hard Pipe	4"/7" Flex or 4" x 6 5/8" Hard Pipe

## VENTED CHASE OPTION

### WITH OPENINGS (NO GRILLS)

Min. Enclosure Height  
Min. Opening Below Ceiling

## SERENE 47

Min. 105 sq/in.  
70"  
1-1/4"

### WITH GRILLS (MIN. AIR FREE OPENINGS)

Min. Enclosure Height  
Grill Opening (Max. distance from top of enclosure)

105 sq/in.  
70"  
2"

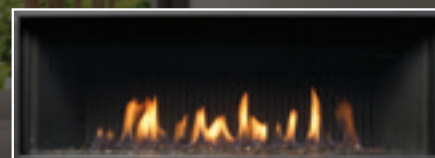

ZCVRB47N Zero Clearance Direct Vent Gas Fireplace (Natural Gas),  
MOEMBER Ember Chunks, MQZCVRB47RLF Fluted Liners.

**Unit Illustrated:** ZCVRB47N Zero Clearance Direct Vent Gas Fireplace (Natural Gas), ZCVRB47S1SS Surround Stainless Steel, MQ46D Driftwood Log Set, ZCVRB47PL Porcelain Liners, and MQSTONE10 Decorative Stones.



Unit Illustrated: ZCVRB47N Zero Clearance Direct Vent Gas Fireplace (Natural Gas), MQZCVRB47RLF Fluted Liner. (Shown as a Vented Chase – top of chase is open.)

## SERENE 47 PRODUCT DIMENSIONS

FRONT VIEW

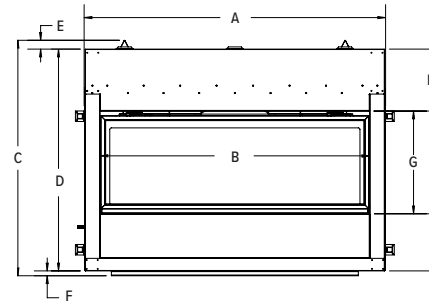

SIDE VIEW

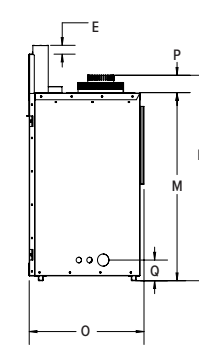

- A 46 5/8"
- B 41 5/8"
- C 38 5/8"
- D 35 1/16"
- E 2 1/4"
- F 3/4"
- G 15 7/8"
- H 11"
- I 8 13/16"
- J 34 5/8"
- K 17 3/4"
- L 11 1/16"
- M 29 1/16"
- N 31 1/16"
- O 17 3/4"
- P 2 1/16"
- Q 3 3/16"

TOP VIEW

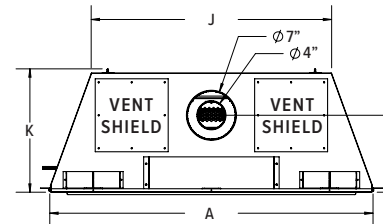

### FIREPLACE DIMENSIONS

Width	Height	Depth
46 5/8"	38 5/8"	17 3/4"

### FRAMING DIMENSIONS

Width	Height	Depth
47"	38 3/4"	18 1/4"

\*dependent of finishing material used.

## OPTIONAL WALL SURROUND

FRONT VIEW

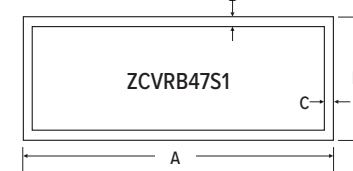

- A 44 5/8"
- B 1 1/2"
- C 1 1/2"
- D 17 3/4"
- E 1"
- F 1 3/4"

## OPTIONAL SIDE GRILL – VL60EGS

FRONT VIEW

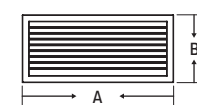

SIDE VIEW

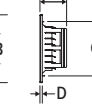

TOP VIEW



- A 16 3/16"
- B 7 7/8"
- C 6 7/16"
- D 1/4"
- E 15 7/16"
- F 2 9/16"

## OPTIONAL FRONT ENCLOSURE GRILL – V46EG

FRONT VIEW

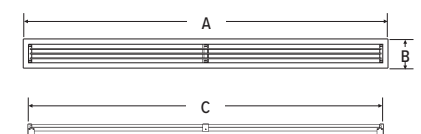

SIDE VIEW

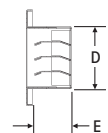

- A 47 13/16"
- B 3 13/16"
- C 46 9/16"
- D 2 1/2"
- E 1 9/16"



# SERENE 60

## SERENE 60 PRODUCT SPECIFICATIONS

<b>MODEL</b>	ZCVRB60N ZCVRB60NE MQZCVRB60NE2	ZCVRB60LP ZCVRB60LPE MQZCVRB60LPE2
<b>Fuel</b>	Natural	Propane
<b>Gas Control</b>	Millivolt / IPI	Millivolt / IPI
<b>Input Max.</b>	35,000 BTU	35,000 BTU
<b>Input Min.</b>	23,000 BTU	28,000 BTU
<b>FE (P.4.1-15)</b>	55.27%/56.66%	55.27%/56.66%
<b>Glass Size</b>	60"W x 17 7/8"H	60"W x 17 7/8"H
<b>Venting</b>	5"/8"	5"/8"

### VENTED CHASE OPTION

#### WITH OPENINGS (NO GRILLS)

Min. Enclosure Height

Min. Opening Below Ceiling

#### WITH GRILLS (MIN. AIR FREE OPENINGS)

Min. Enclosure Height

Grill Opening (Max. distance from top of enclosure)

### SERENE 60

Min. 200 sq/in.

76"

1-7/8"

220 sq/in.

76"

3/4"



ZCVRB60N Zero Clearance Direct Vent Gas Fireplace (Natural Gas), MQG5W Glass Media (White x2), ZCVRB60PL Porcelain Liners.

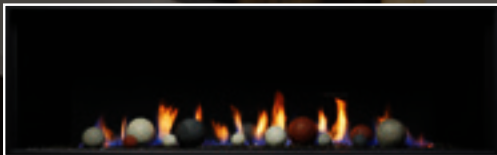

ZCVRB60N Zero Clearance Direct Vent Gas Fireplace (Natural Gas), RBCB1 Cannonballs, ZCVRB60PL Porcelain Liners.

**Unit Illustrated:** MQZCVRB60NE2 Zero Clearance Direct Vent Gas Fireplace (Natural Gas), ZCVRB60S1BL Surround (Black), MQ46D Driftwood Log Set, MQSTONE10 Decorative Stones, MQVL60RLSB Liner (Stacked Brick). (Shown as a Vented Chase – top of chase is open.)



Unit Illustrated: MQZCVRB60NE2 Zero Clearance Direct Vent Linear Gas Fireplace (Natural Gas), MQROCK3 Multi-Colored Rock Set, ZCVRB60PL Porcelain Liners. (Shown as a Vented Chase with Optional VL60EG – Front Enclosure Grill)



## SERENE 60 PRODUCT DIMENSIONS

FRONT VIEW

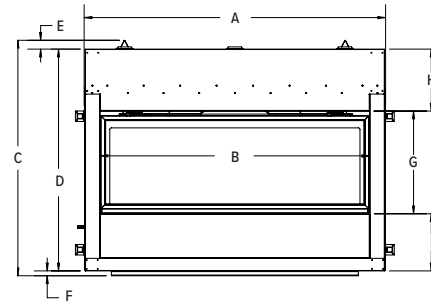

SIDE VIEW

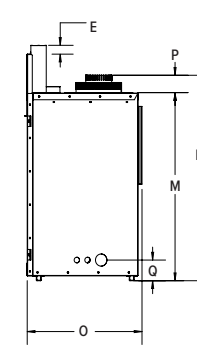

- A 66 <sup>3</sup>/<sub>16</sub>"
- B 61 <sup>1</sup>/<sub>8</sub>"
- C 39 <sup>9</sup>/<sub>16</sub>"
- D 38 <sup>5</sup>/<sub>16</sub>"
- E 1/2"
- F 3/4"
- G 19 <sup>15</sup>/<sub>16</sub>"
- H 9 <sup>9</sup>/<sub>16</sub>"
- I 8 <sup>13</sup>/<sub>16</sub>"
- J 53 <sup>3</sup>/<sub>8</sub>"
- K 19 <sup>3</sup>/<sub>8</sub>"
- L 11 <sup>9</sup>/<sub>16</sub>"
- M 33 <sup>1</sup>/<sub>16</sub>"
- N 35 <sup>3</sup>/<sub>4</sub>"
- O 18 <sup>3</sup>/<sub>4</sub>"
- P 2 <sup>1</sup>/<sub>16</sub>"
- Q 3 <sup>3</sup>/<sub>16</sub>"

TOP VIEW

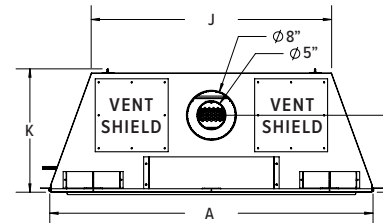

### FIREPLACE DIMENSIONS

Width	Height	Depth
66 <sup>3</sup> / <sub>16</sub> "	39 <sup>9</sup> / <sub>16</sub> "	19 <sup>3</sup> / <sub>8</sub> "

### FRAMING DIMENSIONS

Width	Height	Depth
67"	39 <sup>3</sup> / <sub>4</sub> "	19 <sup>1</sup> / <sub>4</sub> "

\*dependent of finishing material used.

## OPTIONAL WALL SURROUND

FRONT VIEW

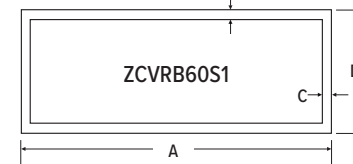

- A 64"
- B 1 1/2"
- C 1 1/2"
- D 23"
- E 3/4"

## OPTIONAL SIDE GRILL – VL60EGS

FRONT VIEW

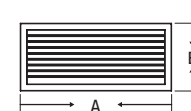

SIDE VIEW

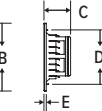

TOP VIEW



- A 16 <sup>3</sup>/<sub>16</sub>"
- B 7 <sup>7</sup>/<sub>8</sub>"
- C 2 <sup>7</sup>/<sub>8</sub>"
- D 6 <sup>7</sup>/<sub>16</sub>"
- E 1/4"
- F 15 <sup>7</sup>/<sub>16</sub>"
- G 2 <sup>9</sup>/<sub>16</sub>"

## OPTIONAL FRONT ENCLOSURE GRILL – VL60EG

FRONT VIEW

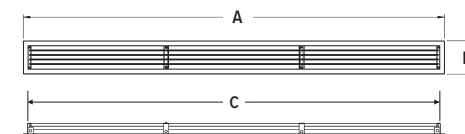

SIDE VIEW

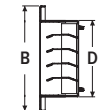

- A 61 <sup>3</sup>/<sub>4</sub>"
- B 4 <sup>7</sup>/<sub>8</sub>"
- C 60 <sup>1</sup>/<sub>2</sub>"
- D 3 1/2"



## SERENE 47 AND 60 ACCESSORY OPTIONS

### LOG SETS

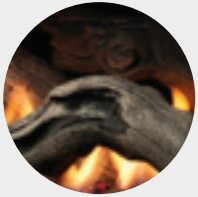

**MQ46D**  
3-Piece  
Driftwood Set



**MQRBD1**  
4-Piece  
Driftwood Set  
with 4 Rocks

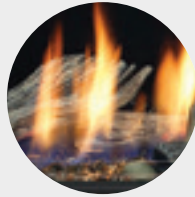

**MQRBD2**  
3-Piece  
Driftwood Set

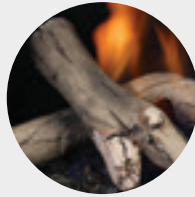

**MQRBD4 (3-Piece)**  
**MQRBD3 (5-Piece)**  
Driftwood Set

### LINERS



**Fluted**  
(ZCVRB47 Only)

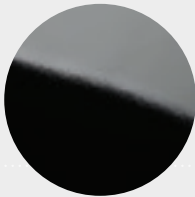

**Porcelain  
Reflective**

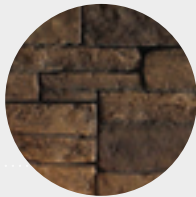

**Stacked Brick**  
(ZCVRB60 Only)

### WALL SURROUNDS



**Black**



**Stainless**

### MEDIA OPTIONS



**MQG5ZG**  
Zircon Glacier  
Ice Glass



**MQG5A**  
Cobalt  
Ember Glass



**MQG5B**  
Black  
Ember Glass

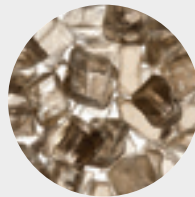

**MQG5C**  
Bronze  
Ember Glass



**MQG5W**  
White  
Ember Glass

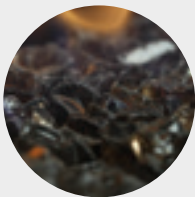

**MQEMBER**  
Ember  
Chunks



**MQSTONE**  
Decorative  
Stones



**MQROCK2**  
Natural  
Rock Set



**MQROCK3**  
Multi-Colored  
Rock Set



**RBCB1**  
Multi-Colored  
Cannonballs

## VENTED CHASE OPTION

The chase of the appliance may be vented to achieve Cool Touch Walls or reduced Mantel Clearances. The following options are available to vent the chase:

- The top of the chase can be left open.
- A grill can be installed on the front of the chase.
- If the chase bumps out into the room, side grills can be installed on each side of the chase.

See illustrations and manual for further information.

Minimum enclosure height for a vented chase is measured from bottom of fireplace, ventilation of minimum free air opening is required. Choose between our Enclosure Grills (Front or Sides) or Custom Grill (if custom grills are used the louvers cannot slope) or adequate ventilation opening as stated in the manual. Grill or opening must meet minimum (as specified in the installation manual) of chase top/ceiling.

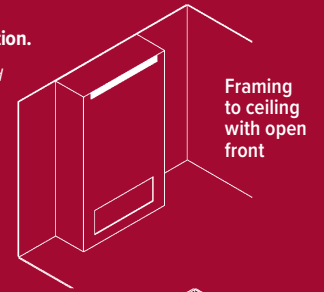

Framing to ceiling with open front

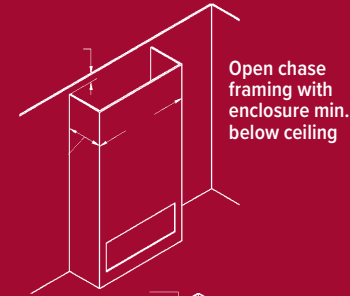

Open chase framing with enclosure min. below ceiling

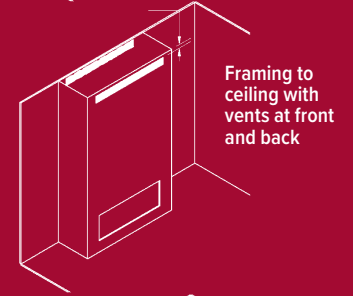

Framing to ceiling with vents at front and back

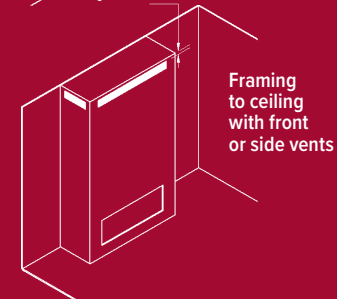

Framing to ceiling with front or side vents

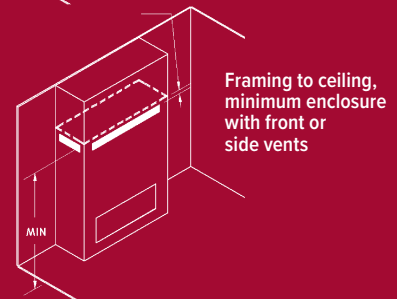

Framing to ceiling, minimum enclosure with front or side vents

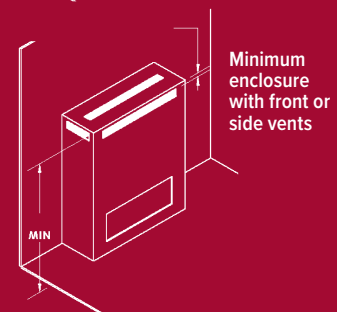

Minimum enclosure with front or side vents

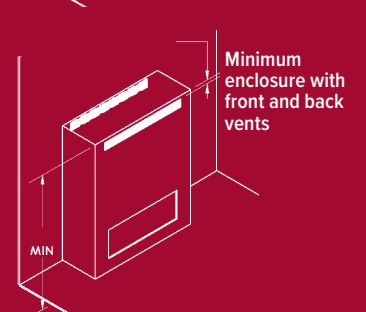

Minimum enclosure with front and back vents

NOTE: To vent the fireplace chase, removal of vent shields from the fireplace is required.



Unit Illustrated: ZCVRB60N Zero Clearance Direct Vent Gas Fireplace (Natural Gas), ZCVRB60S1SS Surround Stainless Steel, MQEMBER Ember Chunks, MQRBD3 Driftwood Log Set, MQVL60RLSB Liner (Stacked Brick).



Marquis Fireplaces maintains a program of continuous testing, refinement and improvements of all its products. Some aspect of units shown here may be changed at any time without notice or obligation.

Certification: Models ZCVRB47/60 are certified to ANSI Z21.88-2017, vented gas fireplace heater.

Note: Components may have to be ordered separately to create a complete unit. Discuss with your local Marquis Dealer for clarification.



**FOR CALIFORNIA RESIDENTS ONLY:**  
**WARNING!** This product can expose you to chemicals including Carbon Monoxide, that is an externally vented by-product of fuel consumption, which is [are] known to the State of California to cause birth defects or other reproductive harm. For more information, visit [www.P65Warnings.ca.gov](http://www.P65Warnings.ca.gov).

Crafted entirely in Canada, each Marquis fireplace is built to the highest standards and made to last.



LIMITED LIFETIME WARRANTY

2340 Logan Avenue  
Winnipeg, Manitoba, CAN  
R2R 2V3  
Phone: 204.632.1962  
Fax: 204.632.1960  
[marquisfireplaces.net](http://marquisfireplaces.net)

Printed in Canada  
B104 - 09/19

Canada

**ENERGUIDE**

Look for the **EnerGuide**  
Gas Fireplace Energy  
Efficiency Rating in this brochure

Based on CSA P.4.1-15