



Unit Illustrated: ZCVRB60NE Zero Clearance Direct Vent Gas Fireplace (Natural Gas), MOSTONE Decorative Stones, ZCVRB60PL Porcelain Liners, shown with Vented Chase Option – VL60EG Front Enclose Grill.

SERENE

ZERO CLEARANCE DIRECT VENT GAS FIREPLACE

 marquis
COLLECTION

SERENE 47 / 60 / 72

A FEELING OF SERENITY.

At the end of a busy day, cozy up to the new **SERENE** by Marquis. With beautiful designer details and the highest quality craftsmanship, Serene combines pure comfort with a wow factor that comes from your choice of rocks and driftwood, decorative stones, cannonballs or ember glass. Relax and unwind the Serene way.

Visit www.marquisfireplaces.net to see the latest evolution in fireplaces.

Find all detailed Serene manuals:



STANDARD FEATURES

- Hi/Low Millivolt or IPI valve system will operate during power failures
- Bronze Glass
- Mobile Home, Bedroom and Bed Sitting Room approved
- Proflame II Models include remote control – features flame, fan, thermostat, smart thermostat (WIFI Compatible*) and LED lights (non-dimmable)
- Safety Screen Barrier

OPTIONAL FEATURES

Surround: Black or Stainless Steel

Fan Kit: Heat activated with variable speed control

Universal Light Kit (MV/IPI PF1): Two Lamps (accent lighting)

Wall Mount Thermostat: Standard on/off or Programmable 5 day (weekday) and 2 day (weekend)

Log Sets: Three Piece Driftwood Set (MQ46D), Four Piece Driftwood with Four Rocks (MQRBD1), Three Piece Driftwood Log Set (MQRBD4), Five Piece Driftwood Set (MQRBD3), or Five Piece Birch Log Set (MQRBRW)

Media Options: Contemporary Rocks, Decorative Stones, Decorative Ember Glass (Glacier Ice, Cobalt Blue, Black, Bronze, White), Ember Chunks or Multi-Colored Cannonballs

Liners: Porcelain Reflective, Fluted Brick (Serene 47), or Stacked Stone (Serene 60/72)

Remote Controls: Thermostat on/off, Thermostat on/off modulating, Thermostat on/off modulating, fan control and lights

*Enclosure Grill Opening:

Model	Front Width	Front Height	Side Width	Side Height
SERENE 47	46 ¾"	2 ⅝"	15 ¼"	6 ⅝"
SERENE 60	60 ⅝"	3 ⅝"	15 ¼"	6 ⅝"
SERENE 72	78 ⅝"	3 ⅝"	15 ¼"	9"

*When appliance is installed using vented chase technology.



* Smartphone (local WIFI only)



SERENE 47

SERENE 47 PRODUCT SPECIFICATIONS

MODEL	ZCVRB47N/NE MQZCVRB47NE2	ZCVRB47LP/LPE MQZCVRB47LPE2
Fuel	Natural	Propane
Gas Control	Millivolt / IPI	Millivolt / IPI
Input Max.	24,500 BTU	24,500 BTU
Input Min.	16,500 BTU	20,500 BTU
FE (P.4.1-15)	55.26% / 57.31%	55.01% / 57.10%
Glass Size	40 5/8"W x 13 7/8"H	40 5/8"W x 13 7/8"H
Venting	4"/7" Flex or 4" x 6 5/8" Hard Pipe	4"/7" Flex or 4" x 6 5/8" Hard Pipe



Unit Illustrated: MQZCVRB47NE2 Zero Clearance Direct Vent Gas Fireplace (Natural Gas), ZCVRB47S1SS Surround Stainless Steel, MORBRW Birch Log Set, ZCVRB47PL Porcelain Liners, and MQSTONE10 Decorative Stones.

VENTED CHASE OPTION

SERENE 47

WITH OPENINGS (NO GRILLS)

Min. Enclosure Height

Min. 105 sq/in.

70"

Min. Opening Below Ceiling

1-1/4"

WITH GRILLS (MIN. AIR FREE OPENINGS)

105 sq/in.

Min. Enclosure Height

70"

Grill Opening (Max. distance from top of enclosure)

2"

Unit Illustrated: ZCVRB47NE Zero Clearance Direct Vent Gas Fireplace (Natural Gas), MQZCVRB47RLF Fluted Liner, shown as a Vented Chase (top of chase is open).



SERENE 47 PRODUCT DIMENSIONS

FRONT VIEW

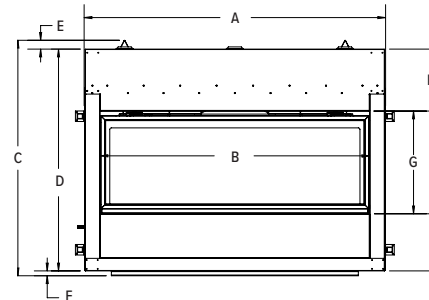

SIDE VIEW

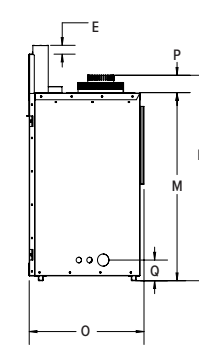

- A 46 5/8"
- B 41 5/8"
- C 38 5/8"
- D 35 1/16"
- E 2 1/4"
- F 3/4"
- G 15 7/8"
- H 11"
- I 8 13/16"
- J 34 5/8"
- K 17 3/4"
- L 11 1/16"
- M 29 1/16"
- N 31 1/16"
- O 17 3/4"
- P 2 1/16"
- Q 3 3/16"

TOP VIEW

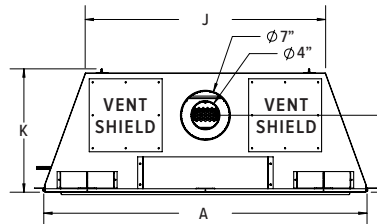

FIREPLACE DIMENSIONS

Width Height Depth
46 5/8" 38 5/8" 17 3/4"

FRAMING DIMENSIONS

Width Height Depth
47" 38 3/4" 18 1/4"

*dependent of finishing material used.

OPTIONAL WALL SURROUND

FRONT VIEW

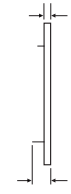
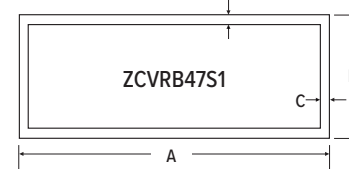

- A 44 5/8"
- B 1 1/2"
- C 1 1/2"
- D 17 3/4"
- E 1"
- F 1 3/4"

SIDE

OPTIONAL SIDE GRILL - VL60EGS

FRONT VIEW

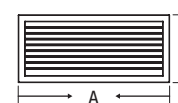

SIDE VIEW

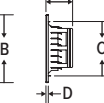

TOP VIEW



- A 16 3/16"
- B 7 7/8"
- C 6 7/16"
- D 1/4"
- E 15 7/16"
- F 2 9/16"

OPTIONAL FRONT ENCLOSURE GRILL - V46EG

FRONT VIEW

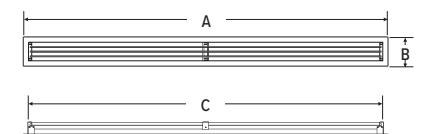

SIDE VIEW

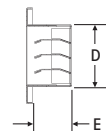

- A 47 13/16"
- B 3 13/16"
- C 46 9/16"
- D 2 1/2"
- E 1 9/16"

SERENE 60

SERENE 60 PRODUCT SPECIFICATIONS

MODEL	ZCVRB60N ZCVRB60NE MQZCVRB60NE2	ZCVRB60LP ZCVRB60LPE MQZCVRB60LPE2
Fuel	Natural	Propane
Gas Control	Millivolt / IPI	Millivolt / IPI
Input Max.	35,000 BTU	35,000 BTU
Input Min.	23,000 BTU	28,000 BTU
FE (P.4.1-15)	55.27%/56.66%	55.27%/56.66%
Glass Size	60"W x 17 7/8"H	60"W x 17 7/8"H
Venting	5"/8"	5"/8"



Unit Illustrated: MQZCVRB60NE2 Zero Clearance Direct Vent Gas Fireplace (Natural Gas), ZCVRB60S1BL Surround (Black), MQ46D Driftwood Log Set, MQSTONE10 Decorative Stones, MQRB60RLS Liner (Stacked Brick), shown as a Vented Chase (top of chase is open).

VENTED CHASE OPTION

WITH OPENINGS (NO GRILLS)

Min. Enclosure Height
Min. Opening Below Ceiling

WITH GRILLS (MIN. AIR FREE OPENINGS)

Min. Enclosure Height
Grill Opening (Max. distance from top of enclosure)

SERENE 60

Min. 200 sq/in.

76"
1-7/8"

220 sq/in.

76"
3/4"



ZCVRB60NE Zero Clearance Direct Vent Gas Fireplace (Natural Gas), MQG5W Glass Media (White x2), ZCVRB60PL Porcelain Liners.



ZCVRB60NE Zero Clearance Direct Vent Gas Fireplace (Natural Gas), RBCB1 Cannonballs, ZCVRB60PL Porcelain Liners.

Unit Illustrated: MQZCVRB60NE2 Zero Clearance Direct Vent Linear Gas Fireplace (Natural Gas), MOROCK3 Multi-Colored Rock Set, ZCVRB60PL Porcelain Liners, shown as a Vented Chase with Optional VL60EG – Front Enclosure Grill.



SERENE 60 PRODUCT DIMENSIONS

FRONT VIEW

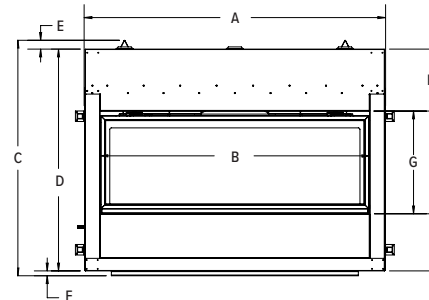

SIDE VIEW

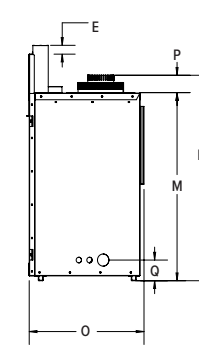

- A 66 3/16"
- B 61 1/8"
- C 39 9/16"
- D 38 5/16"
- E 1/2"
- F 3/4"
- G 19 15/16"
- H 9 9/16"
- I 8 13/16"
- J 53 3/8"
- K 19 3/8"
- L 11 9/16"
- M 33 1/16"
- N 35 3/4"
- O 18 3/4"
- P 2 11/16"
- Q 3 3/16"

TOP VIEW

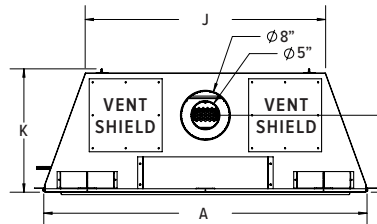

FIREPLACE DIMENSIONS

Width	Height	Depth
66 3/16"	39 9/16"	19 3/8"

FRAMING DIMENSIONS

Width	Height	Depth
67"	39 3/4"	19 1/4"

**dependent of finishing material used.*

OPTIONAL WALL SURROUND

FRONT VIEW

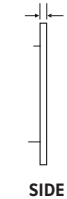
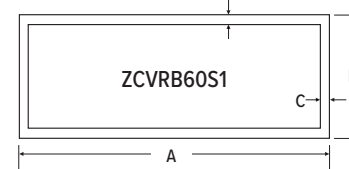

- A 64"
- B 1 1/2"
- C 1 1/2"
- D 23"
- E 3/4"

OPTIONAL SIDE GRILL – VL60EGS

FRONT VIEW

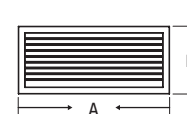

SIDE VIEW

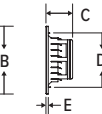

TOP VIEW

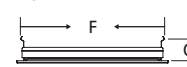

- A 16 3/16"
- B 7 7/8"
- C 2 7/8"
- D 6 7/16"
- E 1/4"
- F 15 7/16"
- G 2 9/16"

OPTIONAL FRONT ENCLOSURE GRILL – VL60EG

FRONT VIEW

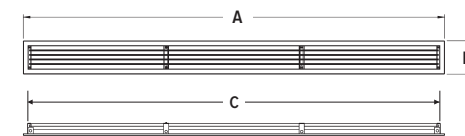

SIDE VIEW

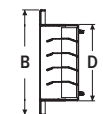

- A 61 3/4"
- B 4 7/8"
- C 60 1/2"
- D 3 1/2"

SERENE 72

SERENE 72 PRODUCT SPECIFICATIONS

MODEL	ZCVRB72N	ZCVRB72LP	ZCVRB72NE MQZCVRB72NE2	ZCVRB72LPE MQZCVRB72LPE2
Fuel	Natural	Propane	Natural	Propane
Gas Control	Millivolt	Millivolt	IPI	IPI
Input Max.	50,000 BTU	50,000 BTU	50,000 BTU	50,000 BTU
Input Min.	34,000 BTU	39,000 BTU	34,000 BTU	39,000 BTU
FE (P.4.1-15)	53.14%	53.14%	53.64%	53.64%
Glass Size	73 1/32"W x 17 7/8"H	73 1/32"W x 17 7/8"H	73 1/32"W x 17 7/8"H	73 1/32"W x 17 7/8"H
Venting	5"/8"	5"/8"	5"/8"	5"/8"



Unit Illustrated: ZCVRB72NE Zero Clearance Direct Vent Gas Fireplace (Natural Gas), MQVL72RLF2 Fluted Liner - Back, MQVL60RLF2 Fluted Liner - Ends, MQRBRW Birch Wood Logs (x2), and VL72EG Grill (shown as a Vented Chase)

SERENE 72



Unit Illustrated: MQZCVRB72NE2 Zero Clearance Direct Vent Gas Fireplace (Natural Gas), ZCVRB72S1BL Surround (Black), MQVL72RGB - Reflective Glass Liner - Back, MQVL72RGE Reflective Glass Liner - Ends, and VL72EGS Grill (shown as a vented chase)

VENTED CHASE OPTION

WITH OPENINGS (NO GRILLS)

Min. Enclosure Height

Min. Opening Below Ceiling

WITH GRILLS (MIN. AIR FREE OPENINGS)

Min. Enclosure Height

Grill Opening (Max. distance from top of enclosure)

SERENE 72

Min. 285 sq/in.

79"

2-³/₈"

285 sq/in.

79"

³/₄"

SERENE 72 PRODUCT DIMENSIONS

FRONT VIEW

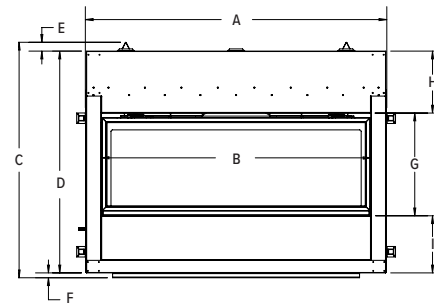

SIDE VIEW

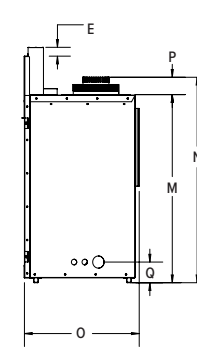

TOP VIEW

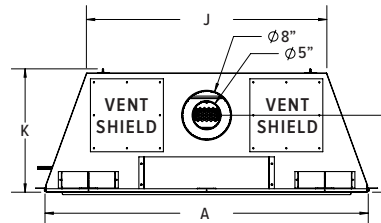

- A 78 ³/₄"
- B 73 ⁷/₈"
- C 42"
- D 40"
- E 1 ¹/₂"
- F ³/₄"
- G 20"
- H 11 ¹⁵/₁₆"
- I 7 ¹/₄"
- J 71 ³/₄"
- K 19 ³/₈"
- L 12 ¹/₄"
- M 34 ¹/₈"
- N 40 ⁵/₁₆"
- O 19 ³/₈"
- P 4 ³/₄"
- Q 3 ³/₁₆"

FIREPLACE DIMENSIONS

Width	Height	Depth
78 ³ / ₄ "	42"	19 ³ / ₈ "

FRAMING DIMENSIONS

Width	Height	Depth
79 ¹ / ₈ "	42"	19"

**dependent of finishing material used.*



ZCVRB72NE Zero Clearance Direct Vent Gas Fireplace (Natural Gas), RBCB1 Cannonballs, ZCVRB72PL Porcelain Liners.



ZCVRB72NE Zero Clearance Direct Vent Gas Fireplace (Natural Gas), MQG5W Glass Media (White) x3, MQSTONE Rock Media (Decorative Stones), ZCVRB72PL Porcelain Liners.

OPTIONAL WALL SURROUND - (BLACK OR STAINLESS)

FRONT VIEW

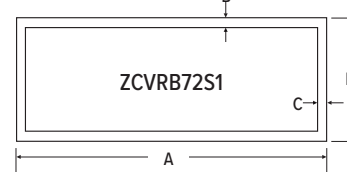

- A 76 ³/₄"
- B 1 ¹/₂"
- C 1 ¹/₂"
- D 23"
- E ³/₄"

SIDE

OPTIONAL SIDE GRILL - VL72EGS

FRONT VIEW

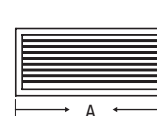

SIDE VIEW

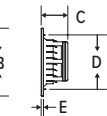

TOP VIEW

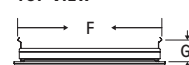

- A 16 ³/₁₆"
- B 10 ³/₈"
- C 2 ⁷/₈"
- D 8 ¹⁵/₁₆"
- E ¹/₄"
- F 15 ⁷/₁₆"
- G 2 ⁹/₁₆"

OPTIONAL FRONT ENCLOSURE GRILL - VL72EG

FRONT VIEW

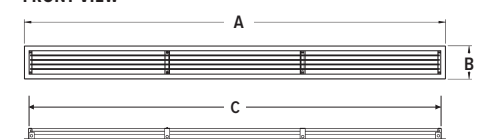

SIDE VIEW

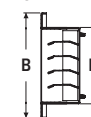

- A 79 ³/₄"
- B 4 ⁷/₈"
- C 78 ¹/₂"
- D 3 ¹/₂"

ACCESSORIES

LOG SETS



MQ46D – Driftwood



MQRBD1 – Driftwood with Rocks



MQRBD2 – Driftwood



MQRBD3/MQRBD4 – Driftwood



MQRBRW – Birchwood

MEDIA OPTIONS*



MQG5ZG – Zircon Glacier Ice Glass



MQG5A – Cobalt Ember Glass



MQG5B – Black Ember Glass



MQG5C – Bronze Ember Glass



MQG5W – White Ember Glass



MQEMBER – Ember Chunks



MQSTONE – Decorative Stones



MQROCK2 – Natural Rocks



MQROCK3 – Multi-Colored Rocks



RBCB1 – Multi-Colored Cannonballs

LINERS

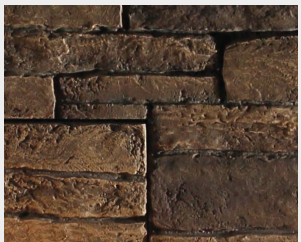

RLS – Stacked Brick
SERENE 60 / 72

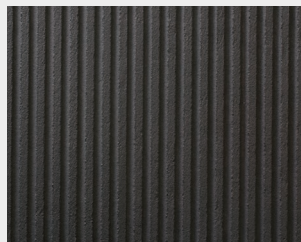

RLF – Fluted
SERENE 47 / 72



PL – Porcelain Reflective
SERENE 47 / 60 / 72

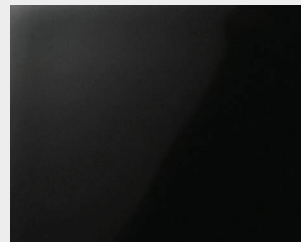

RG - Reflective Glass
SERENE 72

WALL SURROUNDS

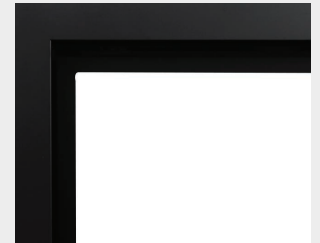

Black



Stainless Steel

**Glass Tray Required*

VENTED CHASE OPTION

The chase of the appliance may be vented to achieve Cool Touch Walls or reduced Mantel Clearances.

The following options are available to vent the chase:

- The top of the chase can be left open.
- A grill can be installed on the front of the chase.
- If the chase bumps out into the room, side grills can be installed on each side of the chase.

See illustrations and manual for further information.

Minimum enclosure height for a vented chase is measured from bottom of fireplace, ventilation of minimum free air opening is required. Choose between our Enclosure Grills (Front or Sides) for adequate ventilation opening as stated in the manual. Grill or opening must meet minimum (as specified in the installation manual) of chase top/ceiling.

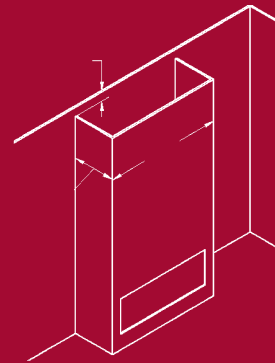

Open chase framing with enclosure min. below ceiling



Framing to ceiling with open front

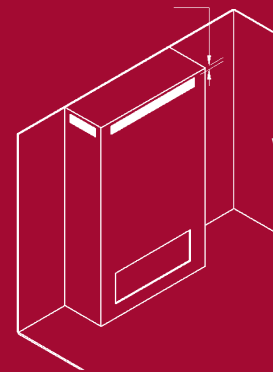

Framing to ceiling with front or side vents

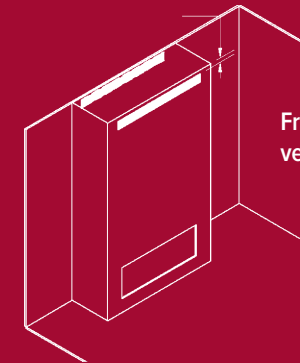

Framing to ceiling with vents at front and back

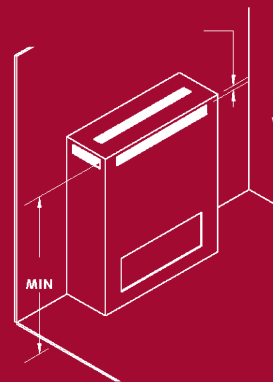

Minimum enclosure with front or side vents



Framing to ceiling, minimum enclosure with front or side vents

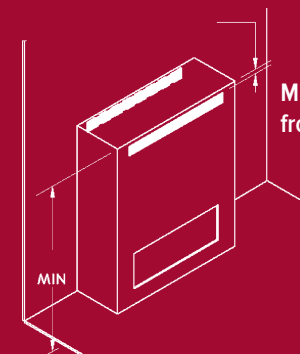

Minimum enclosure with front and back vents

NOTE: To vent the fireplace chase, removal of vent shields from the fireplace is required.



Unit Illustrated: ZCVRB60NE Zero Clearance Direct Vent Gas Fireplace (Natural Gas), ZCVRB60S1SS Surround Stainless Steel, MQEMBER Ember Chunks, MQRBD3 Driftwood Log Set, MQVL60RLSB Liner (Stacked Brick).



Marquis Fireplaces maintains a program of continuous testing, refinement and improvements of all its products. Some aspect of units shown here may be changed at any time without notice or obligation.

Certification: Certified to ANSI Z21.88-19, CSA 2.33-19, CSA 2.17-2017 Vented Gas Fireplace Heaters.

Note: Components may have to be ordered separately to create a complete unit. Discuss with your local Marquis Dealer for clarification.

Canada

ENERGUIDE

Look for the **EnerGuide** Gas Fireplace Energy Efficiency Rating in this brochure

Based on CSA P.4.1-15



FOR CALIFORNIA RESIDENTS ONLY:
WARNING! This product can expose you to chemicals including Carbon Monoxide, that is an externally vented by-product of fuel consumption, which is [are] known to the State of California to cause birth defects or other reproductive harm. For more information, visit www.P65Warnings.ca.gov.

Crafted entirely in Canada, each Marquis fireplace is built to the highest standards and made to last.

LIMITED LIFETIME WARRANTY



2340 Logan Avenue
Winnipeg, Manitoba, CAN
R2R 2V3
Phone: 204.632.1962
Fax: 204.632.1960
marquisfireplaces.net

Printed in Canada
B104 - 01/2024