

Installation & Maintenance Manual

MONTIGO[®]
the art of **fireplaces**

DelRay INDOOR DIRECT VENT GAS FIREPLACE

DRL3613NI 16,000 BTU/hr Natural Gas or Propane Gas

DRL3613NI-2 16,000 BTU/hr Natural Gas or Propane Gas

DRL4813NI 21,000 BTU NG /19,000 BTU Propane /hr

DRL4813NI-2 21,000 BTU NG /19,000 BTU Propane /hr

DRL6013NI 28,000 BTU NG /25,000 BTU Propane /hr

DRL6013NI-2 28,000 BTU NG /25,000 BTU Propane /hr

DRL7213NI 35,500 BTU NG /32,000 BTU Propane /hr

DRL7213NI-2 35,500 BTU NG /32,000 BTU Propane /hr



IMPORTANT

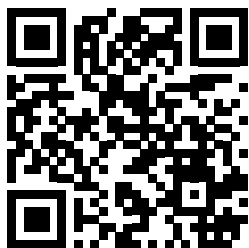

SCAN THE QR CODE OR VISIT THE WEBSITE TO VIEW THE MOST RECENT VERSION OF THE MANUAL

WWW.MONTIGO.COM/PRODUCT-GUIDES



CAUTION

Installation and service must be performed by a qualified installer, service agency or the gas fitter. Check local codes and read all instructions prior to installation.

WARNING:
FIRE OR EXPLOSION HAZARD
Failure to follow safety warnings exactly could result in serious injury, death, or property damage.

- Do not store or use gasoline or other flammable vapors and liquids in the vicinity of this or any other appliance.
- WHAT TO DO IF YOU SMELL GAS
 - Do not try to light any appliance.
 - Do not touch any electrical switch; do not use any phone in your building.
 - Leave the building immediately.
 - Immediately call your gas supplier from a neighbour's phone. Follow the gas supplier's instructions.
 - If you cannot reach your gas supplier, call the fire department.
- Installation and service must be performed by a qualified installer, service agency or the gas fitter.

Canada

ENERGUIDE

Look for the **EnerGuide**
Gas Fireplace Energy
Efficiency Rating in this brochure

Based on CSA P.4.1-15



DANGER



**HOT GLASS WILL CAUSE BURNS.
DO NOT TOUCH GLASS UNTIL
COOLED.**

**NEVER ALLOW CHILDREN
TO TOUCH GLASS.**

A barrier designed to reduce the risk of burns from the hot viewing glass is provided with this appliance and must be installed for the protection of children and other at-risk individuals.

NOTICE

Installer: Leave this manual with the appliance. Please refer to the Montigo website for the most current version of the fireplace manual
Consumer: Retain this manual for future reference. Please refer to the Montigo website for the most current version of the fireplace manual

WARNING

Some materials used in the manufacturing process of this product can expose you to Benzene which is known in the State of California to cause cancer and birth defects or other reproductive harm. For more information go to www.P65warnings.ca.gov

Safety Alert Key

DANGER

Indicates a hazardous situation which, if not avoided, WILL result in death or serious injury or property damage.

WARNING

Indicates a hazardous situation which, if not avoided, COULD result in death or serious injury or property damage.

CAUTION

Indicates a hazardous situation which, if not avoided, WILL result in minor or moderate injury.

NOTICE

Indicates practices that are important, but not related to personal injury.

Introduction

Congratulations on your purchase of a Montigo Fireplace.

With over 30 years of experience, Montigo is committed to providing you with a gas fireplace that is not only a beautiful addition to your space, but that is also designed and manufactured to the highest safety, reliability and engineering standards.

We strongly encourage you to read and carefully follow the instructions laid out in this Installation, Operation and Maintenance Manual and retain it for your future reference. Pay special attention to all cautions, warnings, and notices throughout this manual intended to ensure your safety.

This manual covers installation, operation and maintenance. Lighting, operation and care of this fireplace can be easily performed by the homeowner. All installation and service work should be performed by a qualified or licensed installer, plumber or gas fitter as certified by the state, province, region or governing body where the fireplace is being installed.

This installation, operation and maintenance manual is applicable to the models described in Table 1. Refer to your rating plate to verify included options.

Warranty and Installation Information: (See Appendix B)

The Montigo warranty will be voided by, and Montigo disclaims any responsibility for, the following actions:

- Modification of the fireplace and/or components including Direct-Vent assembly or glass doors.
- Use of any component part not manufactured or approved by Montigo in combination with this Montigo fireplace system.
- Installation other than as instructed in this manual.
- Consult your local Gas Inspection Branch on installation requirements for factory-built gas fireplaces. Installation & repairs should be done by a qualified contractor.

BTU Listing							
MODEL	Natural Gas	Liquid Propane	BTU / hr	Linear Burner w/ Glass Accessories	SIT Elect. Ignition	SIT Elect. Ignition BASIC	P.4. 1-15 Efficiency*
DRL3613NI	X		16,000	X		X	71
DRL3613LI		X	16,000	X		X	71
DRL3613NI-2	X		16,000	X	X		71
DRL3613LI-2		X	16,000	X	X		71
DRL4813NI	X		21,000	X		X	63
DRL4813LI		X	19,000	X		X	60
DRL4813NI-2	X		21,000	X	X		63
DRL4813LI-2		X	19,000	X	X		60
DRL6013NI	X		28,000	X		X	67
DRL6013LI		X	25,000	X		X	66
DRL6013NI-2	X		28,000	X	X		64
DRL6013LI-2		X	25,000	X	X		64
DRL7213NI	X		35,500	X		X	66
DRL7213LI		X	32,000	X		X	67
DRL7213NI-2	X		35,500	X	X		64
DRL7213LI-2		X	32,000	X	X		66

Figure 1 DRL Specifications

CAUTION

Young children should be carefully supervised when they are in the same room as the appliance. Toddlers, young children, and others may be susceptible to accidental contact burns. A physical barrier is recommended if there are at-risk individuals in the house. To restrict access to a fireplace or stove, install an adjustable safety gate to keep toddlers, young children, and other at-risk individuals out of the room and away from hot surfaces

This appliance may be installed in an aftermarket, permanently located, manufactured home (USA only) or mobile home, where not prohibited by local codes.

This appliance is only for use with the type of gas indicated on the rating plate. A conversion kit is available for this appliance.

Contents

Safety Alert Key	2	Section 8: Removing & Installing the Screen / Door	40
Introduction	2	Removing the Screen	40
Section A: Before You Begin	5	Reinstalling the Screen	40
Installation Checklist.....	5	Removing the door	40
Standard Installation Checklist	6	Reinstalling the door	40
Rating Plate Sample.....	7	Propane Conversion (High-Low Burner)	41
Section 1: Dimensions	9	Propane Conversion (Ribbon Burner)	44
DelRay 36, 48 Dimensions	9	Section 9: Installing the Accessories	46
DelRay 60, 72 Dimensions	10	Installing the Fireglass or Optional Glass Media	46
LVP and delicate flooring.....	11	DelRay 36" Optional Log Kit Installation	46
Recommended floor recess considerations	11	Driftwood Layout.....	46
Section 2: Framing	12	DelRay 48" Optional Log Kit Installation	47
Framing Dimensions 36", 48".....	12	Driftwood Layout.....	47
Framing Dimensions 60", 72".....	13	DelRay 60" Optional Log Kit Installation	48
Clearances	14	Driftwood Layout.....	48
Clearance to Sprinkler.....	14	DelRay 72" Optional Log Kit Installation	49
Header on edge clarification	15	Driftwood Layout.....	49
36, 48 Standard installation.....	16	Remote Operation (Full Load Units)	50
36, 48 Standard installation (Shelf over)	16	Initializing the System for the first time.....	51
36, 48 Vented installation (Cool Wall Release).....	17	Operating the System for the first time.....	51
60, 72 Standard installation.....	18	Temperature Indication Display	51
60, 72 Standard installation (Shelf over)	18	Turn On the Fireplace	51
Vented installation (Cool Wall Release).....	19	Turn Off the Fireplace	51
Full load Versions:.....	20	Remote-Flame Control.....	51
Disable fans via remote	20	Room Thermostat (Remote Control Operation).....	52
Basic Versions (if optional fan kit already installed):	20	Smart Thermostat (Remote Control Operation)	52
Disable fans via harness	20	Disabling Thermostat	52
Section 3: Venting	20	Fan Speed Control	52
Section 3-3-1: Venting Layout	21	Accent Light Control.....	52
DRL36 & DRL48 Venting -	21	Pairing Issues	53
Wall and roof termination	21	Solution:	53
DRL60 Venting -	22	Disabling functions (Wi-Fi).....	53
Wall and roof termination.....	22	Section 10: Cleaning and Maintenance	55
DRL72 Venting -	23	General	55
Wall and roof termination.....	23	Cleaning.....	55
Co-linear venting into existing masonry chimney.....	24	Pilot Burner Adjustment.....	55
Section 3-2: Installing a Roof Vent Termination	25	POD - Pilot on Demand	56
Section 3-2-1: Roof Venting termination.....	25	What is POD mode?.....	56
Section 3-3: Installing a Wall Mounted Termination	26	Remote Continuous Pilot (CPI) Selection	56
Section 3-3-2: Venting Components	27	Installing the POD Jumper Cable.....	56
4/7 Venting components.....	28	Troubleshooting	57
5/8 Venting components.....	28	Indoor fireplace in protected outdoor applications	58
Section 3-3-2.2: 4" x 7" Alternate Venting Components.....	29	See through fireplace	58
Section 3-3-2.2: Alternate Venting Components 5"/8"	30	Notes	58
Flexmaster as alternate venting	31	Single sided fireplace	58
Section 3-3-3: Heat Shields 4"/7"	32	Appendix A: Venting Terminations	59
Section 3-3-4: Heat Shields 5"/8"	33	Appendix B: Warranty	60
Section 4: Wiring	34	Appendix B: Warranty Continued	61
DRL**13 (N/L) I Wiring Diagram.....	34	Appendix C: Amendment	62
Installation of the wall switch	34	(Gas Fireplace / Equipment sold in the State of Massachusetts)	62
DRL**13 (N/L) I-2 Wiring Diagram.....	35	DRL3613*I BASIC Exploded Parts	63
Installation of Electrical Supply	35	DRL3613*I-2 FULL LOAD Exploded Parts	64
Section 5: Installing the gas line	36	DRL4813*I BASIC Exploded Parts	65
Fuel Type	36	DRL4813*I-2 FULL LOAD Exploded Parts	66
Gas Pressure.....	36	DRL6013*I BASIC Exploded Parts	67
Section 5-3: GAS CONNECTION.....	36	DRL6013*I-2 FULL LOAD Exploded Parts	68
Finishing Safety Zone	36	DRL7213*I BASIC Exploded Parts	69
Section 6: Finishing	37	DRL7213*I-2 FULL LOAD Exploded Parts	70
Finishing Around the Fireplace	37		
Finishing when using a Cool Wall Advantage kit or vented chase (Cool Wall Release).....	37		
Chase venting (optional).....	38		
Sidewall clearances.....	38		
Cement Board Install.....	39		
Full load Versions:.....	39		
Disable fans via remote	39		
Basic Versions (if optional fan kit already installed):	39		
Disable fans via harness	39		

Section A: Before You Begin

IMPORTANT MESSAGE: SAVE THESE INSTRUCTIONS

DelRay fireplaces must be installed in accordance with these instructions. Carefully read all the instructions in this manual first. Consult the Local Gas Branch to determine the need for a permit prior to starting the installation. It is the responsibility of the installer to ensure this fireplace is installed in compliance with the manufacturers instructions and all applicable codes.

NOTICE

Do not use this appliance if any part has been under water. Immediately call a qualified service technician to inspect the appliance and to replace any part of the control system and any gas control that has been under water

NOTICE

Due to high temperatures, the appliance should be located out of traffic and away from furniture and draperies

NOTICE

Children and adults should be alerted to the hazards of high surface temperature and should stay away to avoid burns or clothing ignition

NOTICE

A barrier designed to reduce the risk of burns from the hot viewing glass is provided with this appliance and shall be installed for the protection of children and other at-risk individuals

This appliance may be installed as an OEM installation in a manufactured home(USA only) or mobile home and must be installed in accordance with the manufacturers instructions and the *Manufactured Home Construction and Safety Standard, Title 24 CFR, Part 3280, in the United States, or the Standard for Installation in Mobile Homes, CAN/CSA Z240 MH, in Canada.*

This appliance is only for use with the type(s) of gas indicated on the rating plate. A conversion kit is available for this appliance.

Installation Checklist

- Determine the desired install location of your fireplace.
- See Section 1, Dimensions on Page 6, and refer to the Framing Section 2 for details.
- Select the location of your termination and resulting vent run.
- Should it be impossible to meet the venting requirements laid out in Section 3: Venting, please contact your Montigo dealer regarding the use of a Montigo Power Vent.
- Lay out the Vent run; calculating the required elbows and straight runs of 4"/7" flex and/or rigid pipe.
- Layout Electrical Requirements refer to Section 4: Wiring, for Details.
- Refer to Section 5: Installing the Gas Line, for details on the gas connection and access.
- Refer to local codes and guidelines for installation requirements.
- Installation and repairs should be done by a qualified contractor and must conform to:
- Installations in Canada must conform to the local codes or in the absence of local codes to the current version of Natural Gas and Propane Installation Code, CSA B149. Electrical installations must conform to the local codes or, in the absence of local codes, to the current version of Canadian Electrical Code, CSA C22.1.1
- Installations in the USA must conform to the local codes or in the absence of local codes to the current version of National Fuel Gas Code, ANSI Z223.1/NFPA 54. Electrical installations must conform to the local codes or, in the absence of local codes, to the current version of the National Electrical Code, ANSI/NFPA 70. See Appendix C for installation within the State of Massachusetts

NOTICE

Clothing or other flammable material should not be placed on or near the appliance

NOTICE

Installation and repair should be done by a qualified service person. The appliance should be inspected before use and at least annually by a professional service person. More frequent cleaning might be required due to excessive lint from carpeting, bedding material, etc. It is imperative that control compartments, burners, and circulating air passageways of the appliance be kept clean

Standard Installation Checklist



This standard installation checklist is to be used by the installer in conjunction with, not instead of, the instructions contained within this installation manual.

Customer _____	Date Installed: _____
Install Address: _____	Location of Fireplace: _____
Model(circle one): DRL3613NI, DRL3613NI-2, DRL4813NI, DRL4813NI-2	Installer: _____
DRL3613LI, DRL3613LI-2, DRL4813LI, DRL4813LI-2, DRL6013LI, DRL6013LI-2, DRL6013LI, DRL6013LI-2, DRL7213LI, DRL7213LI-2, DRL7213LI, DRL7213LI-2	Dealer Phone: _____
	Serial #: _____

	YES	NO	IF NO, WHY NOT?
Appliance Install: Section 2			
Framing complies with install manual.			
Standoffs have been installed.			
Proper clearances have been maintained.			
Venting: Section 3			
Venting configuration complies with vent diagrams.			
Venting installed, fastened, and secured in place maintaining proper clearance.			
Firestops installed.			
Exterior wall/roof flashing installed and sealed in compliance with local building code.			
Terminations installed and sealed in compliance with local building code.			
Direct vent termination is highest point in vent assembly.			
Wiring/Electrical: Section 4			
Unswitched power provided to the appliance PPO box.			
Low voltage wire connected to dry contact wall switch (non-powered)*			
Gas: Section 5			
Proper appliance for fuel type.			
Was a conversion performed?			
Leak check performed & inlet pressure verified.			
Finishing: Section 6			
Only non-combustible materials installed in non-combustible areas.			
Clearances meet installation manual requirements			
Mantels and/or projections comply with install manual			
Appliance Setup: Section 7 through 9			
Media, door, and screen installed according to install manual			
Manual given to home owner.			
Started appliance and verified no gas leaks exist.			
Comments:			

*Only applicable for Builders Series

Rating Plate Sample

US

Do Not Remove
This Label
N'enlevez Pas Cette
Étiquette

Type: Vented Gas Fireplace Heater

Model No. / Modèle: DRL36NI

Serial No.: X-XXXXXX-XXXXXX

Distributed by / distribué par: Canadian Heating Products Inc., Langley BC, (www.montigo.com)
Montigo DelRay Corp., Ferndale, WA, (www.montigo.com)

Tested To / Examiné A: CSA/ANSI Z21.88-2019 / CSA2.33-2019

Electrical Rating / Estimation Électrique: 15V / 1Ph / 60Hz / less than 12A
Altitude Rating / Estimation D'Altitude: N & H (0 - 4500 ft. / 0 - 1371 m.)

Fuel Type / Type De Carburant:

<input checked="" type="checkbox"/> Natural Gas / Gaz Naturel	<input type="checkbox"/> Propane / Gaz Propane
---	--

Vented Gas Fireplace Heater

Not for use with solid fuel. / Pas pour l'usage avec le combustible solide.
Not for use with air filters. / Pas pour l'usage avec des filtres à air.

DRL36NI

X-XXXXXX-XXXXXX

Canadian Heating Products Inc., Langley BC, (www.montigo.com)
Montigo DelRay Corp., Ferndale, WA, (www.montigo.com)

CSA/ANSI Z21.88-2019 / CSA2.33-2019

Electrical Rating / Estimation Électrique: 15V / 1Ph / 60Hz / less than 12A
Altitude Rating / Estimation D'Altitude: N & H (0 - 4500 ft. / 0 - 1371 m.)

Max. Input BTU/H	Min. Input BTU/H	Output / Rendement BTU/H	Orifice Size / Taille D'Orifice Front/Avant	Rear/Derrière	Gas Manifold Pressure / Pression D'Admission Du Gaz	Min. Gas Supply Pressure / Min. Pression D'Alimentation Du Gaz
16,000	16,000	N/A	49 DWS	N/A	3.5" W.C.	5.5" W.C.
16,000	16,000	N/A	1.15 mm	N/A	10" W.C.	13" W.C.

For Indoor Use Only



***Clearance to Combustibles / Dégagements Aux Combustibles**

Sides/Côtés:	1"
Back/Derrière:	2"
Top-Top Vent/Du Haut-Évent Du Haut:	21"
Top-Rear Vent/Du Haut-Évent Arrière:	N/A
Floor/Plancher:	0"
Mantel/Manteau:	6"
Recess Depth / Profondeur D'Encadrement:	14.25"
Flue:	1"

Refer to installation manual for more information. / Référez-vous au manuel d'installation pour plus d'information.

Made in China / Fabriqué en Chine

Figure 1.1 Rating Plate for DelRay DRL3613NI

US

Do Not Remove
This Label
N'enlevez Pas Cette
Étiquette

Type: Vented Gas Fireplace Heater

Model No. / Modèle: DRL48NI

Serial No.: X-XXXXXX-XXXXXX

Distributed by / distribué par: Canadian Heating Products Inc., Langley BC, (www.montigo.com)
Montigo DelRay Corp., Ferndale, WA, (www.montigo.com)

Tested To / Examiné A: CSA/ANSI Z21.88-2019 / CSA2.33-2019

Electrical Rating / Estimation Électrique: 15V / 1Ph / 60Hz / less than 12A
Altitude Rating / Estimation D'Altitude: N & H (0 - 4500 ft. / 0 - 1371 m.)

Fuel Type / Type De Carburant:

<input checked="" type="checkbox"/> Natural Gas / Gaz Naturel	<input type="checkbox"/> Propane / Gaz Propane
---	--

Vented Gas Fireplace Heater

Not for use with solid fuel. / Pas pour l'usage avec le combustible solide.
Not for use with air filters. / Pas pour l'usage avec des filtres à air.

DRL48NI

X-XXXXXX-XXXXXX

Canadian Heating Products Inc., Langley BC, (www.montigo.com)
Montigo DelRay Corp., Ferndale, WA, (www.montigo.com)

CSA/ANSI Z21.88-2019 / CSA2.33-2019

Electrical Rating / Estimation Électrique: 15V / 1Ph / 60Hz / less than 12A
Altitude Rating / Estimation D'Altitude: N & H (0 - 4500 ft. / 0 - 1371 m.)

Max. Input BTU/H	Min. Input BTU/H	Output / Rendement BTU/H	Orifice Size / Taille D'Orifice Front/Avant	Rear/Derrière	Gas Manifold Pressure / Pression D'Admission Du Gaz	Min. Gas Supply Pressure / Min. Pression D'Alimentation Du Gaz
21,000	21,000	N/A	2.15 mm	N/A	3.5" W.C.	5.5" W.C.
19,000	19,000	N/A	1.3 mm	N/A	10" W.C.	13" W.C.

For Indoor Use Only

***Clearance to Combustibles / Dégagements Aux Combustibles**

Sides/Côtés:	1"
Back/Derrière:	2"
Top-Top Vent/Du Haut-Évent Du Haut:	21"
Top-Rear Vent/Du Haut-Évent Arrière:	N/A
Floor/Plancher:	0"
Mantel/Manteau:	6"
Recess Depth / Profondeur D'Encadrement:	14.25"
Flue:	1"

Refer to installation manual for more information. / Référez-vous au manuel d'installation pour plus d'information.

Made in China / Fabriqué en Chine

Figure 1.2 Rating Plate for DelRay DRL4813NI



Type:	Vented Gas Fireplace Heater		For Indoor Use Only																						
	Not for use with solid fuel. / Pas pour l'usage avec le combustible solide.																								
	Not for use with air filters. / Pas pour l'usage avec des filtres à air.																								
Model No. Modèle:	DRL7213NI-2																								
Serial No.:	2-230712-000001																								
Distributed by / distribué par:	Canadian Heating Products Inc., Langley BC, (www.montigo.com) Montigo DelRay Corp., Ferndale, WA, (www.montigo.com) CSA/ANSI Z21.88-2019 / CSA2.33-2019																								
Tested To / Examiné À:	Electrical Rating / Estimation Électrique: 115V / 1Ph / 60Hz less than 12A Altitude Rating / Estimation D'Altitude: N & H (0 - 4500 ft. / 0 - 1371 m.)																								
Fuel Type / Type De Carburant:	<table border="1"> <tr> <td><input checked="" type="checkbox"/> Natural Gas / Gaz Naturel</td> <td>Max. Input BTU/H</td> <td>Min. Input BTU/H</td> <td>Output / Rendement BTU/H</td> <td>Office Size / Taille D'Office Front/Avant Rear/Derrière</td> <td>Gas Manifold Pressure / Pression D'Admission Du Gaz</td> <td>Min. Gas Supply Pressure / Min. Pression D'Alimentation Du Gaz</td> </tr> <tr> <td><input type="checkbox"/> Propane / Gaz Propane</td> <td>35,500</td> <td>24,500</td> <td>N/A</td> <td>2@2.00 mm / N/A</td> <td>3.5" W.C.</td> <td>5.5" W.C.</td> </tr> <tr> <td></td> <td>32,000</td> <td>25,000</td> <td>N/A</td> <td>2@1.15 mm / N/A</td> <td>10" W.C.</td> <td>13" W.C.</td> </tr> </table>				<input checked="" type="checkbox"/> Natural Gas / Gaz Naturel	Max. Input BTU/H	Min. Input BTU/H	Output / Rendement BTU/H	Office Size / Taille D'Office Front/Avant Rear/Derrière	Gas Manifold Pressure / Pression D'Admission Du Gaz	Min. Gas Supply Pressure / Min. Pression D'Alimentation Du Gaz	<input type="checkbox"/> Propane / Gaz Propane	35,500	24,500	N/A	2@2.00 mm / N/A	3.5" W.C.	5.5" W.C.		32,000	25,000	N/A	2@1.15 mm / N/A	10" W.C.	13" W.C.
<input checked="" type="checkbox"/> Natural Gas / Gaz Naturel	Max. Input BTU/H	Min. Input BTU/H	Output / Rendement BTU/H	Office Size / Taille D'Office Front/Avant Rear/Derrière	Gas Manifold Pressure / Pression D'Admission Du Gaz	Min. Gas Supply Pressure / Min. Pression D'Alimentation Du Gaz																			
<input type="checkbox"/> Propane / Gaz Propane	35,500	24,500	N/A	2@2.00 mm / N/A	3.5" W.C.	5.5" W.C.																			
	32,000	25,000	N/A	2@1.15 mm / N/A	10" W.C.	13" W.C.																			
FOR USE WITH GLASS DOORS AND SCREENS CERTIFIED WITH THE APPLIANCE ONLY																									
*Refer to installation manual for more information. *Référez-vous au manuel d'installation pour plus d'information.																									
LBA ANSI Z21.88-2019 RV. 12-9-2021																									
Made in China / Fabriqué en Chine																									

Figure 1.2 Rating Plate for DelRay DRL7213NI



Type:	Vented Gas Fireplace Heater		For Indoor Use Only																						
	Not for use with solid fuel. / Pas pour l'usage avec le combustible solide.																								
	Not for use with air filters. / Pas pour l'usage avec des filtres à air.																								
Model No. Modèle:	DRL6013NI																								
Serial No.:	2-210407-000001																								
Distributed by / distribué par:	Canadian Heating Products Inc., Langley BC, (www.montigo.com) Montigo DelRay Corp., Ferndale, WA, (www.montigo.com) CSA/ANSI Z21.88-2019 / CSA2.33-2019																								
Tested To / Examiné À:	Electrical Rating / Estimation Électrique: 115V / 1Ph / 60Hz less than 12A Altitude Rating / Estimation D'Altitude: N & H (0 - 4500 ft. / 0 - 1371 m.)																								
Fuel Type / Type De Carburant:	<table border="1"> <tr> <td><input checked="" type="checkbox"/> Natural Gas / Gaz Naturel</td> <td>Max. Input BTU/H</td> <td>Min. Input BTU/H</td> <td>Output / Rendement BTU/H</td> <td>Office Size / Taille D'Office Front/Avant Rear/Derrière</td> <td>Gas Manifold Pressure / Pression D'Admission Du Gaz</td> <td>Min. Gas Supply Pressure / Min. Pression D'Alimentation Du Gaz</td> </tr> <tr> <td><input type="checkbox"/> Propane / Gaz Propane</td> <td>28,000</td> <td>28,000</td> <td>N/A</td> <td>2.45 mm / N/A</td> <td>3.5" W.C.</td> <td>5.5" W.C.</td> </tr> <tr> <td></td> <td>25,000</td> <td>25,000</td> <td>N/A</td> <td>1.45 mm / N/A</td> <td>10" W.C.</td> <td>13" W.C.</td> </tr> </table>				<input checked="" type="checkbox"/> Natural Gas / Gaz Naturel	Max. Input BTU/H	Min. Input BTU/H	Output / Rendement BTU/H	Office Size / Taille D'Office Front/Avant Rear/Derrière	Gas Manifold Pressure / Pression D'Admission Du Gaz	Min. Gas Supply Pressure / Min. Pression D'Alimentation Du Gaz	<input type="checkbox"/> Propane / Gaz Propane	28,000	28,000	N/A	2.45 mm / N/A	3.5" W.C.	5.5" W.C.		25,000	25,000	N/A	1.45 mm / N/A	10" W.C.	13" W.C.
<input checked="" type="checkbox"/> Natural Gas / Gaz Naturel	Max. Input BTU/H	Min. Input BTU/H	Output / Rendement BTU/H	Office Size / Taille D'Office Front/Avant Rear/Derrière	Gas Manifold Pressure / Pression D'Admission Du Gaz	Min. Gas Supply Pressure / Min. Pression D'Alimentation Du Gaz																			
<input type="checkbox"/> Propane / Gaz Propane	28,000	28,000	N/A	2.45 mm / N/A	3.5" W.C.	5.5" W.C.																			
	25,000	25,000	N/A	1.45 mm / N/A	10" W.C.	13" W.C.																			
FOR USE WITH GLASS DOORS AND SCREENS CERTIFIED WITH THE APPLIANCE ONLY																									
*Refer to installation manual for more information. *Référez-vous au manuel d'installation pour plus d'information.																									
LBA ANSI Z21.88-2019 RV. 12-9-2021																									
Made in China / Fabriqué en Chine																									

Figure 1.1 Rating Plate for DelRay DRL6013NI

DRL
36

DRL
48

Section 1: Dimensions

DelRay 36, 48 Dimensions

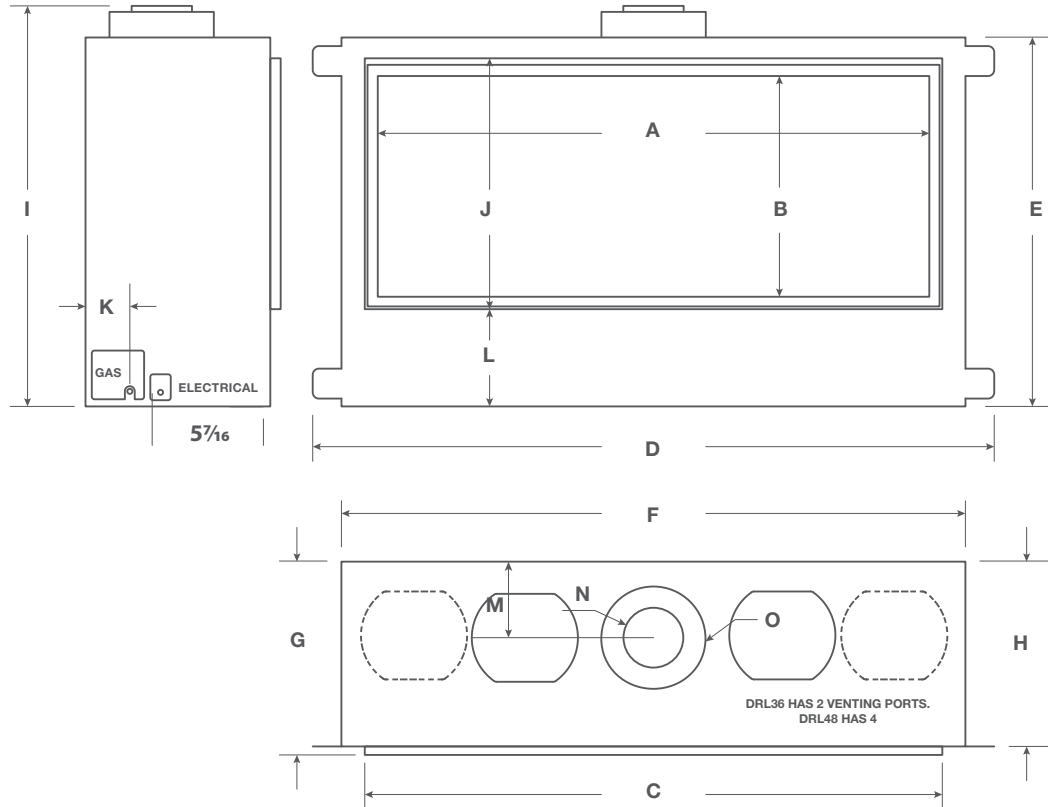

	A	B	C	D	E	F	G	H	I	J	K	L	M	N	O
DRL36	36½	14 ¹¹ / ₁₆	38 ³ / ₈	45¼	24¼	41 ³ / ₈	12¾	12 ⁵ / ₁₆	26¾	16 ⁵ / ₈	3⅛	6 ⁹ / ₁₆	5	4	7
DRL48	48½	14 ¹¹ / ₁₆	50 ⁵ / ₁₆	57¼	24½	53 ⁷ / ₁₆	12¾	12 ⁵ / ₁₆	26¾	16 ⁵ / ₈	3⅛	6 ⁹ / ₁₆	5	4	7

NOTICE

DelRay DRL7213 uses 5/8 venting

DRL
60

DRL
72

DelRay 60, 72 Dimensions

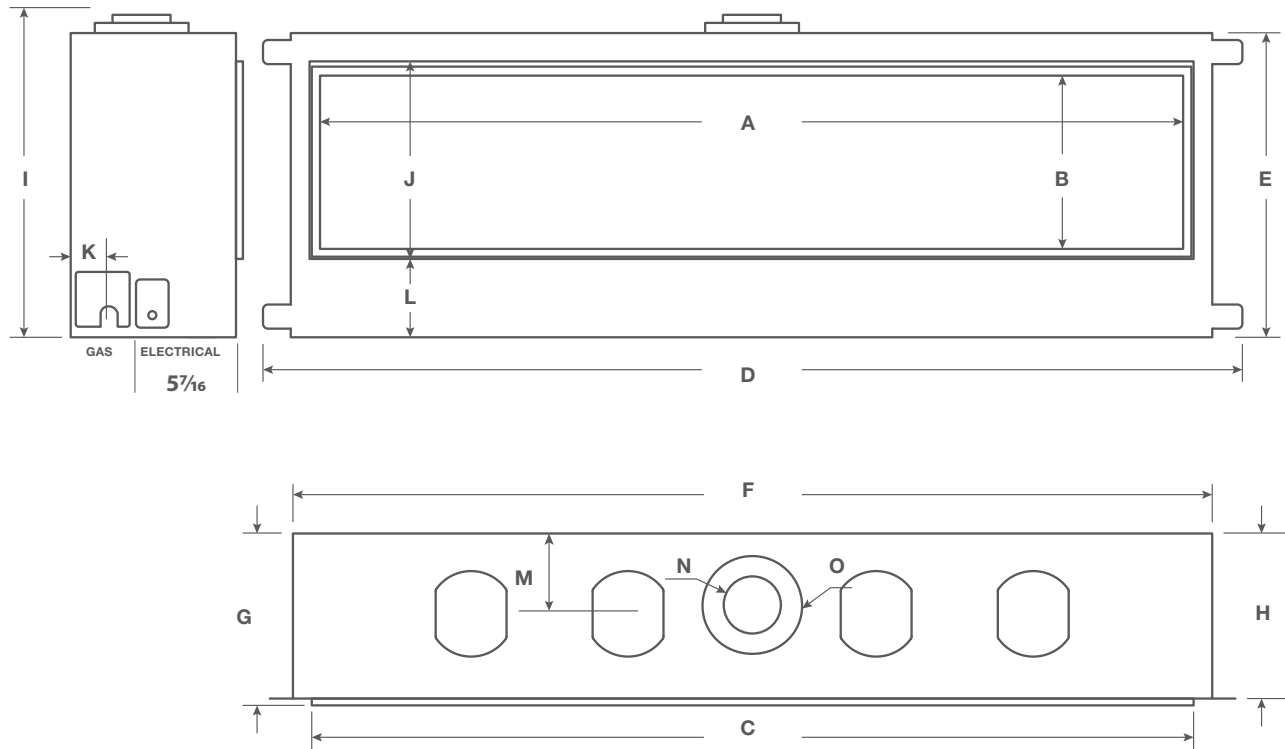

	A	B	C	D	E	F	G	H	I	J	K	L	M	N	O
DRL60	60 ¹ / ₂	14 ¹¹ / ₁₆	62 ¹ / ₂	69 ¹ / ₄	24 ¹ / ₂	65 ⁵ / ₁₆	12 ³ / ₄	12 ⁵ / ₁₆	26 ³ / ₄	16 ⁵ / ₈	3 ¹ / ₈	6 ⁹ / ₁₆	5	4	7
DRL72	72 ¹ / ₂	14 ¹¹ / ₁₆	74 ³ / ₈	82 ³ / ₄	25 ⁷ / ₁₆	77 ⁷ / ₁₆	14 ⁷ / ₁₆	13 ¹⁵ / ₁₆	27	16 ¹ / ₂	3 ¹ / ₈	6 ⁹ / ₁₆	5 ¹⁵ / ₁₆	5	8

LVP and delicate flooring

Flooring such as Luxury Vinyl Plank (LVP) and other vinyl flooring can be sensitive to radiant heat and changes in temperature. If using vinyl flooring we recommend you install the fireplace in one of the ways shown below.

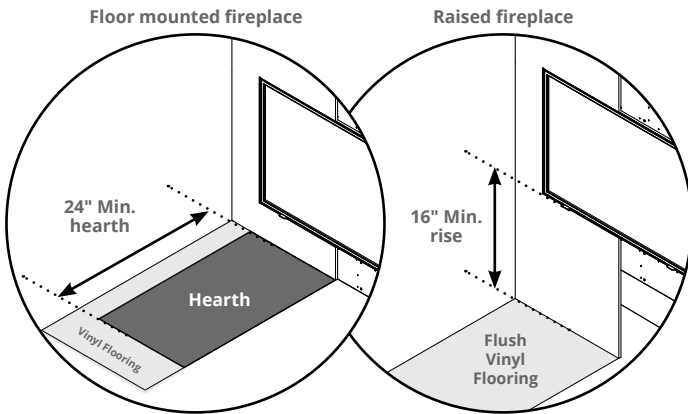

The minimum depth of the hearth is 24" if the fireplace base is flush with the floor (ie; not raised, and not recessed into the floor)

The minimum width of the hearth is equal to the width of the fireplace opening.

Raise the fireplace so the opening is 16" above the floor to allow for vinyl flooring to be installed flush to the wall. (Measured from floor to the bottom of the door opening)

Recommended floor recess considerations

DelRay fireplaces can be recessed into the floor, though a 10" non-combustible hearth is recommended. Please consult flooring manufacturer for safe temperatures, when fireplace is in operation temperatures may get up to 180°F.

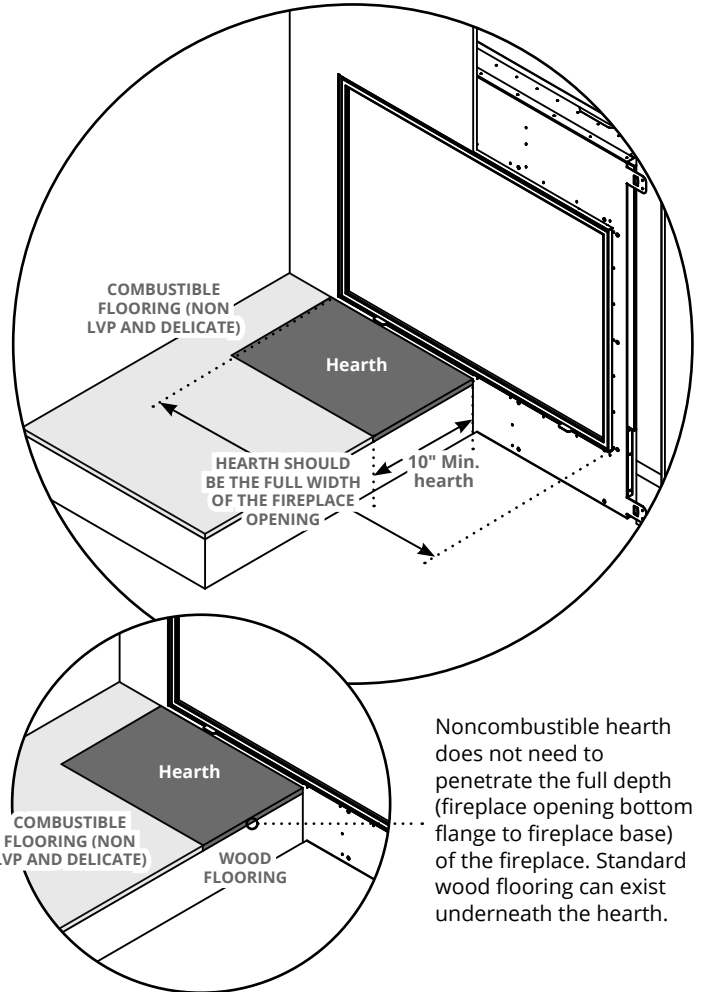

Noncombustible hearth does not need to penetrate the full depth (fireplace opening bottom flange to fireplace base) of the fireplace. Standard wood flooring can exist underneath the hearth.

DRL
36

DRL
48

Section 2: Framing

Framing Dimensions 36", 48"

- 1). Frame in the enclosure for the unit with framing materials. The framed opening for the assembled fireplace shown below in table

NOTE: When constructing the framed opening, please ensure there is access to install the gas line when the unit is installed

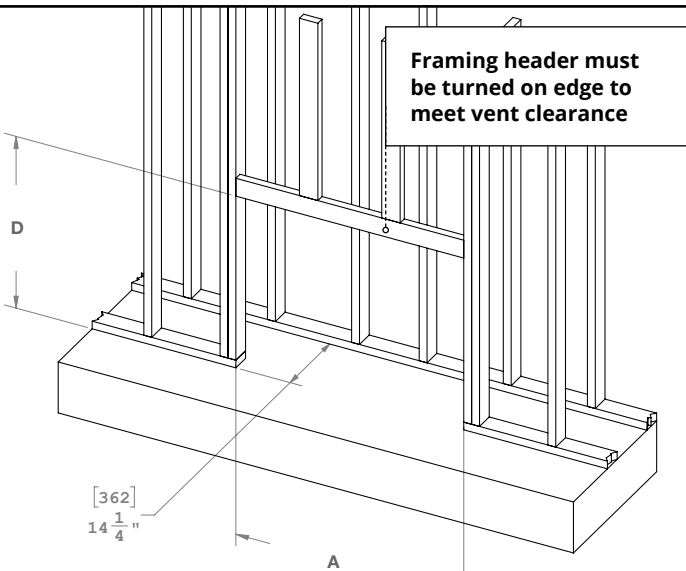

Figure 3.a Framing dimensions table

DRL*3613 DIMENSIONS

A	B	C	D
43 $\frac{3}{8}$ "	67 $\frac{5}{8}$ "	47 $\frac{1}{2}$ "	33 $\frac{11}{16}$ "
26 $\frac{1}{2}$ " when chase is ventilated)			

DRL*4813 DIMENSIONS

A	B	C	D
55 $\frac{3}{8}$ "	79 $\frac{1}{4}$ "	56 $\frac{1}{16}$ "	33 $\frac{11}{16}$ "
26 $\frac{1}{2}$ " when chase is ventilated)			

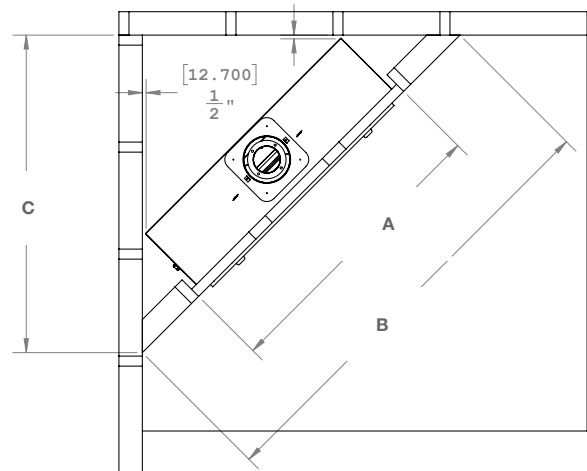

Figure 3.b Framing dimensions (Straight wall & Corner Installation).

WARNING

When this appliance is installed directly on ANY combustible other than wood flooring (carpet, vinyl, etc.). It must be installed on an equivalent wood or metal panel. This material must extend the full width and depth of the appliance.

NOTICE

Clearances must be in accordance with local installation codes and the requirements of the gas supplier

DRL
60

DRL
72

Framing Dimensions 60", 72"

1). Frame in the enclosure for the unit with framing materials. The framed opening for the assembled fireplace shown below in table

NOTE: When constructing the framed opening, please ensure there is access to install the gas line when the unit is installed

The DRL60 and DRL72 comes standard with a non-combustible steel stud and a heat deflector. The heat deflector must be installed at the dimension shown in the table as "F" and the steel stud is then installed 1" above fireplace.

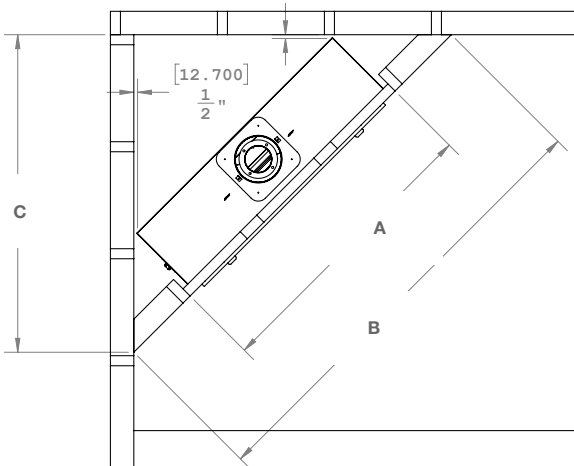
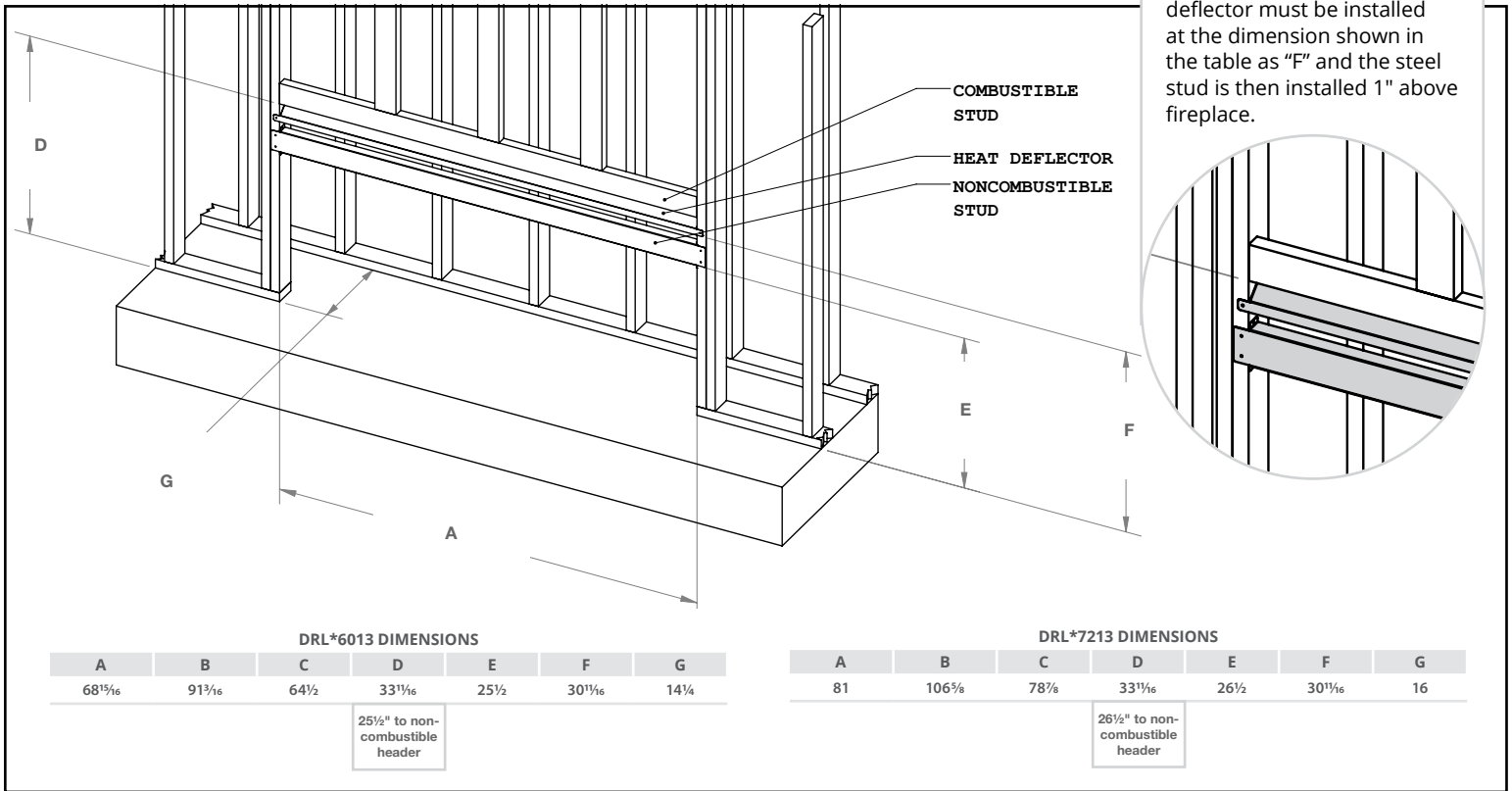

⚠ WARNING

When this appliance is installed directly on ANY combustible other than wood flooring (carpet, vinyl, etc.). It must be installed on an equivalent wood or metal panel. This material must extend the full width and depth of the appliance.

NOTICE

Clearances must be in accordance with local installation codes and the requirements of the gas supplier

DRL
36

DRL
48

DRL
60

DRL
72

Clearances

When installing a shelf over the top of the fireplaces, the following guidelines must be adhered to:

MODEL	Top - Top vent †	Rear	Sides	Floor	Mantel	Vent Pipe
DRL3613*I	21"	2"	1"	0"	6"	1" all around 2" on the horizontal
DRL4813*I	21"	2"	1"	0"	6"	1" all around 2" on the horizontal
DRL6013*I	36"	2"	1¾"	0"	6"	1" all around 2" on the horizontal
DRL7213*I	38½"	2"	1¾"	0"	10"	1" all around 2" on the horizontal

Figure 4. Combustible Wall Clearances

NOTES:

† Clearance from top of fireplace to a ceiling within the fireplace enclosure.

Clearance to Sprinkler

- Maintain 48" of clearance to openings from which heat is discharged such as chase venting and Cool Wall Advantage.
- Please follow local building codes to determine what sprinkler head sensor setting is relevant for your installation.

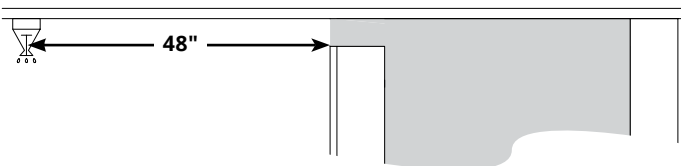

DRL
36

DRL
48

DRL
60

DRL
72

Header on edge clarification

In order to both support the cement board AND provide sufficient clearance between framing and venting, the header is shown installed on edge. In many applications, such as up-and-out venting, a traditional horizontal header can be installed with after the vent elbow as long as sufficient clearances are maintained.

! WARNING

These installs are shown without the required stud heat deflectors (and a steel stud kit for the DRL60 and 72.) These components are required and must be part of your framing.

STRAIGHT VERTICAL VENTING

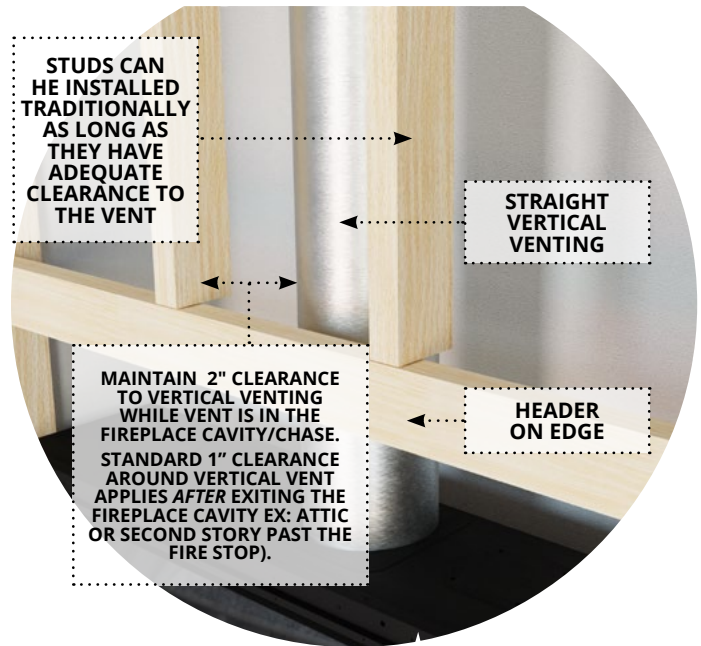

UP-AND-OUT VENTING

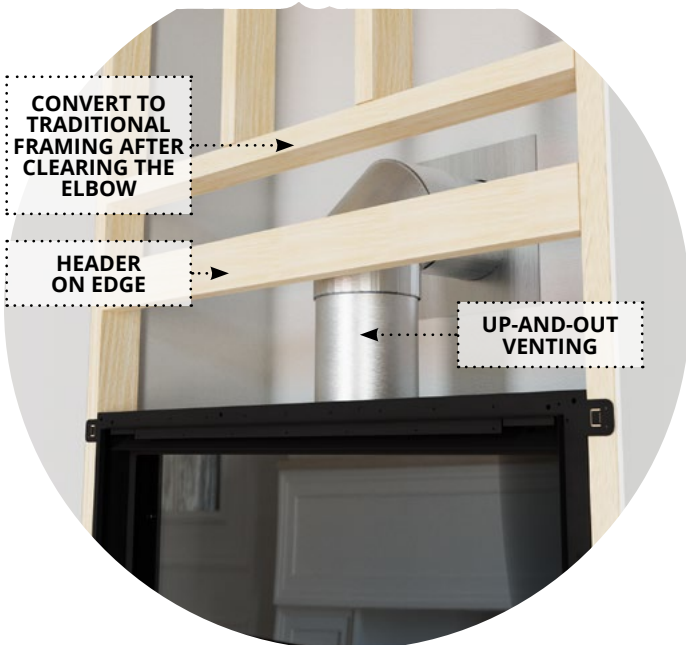

UP-AND-OUT SIDEWALL VENTING

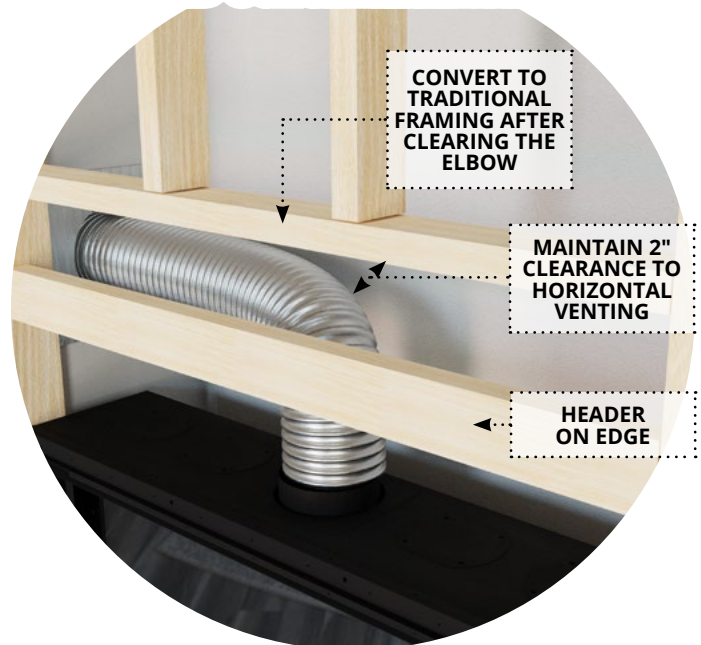

The use of flex venting in the scenario shown above makes the installation easier as it allows for a lower combustible header height AND accommodates the bend the vent has to take due to the shallow framing depth.

DRL
36

DRL
48

36, 48 Standard installation

NO RECESS

NON-COMBUSTIBLE FACING

	DRL36	DRL48
16"	130°	150°
12"	140°	160°
8"	160°	170°
4"	175°	180°

IMPORTANT

Temperatures are based off of the minimum enclosure size at a 3 hour burn time

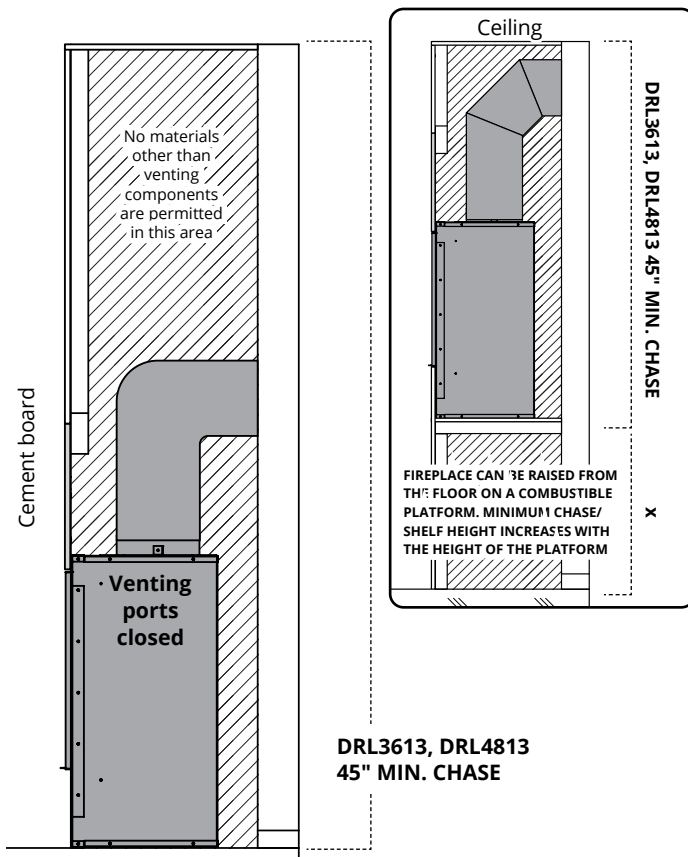

36, 48 Standard installation (Shelf over)

NO RECESS

NON-COMBUSTIBLE FACING

	DRL36	DRL48
16"	130°	150°
12"	140°	160°
8"	160°	170°
4"	175°	180°

IMPORTANT

Temperatures are based off of the minimum enclosure size at a 3 hour burn time

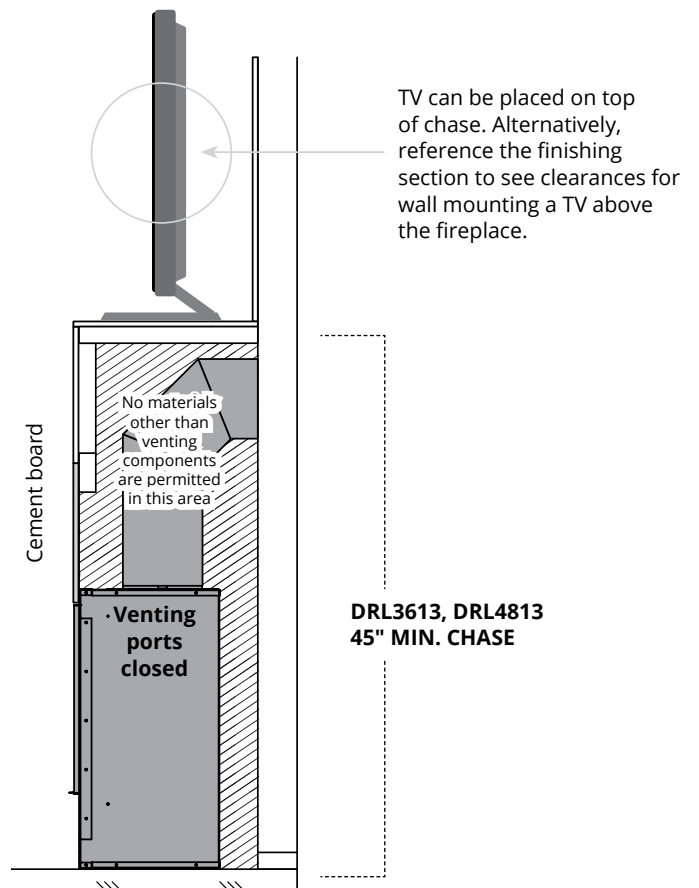

⚠ WARNING

Combustible facing material not allowed with standard minimum chase

⚠ WARNING

Combustible facing material not allowed with standard minimum chase

DRL
36

DRL
48

36, 48 Vented installation (Cool Wall Release)

NO RECESS

COMBUSTIBLE FACING

NO FANS

	DRL36	DRL48
16"	95°	90°
12"	95°	95°
8"	100°	100°
4"	105°	105°

IMPORTANT

Temperatures are based off of the minimum enclosure size at a 3 hour burn time

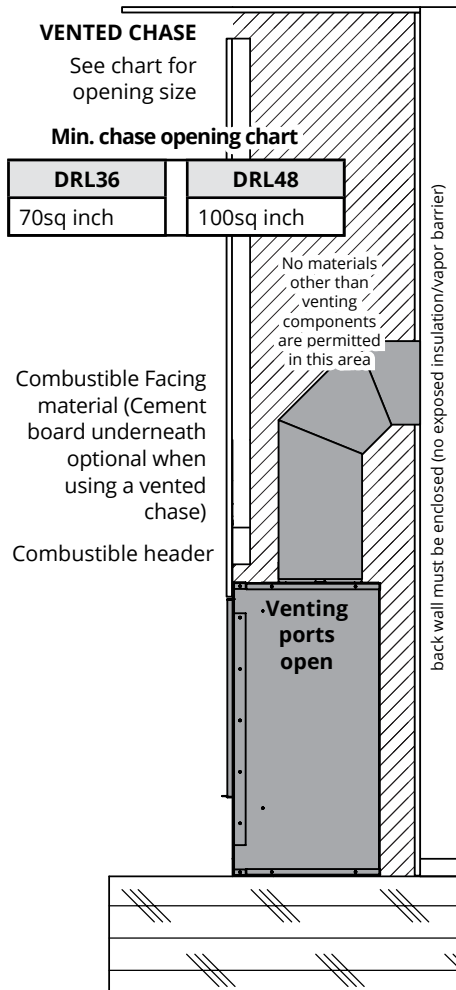

IMPORTANT

Leaving the venting ports open requires a minimum chase height of 6'

WARNING

Vented chase height must be no less than 6'

WARNING

Vented chase opening is mandatory when you open fireplace vent ports (all ports must be open).

Venting ports (shown on a DRL3613)

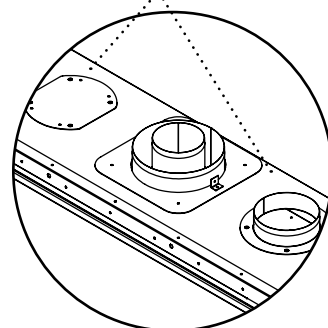

WARNING

Vented installations require that the chase inner wall must be enclosed (no exposed insulation/vapour barrier) Follow local codes

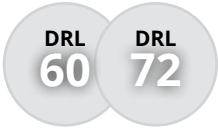

60, 72 Standard installation

NO RECESS

NON-COMBUSTIBLE FACING

	DRL60	DRL72
16"	140°	145°
12"	155°	160°
8"	175°	180°
4"	200°	195°

IMPORTANT

Temperatures are based off of the minimum enclosure size at a 3 hour burn time

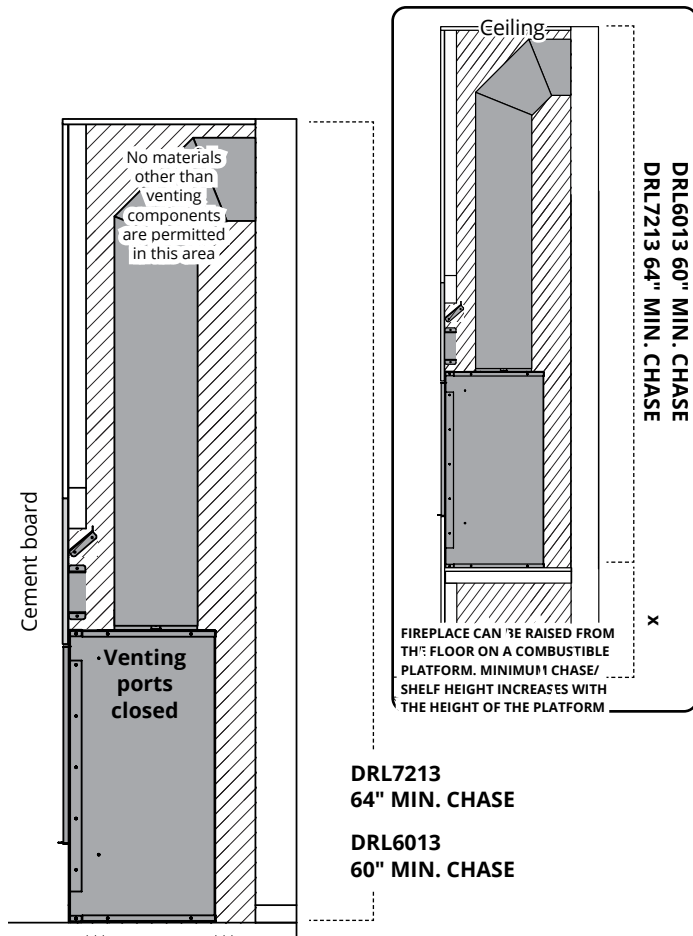

60, 72 Standard installation (Shelf over)

NO RECESS

NON-COMBUSTIBLE FACING

	DRL60	DRL72
16"	140°	145°
12"	155°	160°
8"	175°	180°
4"	200°	195°

IMPORTANT

Temperatures are based off of the minimum enclosure size at a 3 hour burn time

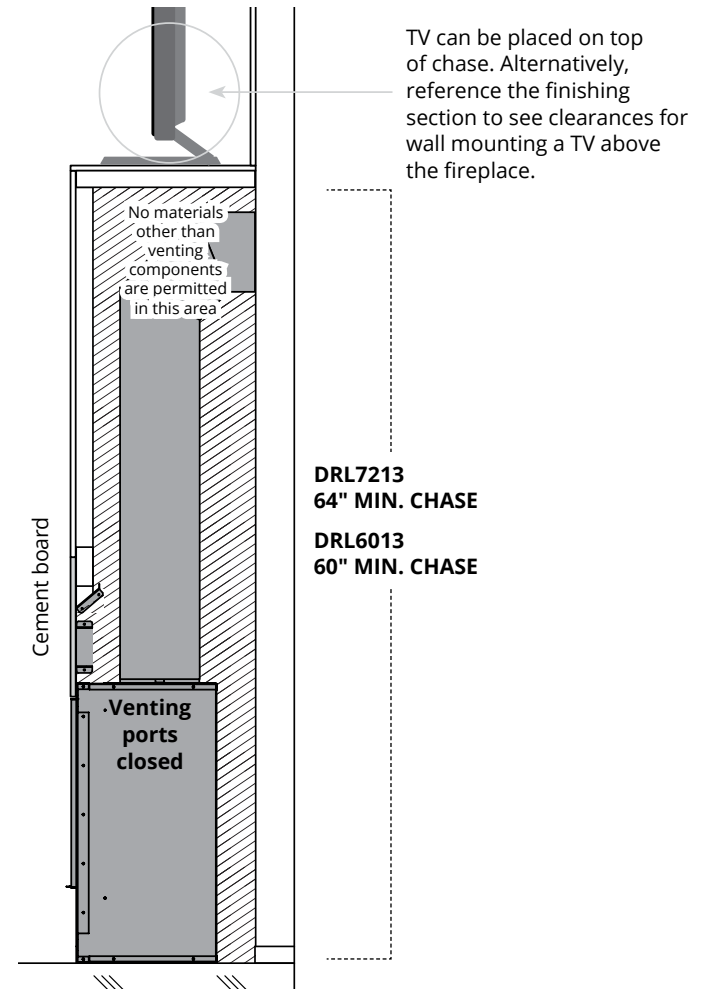

⚠ WARNING

Combustible facing material not allowed with standard minimum chase

⚠ WARNING

Combustible facing material not allowed with standard minimum chase

DRL
60

DRL
72

Vented installation (Cool Wall Release)

NO RECESS

COMBUSTIBLE FACING

NO FANS

	DRL60	DRL72
16"	100°	100°
12"	105°	105°
8"	115°	115°
4"	120°	120°

IMPORTANT

Temperatures are based off of the minimum enclosure size at a 3 hour burn time

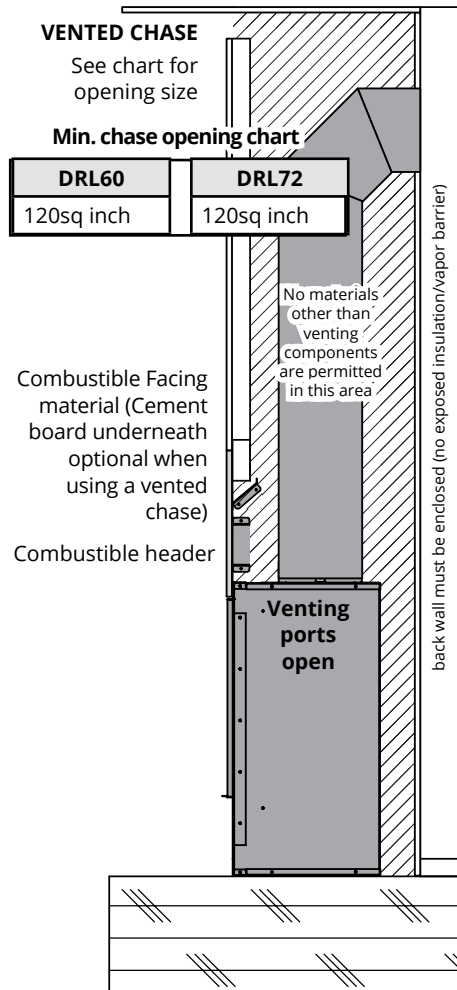

IMPORTANT

Leaving the venting ports open requires a minimum chase height of 6'

⚠ WARNING

Vented chase height must be no less than 6'

⚠ WARNING

Vented chase opening is mandatory when you open fireplace vent ports (all ports must be open).

Venting ports (shown on a DRL3613)

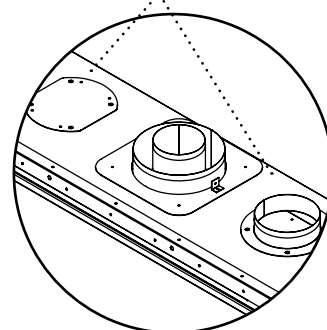

⚠ WARNING

Vented installations require that the chase inner wall must be enclosed (no exposed insulation/vapour barrier) Follow local codes

Section 3: Venting

WARNING

The use of the fans when the Cool Wall Release OR Cool Wall Advantage system is used will result in significantly higher wall temperatures. These higher temperatures can negatively impact the finished wall surface, art, and or mounted TV. Therefore, Montigo **STRONGLY RECOMMENDS** that fans be disconnected when the Cool Wall Release OR Cool Wall Advantage system is used. This can be done through the remote control (See instructions) or by disconnecting the fan harness. Montigo is **NOT** responsible for damage to facing materials, and items placed above the fireplace (eg. TV, artwork)

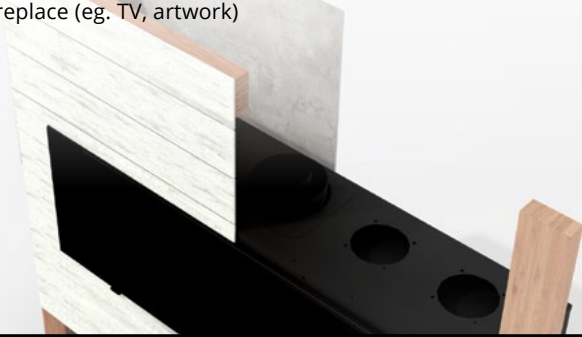

FULL LOAD VERSIONS:

Disable fans via remote

1. Turn the fireplace on, turn fans to off setting.
2. Partially take out one battery.
3. Hold both the Mode AND On/Off button.
4. Insert battery (while still holding the two buttons), then release Mode button (keep On/Off pressed).
5. Cycle through modes with Mode button until you get to fan setting, with Down button set fan function from Set to Clr.
6. Release On/Off button, turn the fireplace on. There will be now be no fan mode on remote.

BASIC VERSIONS (IF OPTIONAL FAN KIT ALREADY INSTALLED):

Disable fans via harness

1. Unplug the fan harness that connects power to the speed control.



Montigo offers a variety of direct venting and termination options. The direct vent termination location **MUST** be selected such that it is the highest point in the venting assembly. It should also be selected such that it provides the shortest vent run possible. Should it be impossible to ensure that the termination is the highest point or to meet the venting guidelines laid out below please contact your Montigo dealer to discuss power venting options.

Notes For Planning Venting:

- Venting originates from the top of the unit
- Venting can terminate through the roof or through an exterior wall.
- Refer to Appendix A - Termination Locations to ensure the planned termination location is acceptable.
- Once the termination location has been established, refer to the appropriate section below for installation details
- All fireplaces shipped from the factory are top vent.
- **Silicone** application is **NOT** required when joining Montigo vent pipes and components.

NOTICE

Under no circumstances can Montigo flex venting be cut to accommodate an installation. Use an alternative length to complete your vent run. (Excluding flex included in the MVK05 / MVK05F / PVK05 / PVK05F)

FLEXMASTER VENT KITS -

Flexmaster venting kits are prepackaged sets of flex venting, wall shields, and terminations. The flex is collarless and must be milpacked and screwed. These kits are approved for all 4/7 and 5/8 fireplaces though cannot be used when the unit is powervented.



Figure 4.a MVK05 / MVK05F Flex Vent Kit

Section 3-3-1: Venting Layout

DRL36 & DRL48 Venting -

Wall and roof termination

Maximum total vent run allowed is 34 ft. (V+H ≤ 34ft.)

For longer vent runs, a power vent is required

V + H are measured from the center of vent elbows

Maximum vertical run allowed is 34 ft. (V max).

Maximum horizontal run allowed is 20 ft. (H max).

Elbows:

Max elbows = 4

Two 45° elbows = 90° elbow

Each elbow reduces vent run by 3'

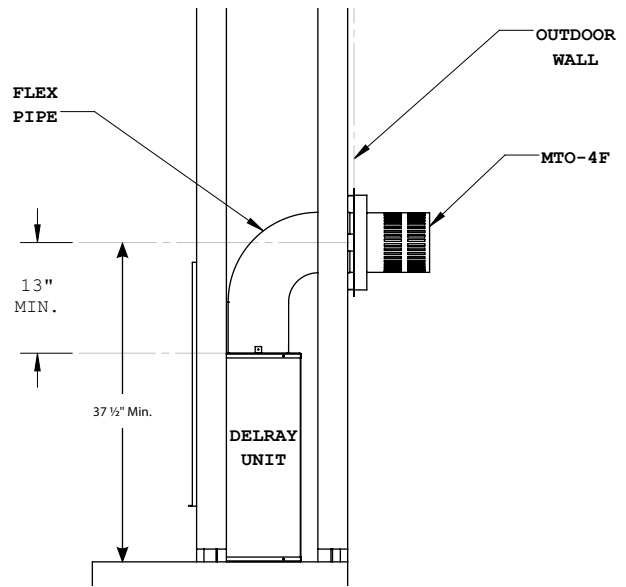
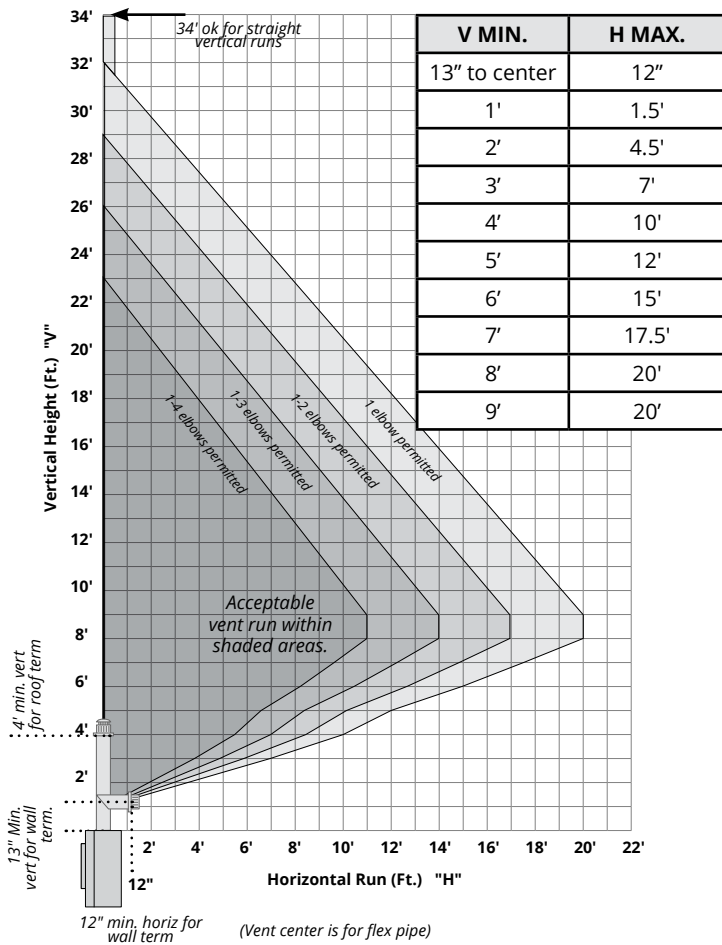

Figure 4.bb Minimum Horizontal vent run (Flex)

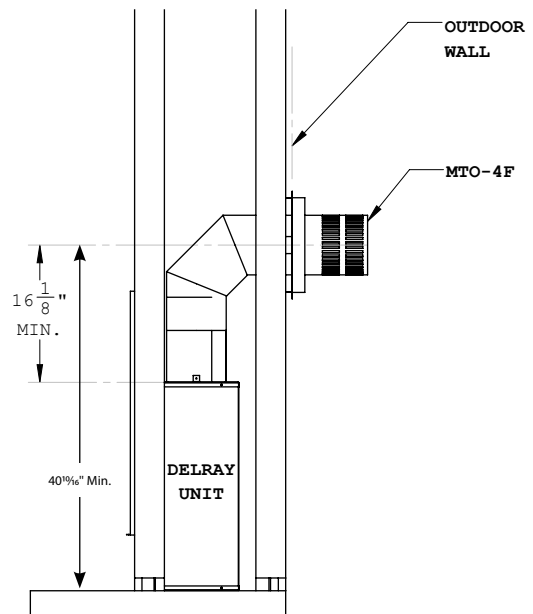

Figure 4.bb Minimum Horizontal vent run (Rigid)

DRL60 Venting -

Wall and roof termination

Maximum total vent run allowed is 34 ft. ($V+H \leq 34\text{ft.}$)

For longer vent runs, a power vent is required

V + H are measured from the center of vent elbows

Maximum vertical run allowed is 34 ft. (V max).

Maximum horizontal run allowed is 26 ft. (H max).

Elbows:

Max elbows = 4

Two 45° elbows = 90° elbow

Each elbow reduces vent run by 3'

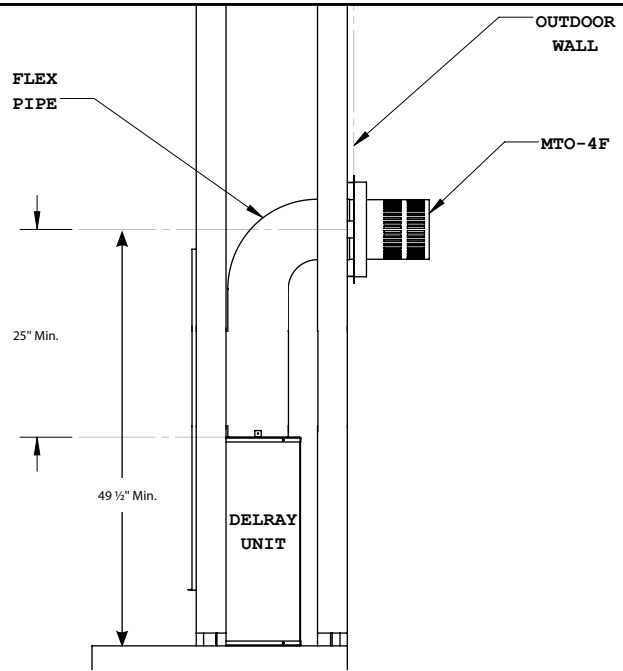
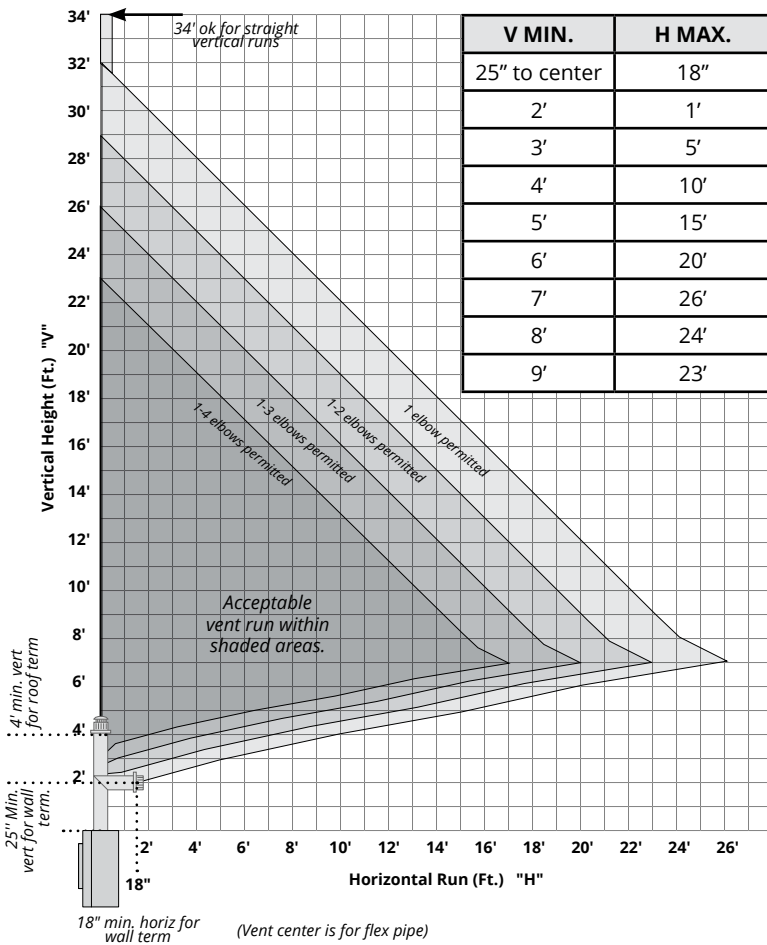

Figure 4.bb Minimum Horizontal vent run (Flex)

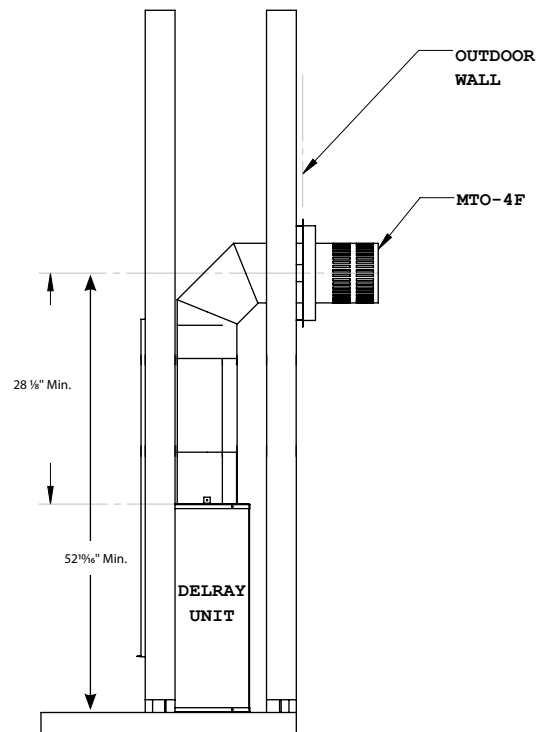

Figure 4.bb Minimum Horizontal vent run (Rigid)

DRL72 Venting -

Wall and roof termination

Maximum total vent run allowed is 34 ft. ($V+H \leq 34\text{ft.}$)

For longer vent runs, a power vent is required

V + H are measured from the center of vent elbows

Maximum vertical run allowed is 34 ft. (V max).

Maximum horizontal run allowed is 26 ft. (H max).

Elbows:

Max elbows = 4

Two 45° elbows = 90° elbow

Each elbow reduces vent run by 3'

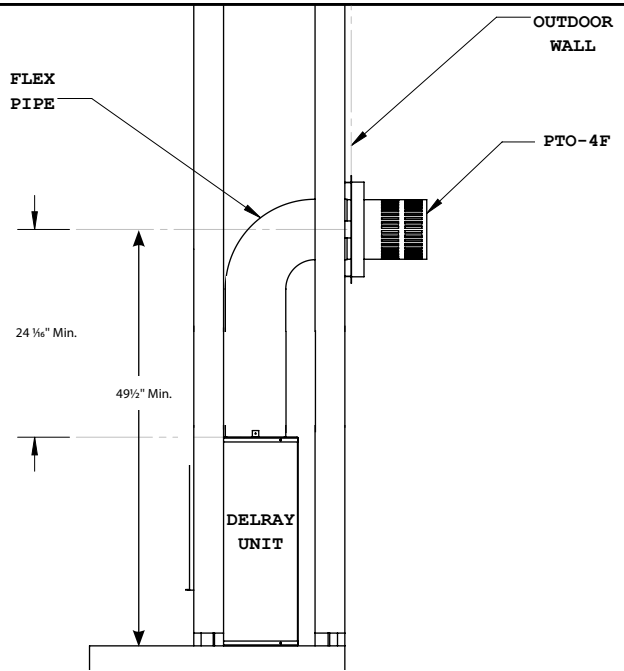
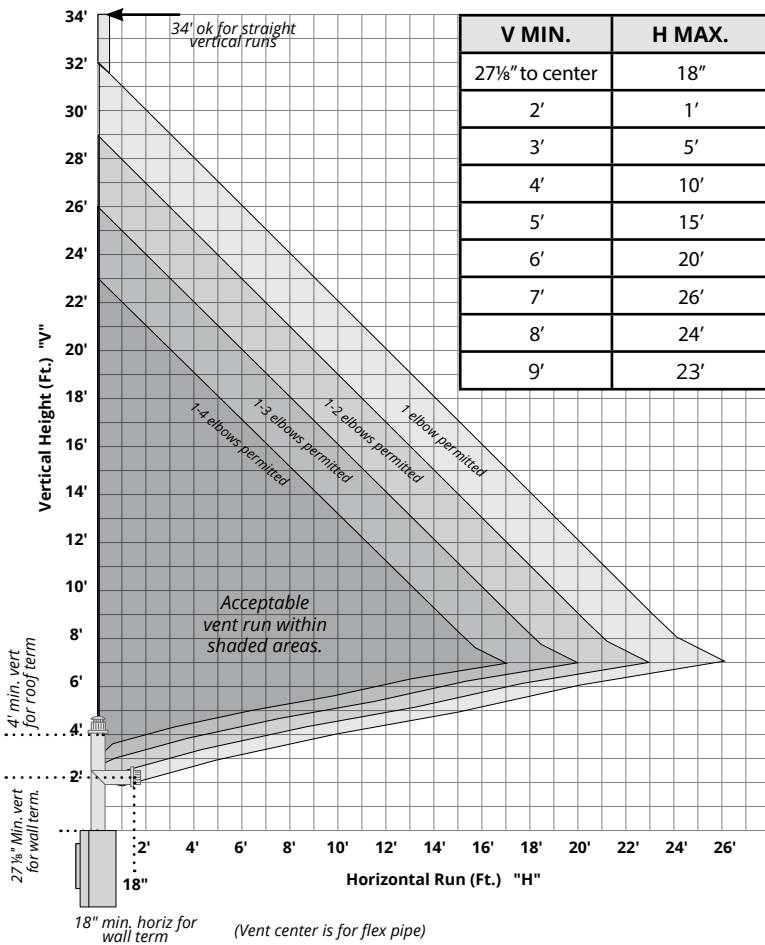

Figure 4.bb Minimum Horizontal vent run (Flex)

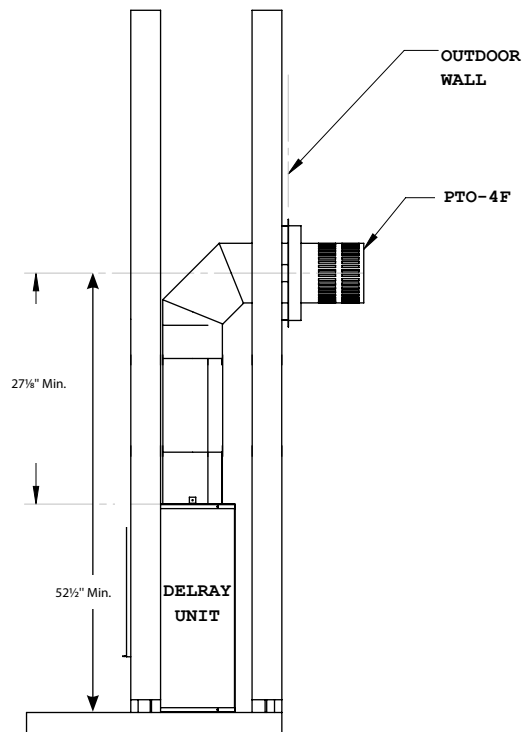

Figure 4.bb Minimum Horizontal vent run (Rigid)

DRL
36

DRL
48

DRL
60

Co-linear venting into existing masonry chimney

The appliance can be adapted to co-linear applications using an existing chimney. The appliance must not be connected to a chimney flue serving a separate solidfuel burning appliance such as a wood burning fireplace.

- Maximum 30 feet vertical pipe
- Minimum 10 feet vertical
- Restrictor usage recommended for longer vertical runs
- Keep the flexible liner as straight as possible, avoid unnecessary bending
- A maximum of two certified couplers may be used per length of 3" liner
- DelRay co-linear installation requires reducing from Montigo 4/7 to Duravent 4x6%

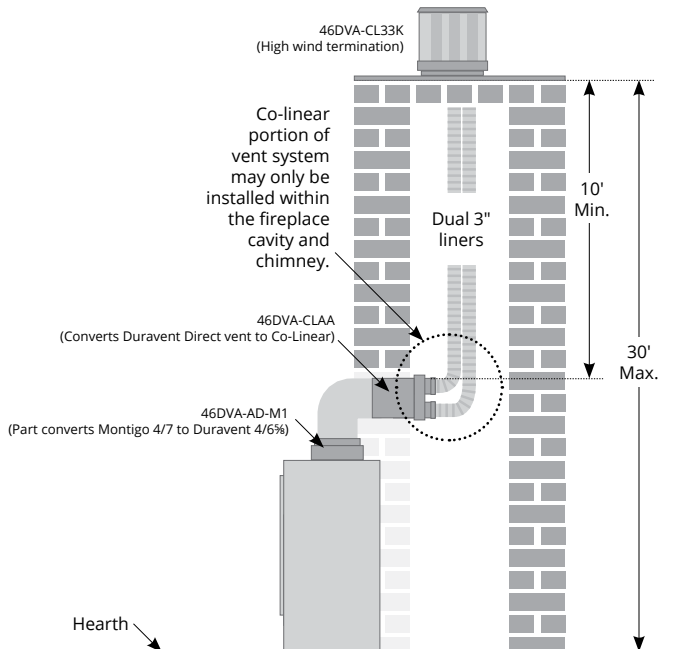

Figure 99.a Co-linear top vented configuration.

NOTICE

The unit must be fully enclosed while maintaining clearances to combustibles detailed elsewhere in this manual

NOTICE

Not permitted for use with the DRL72

Section 3-2: Installing a Roof Vent Termination

Section 3-2-1: Roof Venting termination

- The maximum termination point is 32' above the fireplace (NOTE: if the maximum termination height is used, the flame pattern may be affected).
- The Vertical termination must be a minimum 2' higher than where the termination exits the roofing materials, (asphalt shingles, cedar shakes, etc). This distance should be measured from the high side of the roof slope where the flue flashing intersects the roofing materials. (see Figures 8 to 8c).
- See Appendix A for termination locations.
- A maximum of two offsets (each offset is made up of 2-90° bends) may be made for vertical vent runs.

- Firestops must be installed as required by National & local codes.
- Ensure all horizontal runs are supported with a minimum of 3 supports per 10' of venting.
- Install all roof flashing and storm collars as shown.

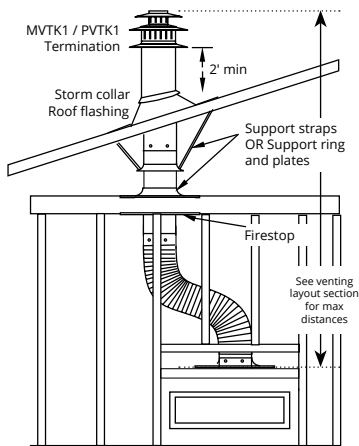

Figure 6.b Top vent, Roof mounted with 1 offset (1 offset= two 90° bends).

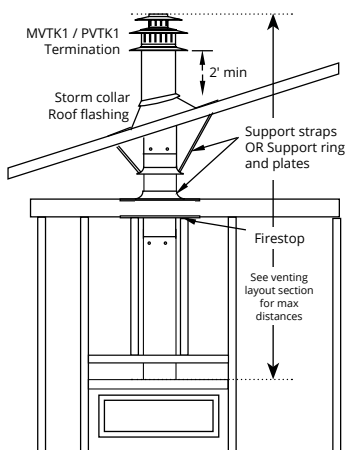

Figure 6. Top vent, roof mounted termination with no offset in vent run.

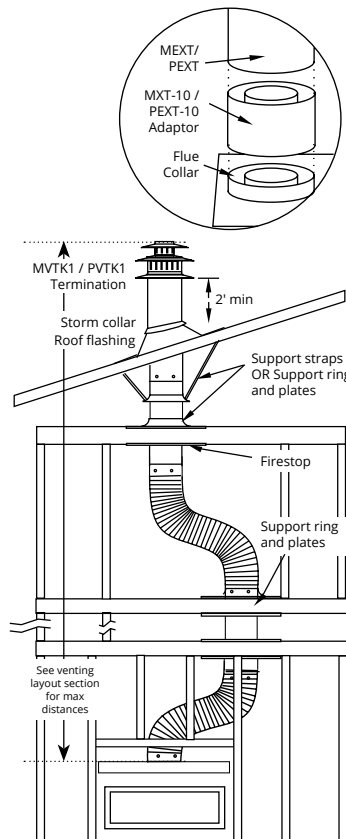

Figure 6.c Top vent, Roof mounted with 2 offsets (1 offset= two 90° bends).

DRL
36

DRL
48

DRL
60

DRL
72

Section 3-3: Installing a Wall Mounted Termination

This section applies to installations where the direct vent termination will be wall mounted. **NOTE:** If subject to a highly corrosive environment i.e. Seaside, Montigo recommends using Stainless Steel Termination.

Installation of termination with built in frame

A termination with a built-in frame is installed during framing of a structure.

1. Frame the termination opening to 11" x 11".
2. Install exterior sheathing to the structure framing.
3. Fasten the termination to the sheathing using a minimum of 4 screws.

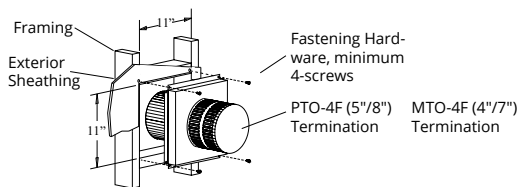

Figure 7. Installing a PTO4-F, MTO4-F termination.

Installation of termination frame at time of framing

Terminations with a MSR frame allow the installation of the frame prior to installation of the termination.

1. Frame the termination opening to 12" x 12".
2. Secure the MSR Frame to the exterior sheathing of the structure.
3. Fasten the termination to the MSR Frame using a minimum of 4 screws.

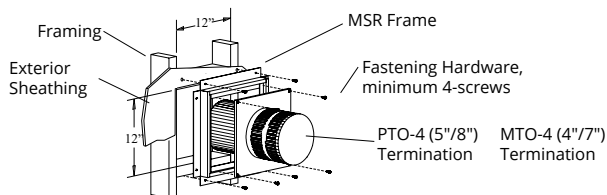

Figure 7.b Installing a MTO, PTO termination with the MSR frame.

Installation of termination frame at time of framing in masonry

Terminations with a BSR frame allow the installation of the frame in masonry prior to the installation of the termination

1. Frame the BSR opening to 12" x 12".
2. Secure the BSR Frame to the exterior sheathing of the structure.
3. Fasten the termination to the BSR Frame using a minimum of 4 screws.

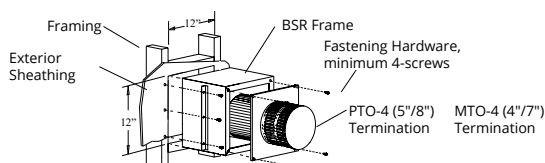

Figure 7.c Installing a MTO, PTO termination with the BSR frame.

Installation of termination from inside structure

A Termination with a MOSR Frame is installed from the inside of the structure. These are commonly used in high-rise construction.

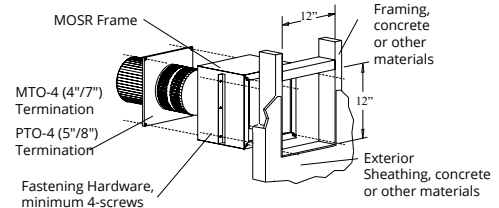

Figure 7.d Installing a PTO termination with MOSR frame.

1. Frame the MOSR opening to 12" x 12".
2. Fasten the MOSR frame to the interior side of the studs, concrete, or finished wall construction using a minimum of 4 screws.
3. Insert the termination into the MOSR frame as shown here, (from the inside) and attach to the MOSR by installing a min. quantity of 4 bolts into the threaded nuts on the MOSR Frame.

Installation of a termination shield for vinyl siding

The VSS Termination shield is installed when the exterior of a structure is clad with Vinyl siding. It is placed directly above, and on-center with the termination.

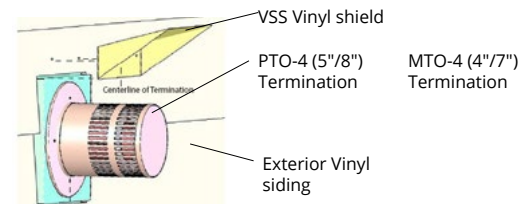

Figure 7.e Installing the VSS Vinyl Shield.

Installing heat guards

Installing heat guards over terminations is recommended in installations where the termination is located within 7' feet above grade, or above a pedestrian walkway, and may be required by code in public areas.

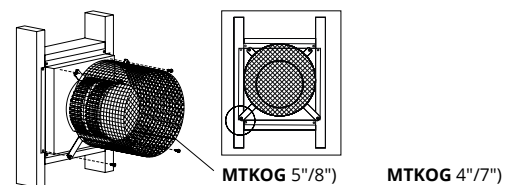
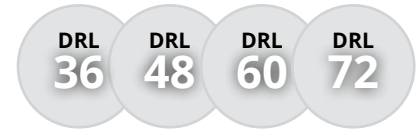

Figure 7.f Installing a MTO, PTO termination heat guard.

1. Ensure that the two long mounting brackets are facing the bottom of the termination (See inset). This will provide more heat protection at the top of the termination, where temperatures are highest.
2. Attach to the faceplate of the termination using four sheet metal screws.

Section 3-3-2: Venting Components

The following components and associated Montigo part numbers are for installation of a roof or wall mounted termination. Use of non-Montigo approved parts will VOID the warranty and may impede operation of the fireplace.



Connection and installation of the vent components should adhere to the following guidelines:

- Use any combination of rigid and flex pipe as required and in any orientation (Male connectors can face in any direction).
- Flex sections may be stretched up to 50% of their total length (e.g. a 24" section maybe stretched to 36").
- Connect all vent sections using a minimum of three sheet metal screws on the outer pipe flue.
- Ensure the pipe ends male to female slide in a minimum of 1 1/2" of overlap.
- Ensure all horizontal runs are supported with a minimum of 3 supports per 10' of venting.
- When hanging/supporting venting, ensure that 1" clearance is maintained on sides and bottom of vent runs and 2" above horizontal vent runs to any combustible material.
- Rigid pipe may be cut less than half way from the **FEMALE END ONLY**.
- Ensure when cutting sections of rigid pipe to maintain integrity of internal supports.
- Flex pipe cannot be cut
- Place the springs, supplied with the pipe kit (flex only), between the outer and inner pipes to keep the pipes separate and avoid any possible hot spots.
- Montigo recommends the use of a flex section for the first section of venting connected directly to the fireplace, offering greater flexibility of installation and absorption of movement.
- Firestops must be installed as required by national & local codes.
- Montigo recommends that all exterior corners and joints be sealed with exterior caulking. However, we encourage you to consult your Building Envelope Engineer or Waterproofing Consultant for further recommendations.

IMPORTANT:

Please refer to your Building Envelope Engineer or Waterproofing Consultant for a review of ALL penetrations through exterior walls or the roof.

DRL
36

DRL
48

DRL
60

DRL
72

4/7 Venting components

Component	Montigo Part Number
Termination	MTO4 (3" Length) MTO4F (3" Length) MTO4FSS
Frame Kits	MSR (Stucco Frame) MOSR (Stucco Frame) BSR-4 (4" Brick Frame) BSR-6 (6" Brick Frame)
Flex Sections	MFL - 1 (12" f/f Connectors) MFL - 18 (18" f/f Section) MFL - 2 (24" f/f Section) MFL - 3 (36" f/f Section) MFL - 4 (48" f/f Section) MFL - 6 (72" f/f Section)
Rigid Pipe	MEXT - 1 (12" f/m Section) MEXT - 2 (24" f/m Section) MEXT - 3 (36" f/m Section) MEXT - 4 (48" f/m Section) MEXT - 6 (72" f/m Section)
Rigid Pipe Extension	EXT18 (18" f/f Section)
Elbows	MEL-90MM (m/m 90° Elbow) MEL-90FF (f/f 90° Elbow) MEL-90FM (f/m 90° Elbow) MEL-45FM (f/m 45° Elbow)
Wall Penetration Kit	MFVK01F
Support Ring & Plate	MSPXT7
Firestop	FS7
Roof Flashing	MRF7 (1/12 - 7/12 pt.) MRF12 (7/12 - 12/12 pt.)
Heat Shield	RHS100
Heat Guard	MTKOG
Adaptors	PVA5487 (5/8 to 4/7 reducer)

5/8 Venting components

Component	Montigo Part Number
Termination	PTO4 (3" Length) PTO4F (3" Length) PVTK1SS (5/8 Vent)
Flex Sections (5/8 Vent)	PFL - 1 (12" f/f Section) PFL - 18 (18" f/f Section) PFL - 2 (24" f/f Section) PFL - 3 (36" f/f Section) PFL - 4 (48" f/f Section) PFL - 6 (72" f/f Section)
Rigid Sections (5/8 Vent)	PEXT - 1 (12" f/m) PEXT - 2 (24" f/m) PEXT - 3 (36" f/m) PEXT - 4 (48" f/m) PEXT - 6 (72" f/m)
Rigid Pipe Extension	PXT12 (12" f/f) PXT20 (20" f/f)
Elbows (5/8 Vent)	PEL-90MM (m/m 90°) PEL-90FF (f/f 90°) PEL-90FM (f/m 90°) PEL-45FM (f/m 45°)
Support Ring & Plate	PSPXT-8
Firestop	FS-8
Roof Flashing	PRF-7 (1/12 - 7/12 pt.) PRF-12 (7/12 - 12/12 pt.)
Heat Shield	RHS101
Vinyl Siding Heat Shield	VSS VSSSS
Storm Collar	SC8
Vertical vent restrictors	PVVR8 PVVR15 PVVR25
Montigo Fireplace Adapter	PVA5487 (5/8 to 4/7 reducer)

The following venting components are approved for use with Montigo products. Please contact your local Montigo dealer for further information.

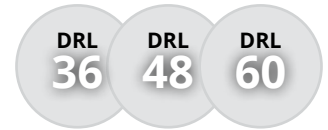

Section 3-3-2.2: 4" x 7" Alternate Venting Components

Component	Montigo P/N	Duravent P/N	MetalFab P/N	Flexmaster P/N
NOTES		Duravent adaptor is designed for collared vent components, Duravent raw flex is true 4/7	For painted black finish add B to the end of part number (i.e. 4D6B)	
Termination	MTO4 (3" Length) MTO4F (3" Length) MTO4FSS	46DVA-HC 46DVA-VCH		
Frame Kits	MSR (Stucco Frame) MOSR (Stucco Frame) BSR-4 (4" Brick Frame) BSR-6 (6" Brick Frame)			
Flex Sections (with collar)	MFL - 1 (12" f/f Connectors) MFL - 18 (18" f/f Section) MFL - 2 (24" f/f Section) MFL - 3 (36" f/f Section) MFL - 4 (48" f/f Section) MFL - 6 (72" f/f Section)	46DVA-36FF (36" F/F Section) 46DVA-60FF (60" F/F Section) 46DVA-120FF (120" F/F Section)		
Flex Sections (Raw, no collar) Duravent adaptor 46DVA-AD-M1 not required when using raw flex		46DVA-36FO (36" Section) 46DVA-60FO (60" Section) 46DVA-120FO (120" Section)		4DVKIT4701 4DVKIT4701.5 4DVKIT4702 4DVKIT4703 4DVKIT4704 4DVKIT4706
Rigid Pipe	MEXT - 1 (12" f/m Section) MEXT - 2 (24" f/m Section) MEXT - 3 (36" f/m Section) MEXT - 4 (48" f/m Section) MEXT - 6 (72" f/m Section)	46DVA-06 (6" Section) 46DVA-09 (9" Section) 46DVA-12 (12" Section) 46DVA-18 (18" Section) 46DVA-24 (24" Section) 46DVA-36 (36" Section) 46DVA-48 (48" Section) 46DVA-60 (60" Section)	4D6 (6") 4D12 (12") 4D18 (18") 4D24 (24") 4D36 (36") 4D48 (48")	
Rigid Pipe Extension	EXT18 (18" f/f Section)	46DVA-08A (8½" Length) 46DVA-16A (16" Length)	4DAL (3" to 10")	
Elbows	MEL-90MM (m/m 90° Elbow) MEL-90FF (f/f 90° Elbow) MEL-90FM (f/m 90° Elbow) MEL-45FM (f/m 45° Elbow)	46DVA-E30 (30° Elbow) 46DVA-E45 (45° Elbow) 46DVA-E60 (60° Elbow) 46DVA-E90 (90° Elbow)	4D45L (45°) 4D90L (90°)	
Wall Penetration Kit	MFVK01F			
Support Ring & Plate	MSPXT7	46DVA-ES (Elbow strap) 46DVA-RS (Roof support)	4DSP	
Firestop	FS7	46DVA-WFS 46DVA-WFS2	4DFS	
Roof Flashing	MRF7 (1/12 - 7/12 pt.) MRF12 (7/12 - 12/12 pt.)	46DVA-F6(DS) (0/12-6/12 pt.) 46DVA-F12(DS) (6/12-12/12 pt.) 46DVA-FF (Flat Roof Flashing)	4DF (1/12 to 5/12) 4DF-12 (6/12 to 12/12) 4DFT (Flat Roof Flashing)	
Storm Collar	SC7		4DSC	
Heat Shield	RHS100	46DVA-WT 46DVA-WTS	4DWT 4DWT11	2DVWTE47
Heat Guard	MTKOG			
Adaptors	DRSQCOL47 (4/7 collar)	46DVA-AD-M1 Mounting Adapter 46DVA-AD-M2 Termination Adapter (Montigo 4/7 to Duravent 4" x 6½")	4DMA Mounting Adapter 4DMTA Termination Adapter	

Section 3-3-2.2: Alternate Venting Components 5"/8"

DRL
72

The following components are approved for use with Montigo products. Please contact your local Montigo dealer for further information.

Component	Montigo P/N	Duravent P/N	ICC P/N	MetalFab P/N	Selkirk P/N	Flexmaster P/N
NOTES		Duravent adaptor is designed for collared vent components, Duravent raw flex is true 5/8				
Termination	PTO4 (3" Length) PTO4F (3" Length) PVTK1SS (5/8 Vent)	58DVA-HC (Horiz. 5/8 vent) 58DVA-VCH (Vert.5/8 Vent)				
Rigid Sections (5/8 Vent)	PEXT - 1 (12" f/m) PEXT - 2 (24" f/m) PEXT - 3 (36" f/m) PEXT - 4 (48" f/m) PEXT - 6 (72" f/m)	58DVA-06 (6") 58DVA-09 (9") 58DVA-12 (12") 58DVA-18 (18") 58DVA-24 (24") 58DVA-36 (36") 58DVA-48 (48") 58DVA-60 (60")	5DL6 (6") 5DL9 (9") 5DL1 (12") 5DL2 (24") 5DL3 (36") 5DL4 (48")	5D6 (6") 5D12 (12") 5D18 (18") 5D24 (24") 5D36 (36") 5D48 (48")	5DT-06 5DT-09 5DT-12 5DT-18 5DT-24 5DT-36 5DT-48	5DVKIT58X01 5DVKIT58X01.5 5DVKIT58X02 5DVKIT58X03 5DVKIT58X04 5DVKIT58X06
Flex Sections (with collar)	PFL1 (12" flex pipe) PFL18 (18" flex pipe) PFL2 (24" flex pipe) PFL3 (36" flex pipe) PFL4 (48" flex pipe) PFL6 (72" flex pipe)	58DVA-36FF (36" F/F Section) 58DVA-60FF (60" F/F Section) 58DVA-120FF (120" F/F Section)				
Flex Sections (Raw, no collar) Duravent adaptor 58DVA-AD-M1 not required when using raw flex		58DVA-36FO (36" Section) 58DVA-60FO (60" Section) 58DVA-120FO (120" Section)				4DVKIT58X01 4DVKIT58X01.5 4DVKIT58X02 4DVKIT58X03 4DVKIT58X04 4DVKIT58X06
Rigid Pipe Extension	PXT12 (12" f/f) PXT20 (20" f/f)	58DVA-08A (12") 58DVA-16A (20")	5DLT (12") 5DSL1 (12") 5DLT2 (20") 5DSL2 (20")	5DAL (3" to 10")	5DT-AJ12 (12")	
Rigid Telescopic Pipe		58DVA-17TA 58DVA-24TA	5DLA30			
Elbows (5/8 Vent)	PEL-90MM (m/m 90°) PEL-90FF (f/f 90°) PEL-90FM (f/m 90°) PEL-45FM (f/m 45°)	58DVA-E30 (30°) 58DVA-E45 (45°) 58DVA-E60 (60°) 58DVA-E90 (90°)	5DE45 (45°) 5DE90 (90°)	5D45L (45°) 5D90L (90°)	5DT-EL45 (45°) 5DT-EL90 (90°)	
Support Ring & Plate	PSPXT-8	58DVA-DC	5CS		5DT-CS	
Firestop	FS-8	58DVA-WFS 58DVA-FS	5CS	5DFS	5DT-FS	
Roof Flashing	PRF-7 (1/12 - 7/12 pt.) PRF-12 (7/12 - 12/12 pt.)	58DVA-FF (flat roof) 58DVA-F6 (0/12 - 6/12 pt.) 58DVA-F12 (7/12 - 12/12 pt.)		5DF (1/12 - 7/12 pt.) 5DF-12 (8/12 - 12/12 pt.)	5DT-AF6 5DT-AF12	
Metal/Tile Roof Flashing		58DVA-F6DS (0/12-6/12 pt.) 58DVA-F12DS (7/12-12/12 pt.)				
Heat Shield	RHS101	58DVA-WTU 58DVA-WT	5WT 5WTE		5DT-WT	2DVWTE58
Attic Radiation Shield		58DVA-IS	5AS 5RDS		5DT-AIS	
Vinyl Siding Heat Shield	VSS VSSSS	58DVA-VSK (Vinyl Siding Standoff)				
Wall Support		58DVA-WS	5WS	5DWS	5DTWSB	
Offset Support		58DVA-ES	5OS		5DT-OS	
Vaulted Ceiling Support		58DVA-CS	5SS	5DRS	5DT-CCS	
Storm Collar	SC8	58DVA-SC	5SC 5SQSC	5DSC	5DT-SC	
Montigo Firepl. Adapter		58DVA-AD-M1	TM-5AA6	5DNA		
Montigo Term. Adapt.		58DVA-AD-M2	TM-5TA1	5DMTA		

Flexmaster as alternate venting

Flexmaster flex venting is approved on all Montigo residential fireplaces. Flexmaster Flex pipe may be used in any length as long as the respective vent graph provided in the manual is adhered to. This approval on Flexmaster Flex includes all and any prepackaged vent kits by Montigo containing Flexmaster venting. All Montigo prepackaged vent kits may be used on any Montigo residential unit fireplace. When using a Power vent you must use Montigo pipe only.

HORIZONTAL FLEX RUN REQUIREMENTS:

Follow venting graph for each model as required. Support horizontal sections every 2ft to prevent sagging, allow for a ¼" rise per foot of horizontal. Use high temperature silicone and three (3) screws at fireplace collar and termination collars. Reduce horizontal run by 36" for each 90° offset after the first one.

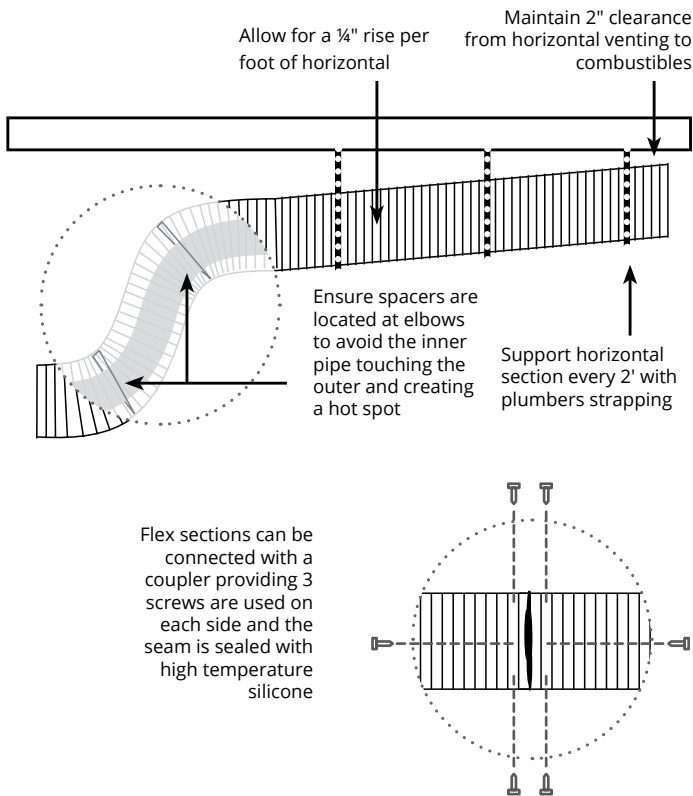

VERTICAL THROUGH THE ROOF:

Follow venting graph for each model as required. Use mil pack and three (3) screws at joints, support horizontal section every 2 ft, use one half of RHS100 as a firestop when passing through floors and ceilings, use additional firestops as necessary to keep construction debris and insulation away from contact with vent.

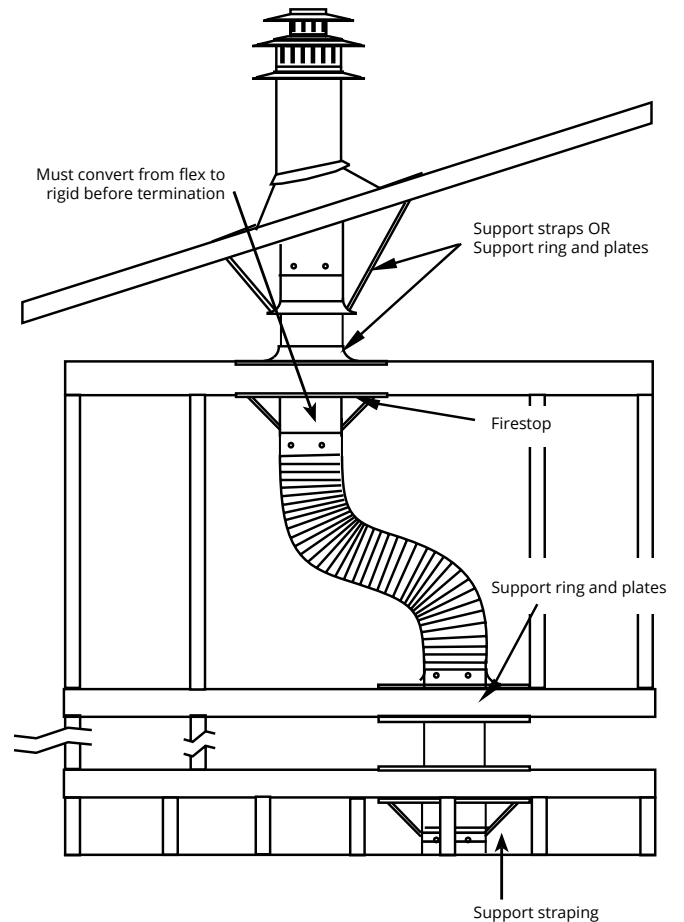

DRL
36

DRL
48

DRL
60

Section 3-3-3: Heat Shields 4"/7"

Installing a Wall Mounted RHS100 Heat shield

Use the RHS100 within 36" horizontal or 60" vertical.

To install the RHS100, Slide the Inner Section over the vent pipe that will connect to the fireplace. Fasten the vent pipe to the back of the fireplace with a Min. of three sheet metal screws.

Next, slide the RHS100 outer section from the outside of the structure.

To complete the installation fasten the Heat Shield Outer Section & Termination frame to the structure.

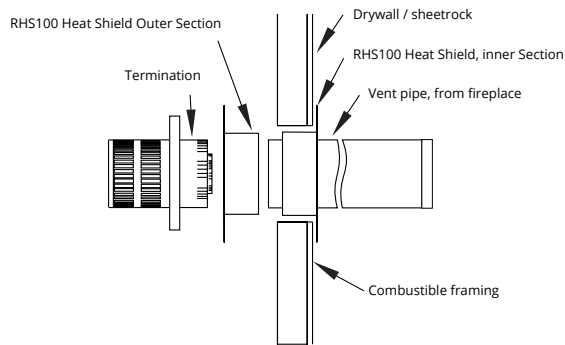

Figure 15.c RHS100 Installation. (Install by sliding Outer Section over vent pipe where it passes through the combustible construction.)

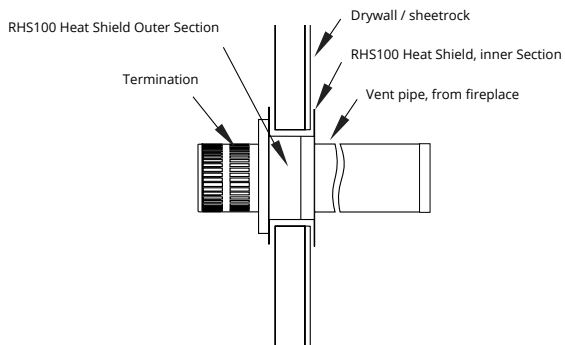

Figure 15.d Heat Shield. After sliding the outer section in place.

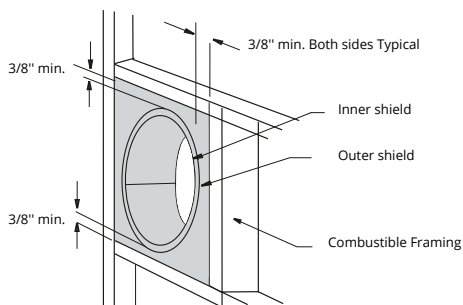

Figure 15.e RHS100 Installation

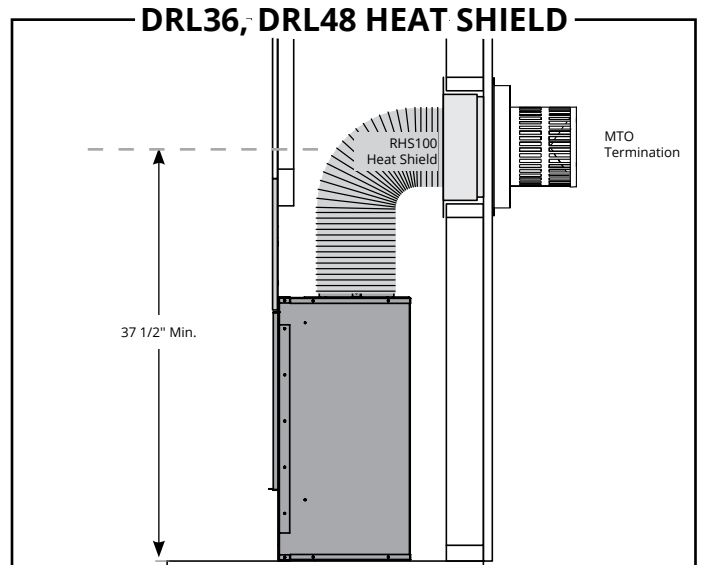

Figure 15.b RHS100 Installation. (Minimum requirements).

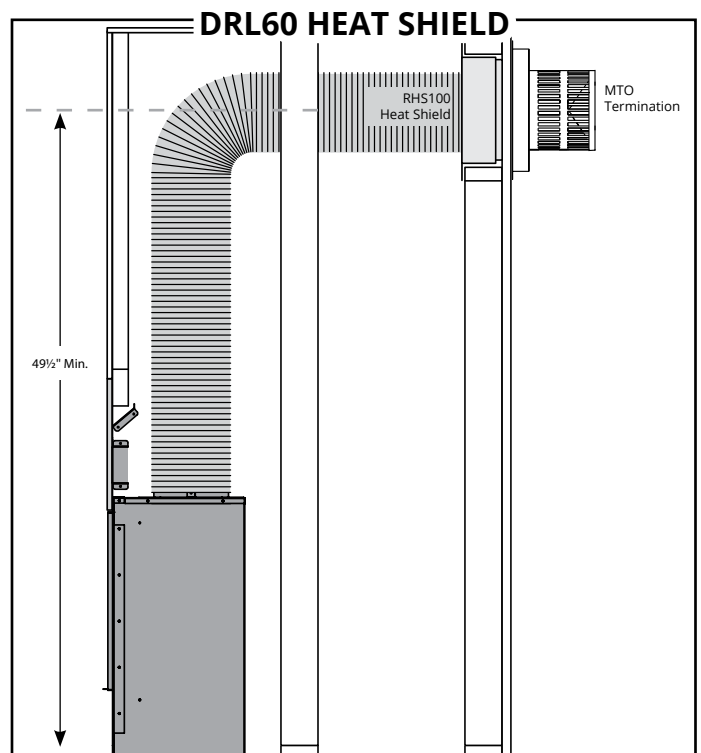

Figure 15.b RHS100 Installation. (Minimum requirements).

Section 3-3-4: Heat Shields 5" / 8"

Installing a Wall Mounted RHS101 Heat shield

Use the RHS101 where any of the dimensions are within the parameters shown, figure 15.d To install the RHS101, Slide the Inner Section over the vent pipe that will connect to the fireplace. Then fasten the vent pipe to the back of the fireplace with a minimum of three sheet metal screws. From the outside slide the RHS101 outer section on see Figure 15.d To complete the installation fasten the heat shield outer section & termination frame to the structure Figure 15.e

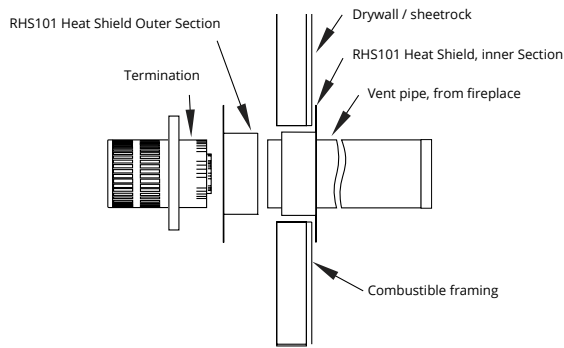

Figure 15.c RHS101 Installation. (Install by sliding Outer Section over vent pipe where it passes through the combustible construction.)

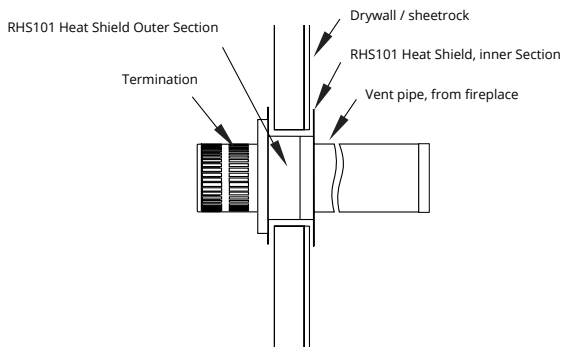

Figure 15.d Heat Shield. After sliding the outer section in place.

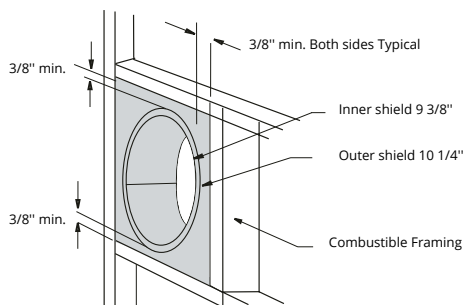

Figure 15.e RHS101 Installation

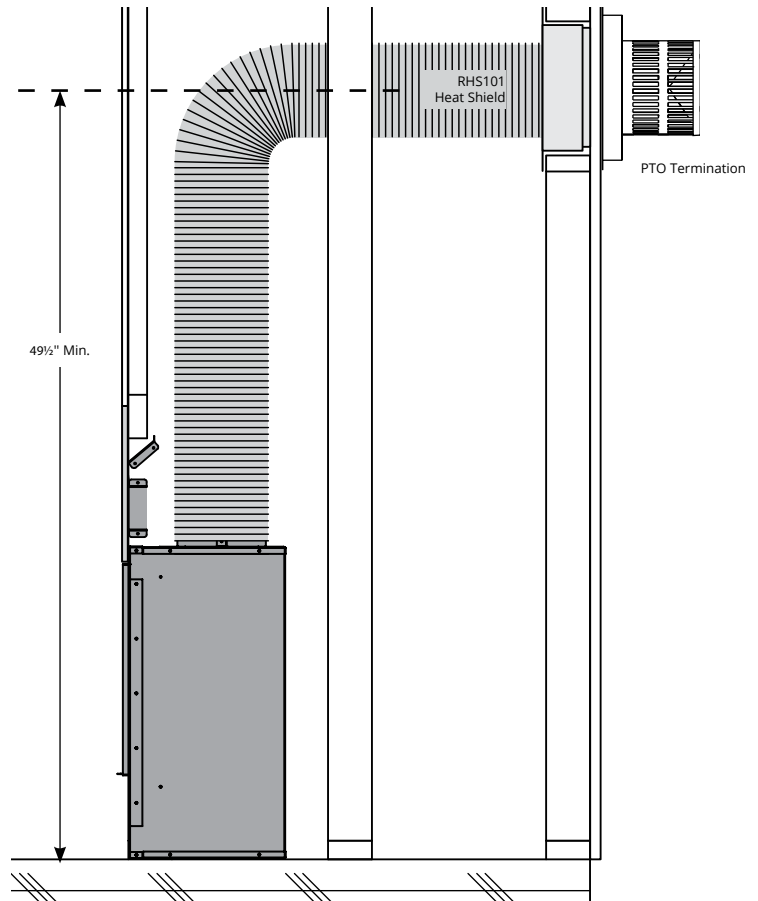
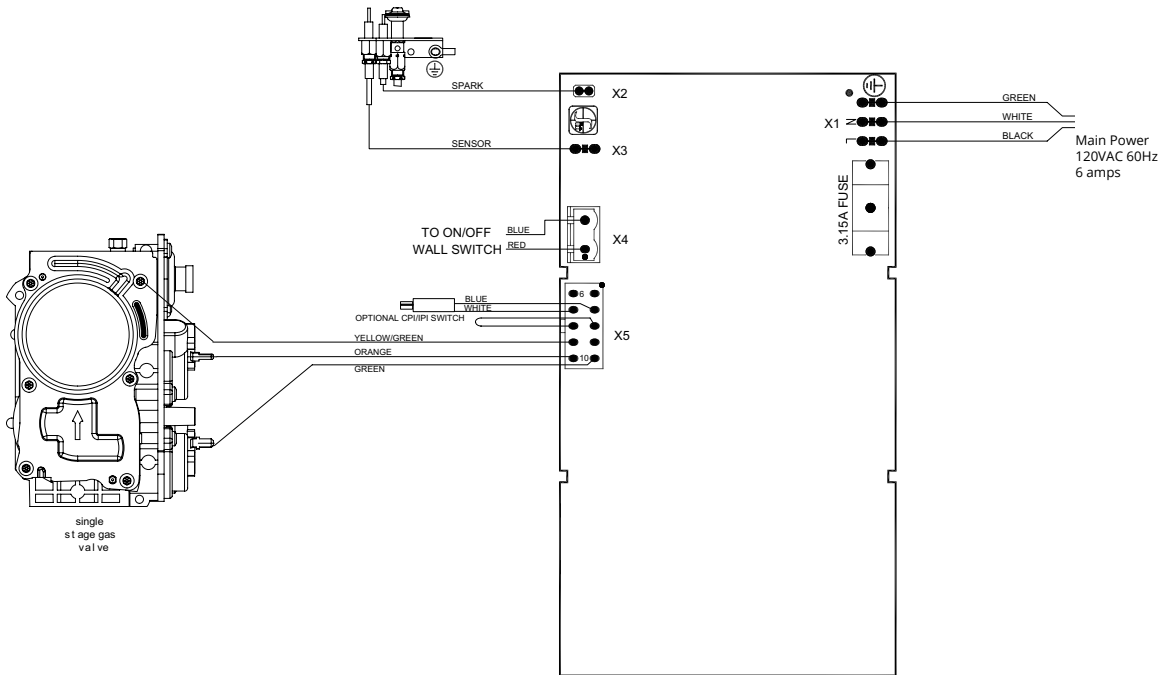

Figure 15.b RHS101 Installation. (Minimum requirements).

Section 4: Wiring

DRL**13 (N/L) I Wiring Diagram



MODEL
DRL3613*I
DRL4813*I
DRL6013*I
DRL7213*I

Figure 15. Wiring diagram for DRL3613NI with SIT Proflame Electronic Ignition

Installation of the wall switch

Montigo supplies 15' of low voltage wire to be plugged into the control board. Connect to a standard single pole ON/OFF switch to the location of your choice. You may extend these wires up to 30' in length with a wire of equal quality.

Installations in Canada must be electrically grounded in accordance with CSA C22.1 Canadian Electrical Code Part 1 and/or Local Codes.

Installations in the USA must be electrically grounded in accordance with local codes or, in the absence of local codes, with the National Electrical Code, ANSI/NFPA 70.

Optional remote control available through your Montigo Dealer.

DRL**13 (N/L) I-2 Wiring Diagram

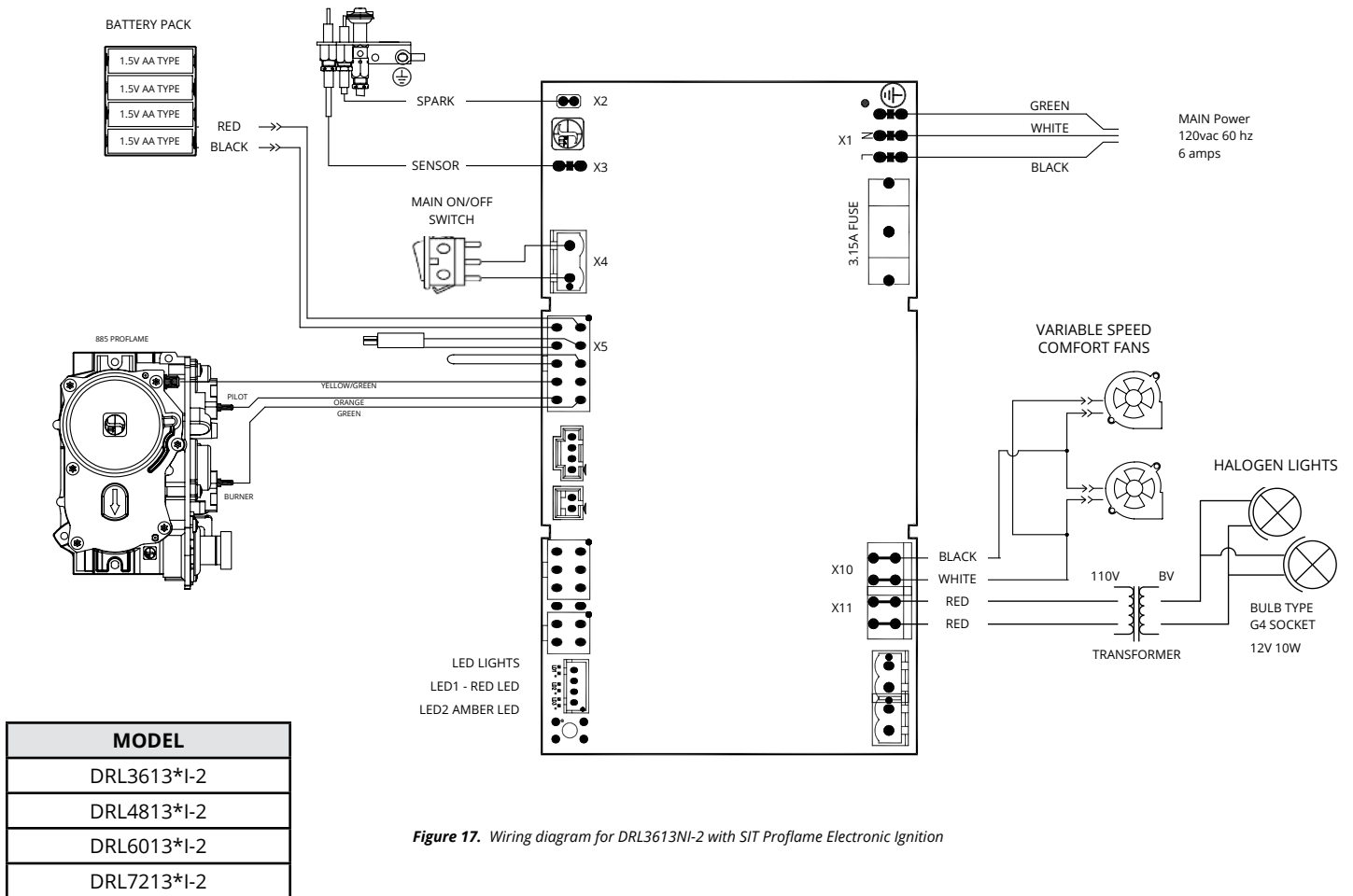

Figure 17. Wiring diagram for DRL3613NI-2 with SIT Proflame Electronic Ignition

Installation of Electrical Supply

Installations in Canada must be electrically grounded in accordance with CSA C22.1 Canadian Electrical Code Part 1 and/or Local Codes.

Installations in the USA must be grounded in accordance with local codes or, in the absence of local codes, with the National Electrical Code, ANSI/NFPA 70.

NOTE: If any of the original wire supplied with the appliance is replaced, it must be replaced with the same type, or its equivalent.

Section 5: Installing the gas line

Fuel Type

- Verify that your fireplace is compatible with your available gas type. (Natural Gas or Propane shown by "N" or "L" in your model number)
- If gas type is not compatible, contact your local Montigo dealer.

Gas Pressure

- Optimum appliance performance requires proper input pressures.
- Gas line sizing requirements will be determined in ANSI Z223.1/NFPA 54 National Fuel Gas Code in the USA and CAN/CGA B149.1 in Canada.

Pressure requirements (during operation):

PRESSURE REQUIREMENTS		
Gas Pressure	Natural Gas	Propane
Minimum inlet pressure	5.5in. w.c.	11in. w.c.
Manifold pressure	3.5in. w.c.	10in. w.c.

Figure 20. Pressure Requirements

- The manifold outlet pressure is set from the factory to the appropriate pressure but should be verified.
- To check pressures, control valves have a provision to remove a 1/8" N.P.T. plug to be fitted with a hose barb.
- Montigo requires a service shut off valve be located in an accessible location to isolate the gas supply.
- Only install gas shut-off valves approved for use by the state, province, or other governing body in which the fireplace is being installed.

Section 5-3: GAS CONNECTION

- See Figure 20.b or 20.c for location of gas line access.
- Flexible gas connectors must not exceed 2 feet in length, unless allowable within local regulations.
- Connect incoming gas line to the 1/2" or 3/8" gas inlet port.
- Check appliance connection, valve and valve train under normal operating pressure with a commercially available leak check solution.

DO NOT USE A FLAME OF ANY KIND TO TEST FOR LEAKS.

NOTICE

When pressure testing the fireplace, gas line, and input system follow the appropriate local codes for your area. DO NOT connect the fireplace to pressures in excess of **0.5 psig. (14" w.c.)** This will damage the gas control valve.

⚠ DANGER

After gas line is connected, each appliance connection, valve and valve train **MUST** be checked while under normal operating pressure with either a Liquid Solution, or Leak Detection Device, to locate any source of leak. Tighten any areas where bubbling appears or a leak is detected until bubbling stops completely or leak is no longer detected. **DO NOT** use a flame of any kind to test for leaks. A fire or explosion will occur, causing serious injury, property damage or death.

⚠ WARNING

An inspection of the explosion relief flappers and door **MUST** be made prior to lighting the fireplace. A faulty seal on the door gasket and/or explosion ports will result in products of combustion leaking into the living space and may result in carbon monoxide poisoning.

Finishing Safety Zone

Take special care when finishing underneath the fireplace door due to the location of the gas valve and control board. Any screw can possibly puncture one of these components resulting in either a non operational unit or worse, a gas leak.

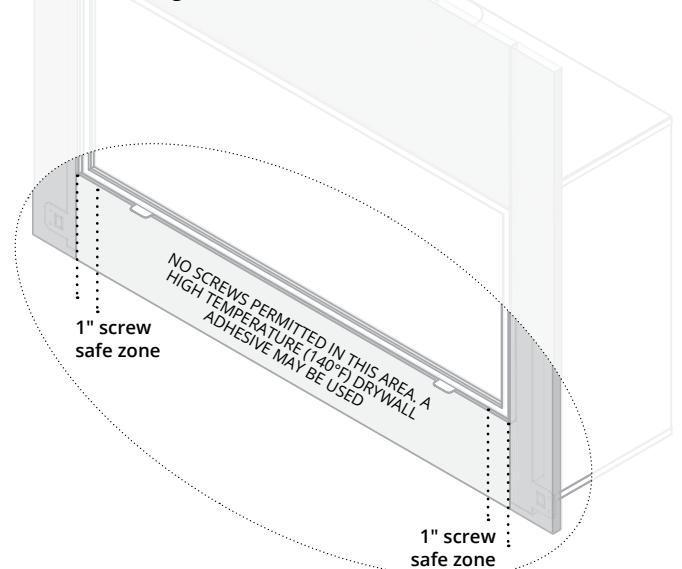

Section 6: Finishing

Finishing Around the Fireplace

Fireplace Facing

When sizing the finish material for your fireplace, it is important to remember the following: THE OPENING MUST NOT BE OBSTRUCTED IN ANYWAY - to do so restricts the air supply for the control compartments and heat exchanger it also prevents access for servicing controls.

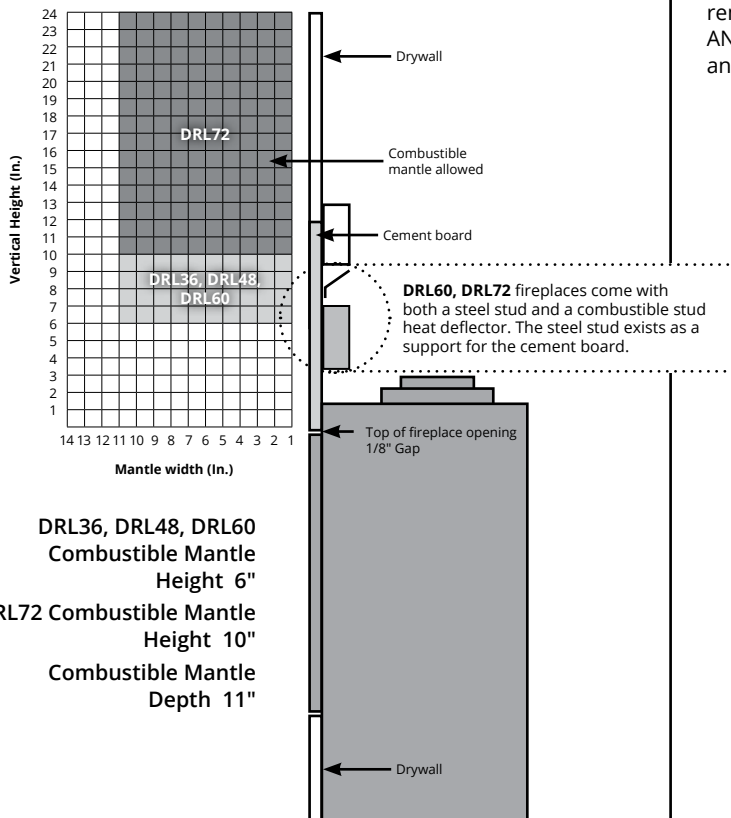

Figure 19. Combustible mantles and facings. (Not to scale)

WARNING

Fireplaces cannot be recessed into a wall cavity.

CAUTION

We recommend careful consideration be given to the effects of elevated mantel temperatures which may be in excess of product design, for example: candles, plastic or pictures. This can cause melting, deformation, discoloration or premature failure of T.V. radio, and other electronic components.

Finishing when using a Cool Wall Advantage kit or vented chase (Cool Wall Release)

Fireplace Facing

When sizing the finish material for your fireplace, it is important to remember the following: THE OPENING MUST NOT BE OBSTRUCTED IN ANYWAY - to do so restricts the air supply for the control compartments and heat exchanger it also prevents access for servicing controls.

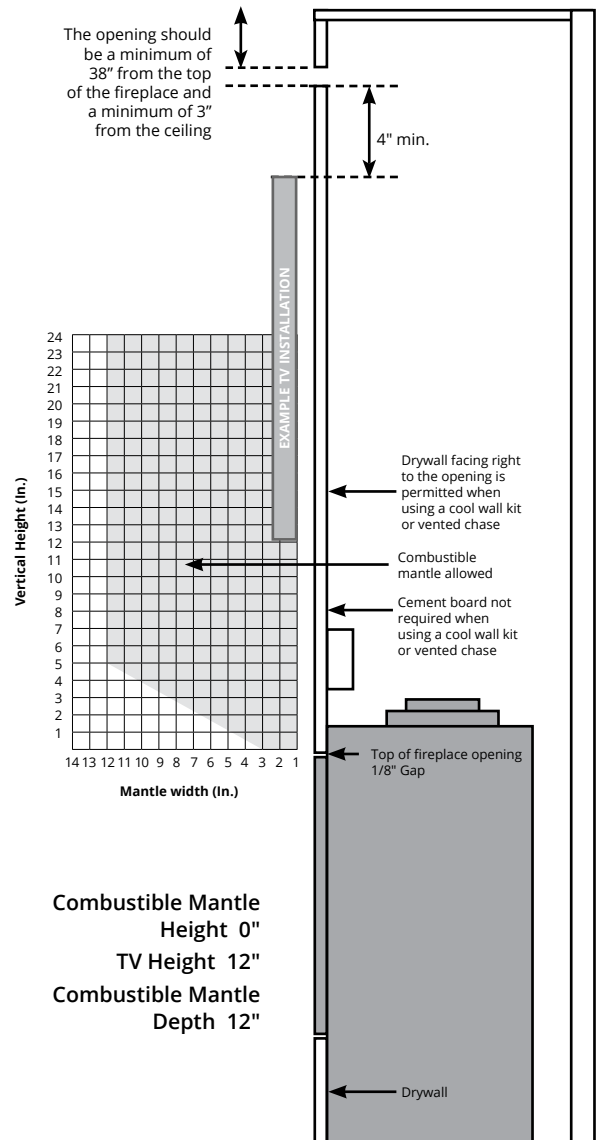

Figure 19. Combustible mantles and facings. (Not to scale)

NOTICE

Cement board is not needed when the chase is vented, drywall can be used to finish up to the fireplace opening.

Chase venting (optional)

An opening in the finished enclosure can keep temperatures within a safe level for a TV installation. This can be achieved in a variety of ways such as the few shown below.

Min. chase opening chart

DRL36	DRL48
70sq inch	100sq inch
DRL60	DRL72
120sq inch	120sq inch

More opening will further reduce surface temperatures

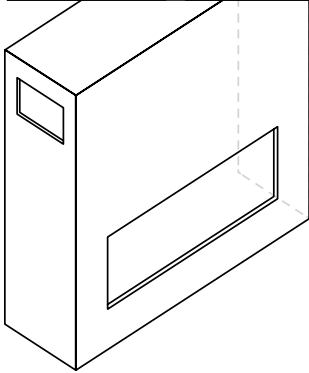

Figure 19.b Side chase venting on both sides of enclosure

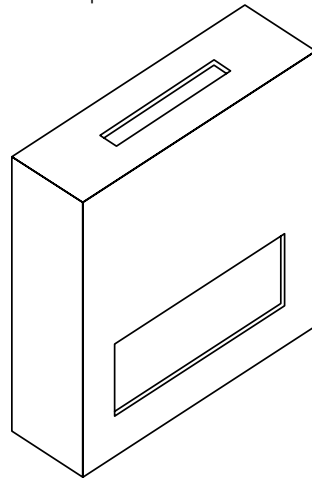

Figure 19.c Top chase venting on top of enclosure

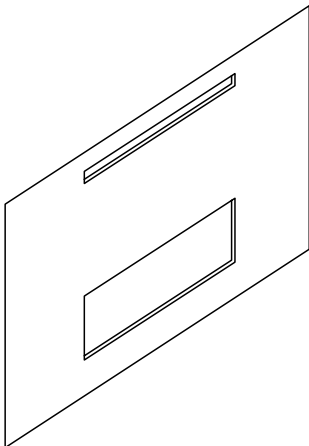

Figure 19.d Front chase venting on front of enclosure

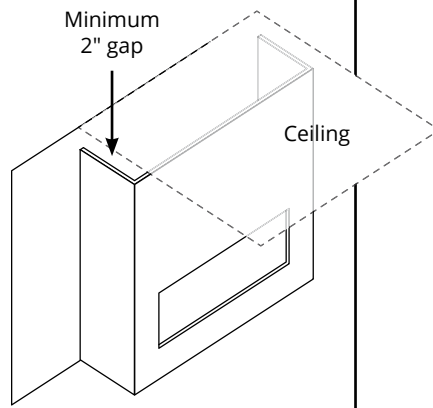

Figure 19.e Open top chase venting on top of enclosure

The opening of the chase cannot be lower than 3" from the top of the enclosure to prevent heat from pocketing at the top of the enclosure. A minimum of 2" from the top of a chase vent to the ceiling is needed. Any combination of the above examples is an acceptable chase vent providing they add up to the required opening.

Sidewall clearances

Side wall clearances are 4". Combustible surrounds may be installed with 4" clearance to the side of the fireplace as shown.

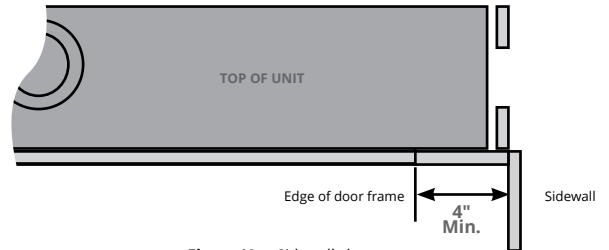

Figure 19.c Sidewall clearances

NOTICE

4" clearance in sidewall drawing does not apply to recession, unit cannot be recessed into a wall.

Cement Board Install

Install the supplied non-combustible cement board to overlap the new horizontal & vertical 2 x 4's, place the non-combustible wall board above the fireplace throat, allowing 1/8" clearance from the rim above the fireplace opening. Pre-drill the board with 1/8" drill bit and secure to framing with nails, use flat head sheet metal screws to fasten the board to the metal header.

SINGLE SIDED

Top (Qty 1)

Sides (Qty 2)

Cut standard Gyproc / Drywall board to complete the installation of the surround. Fit the edge of the board to the rim around the fireplace opening. Fasten the board in place using standard drywall screws.

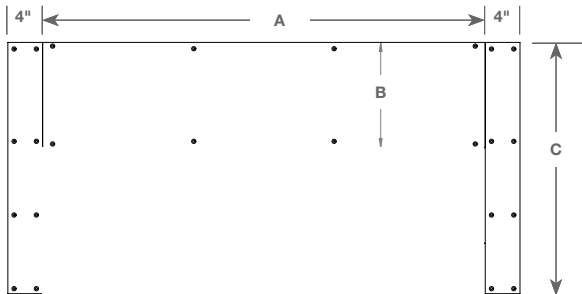

DRL3613 DIMENSIONS

A	B	C
38 ⁷ / ₁₆	12	28 ¹¹ / ₁₆

DRL4813 DIMENSIONS

A	B	C
50 ⁷ / ₁₆	12	28 ¹¹ / ₁₆

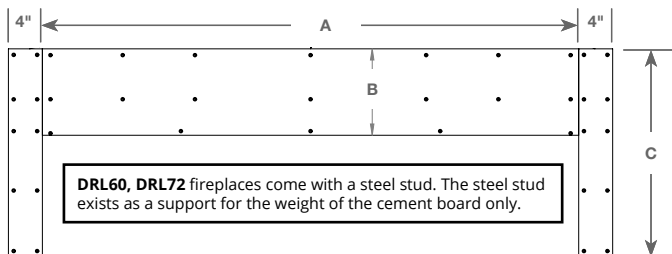

DRL60, DRL72 fireplaces come with a steel stud. The steel stud exists as a support for the weight of the cement board only.

DRL6013 DIMENSIONS

A	B	C
62 ⁷ / ₁₆	16	32 ¹¹ / ₁₆

DRL7213 DIMENSIONS

A	B	C
83 ⁷ / ₁₆	12	28 ¹¹ / ₁₆

Figure 28. Supplied non-combustible cement board dimensions

⚠ WARNING

The use of the fans when the Cool Wall Release OR Cool Wall Advantage system is used will result in significantly higher wall temperatures. These higher temperatures can negatively impact the finished wall surface, art, and or mounted TV. Therefore, Montigo **STRONGLY RECOMMENDS** that fans be disconnected when the Cool Wall Release OR Cool Wall Advantage system is used. This can be done through the remote control (See instructions) or by disconnecting the fan harness. Montigo is **NOT** responsible for damage to facing materials, and items placed above the fireplace (eg. TV, artwork)

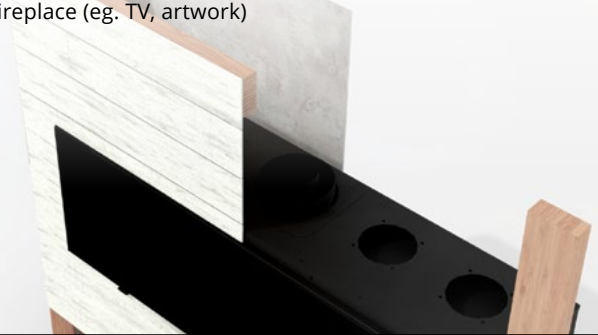

FULL LOAD VERSIONS:

Disable fans via remote

1. Turn the fireplace on, turn fans to off setting.
2. Partially take out one battery.
3. Hold both the Mode AND On/Off button.
4. Insert battery (while still holding the two buttons), then release Mode button (keep On/Off pressed).
5. Cycle through modes with Mode button until you get to fan setting, with Down button set fan function from Set to Clr.
6. Release On/Off button, turn the fireplace on. There will be now be no fan mode on remote.

BASIC VERSIONS (IF OPTIONAL FAN KIT ALREADY INSTALLED):

Disable fans via harness

1. Unplug the fan harness that connects power to the speed control.



Section 8: Removing & Installing the Screen / Door

Removing the Screen

Follow the steps below to remove, or install the fireplace screen and door. Before beginning any screen or glass removal, make sure that the unit has not been in operation and that it is at room temperature.

Step 1: Locate the three tabs at the base of the screen.

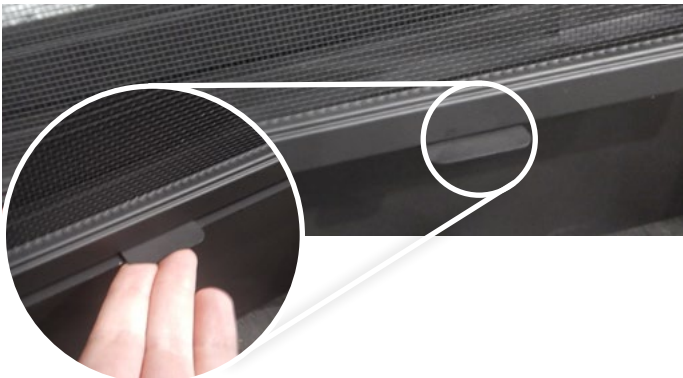

Figure 20. Locate the three tabs at the base of the screen

Step 2: Lift out the Retaining Tabs and screen.

Pull the bottom of the screen outward, then slide out the screen from the frame.

Store in a safe place. The Screen is very fragile and can be easily torn, dented or deformed. Refer to Figure 20.b below.

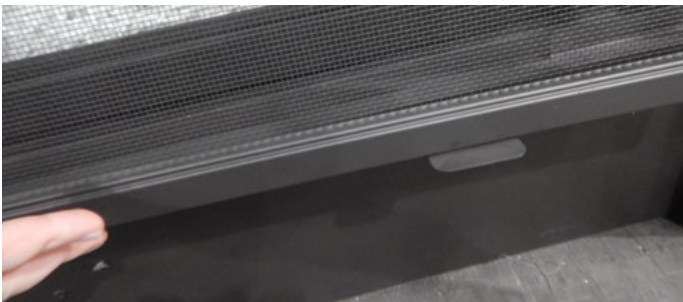

Figure 20.b Lift out the Retaining Tabs and screen

Reinstalling the Screen

Follow the two previous steps to re-install the fireplace window.

NOTICE

Any safety screen, guard, or barrier removed for servicing an appliance, must be replaced prior to operating the appliance

Removing the door

The door is removed in a few simple steps. Follow these steps below to unlatch the door buckles and remove the door.

STEP 1:

Remove lower valve blinds and screen setting bar.

STEP 2:

Ensure the tool is firmly in the lower end of the slot, (as shown), Then pull toward you, door will unlatch, repeat for other buckles.



Figure 21.d Pull door latches

STEP 3:

Pull the top of the door towards you, then lift the door up and out of the fireplace frame.

Store in a safe place.

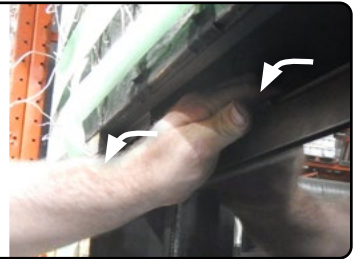

Figure 21.e Lift the door

Reinstalling the door

NOTE: Make sure the top and base of the door slips into the narrow channel in the frame to ensure proper placement.

STEP 1:

Line up the notch of the bottom of the door with the tab on the door channel.



Figure 21.b Installing the door

STEP 2:

Buckles are locked into place by pulling out and up, latch will pop into place.

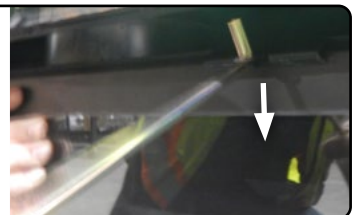
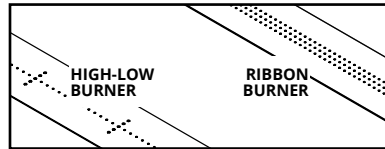

Figure 21.d Pull door latches



Gas conversion steps vary based on what burner the unit is installed in the fireplace. Check the burner hole pattern to ensure you are using the right instructions.

Propane Conversion (High-Low Burner)

To convert the DelRay from Natural Gas to Propane, install the conversion kit listed in the table below. The unit must be disconnected from any gas supply, disconnected from any electrical supply and batteries.

Tools required

- 1). Torx T20 Screw Driver Bit
- 2). 1/2" Socket Driver
- 3). 5/32" Allen Key
- 4). Needle Nose Pliers or Small Flat Head Screw Driver
- 2). 1/4" Socket Driver

Parts included

- 1). Propane burner orifice
- 2). Propane pilot orifice
- 3). Propane valve control (with mounting screws)
- 4). Valve conversion label
- 5). Conversion plate label
- 6). Conversion technician identifying label

For input rating, manifold pressure and orifice size, refer to sample rating plate

NG to LP Conversion Kits				
	36	48	60	72
Basic	GCA010	GCA019	GCA047	GCA052
Fully Loaded	GCA010	GCA019	GCA048	GCA053

⚠ WARNING

This conversion kit shall be installed by a qualified gas fitter in accordance with the manufacturer's instructions and all applicable codes and requirements of the authority having jurisdiction. If the information in these instructions is not followed exactly, a fire, explosion or production of carbon monoxide may result causing property damage, personal injury or loss of life. The qualified service agency is responsible for the proper installation of this kit. The installation is not proper and complete until the operation of the converted appliance is checked as specified in the manufacturer's instructions supplied with the kit.

⚠ CAUTION

The gas supply shall be shut off prior to disconnecting the electrical power, before proceeding with the conversion.

1. Shut off gas supply.

2. Remove the 2 screws securing the pilot cover to the media tray. Remove 2 screws on burner clamp.

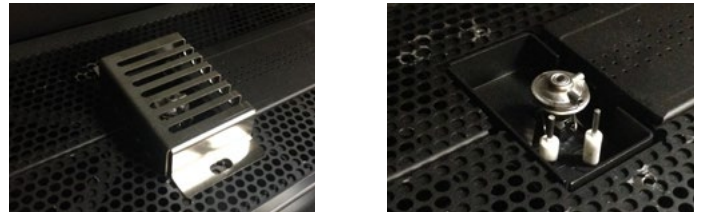

Figure 13. Removal of pilot cover

3. Burner can now be removed.



Figure 13.b Loosening the venturi

4. Use 1/2" Socket Driver to loosen off the NG gas orifice, replace with Propane orifice as included in package.

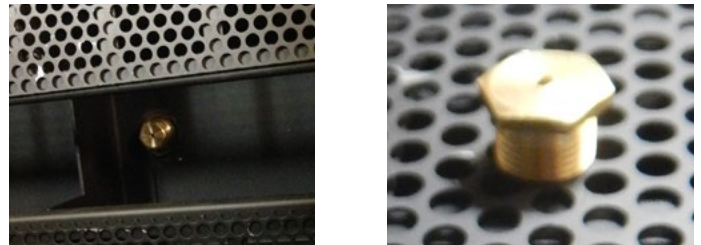

Figure 13.c Removing the orifice

5. Adjust the mixer to fully open. If converting from LP to NG, then slide the sleeve until only a 1/8th gap is exposed.

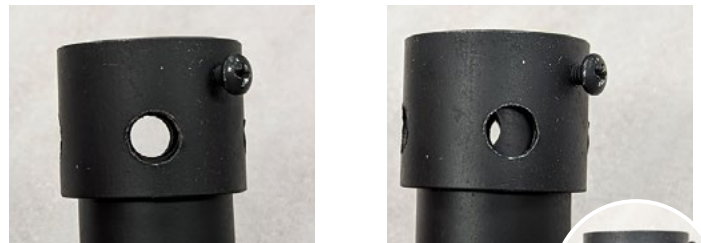

Figure 13.c Adjusting the orifice

TIP: Use a 1/8th drill bit to easily measure the opening needed for natural gas.



6. Use screwdriver to carefully detach spring clip from the pilot hood. (Spring clip will be reused)

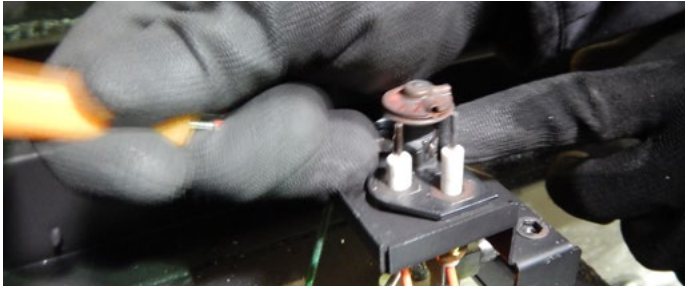

Figure 13.d Removing the spring clip

7. Remove pilot hood, then use allen key to remove pilot orifice.

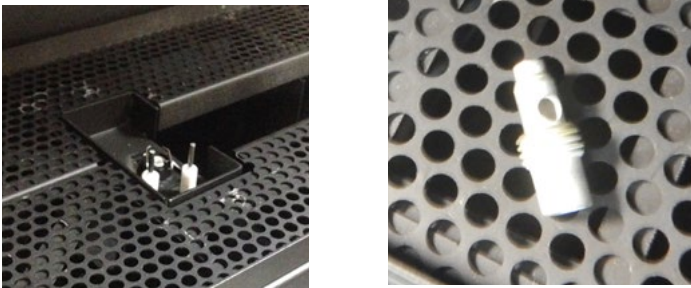

Figure 13.e Removing the pilot hood, orifice

8. Insert Propane pilot orifice. Reassemble pilot assembly and hood.

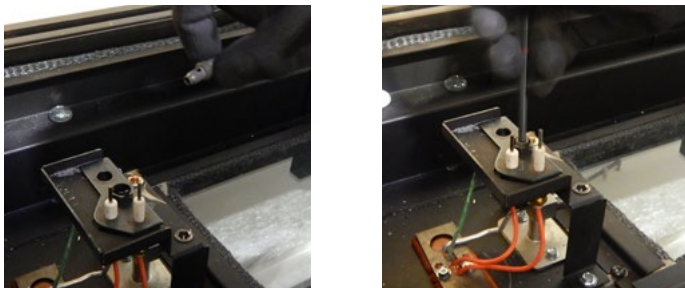

Figure 13.f Insert propane orifice, reassemble burner

9. See regulator instructions for guide on converting the pressure regulator gasket.



10. The pilot size can be adjusted using a flathead screwdriver to adjust "pilADJ" screw shown

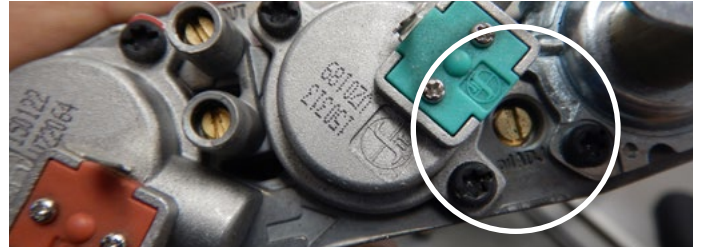

Figure 13.g Adjust pilot size

11. The manifold and inlet pressure can be verified by using a manometer and a 1/8" rubber hose attached to the valve ports shown here (top is manifold, bottom is inlet) Use a soap-based leak testing solution on the valve regulator while the unit is operating to check for any leaks

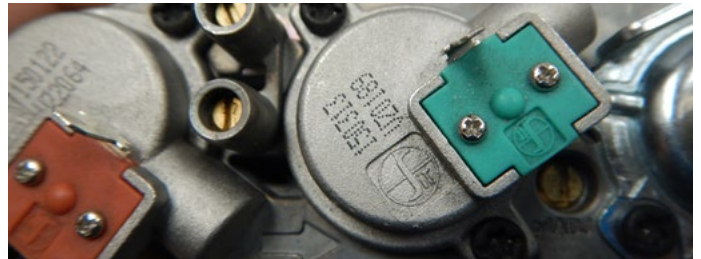

Figure 13.h Adjust pressure ports

12. Fill out required information on Propane conversion gas fitter sign off label, attach to reverse side of rating plate. Attach Rating plate conversion label to rating plate label. Place Valve conversion label on valve face.

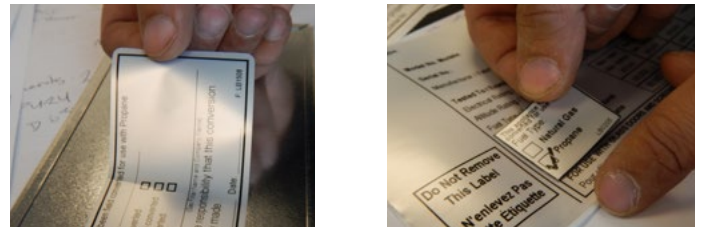

Figure 13.i Label reverse rating plate



Figure 13.k Conversion label on valve

Stepper motor install/replace (If equipped)

Verify that the following items are present in the package.

- Pressure regulator assembly (E)
- Two (2) screws (F)
- Identification label (G)
- Installation instructions

- 1 Shut off the gas supply to the valve and shut down the electric supply
- 2 Using a Torx T20, or slotted screwdriver, remove and discard the two (2) pressure regulator mounting screws (A), pressure regulator tower (B), and the spring and diaphragm assembly (C), (If applicable).
- 3 Access gas valve by removing the valve blind
- 4 Ensure the rubber gasket (D), which is prefitted as part of assembly (E), is properly positioned, otherwise fit the gasket as shown.
- 5 Install the new STEPPER MOTOR pressure regulator assembly, as shown in Fig. 3 and Fig. 4. Use the supplied screws (F)
- 6 Manually thread the two conversion kit mounting screws into the valve body. Use a standard screwdriver or T20 Torx bit and tighten to the screws with a fixing torque of 251b-in \pm 5%.

IN THE EVENT THAT THE THREADS OF THE VALVE ARE STRIPPED OR DAMAGED, REPLACE THE VALVE.

- 7 Install the enclosed identification label (G) to the valve body where it can be easily seen.
- 8 Make STEPPER MOTOR and valve electrical connections, apply gas to system and relight appliance according to manufacturers instructions.
- 9 With the main burner "ON", test the new pressure regulator assembly for leaks using a soap solution.
- 9 Relight the main burner and verify proper burner ignition and operation

WARNING!

Do not use power drill.

WARNING!

Installation should be carried out in a clean environment.

WARNING!

This modulating conversion kit must ONLY be applied as part of a conversion kit supplied by montigo for the specific appliance, and type of fuel, being converted.

WARNING!

Correct operation of the system cannot be guaranteed if the conversion kit or valve has been dropped or has sustained a strong impact.

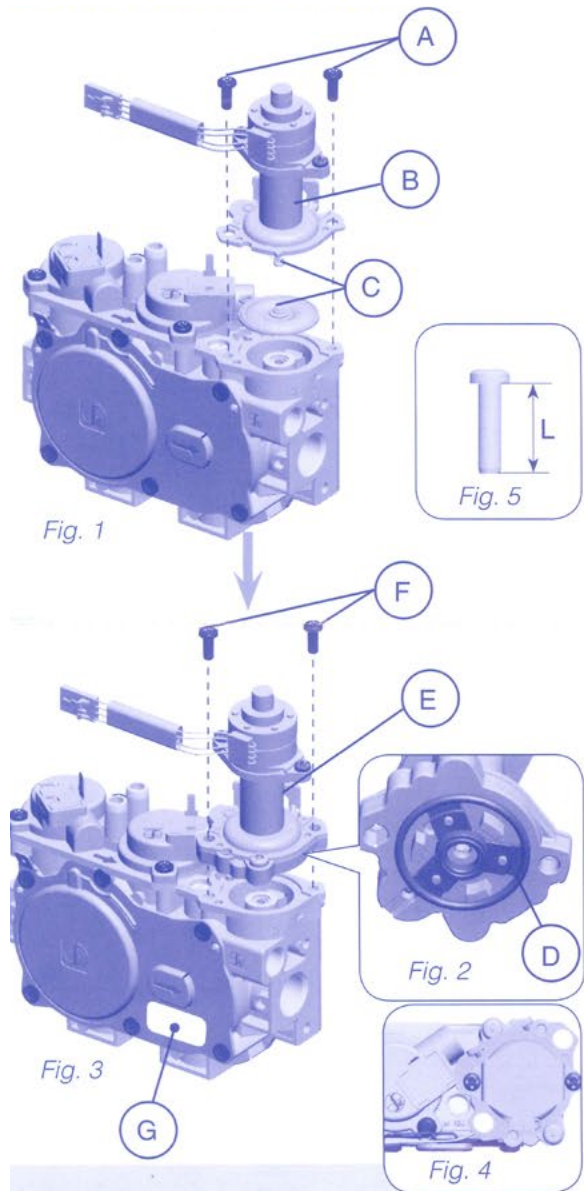

<p>HIGH-LOW BURNER RIBBON BURNER</p>	<p>Gas conversion steps vary based on what burner the unit is installed in the fireplace. Check the burner hole pattern to ensure you are using the right instructions.</p>
---	---

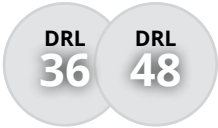

Propane Conversion (Ribbon Burner)

To convert the DelRay from Natural Gas to Propane, install the conversion kit listed in the table below. The unit must be disconnected from any gas supply, disconnected from any electrical supply and batteries.

Tools required

- 1). Torx T20 Screw Driver Bit
- 2). 1/2" Socket Driver
- 3). 5/32" Allen Key
- 4). Needle Nose Pliers or Small Flat Head Screw Driver
- 2). 1/4" Socket Driver

Parts included

- 1). Propane burner orifice
- 2). Propane pilot orifice
- 3). Propane valve control (with mounting screws)
- 4). Valve conversion label
- 5). Conversion plate label
- 6). Conversion technician identifying label

For input rating, manifold pressure and orifice size, refer to sample rating plate

NG to LP Conversion Kits		
	36	48
Basic	GCA010	GCA019
Fully Loaded	GCA010	GCA019

1. Shut off gas supply.

2. Remove the 2 screws securing the pilot cover to the media tray. Remove 2 screws on burner clamp.

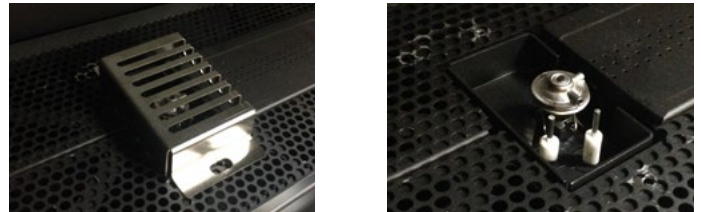

Figure 13. Removal of pilot cover

3. Burner can now be removed.



Figure 13.b Loosening the venturi

4. Use 1/2" Socket Driver to loosen off the NG gas orifice, replace with Propane orifice as included in package.

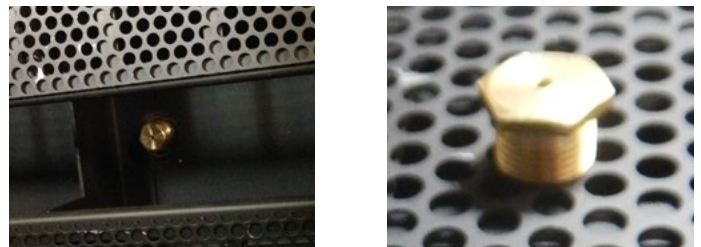

Figure 13.c Removing the orifice

5. Remove natural gas mixer sleeve from burner. Reinstall burner



Figure 13.c Removing the orifice

WARNING

This conversion kit shall be installed by a qualified gas fitter in accordance with the manufacturer's instructions and all applicable codes and requirements of the authority having jurisdiction. If the information in these instructions is not followed exactly, a fire, explosion or production of carbon monoxide may result causing property damage, personal injury or loss of life. The qualified service agency is responsible for the proper installation of this kit. The installation is not proper and complete until the operation of the converted appliance is checked as specified in the manufacturer's instructions supplied with the kit.

CAUTION

The gas supply shall be shut off prior to disconnecting the electrical power, before proceeding with the conversion.

6. Use screwdriver to carefully detach spring clip from the pilot hood. (Spring clip will be reused)



Figure 13.d Removing the spring clip

7. Remove pilot hood, then use allen key to remove pilot orifice.

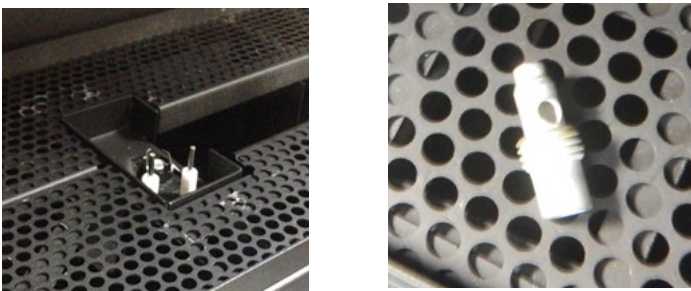

Figure 13.e Removing the pilot hood, orifice

8. Insert Propane pilot orifice. Reassemble pilot assembly and hood.

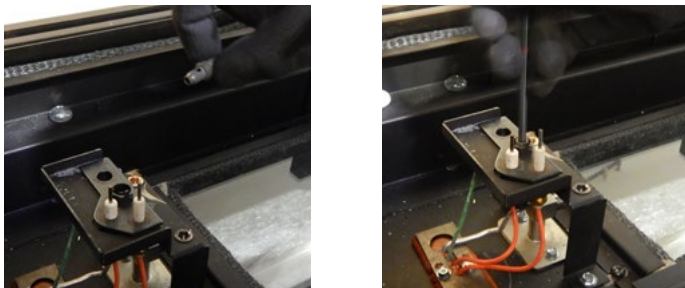

Figure 13.f Insert propane orifice, reassemble burner

9. See regulator instructions for guide on converting the pressure regulator gasket.



10. The pilot size can be adjusted using a flathead screwdriver to adjust "pilADJ" screw shown

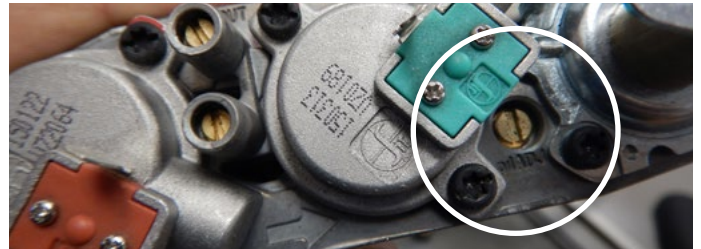

Figure 13.g Adjust pilot size

11. The manifold and inlet pressure can be verified by using a manometer and a 1/8" rubber hose attached to the valve ports shown here (top is manifold, bottom is inlet) Use a soap-based leak testing solution on the valve regulator while the unit is operating to check for any leaks

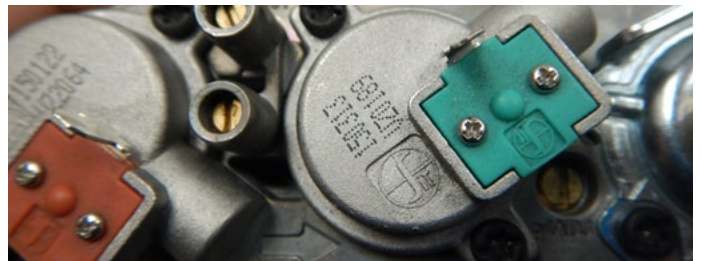

Figure 13.h Adjust pressure ports

12. Fill out required information on Propane conversion gas fitter sign off label, attach to reverse side of rating plate. Attach Rating plate conversion label to rating plate label. Place Valve conversion label on valve face.

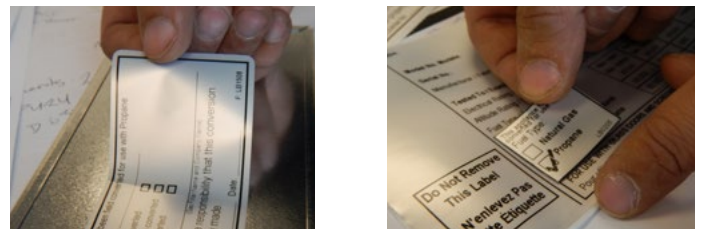

Figure 13.i Label reverse rating plate



Figure 13.k Conversion label on valve

Section 9: Installing the Accessories

Installing the Fireglass or Optional Glass Media

The unit is supplied with fireglass. Optional fireglass may be purchased from the dealer. Remove the Door as shown in the previous Instruction. Once the glass door is removed place the firestones randomly across the pan and the burners.

Note: Only cover the burner with one layer of firestones or fireglass.



Figure 24.b Completed firestone installation

DelRay 36" Optional Log Kit Installation

The Fireplace has the option of installing a drift wood log set. Once the base media of fireglass, firestones, or speckled stones has been placed the log set can be installed. Ensure logs are securely placed and will not tip or fall.

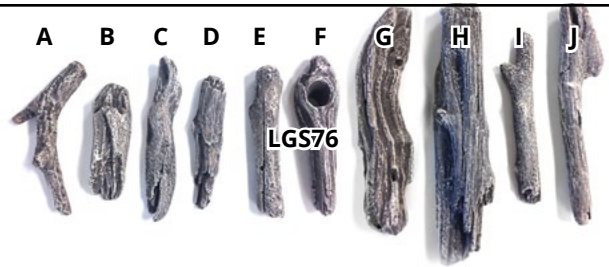

Driftwood Layout

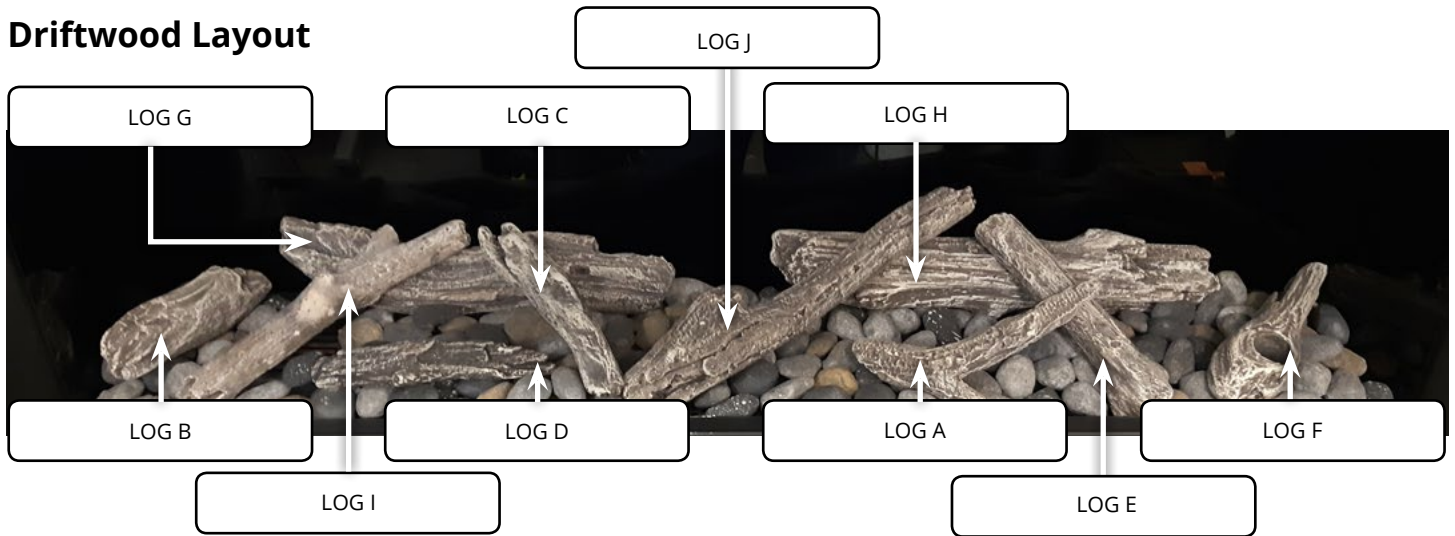

DelRay 48" Optional Log Kit Installation

The Fireplace has the option of installing a drift wood log set. Once the base media of fireglass, firestones, or speckled stones has been placed the log set can be installed. Ensure logs are securely placed and will not tip or fall.

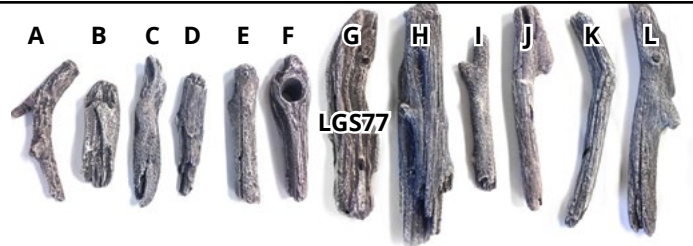

Driftwood Layout

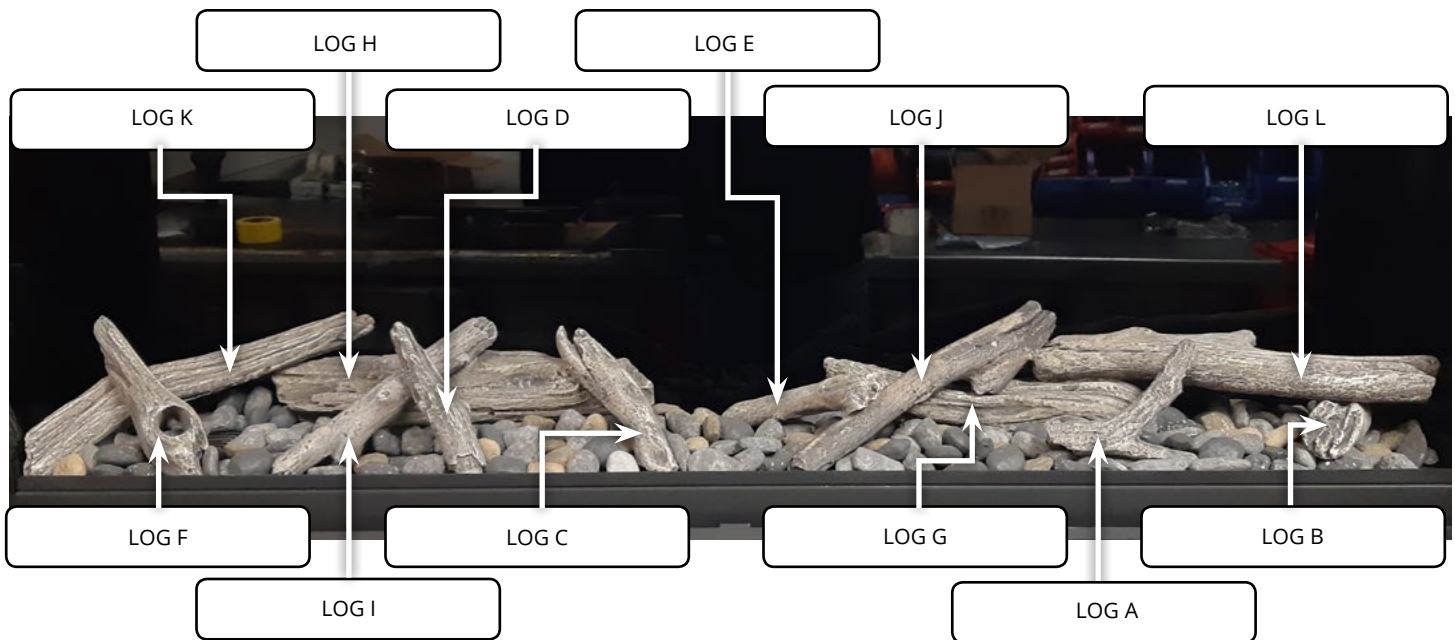

Installation



DelRay 60" Optional Log Kit Installation

The Fireplace has the option of installing a drift wood log set. Once the base media of fireglass, firestones, or speckled stones has been placed the log set can be installed. Ensure logs are securely placed and will not tip or fall.

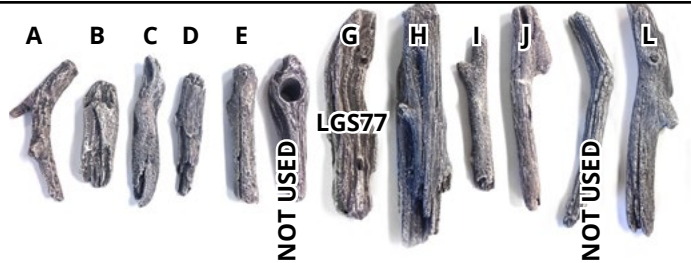

Driftwood Layout

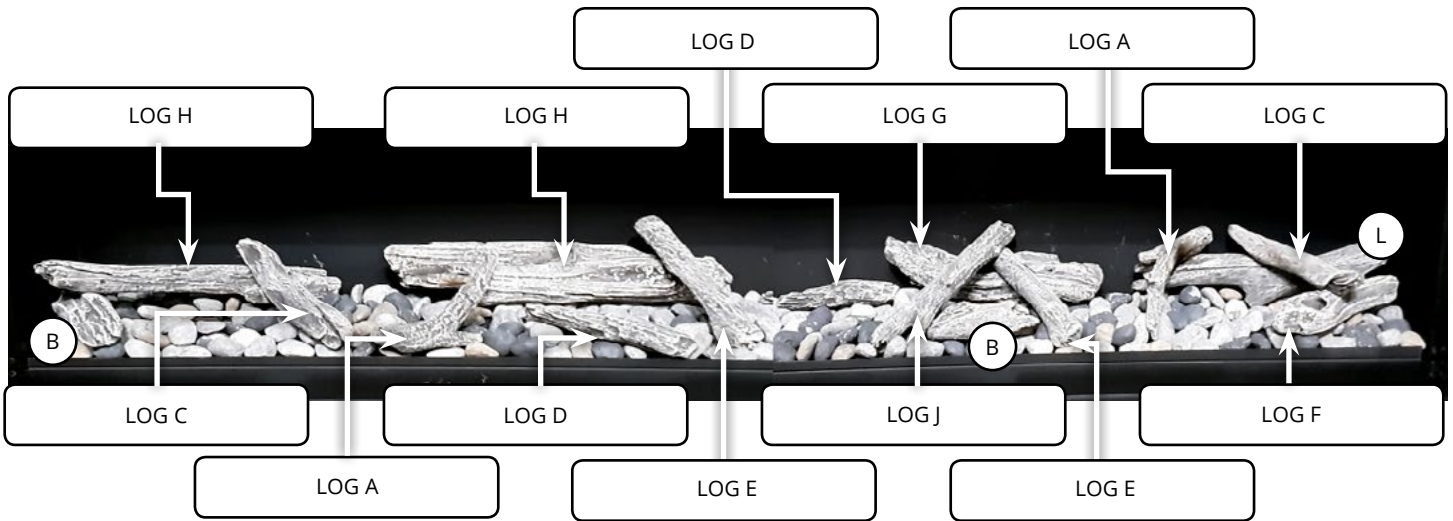

Installation



DelRay 72" Optional Log Kit Installation

The Fireplace has the option of installing a drift wood log set. Once the base media of fireglass, firestones, or speckled stones has been placed the log set can be installed. Ensure logs are securely placed and will not tip or fall.

Driftwood Layout

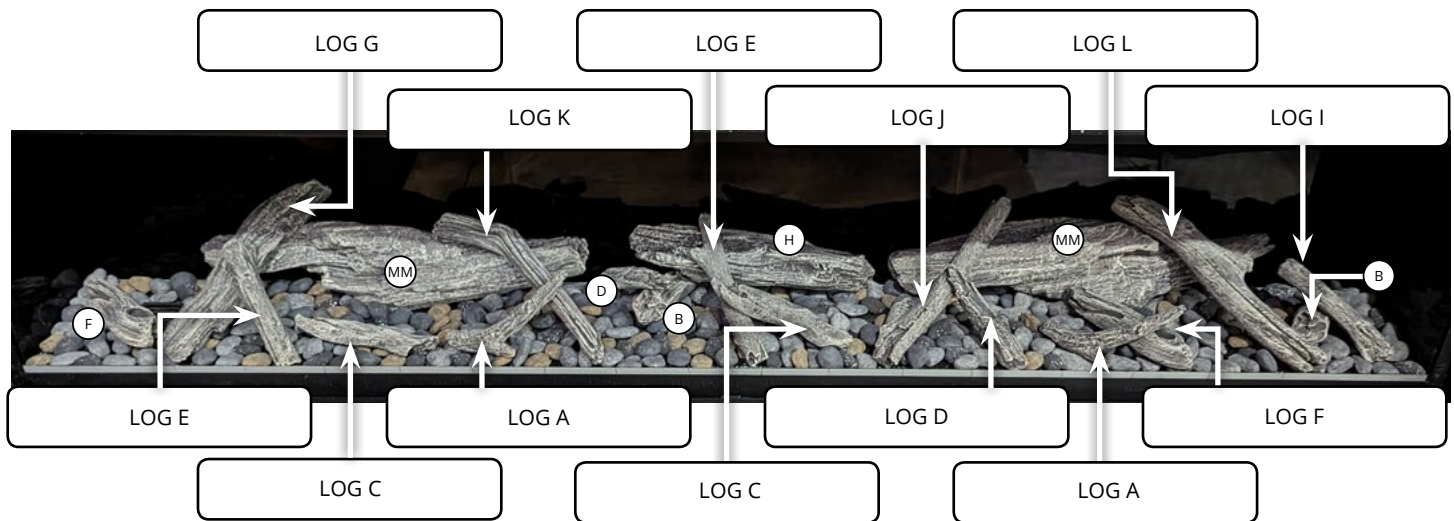

Remote Operation (Full Load Units)

The Proflame 2 System consists of the following elements:

1. Pilot Assembly
2. Proflame Gas Valve.
3. Proflame 2 Control Module
4. Wiring Harness
5. Variable Speed fans
6. Downlighting
7. Proflame 2 remote control
8. Battery Pack
- 9 Manual override switch

NOTE: Can not be used with home automation systems.

The Proflame 2 Transmitter controls the following fireplace functions:

1. Main Burner On/Off
2. Main Burner flame modulation (6 levels).
3. Choice of standing or intermittent pilot (CPI/IPI).
4. Thermostat and Smart thermostat functions.
5. Lights
6. Fan speed modulation (6 levels).

The Proflame 2 Transmitter uses a streamlined design with a simple button layout and informative LCD display. A Mode Key is provided to index between the features and a Thermostat Key is used to turn On/Off or index through Thermostat functions, see Figure 26. Additionally, a Key Lock feature is provided.



Figure 29. Proflame 2 Remote

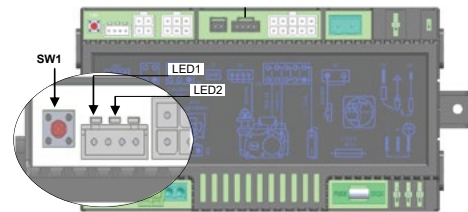

- SW1 = Programing Button
- LED1 = Red Diagnostic Light
- LED2 = Amber Programing Remote Control Light

Figure 29.b Proflame 2 Control Module

⚠ WARNING

Do not expose remote control to temperatures below 0°C (32°F) or above 50°C (122°F)

⚠ CAUTION

Property Damage Hazard. Excessive heat can cause property damage.
The appliance can stay lit for many hours. Turn off the appliance if it is not going to be attended for any length of time.

⚠ WARNING

Battery operated device. Read the battery instructions before installing them into the system. Do not expose any battery, or its holder, or a device in which batteries are installed, to a working temperature greater than 54°C / 129°F

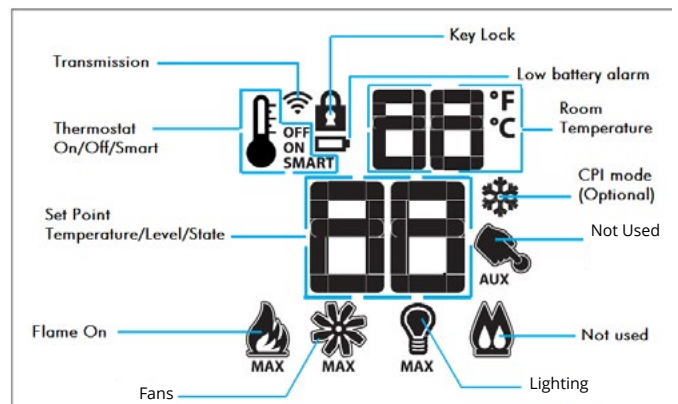

Figure 29.c Remote Control LCD Display

Initializing the System for the first time

1. Set master override switch to off position.
2. Install four (4) AA batteries into the battery holder.
3. Install three (3) AAA batteries in the back of the remote control. Note the polarity of batteries and install them as indicated by the silk screen (+/-) on the holder.
4. Connect AC Power (115 volts, 60 Hz) to fireplace.

Operating the System for the first time

Press SW1 button on the control module. The control module will beep three (3) times and an amber LED is illuminated to indicate that the IFC (control board) is ready to synchronize with a remote control within 10 sec. Push the ON button. The control module will "beep" four (4) times to indicate transmitter's command is accepted.

The System is now initialized.

Temperature Indication Display

With the system in the "Off" position, press the Thermostat Key and the Mode Key at the same time. Look at the LCD screen on the Remote Control to verify that a C or F is visible to the right of the Room Temperature display.

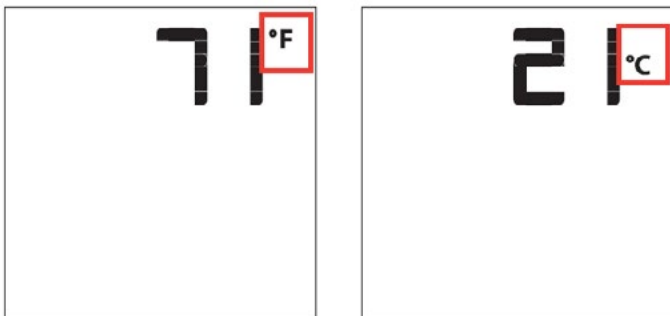

Figure 27.e Remote Control display in Fahrenheit & Celsius

Turn On the Fireplace

With the system Off, turn the master override switch to on and press the On/Off Key on the Remote Control. The Remote Control display will show some other active Icons on the screen. At the same time the Control Module will activate the fireplace. A single "beep" from the Control Module will confirm reception of the command.

Turn Off the Fireplace

With the system On, press the On/Off Key on the Remote Control. The Remote Control LCD display will only show the room temperature. At the same time the Control Module will turn off the fireplace. A single "beep" from the Receiver confirms reception of the command.



Figure 27.f Remote Control Display

Remote-Flame Control

When you turn on the fireplace it starts on high. The proflame 2 has six (6) flame levels. Each time you press the Down Arrow Key once the flame height will reduce by one step.

You can continue this until the main burner flame turns off. You can still operate the accent lights and fans in this mode.

If the main burner flame is off and you press the up arrow key once, the flame will automatically go to high.

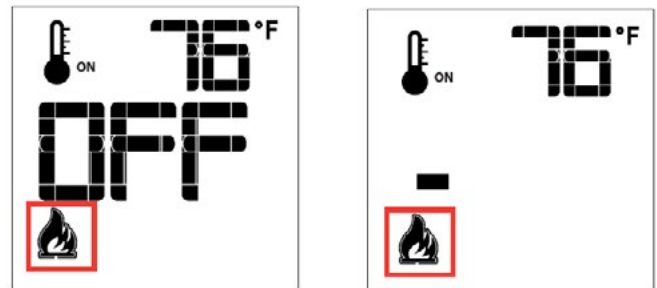

Figure 27.g Flame Off and Flame Level 1.

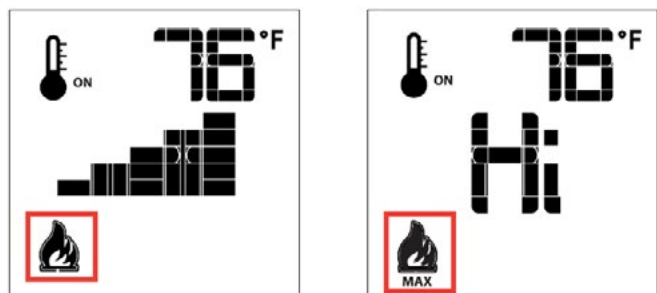

Figure 27.h Flame Level 5 and Flame Level Maximum

Room Thermostat (Remote Control Operation)

The Remote Control can operate as a room thermostat. The thermostat can be set to a desired temperature to control the comfort level in a room. To activate the function, press the Thermostat Key, see Figure 27i. The LCD display on the remote control will change to show that the room thermostat is "On" and the set temperature is now displayed. To adjust the set temperature press the Up or Down Arrow Keys until the desired set temperature is displayed on the LCD screen of the Transmitter.

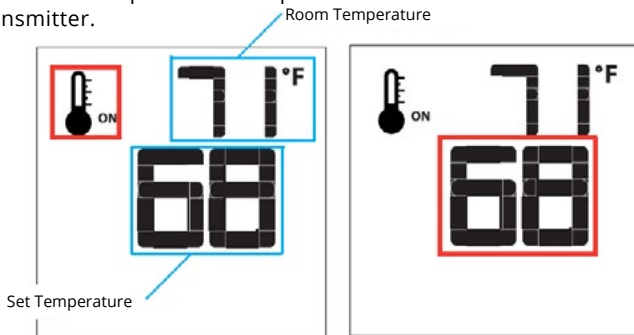

Figure 27.i Setting Room Thermostat

Smart Thermostat (Remote Control Operation)

The Smart Thermostat function adjusts the flame height in accordance to the difference between the set point temperature and the actual room temperatures. As the room temperature gets closer to the set point the Smart Function will modulate the flame down. To activate the function, press the Thermostat Key, see Figure 27.j, until the word "SMART" appears to the right of the temperature bulb graphic, see Figure 27j.

NOTE: When smart Thermostat is activated, manual flame height adjustment is disabled.

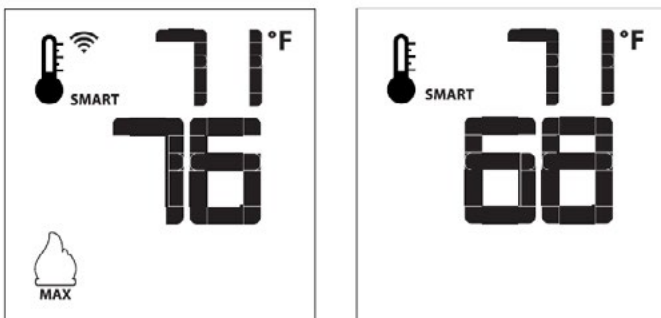

Figure 27.j Smart flame function

Disabling Thermostat

Some jurisdictions and bedroom installations require the thermostat to be disabled.

1. Partially take out one battery. Insert the battery while holding down the thermostat button. The remote screen will display 'Clr' while the button is held down.
2. To enable thermostat repeat steps 1-2. The remote screen will display 'set' while the thermostat button is held down.

Fan Speed Control

The fireplace is equipped with optional hot air circulating fans. The speed of the fans can be controlled by the Proflame system. The fan speed can be adjusted through six (6) speeds. To activate this function use the Mode Key, see Figure 27, to index to the fan control icon, see Figure 27m. Use the Up/Down Arrow Keys to turn on, off, or adjust the fan speed. A single "beep" will confirm reception of the command.

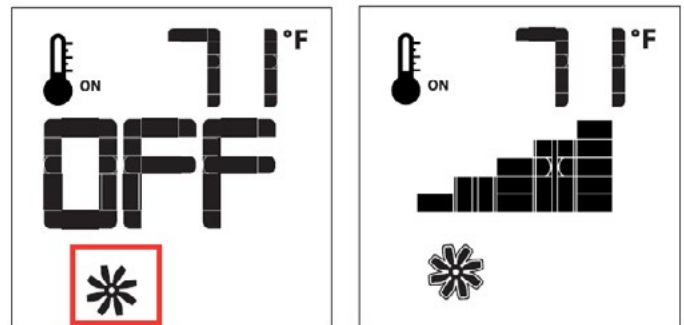

Figure 27.m Fan Speed Control

Accent Light Control

The function controls the power outlet by the dimmable light control. To activate this function use the Mode Key (fig. 29.n) to index to the LIGHT icon (fig. 29.n). The intensity of the output can be adjusted through six (6) levels. Use the Up/Down Arrow Keys (fig. 29.n) adjust the output level (fig. 29.n). A single "beep" will confirm reception of the command.

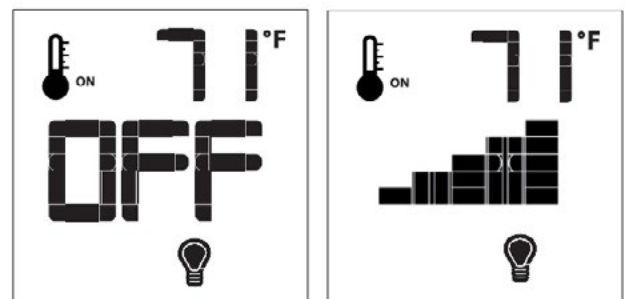

Figure 29.n Light Control

Pairing Issues

Some newer wi-fi capable transmitters PN# 0.584.080 (Montigo part RGC3105), and older IFC control board PN# 0.584.307 (Montigo part RGC3095) require that the wi-fi function in the transmitter be turned OFF before trying to pair or sync the components. First identify the supplied transmitter, the RGC3105 will have a wi-fi symbol on the battery cover sticker. The transmitter will not sync with the IFC control module RGC3095 which can be identified by the white stencil on top.

- Identify if the supplied transmitter, RGC3105 has a connection symbol on the battery cover sticker



- The above transmitter will not sync with the IFC control module RGC3095 which can be identified by the white stencil on top



Solution:

Disable the WiFi functionality by following these instructions

Disabling functions (Wi-Fi)

1. With batteries only partially inserted into the battery holder, keep pressed Power On/Off and O buttons.
2. Insert batteries keeping pressed the two buttons. The following screen is displayed. Each icon can be:

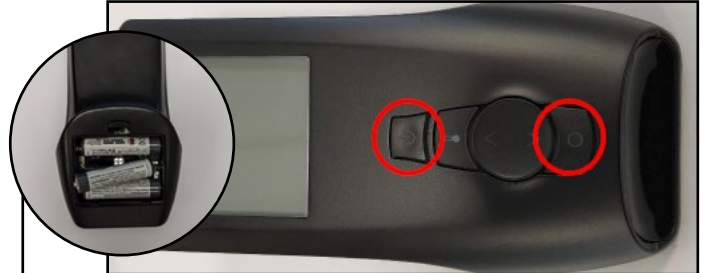

- Set the icon is set.
 - Clr: the icon is unset.
3. Keeping pressed the Power On/Off button, pressing the O button each icon can be selected



4. Keeping pressed the Power On/Off button and pressing the O button, navigate to the Transmission icon. This is in Clr state.



5. Keeping pressed the Power On/Off button, press the Up button to set the icon. And remove the symbol from the screen.

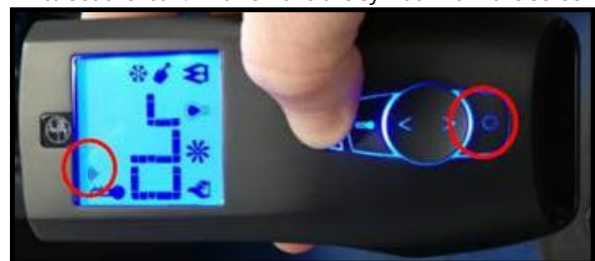

6. Release the Power On/Off button. The functionality is now enabled. The Tx Remote Command is now ready to be used.

Now the usual syncing steps outlined in the manual can be used by pressing the red SW1 button and the ON/OFF button on the transmitter. Note that the confirming 3 beeps should be heard when pressing the SW1 on the IFC board and the corresponding 3 beeps should be heard when pairing is successful.

FOR YOUR SAFETY - READ BEFORE LIGHTING:

DANGER



**HOT GLASS WILL CAUSE BURNS.
DO NOT TOUCH GLASS UNTIL COOLED.**

NEVER ALLOW CHILDREN TO TOUCH GLASS.

A barrier designed to reduce the risk of burns from the hot viewing glass is provided with this appliance and must be installed for the protection of children and other at-risk individuals.

WARNING: If the information in these instructions is not followed exactly, a fire or explosion may result causing property damage, personal injury or death.

WARNING/ CAUTION: Hot while in operation. Do not touch. Severe burns may result. Keep children, clothing, furniture, gasoline and other liquids having flammable vapours away.

See installation and operating instructions accompanying this appliance for more information.

A. This appliance is equipped with an ignition system that lights the pilot burner automatically. **Do not attempt to light the pilot by hand.**

B. **BEFORE LIGHTING** smell all around the appliance area for gas. Be sure to smell next to the floor because some gas is heavier than air and will settle on the floor.

What To Do If You Smell Gas:

- Do not try to light any appliance.
- Do not touch any electrical switch; do not use any phone in your building.

- Immediately call your gas supplier from a neighbour's phone. Follow the gas supplier's instructions.

- If you cannot reach your gas supplier, call the Fire Department.

C. Use only your hand to operate gas control. Never use tools. If the control does not function, don't try to repair it, call a qualified service technician. Force or attempt to repair may result in a fire or explosion.

D. Do not use this appliance if any part has been under water. Immediately call a qualified service technician to inspect the appliance and to replace any part of the control system, and any gas control which has been under water.

LIGHTING INSTRUCTIONS:

1. **STOP!** Read the safety information above on this label.
2. Turn "ON" manual "ON/OFF" switch. (If available)
3. Turn Incoming gas shut off valve to the "ON" position.
4. Wait 5 minutes to clear out any gas. If you smell gas, **STOP!** Follow "B" in the safety information above on this label. If you don't smell gas, go to the next step.
5. Turn fireplace "ON" using wall switch or remote control.
6. If the Fireplace does not light, the System will cycle through two trials, (one minute audible clicking, thirty seconds of silence, and then another one minute of audible clicking). If the system locks out due to inadequate gas flow, refer to "Troubleshooting" in instruction guide.
7. After completion of the information in the Troubleshooting section, Repeat step 5.
8. If the system will not function correctly, follow the instructions "To Turn Off Gas To Appliance" and call your service technician or gas supplier.

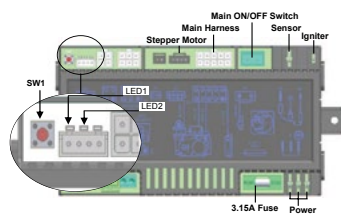

SW1 = Programming Button
 LED1 = Red Diagnostic Light
 LED2 = Amber Programming Remote Control Light
 Typical Control Module shown

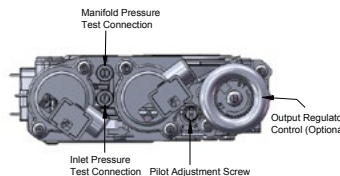

Gas Valve

TO TURN OFF GAS TO APPLIANCE:

1. Turn off fireplace using wall switch or remote control.
2. Turn the incoming gas shut off valve to "Off".

P/N LB1176-060614

Section 10: Cleaning and Maintenance

General

- Have the fireplace and installation inspected yearly. The inspection must include, but is not limited to, the following:
 - A visual check of the entire vent system and termination, where accessible.
 - An inspection of the explosion relief flappers and the door gaskets to ensure a proper seal.
 - An inspection of the burner, vent run, and primary air openings.
 - An inspection of the gas valve, gas components, and pilot flame. For your convenience a 1/8" manifold pressure tap is supplied on the gas valve for a test gauge connection.
 - Inspection of all optional equipment; fans, thermostats, remote control lights, etc.
- For Natural Gas this appliance requires a minimum inlet pressure of 5.5" W.C. and a manifold pressure of 3.5" W.C.
- For Propane Gas this appliance requires a minimum inlet pressure of 11" W.C. and a manifold pressure of 10" W.C.
- Always keep the fireplace area clear and free of combustibile materials, as well as gasoline and other flammable vapors and liquids.
- Do not use this appliance if any part has been under water. Immediately call a qualified service technician to inspect the appliance and to replace any part of the control system and any gas control which has been under water.
- Inspection of glass doors and screen for damage and proper installation.

Cleaning

When the fireplace is first activated, there may be some smoke and a visible film may be left on the glass. This is a normal condition, and is the result of burning of protective coatings on new metal.

- Glass must be cleaned periodically to remove any film (which is a normal by-product of combustion) which may be visible. Film can easily be removed by removing the door. Handle the door carefully, and clean it with non-abrasive, non-ammonia based glass cleaners. One of the most effective products is Kel-Kem.
- During the initial firing, Silicone seals will "off gas", leaving a visual deposit of a white substance on combustion chamber walls. This can easily be removed using normal household products.
- Use a vacuum cleaner or whisk broom to keep the control compartment, burner, and firebox free from dust and lint.

Pilot Burner Adjustment.

1. Locate Pilot Adjustment Screw. (See **figure 28**)
2. Adjust pilot screw to provide properly sized flame as shown.
3. After installing or servicing, leak test with a soap solution with main burner on. Coat pipe and tubing joints, gasket etc. with soap solution. Bubbles indicate leaks. Tighten any areas where the bubbles appear until the bubbling stops completely.

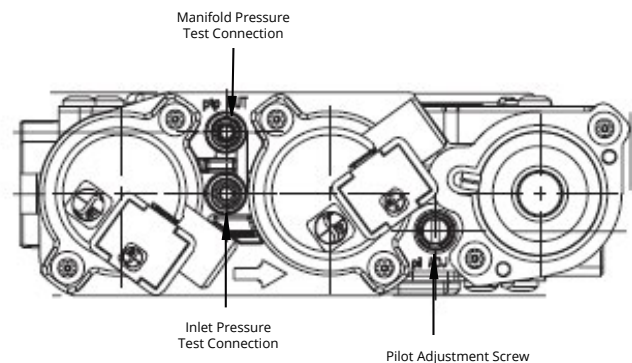

Figure 28. Pilot Adjustment on the SIT Proflame 2 gas valve.

NOTICE

Do not use ammonia or abrasive cleaners on the glass, they will permanently etch the surface. Use an approved gas fireplace cleaner such as Kel-Kem or White off.

Annual inspection list for determining safe operation of a direct vent gas fireplace

- 1) Inspect and operate the pressure relief mechanism to verify relief mechanisms are free from obstruction to operate.
- 2) Clean glass window with a suitable fireplace glass cleaner. Abrasive cleaners must not be used. Be careful not to scratch the glass when cleaning.
- 3) Inspect the operation of the flame safety system Pilot or Flame rectification device.
- 4) Inspect and ensure the lighting of the main burner occurs within 4 seconds of the main gas valve opening. Visual inspection should match that outlined in the appliance instruction manual. Inspect primary air openings for blockage.
- 5) Inspect condition of vent and vent terminal for sooting or obstruction and correct if present.
- 6) Vacuum and clean any debris in the firebox that is not supposed to be there.
- 7) Test and measure the flame failure response time of the flame safety system. It must de-energize the safety shutoff in no more than 30 seconds.
- 8) Check all accessible gas-carrying tubes, connections, pipes and other components for leaks.

POD - Pilot on Demand

What is POD mode?

This appliance is equipped with an "On Demand" intermittent pilot ignition system (IPI) which also includes a continuous pilot ignition (CPI) mode with an integrated seven day timer.

In IPI mode, the pilot will light before the main burner, when the appliance is turned on using a wall switch, remote or from a thermostat. Once the appliance is turned off, the main burner and pilot flame will shut down.

The continuous (CPI) mode exists to ease the startup phase in colder climates by keeping the firebox and venting warm when the main burner is not in use. The timer automatically switches off the pilot when the appliance has not been used for seven days.

When the CPI function is turned on, the pilot will remain on after the fireplace is turned off. A timer will then begin the countdown for approximately seven (7) days before shutting off the pilot if the appliance is not used. This countdown will reset anytime the burner is used.

If your appliance is equipped with a remote control device capable of selecting IPI / CPI modes, refer to remote operating instructions.

In order to start your pilot, turning the main burner on with the switch, remote or thermostat and then turning it off will reactivate the continuous pilot mode and reset the seven day timer.

A jumper is supplied with this unit that can be plugged into the wire harness connected to the controller. This jumper cable gives the Remote Control the ability to operate the POD / IPI switch and set the unit to operate in either condition. Please refer to jumper installation instructions for more information.

Remote Continuous Pilot (CPI) Selection

Requires installation of the CPI JUMPER

With the system in "off" position press the Mode Key, to index to the CPI mode icon, Pressing the Up Arrow Key will activate the Continuous Pilot Ignition mode (CPI). Pressing the Down Arrow Key will return to IPI. A single "beep" will confirm the reception of the command.

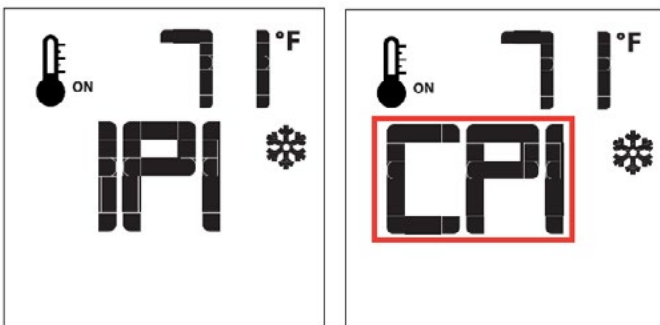

Installing the POD Jumper Cable

- 1). Access the control box.

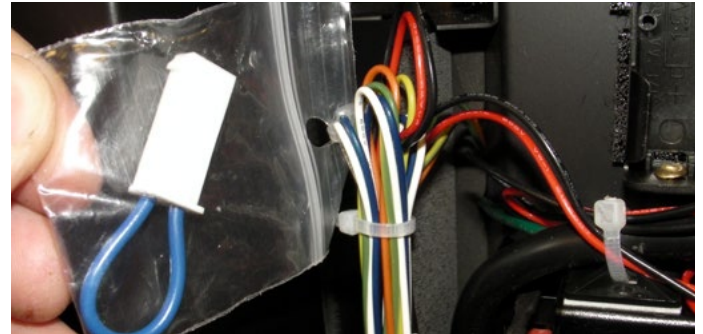

Figure 19.a Open the control box drawer

- 2). Remove the bag containing the Jumper Cable from the wire harness connected to the controller.

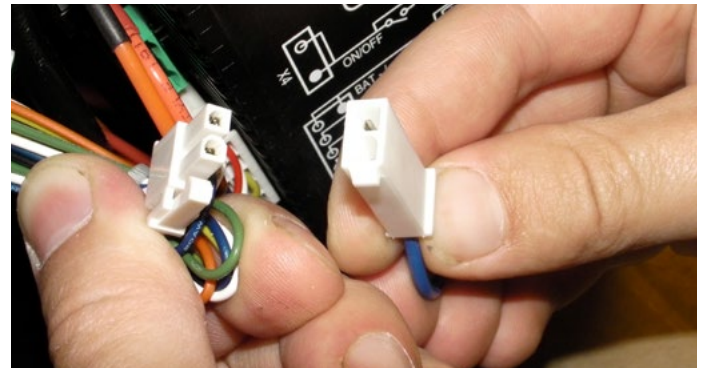

Figure 19.b Locate Jumper cable

- 3). Find the corresponding plug attached to the control wire harness and connect the CPI jumper.

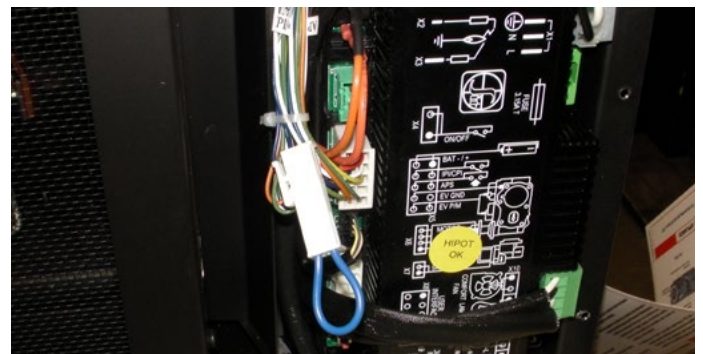

Figure 19.c Connect CPI

- 4). See operation section to turn remote into POD mode.

Troubleshooting

The following is a troubleshooting chart of possible problems:

PROBLEM	SOLUTION
Pilot Igniter won't spark	<ol style="list-style-type: none"> 1. Check the MAIN ON-OFF switch (typically located below the valve cover) and turn ON 2. Ensure main power is ON or new batteries are installed in the remote control and backup battery pack (if available). 3. Check the 3.15A fuse in the control box and replace if necessary
Pilot Igniter sparking, but Pilot burner will not light	<ol style="list-style-type: none"> 1. Verify the Inlet and Manifold Gas Pressure are within acceptable limits 2. Check all connections to gas valve 3. Check connection to stepper motor (if available)
Pilot lights , but Main burner will not Light	<ol style="list-style-type: none"> 1. Check and verify all wiring connections as per the wiring diagram. 2. Verify the inlet and Manifold Pressure are within acceptable limits
Pilot lights , but Main burner will not Light and igniter continues to spark	<ol style="list-style-type: none"> 1. Check the Pilot Flame Sensor Rod and clean with steel wool or similar. 2. Check the Pilot hood and clean with steel wool if dirty. 3. Adjust pilot flame using the pilot adjustment screw if the pilot flame is too long or too short (Flame should fully engulf the sensor rod and must be stable). 4. Check and make sure the ground wire from the pilot is connected to the fireplace body.

If your fireplace still does not operate correctly, consult your local Montigo dealer.

All service and repairs should be performed by a qualified Technician.

All spare parts, optional fans, and optional trim finishes are available from your local Montigo dealer.

Indoor fireplace in protected outdoor applications

This fireplace may be installed into outdoor locations provided they are suitably protected from direct water impingement. However, all installation clearances in the appliance manual must be observed. Framing, Clearances to Combustibles, Mantel Heights, Facing Requirements, Venting Installation, etc. Use supplied Safety Screen.

Dimension "A"	X .75	= min. overhang depth
The overhang must extend at least 75% of the roof line height (A) Height is measured from bottom of fireplace opening to the ceiling		

Example formula
Min. overhang = $A \times 0.75$
For example: if distance A is 84", the overhang must extend at least 63"

See through fireplace

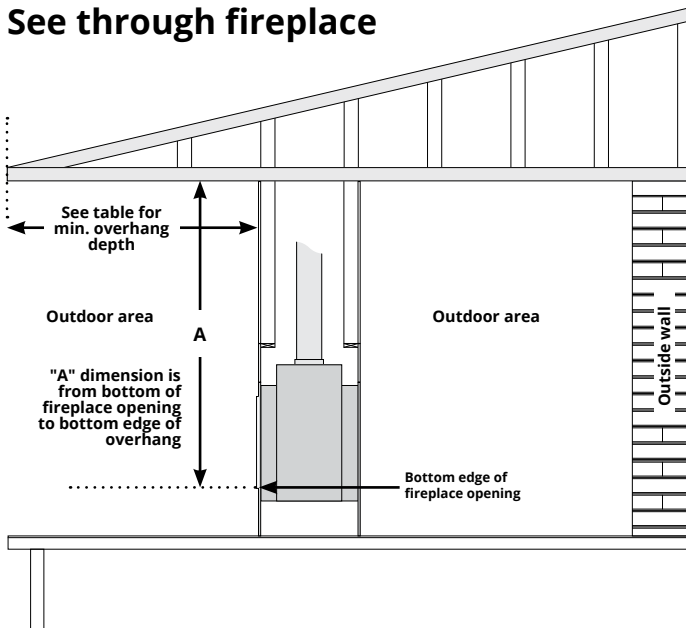

Single sided fireplace

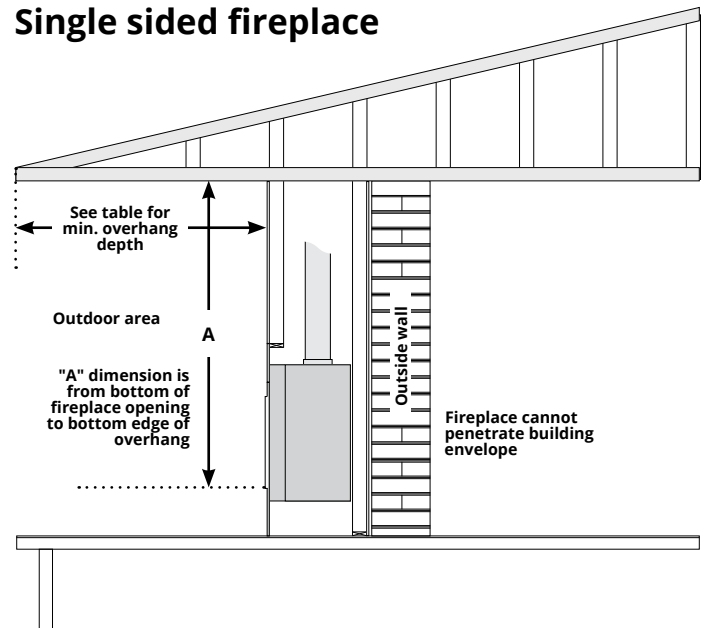

Notes

- Overhang requirements must be applied to both the front and sides of the fireplace
- Indoor see-through models cannot be installed as indoor/outdoor fireplaces, as air flows through both sides of the fireplace.
- If the fireplace will be in contact with salt water, then an outdoor fireplace is recommended
- Follow all building codes, including those addressing fireplace penetration of an exterior building envelope
- Follow all product installation instructions; including framing, clearances to combustibles, mantel heights, Facing Requirements, venting installation, etc. Use supplied safety screen.
- All wiring connections to line power shall be in accordance with outdoor requirements of; NECA NFPA 70 in the USA Canadian Electrical Code, CSA C22.1 for Canada.
- The Fireplace is not to be operated in temperatures below freezing (0°C | 32°F)

NOTICE

Units with tempered glass doors are vulnerable to rapid and/or extreme changes in temperature (thermal shock). Take care to prevent water from contacting the fireplace, especially if it is hot.

Appendix A: Venting Terminations

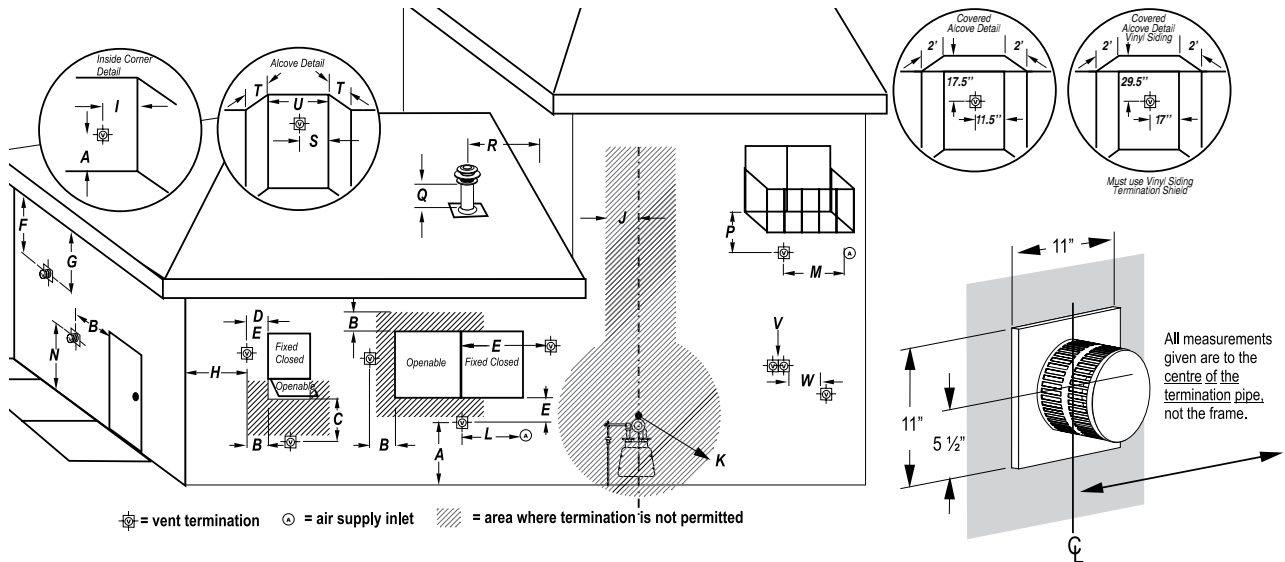

Location		Canada*	USA**
A	clearance to the termination frame above grade, veranda, porch, deck, or balcony	12 inches	12 inches
B	clearance to top of doors or operable windows	12 inches	12 inches
C	clearance to sides or bottom of door or operable windows	12 inches	9 inches
D	clearance to permanently closed window when installed with approved glass penetration termination	0	0
E	clearance to permanently closed window Recommended to prevent condensation	16 inches	16 inches
F	clearance to ventilated soffit located within a horizontal distance to 24 inches from centerline of termination	22 inches	22 inches
G	clearance to unventilated soffit	30 inches to combustibles 16 inches to non-combustibles	30 inches to combustibles 16 inches to non-combustibles
H	clearance to outside corner	9 inches	9 inches
I	clearance to inside corner	12 inches	12 inches
J	clearance to each side of the vertical centerline of a metre or regulatory assembly to a maximum vertical distance of 15ft	3 feet	3 feet
K	clearance to service regulator vent outlet	3 feet	3 feet
L	clearance to non mechanical air supply inlet to the building or combustion air inlet to other appliance for appliance <= 100,000 BTU/H (30 kW)	12 inches	12 inches
M	clearance to forced air supply inlet	6 feet	3 feet above air inlet
N	clearance above paved sidewalk or paved driveway located on public property	7 feet	7 feet
P	clearance under veranda, porch, deck, or balcony	22 inches to combustibles 16 inches to non-combustibles	22 inches to combustibles 16 inches to non-combustibles
Q	clearance above roof	2 feet	2 feet
R	clearance to adjacent walls and neighboring buildings	2 feet	18 inches
S	clearance from corner in recessed location	12 inches	12 inches
T	Maximum depth of recessed location	4 feet	4 feet
U	Maximum width for back wall of recessed location	2 feet	2 feet
V	Horizontal clearance between two terminations that are level	0	0
W	Horizontal clearance (centre to centre) between two terminations that are not level	18 inches	18 inches

Note 1: For N a vent shall not terminate directly above the sidewalk or paved driveway which is located between two single family dwellings and serve both dwelling.

Note 2: For P only permitted if veranda, porch, deck, or balcony is fully open on a minimum of two sides beneath the floor

Note 3: For J, K, and as specified in CGA B149 installation code. Local codes or regulations may vary.

* Based on CGA B149.1 Natural Gas and Propane installation code. Local codes may vary, please check with local regulatory agency.

** Based on ANSI Z223.1/NFPA 54 National Fuel Gas Code. Local codes may vary, please check with local regulatory agency.

Appendix B: Warranty

MONTIGO RESIDENTIAL WARRANTY PROGRAM

Empire Comfort Systems, Inc. and/or Empire Comfort Systems Canada, Inc. (collectively referred to herein as "The Companies"), warrants the Montigo gas appliance (referred to herein as 'the appliance') to be free from defects in materials and workmanship at the time of manufacture. The gas appliance and related components are further subject to the terms and conditions set forth below.

This warranty covers the following Montigo product series: **Distinction, Divine & Divine Outdoor (H-Series), Illume (FID Inserts), Phenom (L/P/PL-Series), Exemplar (R/RP-Series), Mahana and DelRay**

Component	Coverage Period	Labor Coverage
Firebox, heat exchanger	15 years	1 year
Main burner	15 years	1 year
Gas control valve and related control components (pilot assembly, spark electrode flame sensors, thermopile)	1 year	1 year
Electrical components (internal blowers, ignition control module, wiring, switches, remote control systems, blower control module, accent bulbs)	1 year	1 year
Firebox media (logset, glass beads, river rocks)	1 year	1 year
Glass (thermal breakage)	1 year	1 year
Plated, painted finishes (including interior reflective glass) *	1 year	1 year
Refractory lining	1 year	1 year
Mesh/Glass safety barriers	1 year	1 year
Power vent termination	1 year	1 year
Montigo terminations*	10 years	1 year
Montigo venting (excluding termination)	15 years	1 year

* Exterior painted surfaces exempt

QUALIFICATIONS TO THE WARRANTY

This Warranty only covers gas appliances installed in the United States or Canada.

To receive the benefits of this warranty, the appliance must be purchased, installed and serviced annually by a dealer authorized by The Companies for the warranty to be valid.

The gas appliance must be installed by a licensed professional in accordance with The Companies' installation instructions and local building codes. The warranty on the appliance covers only components manufactured by The Companies. The use of components manufactured or supplied by other manufacturers and used in conjunction with the appliance could create serious safety hazards, may result in the denial of certification by recognized national safety agencies and could violate local building codes. Such use may untimely void this warranty. This warranty does not cover any damages occurring from the use of any components not manufactured or supplied by The Companies.

The appliance must be subjected to normal use. The appliance is designed to burn natural gas (NG) or liquefied petroleum (LP) only. Burning conventional fireplace fuels such as wood, coal or

any other solid fuel will cause damage to the appliance, produce excessive temperatures will result in a fire hazard and void all warranties. This warranty is transferable. The appliance must remain in its original place of installation to be valid.

If the components of the appliance covered by this warranty are found to be defective within the time frame stated (see The Companies investigation of claims), The Companies will, at its option, replace or repair defective components of the appliance manufactured by The Companies at no charge and will also pay for labor costs (in accordance with schedule) incurred in replacing or repairing components. If repair or replacement is not commercially practical, The Companies will, at its sole discretion, fully discharge all obligations under the warranty by refunding the verified dealer purchase price of the appliance, excluding the cost of labor unless the labor is covered by the terms of the warranty.

This warranty covers only parts and labor as provided above. In no case shall the companies be responsible for materials, components or construction, which are not manufactured or supplied by The Companies, or for the labor necessary to install, repair or remove such materials, components or construction. All replacement or repair components will be shipped F.O.B. from the nearest Company factory.

LIMITATION ON LIABILITY

It is agreed and understood that The Companies sole obligation, and purchaser's exclusive remedy under this warranty, under any other warranty, expressed or implied, or in contract, tort or otherwise, shall be limited to repair, replacement or refund as specified above. The opinion of The Companies with respect to these matters shall be final.

In no event shall The Companies be responsible for any incidental or consequential damages caused by (but not limited to) improper installation, installation by an unqualified or unauthorized installer, accident, lack of regular maintenance, user error, abuse, misuse, Acts of God, power surges, floods, natural disasters, force majeure, defects in its appliance whether such damage occurs or is discovered before or after replacement or repair, and whether or not such damage is caused by The Companies negligence. Some jurisdictions do not allow the exclusion or limitation of incidental or consequential damages, so the above limitation or exclusion may not apply to you. The duration of any implied warranty with respect to the appliance is limited to the duration of the foregoing warranty. Some jurisdictions do not allow limitations on how long an implied warranty lasts, so the above limitation or exclusion may not apply to you.

Appendix B: Warranty Continued

EXCLUSIONS TO WARRANTY

Corrosion or rust of any kind due to a lack of maintenance, inadequate combustion air or improper venting and corrosive chemicals/environments, expansion and contraction of metals or minor movements of components causing noise are not covered by this warranty.

Willful misconduct (i.e. use of the appliance with problems known to the purchaser and causing further damages), including unauthorized or self-performed 'fixing' or exploration of the appliance's internal workings will void the warranty.

Appliances on which the serial number has been altered, defaced, removed or made illegible will void the warranty.

Costs incurred for diagnosis, service work, shipping and handling of defective or replacement parts are not covered under this warranty.

The published warranties are not applicable for any equipment manufactured by The Companies that has been sold direct to the consumer via internet or auction websites. The Companies do not endorse, approve or certify any online sale of its products through auction websites, online retailers or any other method of online sales direct to consumers.

INVESTIGATION OF CLAIMS AGAINST WARRANTY

The Companies reserve the right to investigate any and all claims against this warranty and decide upon method of settlement.

The Companies are not responsible for work done without written consent of The Companies.

The Companies shall in no event be responsible for any warranty work done without first obtaining the Companies written consent.

The Companies employees and dealers have no authority to make any warranties to neither alter this warranty nor authorize any remedies in addition to or inconsistent with those stated within this warranty.

IF WARRANTY SERVICE IS NEEDED

To make a claim under this warranty, contact your installing dealer or contractor. The installing dealer is responsible for providing service and will contact the companies to initiate warranted parts replacements. In the event the installing dealer is unavailable, contact your nearest authorized Montigo dealer (www.Montigo.com) or contact Montigo direct at techsupport@montigo.com. Ensure you have your sales receipt and the model and serial number of your appliance.

DO NOT ATTEMPT TO DO ANY SERVICE WORK YOURSELF

If you cannot locate the installing dealer, or nearest dealer/distributor, you must notify The Companies in writing.

USA Offices

6955 Salashan Parkway
Ferndale WA, 98248
techsupport@montigo.com

Canadian Offices

27342 Gloucester Way
Langley, BC V4W 4A1
techsupport@montigo.com

The terms and conditions of this warranty may be altered or amended from time to time without prior notice.

WARRANTY PERIOD: Warranty coverage begins on the date of original purchase. In the case of new construction, warranty coverage begins on the date of first occupancy of the dwelling or six months after the sale of the product by an independent, authorized Company dealer/ distributor, whichever occurs earlier.

Appendix C: Amendment

(Gas Fireplace / Equipment sold in the State of Massachusetts)
5.08: Modifications to NFPA-54, Chapter 10

- (1) Revise NFPA-54 section 10.5.4.2 by adding a second exception as follows:

Existing chimneys shall be permitted to have their use continued when a gas conversion burner is installed, and shall be equipped with a manually reset device that will automatically shut off the gas to the burner in the event of a sustained back-draft.

- (2) Revise 10.8.3 by adding the following additional requirements:

- (a) For all side wall horizontally vented gas fueled equipment installed in every dwelling, building or structure used in whole or in part for residential purposes, including those owned or operated by the Commonwealth and where the side wall exhaust vent termination is less than seven (7) feet above finished grade in the area of the venting, including but not limited to decks and porches, the following requirements shall be satisfied:

1. **INSTALLATION OF CARBON MONOXIDE DETECTORS.** At the time of installation of the side wall horizontal vented gas fueled equipment, the installing plumber or gas fitter shall observe that a hard wired carbon monoxide detector with an alarm and battery back-up is installed on the floor level where the gas equipment is to be installed. In addition, the installing plumber or gas fitter shall observe that a battery operated or hard wired carbon monoxide detector with an alarm is installed on each additional level of the dwelling, building or structure served by the side wall horizontal vented gas fueled equipment. It shall be the responsibility of the property owner to secure the services of qualified licensed professionals for the installation of hard wired carbon monoxide detectors
 - a. In the event that the side wall horizontally vented gas fueled equipment is installed in a crawl space or an attic, the hard wired carbon monoxide detector with alarm and battery back-up may be installed on the next adjacent floor level.
 - b. In the event that the requirements of this subdivision can not be met at the time of completion of installation, the owner shall have a period of thirty (30) days to comply with the above requirements; provided, however, that during said thirty (30) day period, a battery operated carbon monoxide detector with an alarm shall be installed.
2. **APPROVED CARBON MONOXIDE DETECTORS.** Each carbon monoxide detector as required in accordance with the above provisions shall comply with NFPA 720 and be ANSI/UL 2042 listed and IAS certified.
3. **SIGNAGE.** A metal or plastic identification plate shall be permanently mounted to the exterior of the building at a minimum height of eight (8) feet above grade directly in line with the exhaust vent terminal for the horizontally vented gas fueled heating appliance or equipment. The sign shall read, in print size no less than one-half (1/2) inch in size, "GAS VENT DIRECTLY BELOW. KEEP CLEAR OF ALL OBSTRUCTIONS".

4. **INSPECTION.** The state or local gas inspector of the side wall horizontally vented gas fueled equipment shall not approve the installation unless, upon inspection, the inspector observes carbon monoxide detectors and signage installed in accordance with the provisions of 248 CMR 5.08(2)(a)1 through 4.

- (b) **EXEMPTIONS:** The following equipment is exempt from 248 CMR 5.08(2)(a)1 through 4:

1. The equipment listed in Chapter 10 entitled "Equipment Not Required To Be Vented" in the most current edition of NFPA 54 as adopted by the Board; and
 2. Product Approved side wall horizontally vented gas fueled equipment installed in a room or structure separate from the dwelling, building or structure used in whole or in part for residential purposes.
- (c) **MANUFACTURER REQUIREMENTS - GAS EQUIPMENT VENTING SYSTEM PROVIDED.** When the manufacturer of Product Approved side wall horizontally vented gas equipment provides a venting system design or venting system components with the equipment, the instructions provided by the manufacturer for installation of the equipment and the venting system shall include:
1. Detailed instructions for the installation of the venting system design or the venting system components; and
 2. A complete parts list for the venting system design or venting system.
- (d) **MANUFACTURER REQUIREMENTS - GAS EQUIPMENT VENTING SYSTEM NOT PROVIDED.** When the manufacturer of a Product Approved side wall horizontally vented gas fueled equipment does not provide the parts for venting the flue gases, but identifies "special venting systems", the following requirements shall be satisfied by the manufacturer:
1. The referenced "special venting system" instructions shall be included with the appliance or equipment installation instructions; and
 2. The "special venting systems" shall be Product Approved by the Board, and the instructions for that system shall include a parts list and detailed installation instructions.
- (e) A copy of all installation instructions for all Product Approved side wall horizontally vented gas fueled equipment, all venting instructions, all parts lists for venting instructions, and/or all venting design instructions shall remain with the appliance or equipment at the completion of the installation.
- (3) After NFPA-54 section 10.10.4.2 add a new section 10.10.4.3 as follows:
- When more than four gas appliances are to be vented through a common gas vent or common horizontal vent manifold, a plan of the proposed vent installation shall be submitted to the Inspector and the serving gas supplier for review and approval.

Extraction from: Massachusetts Rules and Regulations

5.00: Amendments To 2002 Edition Of ANSI Z223.1-NFPA-54

DRL3613*I BASIC Exploded Parts

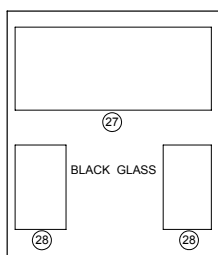
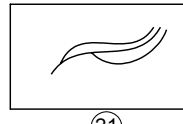
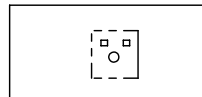
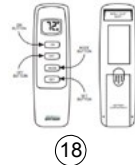
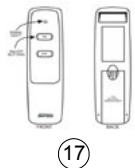
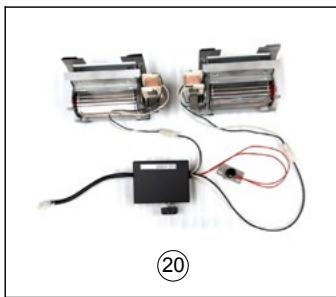
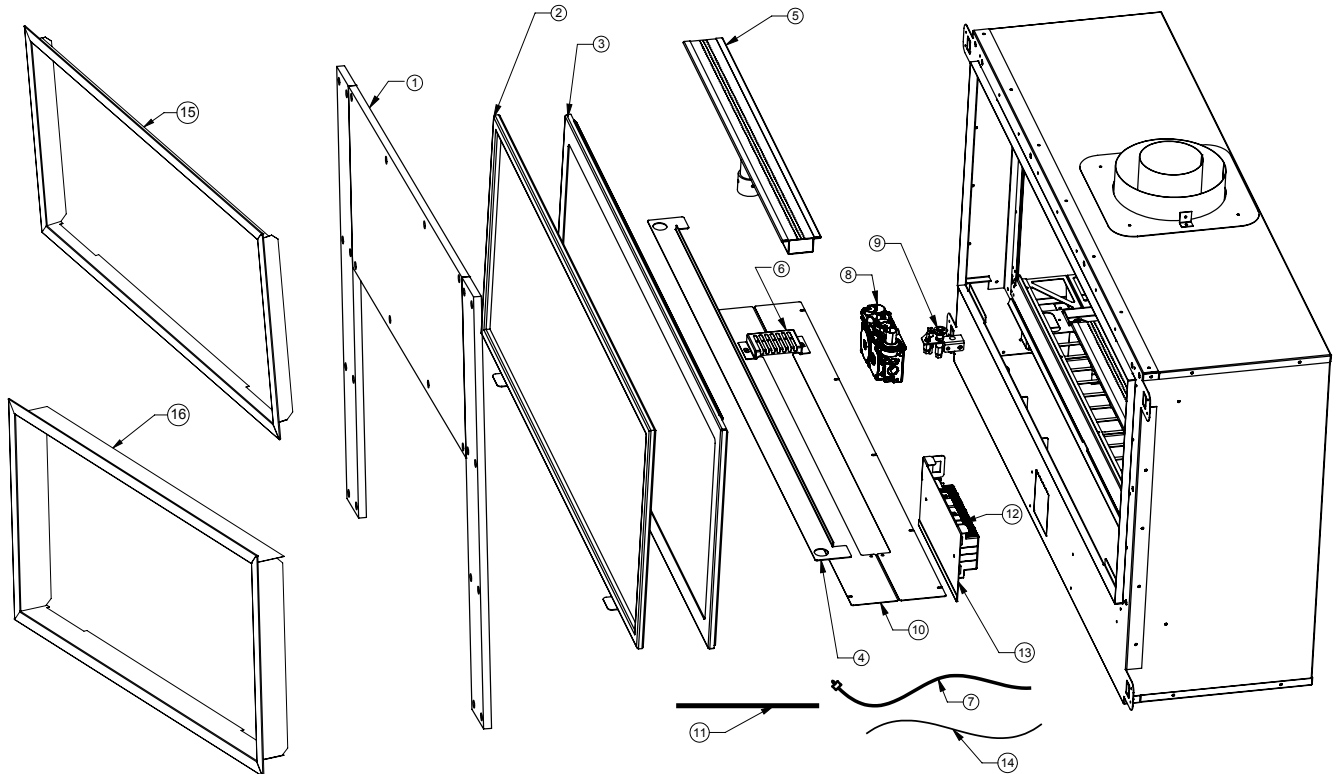

	Name	Code
Standard Parts		
1	CEMENT BOARD	CBSDRL36
2	SCREEN	RSCDRL3613
3	DOOR	RDTDRL3613
4	VALVE COVER	RVBDRL3613
5a	BURNER ASSEMBLY Ribbon	RBDRDL3613
5b	BURNER ASSEMBLY High-Low	RBHL3613
6	PILOT COVER	RPCDRL
7	REPLACEMENT POWER HARNESS	RECA131
8	VALVE	RGC3089
9	PILOT	RPA035
10	PERFORATED ROCK TRAY	RRTDRL36
11	PILOT TUBING 24"	RPTA03
12	FUSE 3.5A	REC1386
13	PROFLAME 2 BASIC CONTROL BOARD	RGC3094
14	PROFLAME 2 BOARD HARNESS	REC3062

	Name	Code
Optional Parts		
15	ADJUSTABLE TRIM KIT 0-11/16"	DRLT36
16	ADJUSTABLE TRIM KIT 1 1/2" - 2"	DRLT36-2
17	DELRAY ON/OFF REMOTE	RX40
18	DELRAY THERMOSTATIC REMOTE	RX60
19	LP CONVERSION KIT	GCA010
20	BASIC FAN KIT	DRFK1
21	DELRAY PV WIRE HARNESS	ECA136PV
22	FASTENER REPAIR KIT	RKIT01
26	BLACK GLASS KIT	RBGDRL36
27	REAR BLACK GLASS	RGL5115
28	SIDE BLACK GLASS	RGL5116

DRL3613*I-2 FULL LOAD Exploded Parts

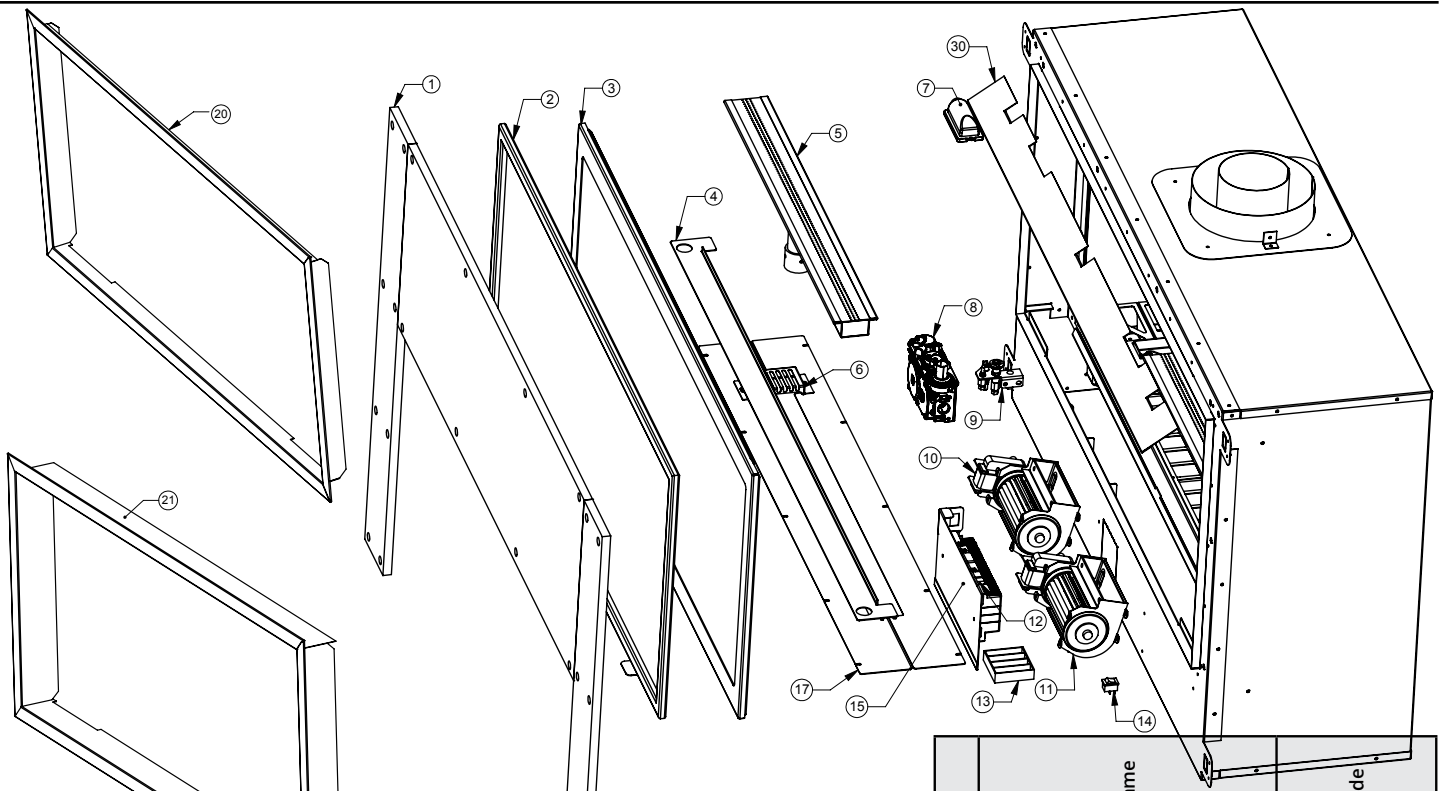

Name	Code
Standard Parts	
1 CEMENT BOARD	CBSDRL36
2 SCREEN	SCRIDRL36
3 DOOR	RDTDRL3613
4 VALVE COVER	RVBDRL3613
5a BURNER ASSEMBLY Ribbon	RBDRL3613
5b BURNER ASSEMBLY High-Low	RBHL3613
6 PILOT COVER	RPCDRL
7 REPLACEMENT BULB	REC1546
8 VALVE	RGC3089
9 PILOT	RPA035
10 LEFT FAN	REC1377DRL
11 RIGHT FAN	REC1378DRL
12 FUSE 3.5A	REC1386
13 BATTERY HOLDER (4)	AF40BP
14 ON OFF SWITCH	RECA015
15 PROFLAME2 FULL CONTROL BOARD	RGC3104
16 PILOT TUBING 24"	RPTA03
17 PERFORATED ROCK TRAY	RRTDRL36
18 POWER HARNESS	RECA131
19 PROFLAME2 BOARD HARNESS	REC3062
26 BLACK GLASS KIT	RBGDRL36
27 REAR BLACK GLASS	RGL5115
28 SIDE BLACK GLASS	RGL5116
29 REMOTE	RGC3063
30 AIR FLOW BRACKET	RAFBDRL3613

Name	Code
Optional Parts	
20 ADJUSTABLE TRIM KIT 0-11/16"	DRLT36
21 ADJUSTABLE TRIM KIT 1 1/2" - 2"	DRLT36-2
22 WALL MOUNT PROFLAME2 REMOTE	REC1493
23 LP CONVERSION KIT	GCA010
24 DELRAY PV WIRE HARNESS	ECA136PV
25 FASTENER REPAIR KIT	RKIT01

DRL4813*I BASIC Exploded Parts

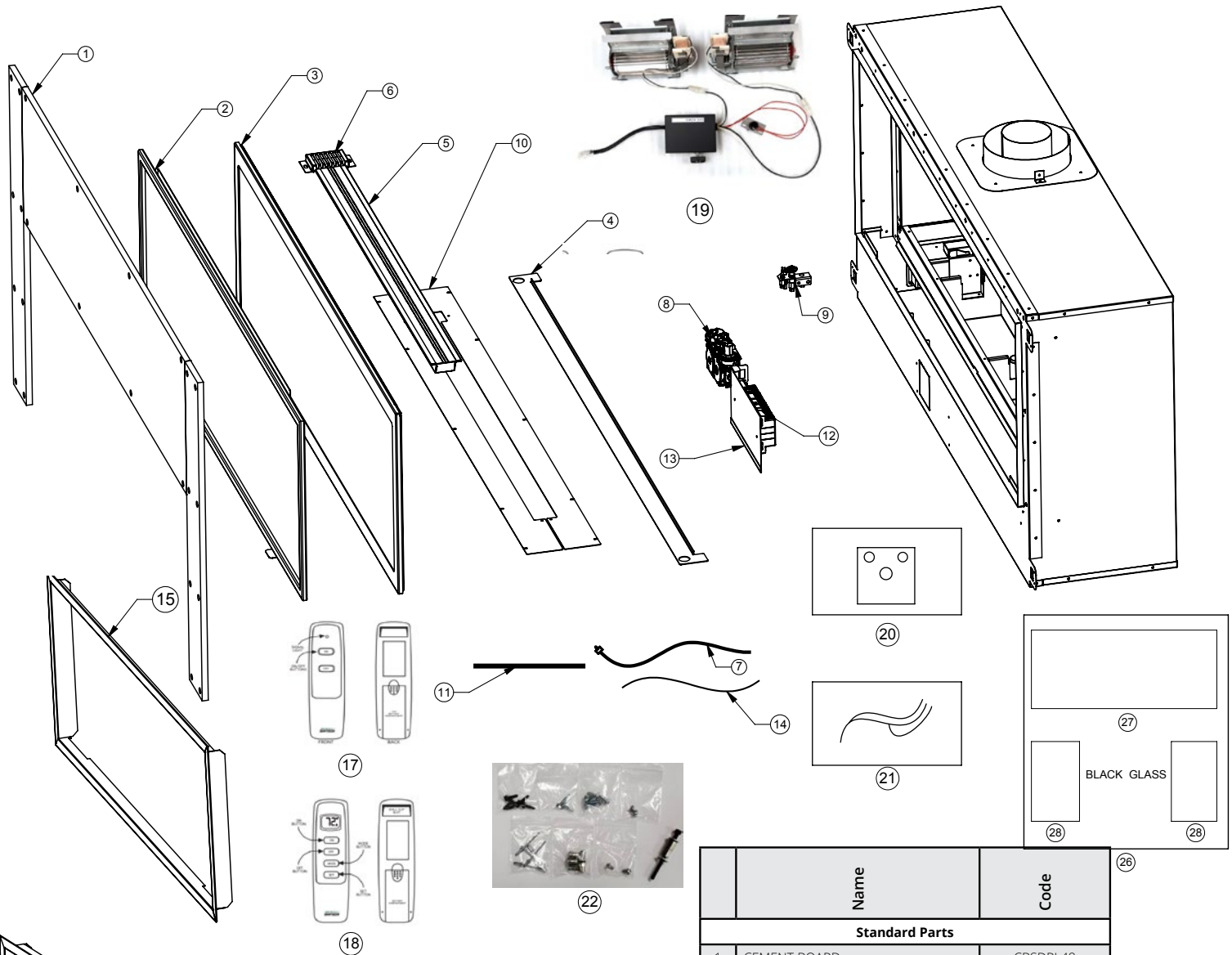

Name	Code
Optional Parts	
15 ADJUSTABLE TRIM KIT 0-11/16"	DRLT48
16 ADJUSTABLE TRIM KIT 1 1/2" - 2"	DRLT48-2
17 DELRAY ON/OFF REMOTE	RX40
18 DELRAY THERMOSTATIC REMOTE	RX60
19 BASIC FAN KIT	DRFK1
20 LP CONVERSION KIT	GCA019
21 DELRAY PV WIRE HARNESS	ECA136PV
22 FASTENER REPAIR KIT	RKIT01
26 BLACK GLASS KIT	RBGDRL48
27 REAR BLACK GLASS	RGL5117
28 SIDE BLACK GLASS	RGL5116

Name	Code
Standard Parts	
1 CEMENT BOARD	CBSDRL48
2 SCREEN	RSCDRL4813
3 DOOR	RDTDRL4813
4 VALVE COVER	RVBDRL4813
5a BURNER ASSEMBLY Ribbon	RBDR4813
5b BURNER ASSEMBLY High-Low	RBHL4813
6 PILOT COVER	RPCDRL
7 REPLACEMENT POWER HARNESS	RECA131
8 VALVE	RGC3089
9 PILOT	RPA035
10 PERFORATED ROCK TRAY	RRTDRL48
11 PILOT TUBING 24"	RPTA03
12 FUSE 3.5A	REC1386
13 PROFLAME 2 BASIC CONTROL BOARD	RGC3094
14 PROFLAME 2 BOARD HARNESS	REC3062

DRL4813*I-2 FULL LOAD Exploded Parts

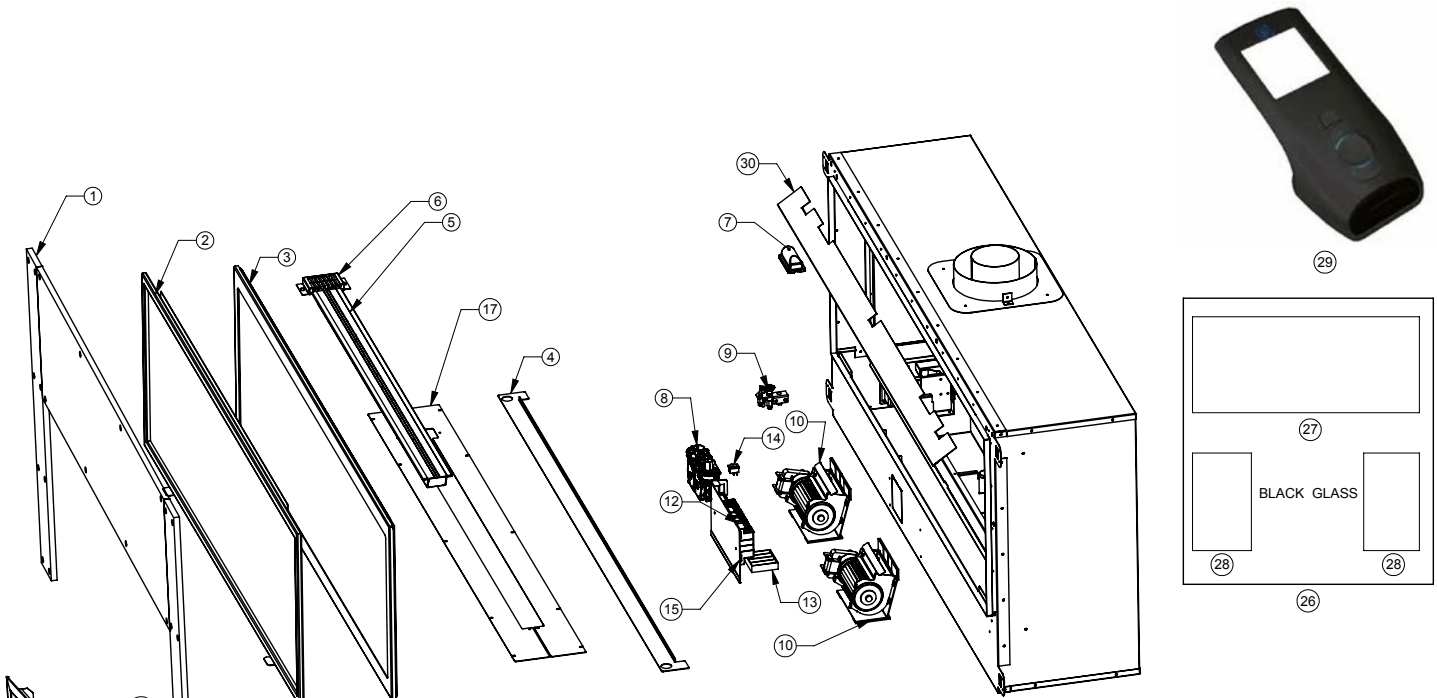

	Name	Code
Optional Parts		
20	ADJUSTABLE TRIM KIT 0-11/16"	DRLT48
21	ADJUSTABLE TRIM KIT 1 1/2" - 2"	DRLT48-2
22	WALL MOUNT PROFLAME2 REMOTE	REC1550
23	LP CONVERSION KIT	GCA019
24	DELRAY PV WIRE HARNESS	ECA136PV
25	FASTENER REPAIR KIT	RKIT01



22

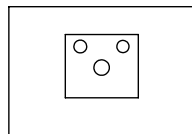

23

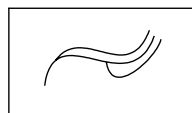

24



25

	Name	Code
Standard Parts		
1	CEMENT BOARD	CBSDRL48
2	SCREEN	SCRIDRL48
3	DOOR	RDTDRL4813
4	VALVE COVER	RVBDRL4813
5a	BURNER ASSEMBLY Ribbon	RBDRL4813
5b	BURNER ASSEMBLY High-Low	RBHL4813
6	PILOT COVER	RPCDRL
7	REPLACEMENT BULB	REC1546
8	VALVE	RGC3089
9	PILOT	RPA035
10	LEFT FAN	REC1377DRL
11	RIGHT FAN	REC1378DRL
12	FUSE 3.5A	REC1386
13	BATTERY HOLDER (4)	AF40BP
14	ON OFF SWITCH	RECA015
15	PROFLAME2 FULL CONTROL BOARD	RGC3104
16	PILOT TUBING 24"	RPTA03
17	PERFORATED ROCK TRAY	RRTDRL48
18	POWER HARNESS	RECA131
19	PROFLAME2 BOARD HARNESS	REC3062
26	BLACK GLASS KIT	RBGDRL48
27	REAR BLACK GLASS	RGL5117
28	SIDE BLACK GLASS	RGL5116
29	REMOTE	RGC3105
30	AIR FLOW BRACKET	RAFBDR4813

DRL6013*I BASIC Exploded Parts

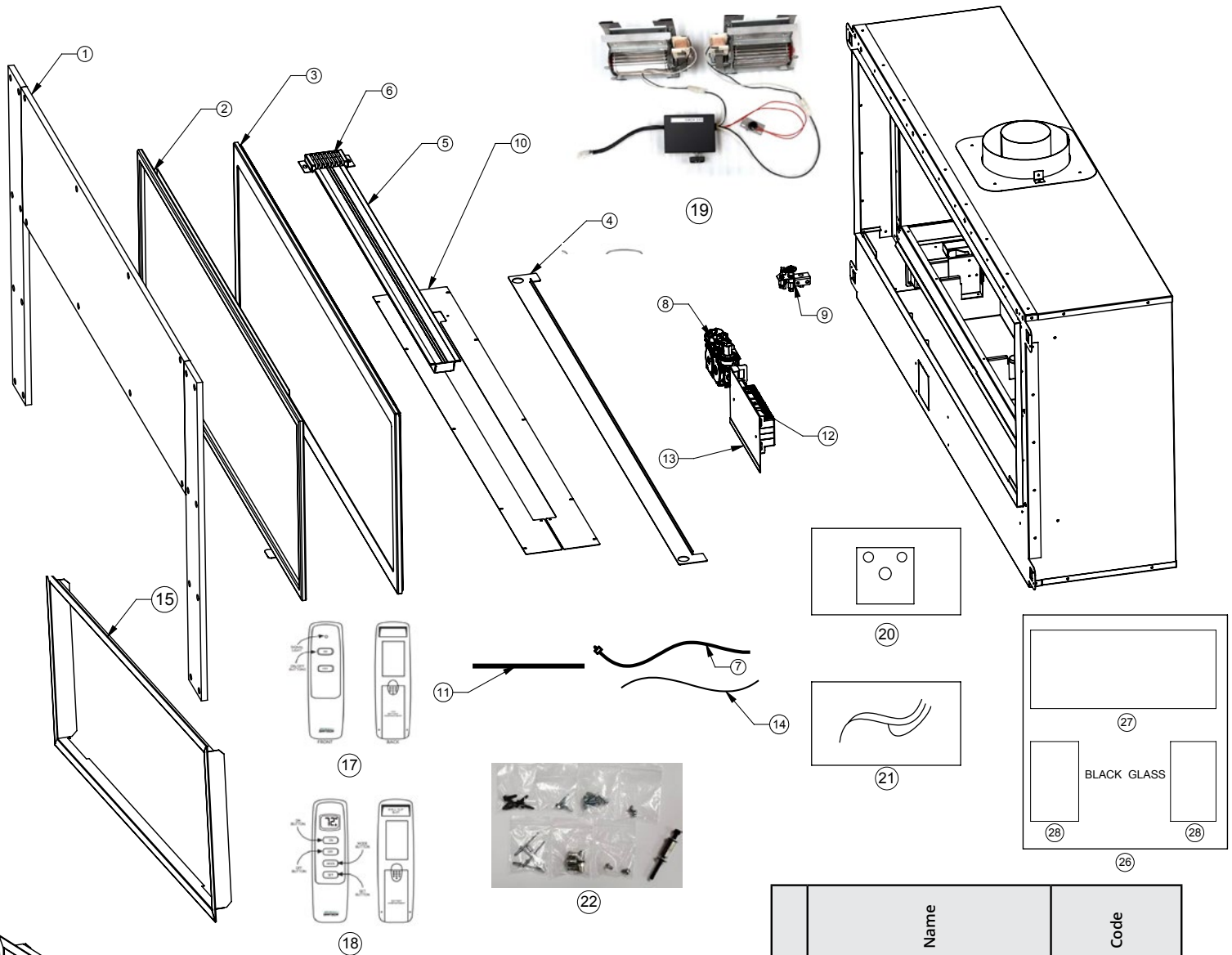

	Name	Code
Optional Parts		
15	ADJUSTABLE TRIM KIT 0-11/16"	DRLT60
16	ADJUSTABLE TRIM KIT 1 1/2" - 2"	DRLT60-2
17	DELRAY ON/OFF REMOTE	RX40
18	DELRAY THERMOSTATIC REMOTE	RX60
19	BASIC FAN KIT	DRFK1
20	LP CONVERSION KIT	GCA038
21	DELRAY PV WIRE HARNESS	ECA136PV
22	FASTENER REPAIR KIT	RKIT01
26	BLACK GLASS KIT	RBGDRL60
27	REAR BLACK GLASS	RGL5126
28	SIDE BLACK GLASS	RGL5116

	Name	Code
Standard Parts		
1	CEMENT BOARD	CBSDRL60
2	SCREEN	RSCDRL6013
3	DOOR	RDTDRL6013
4	VALVE COVER	RVBDRL6013
5	BURNER ASSEMBLY	RBDR6013
6	PILOT COVER	RPCDRL
7	REPLACEMENT POWER HARNESS	RECA131
8	VALVE	RGC3089
9	PILOT	RPA035
10	PERFORATED ROCK TRAY	RRTDRL60
11	PILOT TUBING 24"	RPTA03
12	FUSE 3.5A	REC1386
13	PROFLAME 2 BASIC CONTROL BOARD	RGC3094
14	PROFLAME 2 BOARD HARNESS	REC3062

DRL6013*I-2 FULL LOAD Exploded Parts

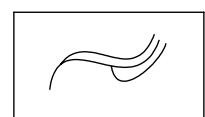
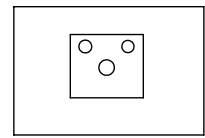
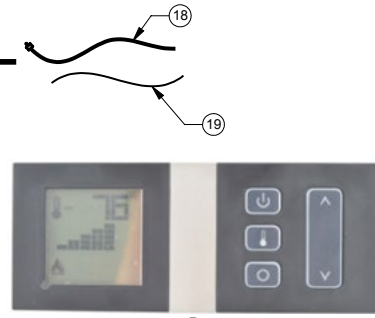
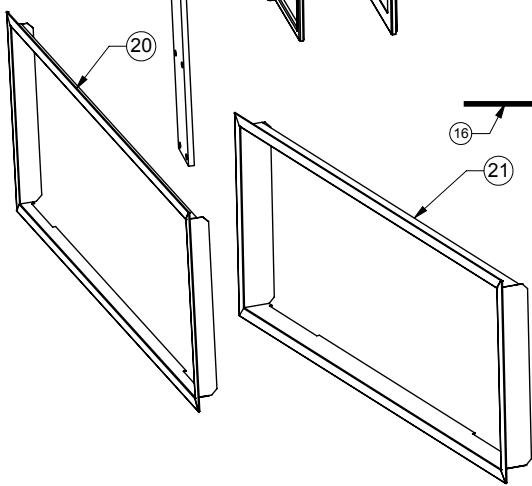
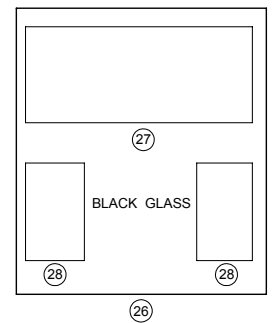
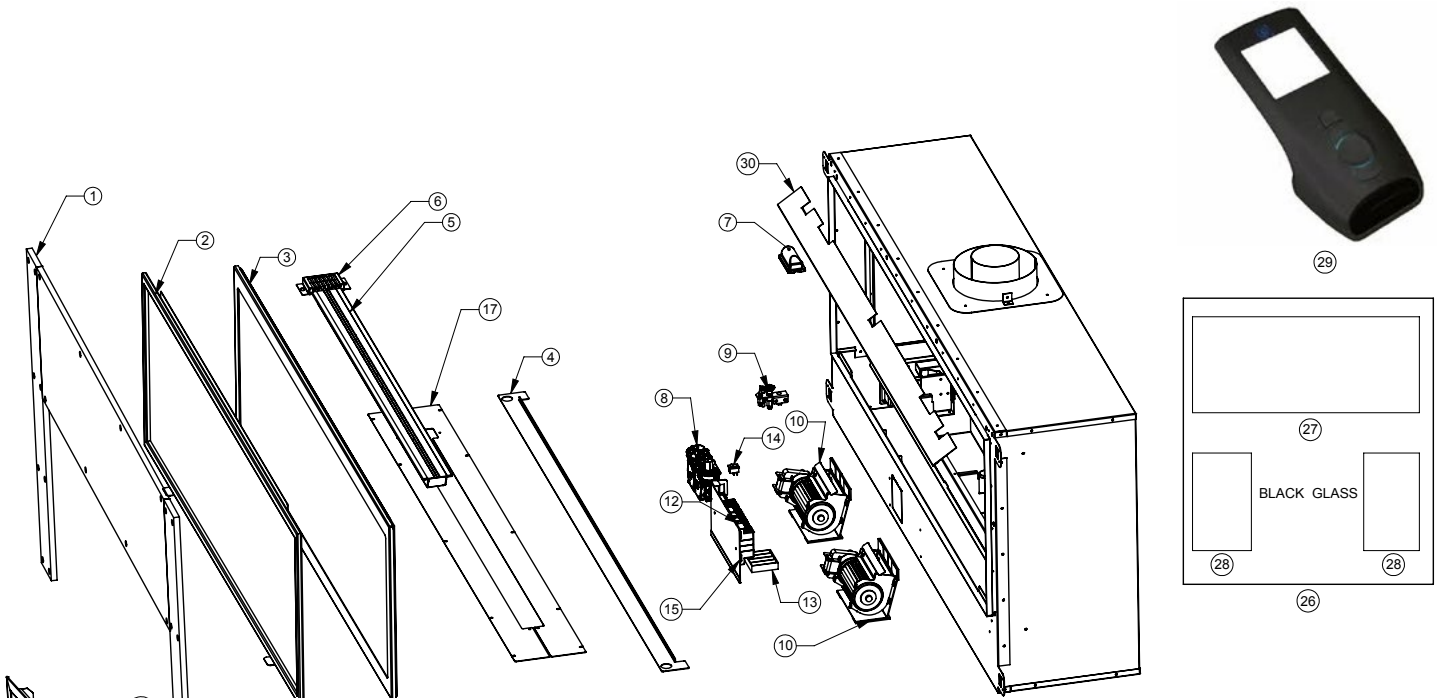

	Name	Code
Optional Parts		
20	ADJUSTABLE TRIM KIT 0-11/16"	DRLT60
21	ADJUSTABLE TRIM KIT 1 1/2" - 2"	DRLT60-2
22	WALL MOUNT PROFLAME2 REMOTE	REC1550
23	LP CONVERSION KIT	GCA019
24	DELRAY PV WIRE HARNESS	ECA136PV
25	FASTENER REPAIR KIT	RKIT01

	Name	Code
Standard Parts		
1	CEMENT BOARD	CBSDRL60
2	SCREEN	SCRIDRL60
3	DOOR	RDTDRL6013
4	VALVE COVER	RVBDRL6013
5	BURNER	RBDRDL6013
6	PILOT COVER	RPCDRL
7	REPLACEMENT BULB	REC1546
8	VALVE	RGC3089
9	PILOT	RPA035
10	LEFT FAN	REC1377DRL
11	RIGHT FAN	REC1378DRL
12	FUSE 3.5A	REC1386
13	BATTERY HOLDER (4)	AF40BP
14	ON OFF SWITCH	RECA015
15	PROFLAME2 FULL CONTROL BOARD	RGC3104
16	PILOT TUBING 24"	RPTA03
17	PERFORATED ROCK TRAY	RRTDRL60
18	POWER HARNESS	RECA131
19	PROFLAME2 BOARD HARNESS	REC3062
26	BLACK GLASS KIT	RBGDRL60
27	REAR BLACK GLASS	RGL5126
28	SIDE BLACK GLASS	RGL5116
29	REMOTE	RGC3105
30	AIR FLOW BRACKET	RAFBDRDL6013

DRL7213*I BASIC Exploded Parts

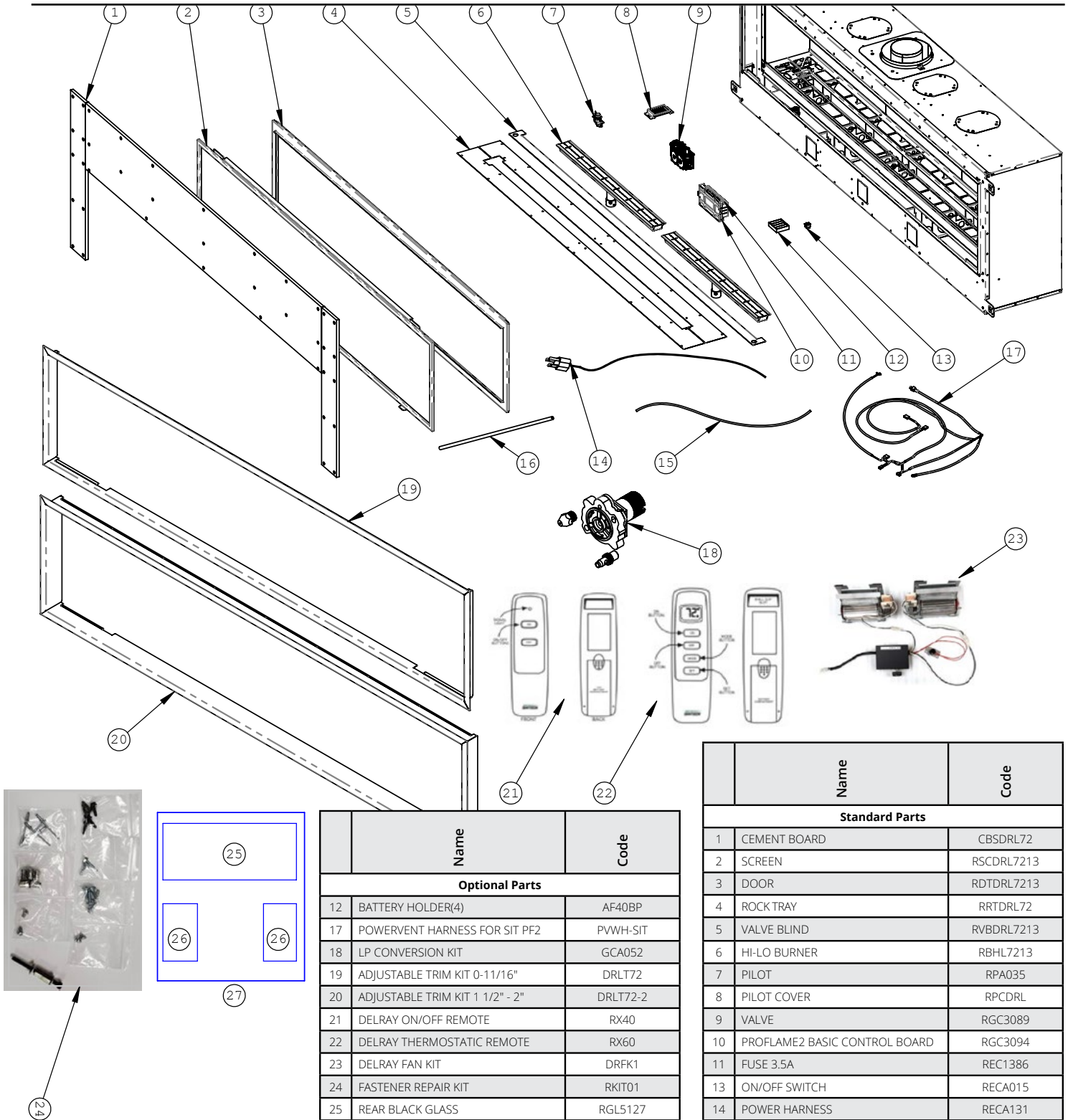

	Name	Code
Optional Parts		
12	BATTERY HOLDER(4)	AF40BP
17	POWERVENT HARNESS FOR SIT PF2	PVWH-SIT
18	LP CONVERSION KIT	GCA052
19	ADJUSTABLE TRIM KIT 0-11/16"	DRLT72
20	ADJUSTABLE TRIM KIT 1 1/2" - 2"	DRLT72-2
21	DELRAY ON/OFF REMOTE	RX40
22	DELRAY THERMOSTATIC REMOTE	RX60
23	DELRAY FAN KIT	DRFK1
24	FASTENER REPAIR KIT	RKIT01
25	REAR BLACK GLASS	RGL5127
26	SIDE BLACK GLASS	RGL5128
27	BLACK GLASS KIT DRL72	RGBDRL72

	Name	Code
Standard Parts		
1	CEMENT BOARD	CBSDRL72
2	SCREEN	RSCDRL7213
3	DOOR	RDTDRL7213
4	ROCK TRAY	RRTDRL72
5	VALVE BLIND	RVBDRL7213
6	HI-LO BURNER	RBHL7213
7	PILOT	RPA035
8	PILOT COVER	RPCDRL
9	VALVE	RGC3089
10	PROFLAME2 BASIC CONTROL BOARD	RGC3094
11	FUSE 3.5A	REC1386
13	ON/OFF SWITCH	RECA015
14	POWER HARNESS	RECA131
15	PROFLAME2 BOARD HARNESS	REC3062
16	PILOT TUBING 24"	RPTA03

DRL7213*I-2 FULL LOAD Exploded Parts

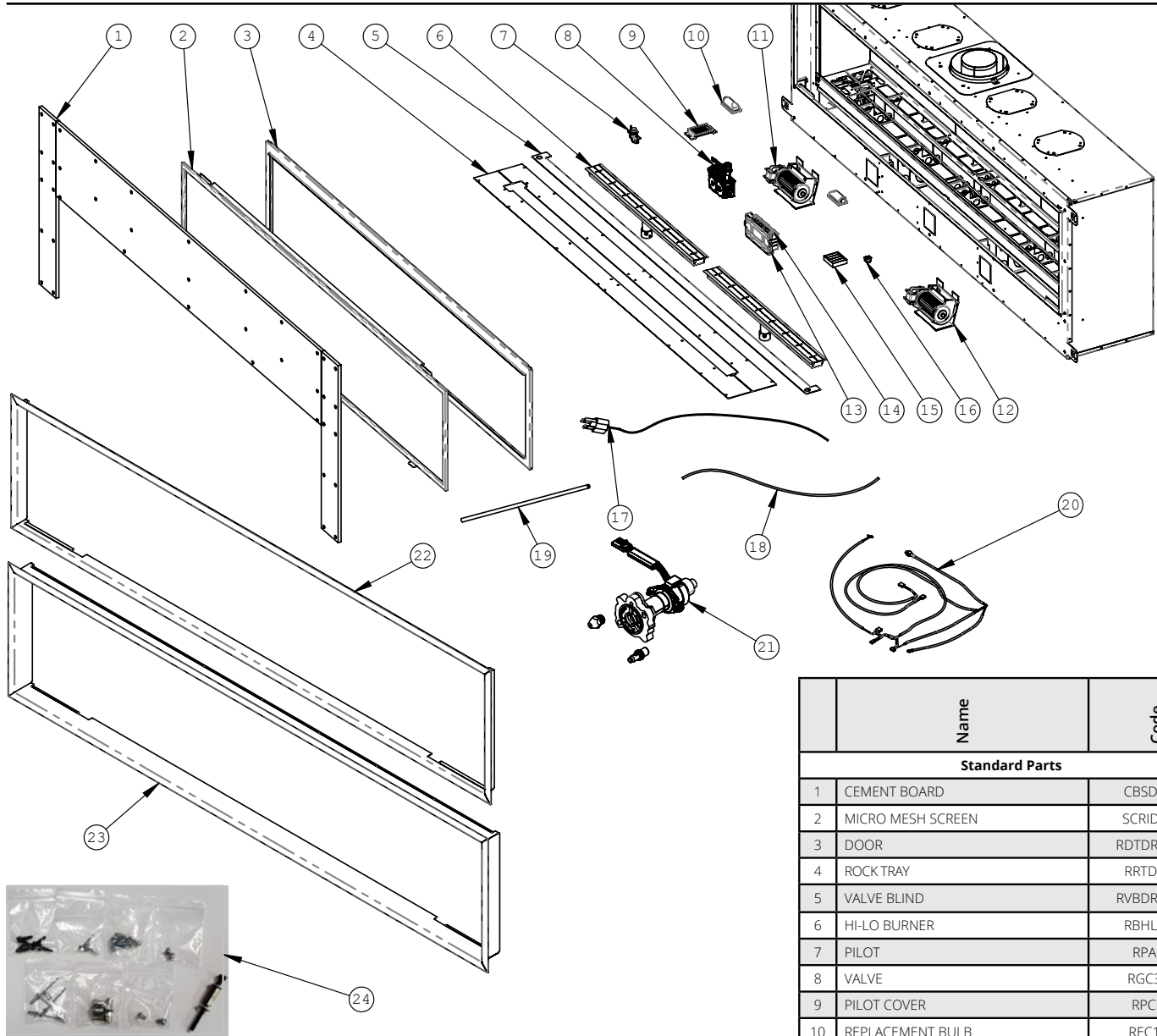

	Name	Code
Standard Parts		
1	CEMENT BOARD	CBSDRL72
2	MICRO MESH SCREEN	SCRIDRL72
3	DOOR	RDTDRL7213
4	ROCK TRAY	RRTDRL72
5	VALVE BLIND	RVBDRL7213
6	HI-LO BURNER	RBHL7213
7	PILOT	RPA035
8	VALVE	RGC3033
9	PILOT COVER	RPCDRL
10	REPLACEMENT BULB	REC1546
11	LEFT FAN	REC1377DRL
12	RIGHT FAN	REC1378DRL
13	PROFLAME 2 FULL CONTROL BOARD	RGC3104
14	FUSE 3.5A	REC1386
15	BATTERY HOLDER(4)	AF40BP
16	ON/OFF SWITCH	RECA015
17	POWER HARNESS	RECA131
18	PROFLAME 2 BOARD HARNESS	REC3062
19	PILOT TUBING 24"	RPTA03
26	PROFLAME 2 REMOTE/TRANSMITTER	RGC3105
27	REAR BLACK GLASS	RGL5127
28	SIDE BLACK GLASS	RGL5128
29	BLACK GLASS KIT DRL72	RGBDRL72

	Name	Code
Optional Parts		
20	DELRAY PV WIRE HARNESS	PVWH-SIT
21	LP CONVERSION KIT	GCA053
22	ADJUSTABLE TRIM KIT 0-11/16"	DRLT72
23	ADJUSTABLE TRIM KIT 1 1/2" - 2"	DRLT72-2
24	FASTENER REPAIR KIT	RKIT01
25	WALL MOUNT PROFLAME2 REMOTE	REC1550

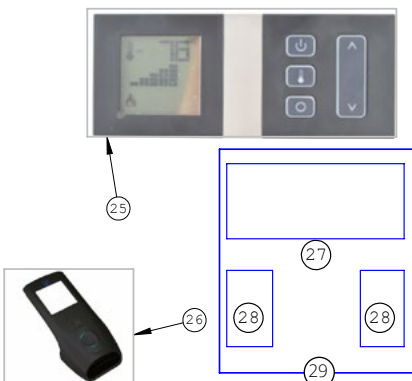

DelRay

Single Sided Gas Fireplace