



ENCLAVE

ZERO CLEARANCE DIRECT VENT BAY PENINSULA GAS FIREPLACE

Unit Illustrated: Model MQVLBG60NE2 Bay Peninsula Direct Vent Fireplace (Natural Gas), MQG5C Glass Media (Bronze x3), MQLOGF48D Driftwood Log Set, MQSTONE10 Decorative Stones. (Chase must be vented below and above appliance – consult manual for instructions).

 marquis
COLLECTION

CREATING A NEW DIMENSION

Its wraparound view captivates from every angle. Luring you in with its three-dimensional sightlines, the **ENCLAVE** from Marquis creates a sleek and cleverly designed gathering point for the heart of your home.

Amazingly versatile, this beguiling fireplace adapts to suit any room with options for a Single Side, Corner or a Bay Peninsula. It transforms completely with your choice of fireplace liner and accessories that range from driftwood logs and contemporary rocks to cannonballs and glass.

With the **ENCLAVE'S** innovative vented chase technology you may now cover the fireplace with combustible materials up to the glass door opening.

Follow the instructions in the manual for venting the chase (opening above and below the appliance is required).

Visit marquisfireplaces.net to see the latest evolution in fireplaces.

Unit Illustrated: Model MQVLB48NE2 Bay Peninsula Direct Vent Fireplace (Natural Gas), VL48EG Grill Kit for Enclosure, MQG5W Glass Media (White x2), MQVL48RGB Reflective Glass Liner (Black). (Chase must be vented below and above appliance – consult manual for instructions).





ENCLAVE 48 AND 60

STANDARD FEATURES

- LED Accent Lighting
- Proflame II Models include Remote Control with the following features: flame adjustment, thermostat, smart thermostat and accent lighting control
- Zero Clearances to TVs and Artwork
- Invisible Glass Safety Barrier



OPTIONAL FEATURES

Surround: Black or Stainless; Single-Sided Models only

Liner: Porcelain Reflective, Reflective Glass, Fluted Brick, or Stacked Brick

Media Options (Required): Glass Media (Glacier Ice, Cobalt Blue, Black, Bronze, White)

Additional Media (Optional): Cannonballs, Decorative Stones, Contemporary Rocks (natural and multi-colored), Ember Chunks.

Driftwood Log Sets: Four Piece Driftwood Set with Four Rocks, Three or Five Piece Driftwood Set, Three Piece Large Driftwood Set, or Six Piece Driftwood Log Set

Enclosure Grill: Unfinished

Corner Kit: Available for Bay Peninsula Unit

Side Extension Panels: Black; Single-Sided Models only

Heat Distribution System: Plenum (Enclave 48 only)

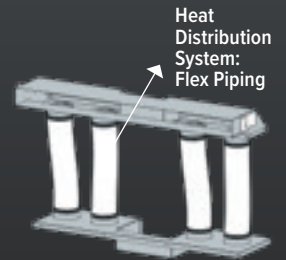

ENCLAVE 48



Unit Illustrated: Model MQVLB48NE2 Bay Peninsula Direct Vent Fireplace (Natural Gas), VLBC48 Corner Kit, MQG5C Glass Media (Bronze x2), MQSTONE Decorative Stones. (Chase must be vented below and above appliance – consult manual for instructions).

ADDITIONAL ENCLAVE 48 STYLES



MQVLB48NE2 Bay Peninsula Direct Vent Fireplace (Natural Gas), VLBCK48 Corner Kit, MQG5C Glass Media (Bronze x2), MQRB03 Driftwood Log Set.



MQVLB48NE2 Direct Vent Fireplace (Natural Gas), MQG5C Glass Media (Bronze x2), MQ46D Driftwood Log Set.

ENCLAVE 48 ADJUSTABLE VENTED PLATFORMS

Save on framing and adjust platform to your required height. Height is variable from 14³/₁₆" to 27¹/₄". Ventilation Slots are provided at the bottom and between the fireplace and the platform.

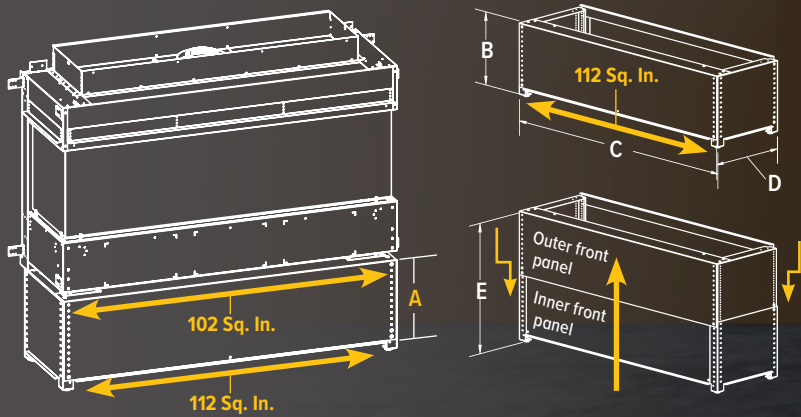

*NOTE: the fireplace chase must be vented both above and below appliance.

Unit Illustrated: Model MQVLB48NE2 Direct Vent Fireplace (Natural Gas), VL48EG Grill Kit for Enclosure, MQG5W Glass Media (White x2), MQVL48RGB Reflective Glass Liner (Black), MQVL48S1BL Surround (Black). (Chase must be vented below and above appliance – consult manual for instructions).

--- Room air coming IN
 --- Hot air coming OUT

Your choice of enclosure grill (front or sides) or top opening is required

Use any finish (including combustibles) right to the edge of the fireplace door opening

Design your own chase vent solution to suit your style*

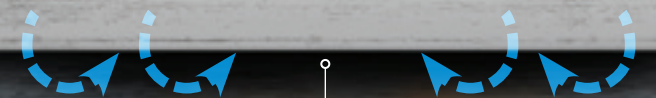

ENCLAVE 48 PRODUCT SPECIFICATIONS

MODEL	MQVLB48NE2	MQVLB48LPE2	MQVL48NE2	MQVL48LPE2
Type	BAY PENINSULA	BAY PENINSULA	SINGLE-SIDED	SINGE-SIDED
Fuel	Natural	Propane	Natural	Propane
Gas Control	IPI PF2	IPI PF2	IPI PF2	IPI PF2
Input Max.	35,000 BTU	35,000 BTU	35,000 BTU	35,000 BTU
Input Min.	25,000 BTU	27,000 BTU	25,000 BTU	27,000 BTU
Venting*	5/8"	5/8"	5/8"	5/8"
Glass Size	48" W x 17 7/8" H	48" W x 17 7/8" H	48" W x 17 7/8" H	48" W x 17 7/8" H
Glass Type	Ceramic	Ceramic	Ceramic	Ceramic
FE (P.4.1-15)	53.20%	53.20%	53.20%	53.20%

Ventilation Required:

THE FIREPLACE CHASE MUST BE VENTED BOTH ABOVE AND BELOW APPLIANCE**

ABOVE the appliance:
151 sq./in.

BELOW the appliance:
84 sq./in.

*This appliance is approved for use with 5/8" Kingsman Flex, M&G-DuraVent Direct Vent system (Model DV-GS Series) and Snorkel, BDM Pro Form Direct Vent, Ameri-Vent Direct Vent Pipe System, ICC Excel Direct, Metal Fab Sure-Seal DV and Selkirk Direct Temp. When using ICC Excel Direct a one-foot section of 5/8" MG DuraVent must be used as a starter collar at the flue of the appliance.

**Consult Installation Manual for further clarification.

PRODUCT DIMENSIONS

TOP VIEW

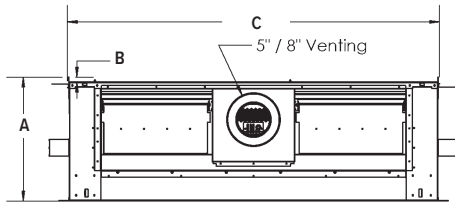

SIDE VIEW – SINGLE SIDED

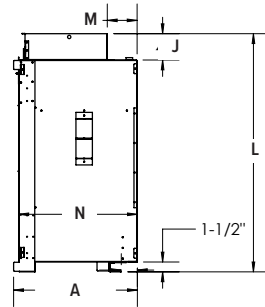

MQVL48

- A 18 13/16"
- B 3/4"
- C 56 1/2"
- D 9 3/4"
- E 46 3/8"
- F 54 15/16"
- G 36 5/16"
- H 15 1/4"
- I 9/16"
- J 4"
- K 7 5/16"
- L 36 1/4"
- M 4 9/16"
- N 18"
- O 15 1/4"
- P 8 1/4"
- Q 9 3/4"
- R 48"

FRONT VIEW

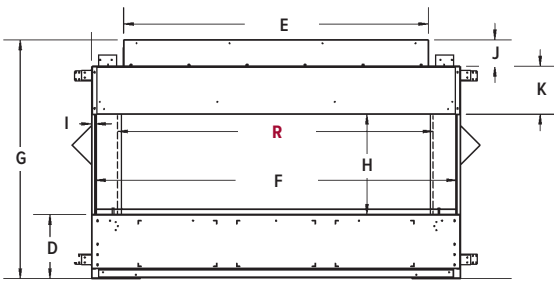

SIDE VIEW – BAY PENINSULA

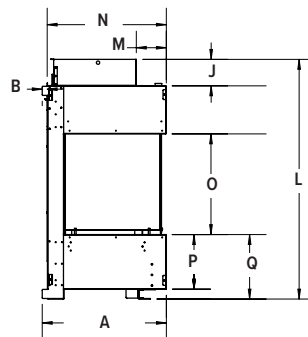

WALL SURROUND

FRONT VIEW

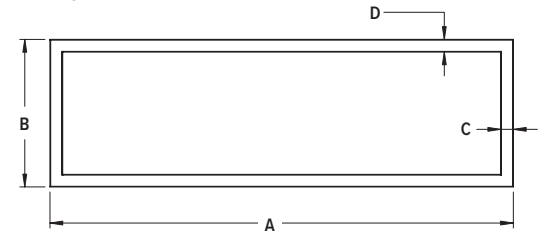

MQVL48S1

- A 58 1/16"
- B 18 1/2"
- C 1 1/2"
- D 1 1/2"

SIDE EXTENSION PANELS

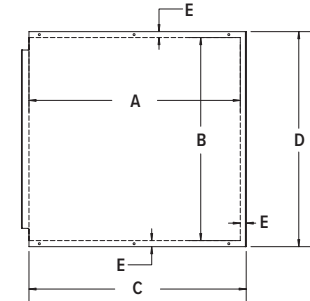

VL48SEP

- A 17 7/8"
- B 17 1/8"
- C 18 3/8"
- D 18 3/16"
- E 1/2"

FRONT ENCLOSURE GRILL

FRONT VIEW

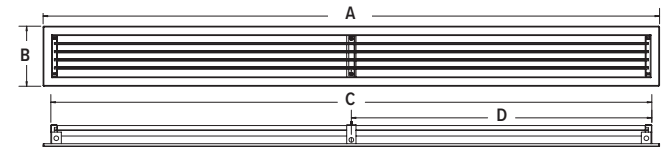

SIDE VIEW

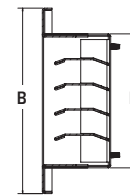

VL48EG

- A 49 3/4"
- B 4 13/16"
- C 48 1/2"
- D 24 1/4"
- E 3 1/2"

SIDE ENCLOSURE GRILL (PAIR)

FRONT VIEW

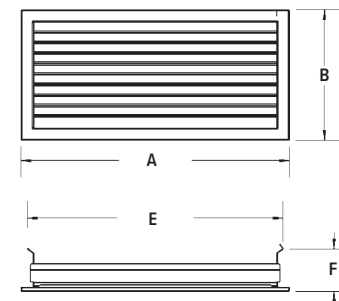

SIDE VIEW

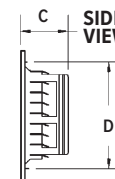

VL60EGS

- A 16 3/16"
- B 7 7/8"
- C 2 7/8"
- D 6 7/16"
- E 15 7/16"
- F 2 9/16"

ENCLAVE 60



Unit Illustrated: Model MQVLBG60NE2 Bay Peninsula Direct Vent Fireplace (Natural Gas), VL60EG Grill Kit for Enclosure, MQG5C Glass Media (Bronze x3), MQVL60RLSB Liner (Back – Stacked Brick). (Chase must be vented below and above appliance – consult manual for instructions).

Unit Illustrated: Model MQVLBG60NE2 Bay Peninsula Direct Vent Fireplace (Natural Gas), MQG5C Glass Media (Bronze x3), MQLOGF48D Driftwood Log Set, MQSTONE10 Decorative Stone, MQVL60RLSB Brick Liner (Stacked Brick).
(Chase must be vented below and above appliance – consult manual for instructions).



ADDITIONAL ENCLAVE 60 STYLES



MQVLBG60NE2 Bay Peninsula Direct Vent Fireplace (Natural Gas), MQG5C Glass Media (Bronze x3), MQVL60RLSB Stacked Brick Liner.



MQVLBG60NE2 Bay Peninsula Direct Vent Fireplace (Natural Gas), MQG5C Glass Media (Bronze x3), MQLOGF48D Driftwood Log Set, MQSTONE10 Decorative Stone (10 PCE), MQVL60RLSB Stacked Brick Liner.



MQVLBG60NE2 Bay Peninsula Direct Vent Fireplace (Natural Gas), MQG5C Glass Media (Bronze x3), MQRBD3 Driftwood Log Set (5 PCE), MQSTONE10 Decorative Stones (10 PCE), MQVL60RLSB Stacked Brick Liner.

ENCLAVE 60 ADJUSTABLE VENTED PLATFORMS

Save on framing and adjust platform to your required height. Height is variable from 15 1/8" to 27 1/8". Ventilation Slots are provided at the bottom and between the fireplace and the platform.

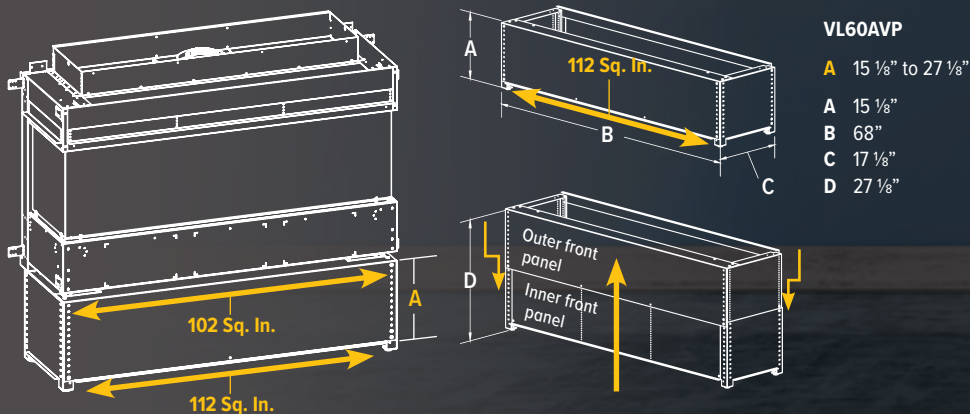

*NOTE: the fireplace chase must be vented both above and below appliance.

Unit Illustrated: Model MQVL60NE2 Direct Vent Fireplace (Natural Gas), MQG5C Glass Media (Bronze x3), RBCB1 Cannonballs. (Chase must be vented below and above appliance – consult manual for instructions).

Room air coming IN
Hot air coming OUT

Zero clearances to TVs and artwork

Use any finish (including combustibles) right to the edge of the fireplace door opening



Design your own chase vent solution to suit your style*

ENCLAVE 60 PRODUCT SPECIFICATIONS

MODEL	MQVLBG60NE2	MQVLBG60LPE2	MQVL60NE2	MQVL60LPE2
Type	BAY PENINSULA	BAY PENINSULA	SINGLE-SIDED	SINGE-SIDED
Fuel	Natural	Propane	Natural	Propane
Gas Control	IPI PF2	IPI PF2	IPI PF2	IPI PF2
Input Max.	45,000 BTU	44,000 BTU	45,000 BTU	44,000 BTU
Input Min.	32,000 BTU	35,000 BTU	32,000 BTU	35,000 BTU
Venting*	5/8"	5/8"	5/8"	5/8"
Glass Size	61 1/32" W x 17 7/8" H	61 1/32" W x 17 7/8" H	61 1/32" W x 17 7/8" H	61 1/32" W x 17 7/8" H
Glass Type	Ceramic	Ceramic	Ceramic	Ceramic
FE (P.4.1-15)	56.18%	56.52%	56.18%	56.52%

*This appliance is approved for use with 5/8" Kingsman Flex, M&G-DuraVent Direct Vent system (Model DV-GS Series) and Snorkel, BDM Pro Form Direct Vent, Ameri-Vent Direct Vent Pipe System, ICC Excel Direct, Metal Fab Sure-Seal DV and Selkirk Direct Temp. When using ICC Excel Direct a one-foot section of 5/8" MG DuraVent must be used as a starter collar at the flue of the appliance.

**Consult Installation Manual for further clarification.

PRODUCT DIMENSIONS

TOP VIEW

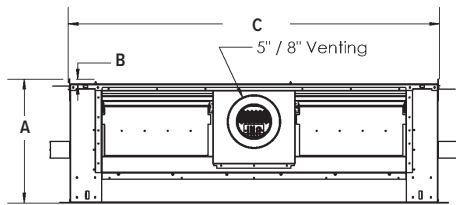

SIDE VIEW – SINGLE SIDED

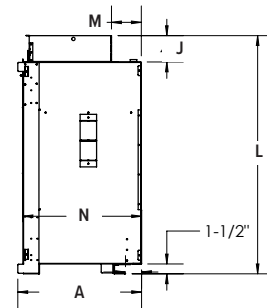

MQVL60
Single Side

A	20 1/16"
B	2"
C	68 1/2"
D	9 3/4"
E	58 1/2"
F	66 11/16"
G	36 5/16"
H	15 1/4"
I	1 1/16"
J	4"
K	7 5/16"
L	36 5/16"
M	4 9/16"
N	18"
O	15 1/4"
P	8 1/4"
Q	9 3/4"
R	60"

MQVLBG60
Bay Peninsula

FRONT VIEW

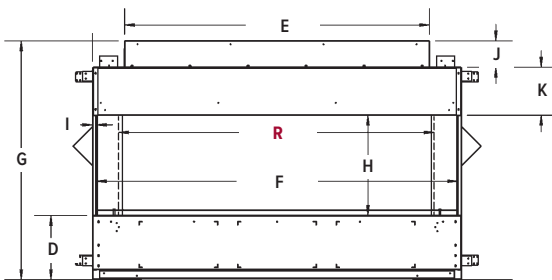

SIDE VIEW – BAY PENINSULA

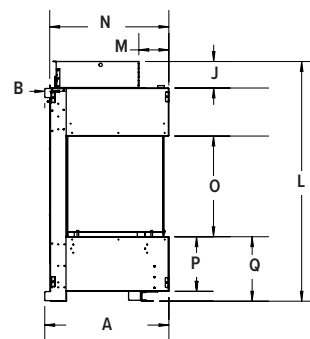

Ventilation Required:

THE FIREPLACE CHASE MUST BE VENTED BOTH ABOVE AND BELOW APPLIANCE**

ABOVE the appliance:
200 sq./in.

BELOW the appliance:
102 sq./in.

WALL SURROUND

FRONT VIEW

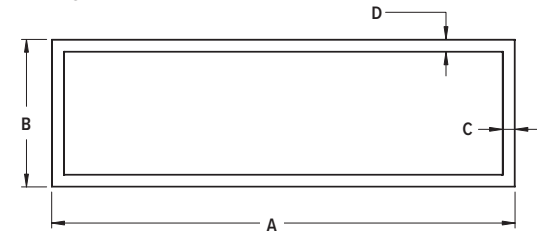

MQVL60S1

A	70 1/16"
B	18 1/2"
C	1 1/2"
D	1 1/2"

SIDE EXTENSION PANELS

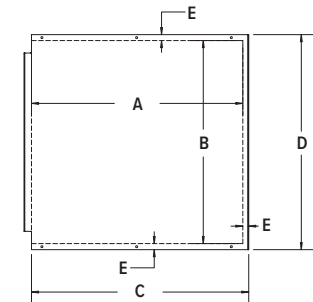

VL48SEP

A	17 7/8"
B	17 1/8"
C	18 3/8"
D	18 3/16"
E	1/2"

FRONT ENCLOSURE GRILL – VL60EG

FRONT VIEW

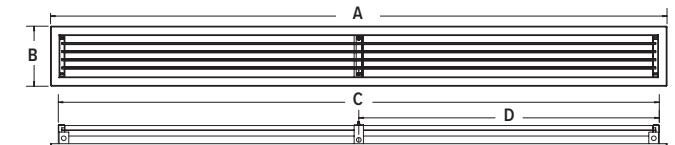

SIDE VIEW

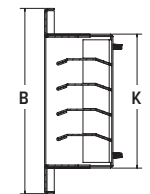

VL60EG

A	61 3/4"
B	4 7/8"
C	60 5/8"
D	30 5/16"
E	3 5/8"

SIDE ENCLOSURE GRILL – VL60EGS

FRONT VIEW

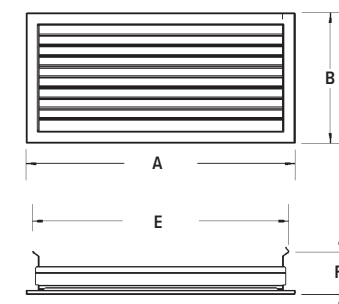

SIDE VIEW

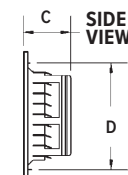

VL60EGS

A	16 3/16"
B	7 7/8"
C	2 7/8"
D	6 7/16"
E	15 7/16"
F	2 9/16"

ENCLAVE 48 AND 60 ACCESSORY OPTIONS

LOG SETS



MQ46D
3-Piece
Driftwood Set

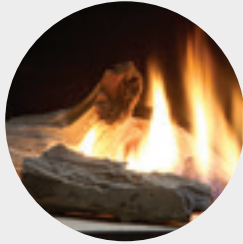

MQRBD1
4-Piece
Driftwood Set
with 4 Rocks

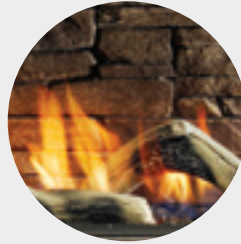

MQRBD3 (5-Piece)
or MQRBD4 (3-Piece)
Driftwood Set

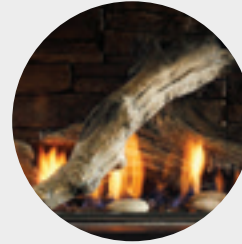

MQLOGF48D
6-Piece
Driftwood Set

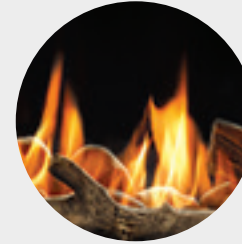

MQRBD2
3-Piece
Driftwood Set

MEDIA OPTIONS

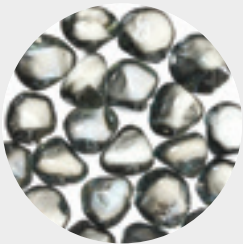

MQG5ZG
Zircon Glacier
Ice Glass

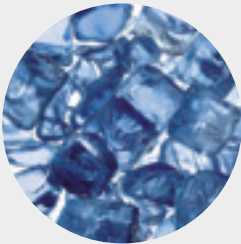

MQG5A
Cobalt
Ember Glass

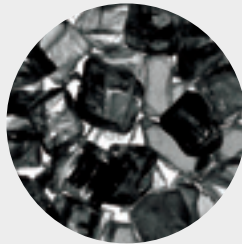

MQG5B
Black
Ember Glass

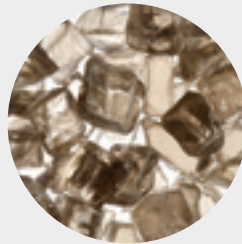

MQG5C
Bronze
Ember Glass



MQG5W
White
Ember Glass

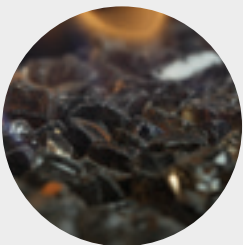

MQEMBER
Ember
Chunks



MQSTONE
Decorative
Stones



MQROCK2
Natural
Rock Set



MQROCK3
Multi-Colored
Rock Set



RBCB1
Multi-Colored
Cannonballs

LINERS

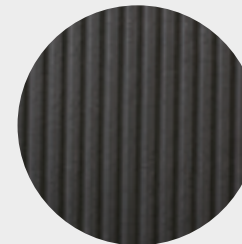

Fluted

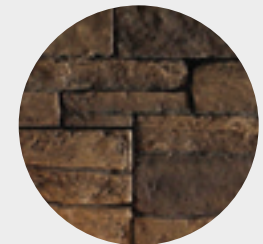

Stacked Brick

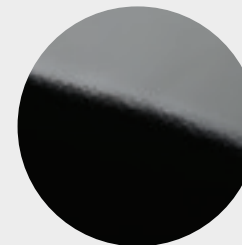

Porcelain
Reflective
Liner

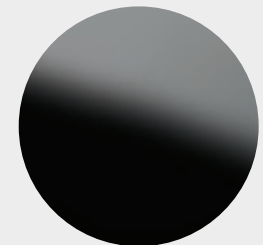

Glass
Reflective
Liner

Unit Illustrated: Model MQVLBG60NE2 Bay Peninsula Direct Vent Fireplace (Natural Gas), VLBGCK Corner Kit, MQG5C Glass Media (Bronze x3), MQRBD3 Driftwood Log Set, MQSTONE10 Decorative Stone (10 piece), MQVL60RLSB Refractory Liner (Back – Stacked Brick). (Chase must be vented below and above appliance – consult manual for instructions).



Marquis Fireplaces maintains a program of continuous testing, refinement and improvements of all its products. Some aspect of units shown here may be changed at any time without notice or obligation.

Certification: USA and Canada. Certified to: ANSI Z21.88-2016; CSA 2.33-2016 VENTED GAS FIREPLACE HEATER.

Note: Components may have to be ordered separately to create a complete unit. Discuss with your local Marquis Dealer for clarification.



FOR CALIFORNIA RESIDENTS ONLY:
WARNING! This product can expose you to chemicals including Carbon Monoxide, that is an externally vented by-product of fuel consumption, which is [are] known to the State of California to cause birth defects or other reproductive harm. For more information, visit www.P65Warnings.ca.gov.

Crafted entirely in Canada, each Marquis fireplace is built to the highest standards and made to last.



LIMITED LIFETIME WARRANTY

2340 Logan Avenue
Winnipeg, Manitoba, CAN
R2R 2V3
Phone: 204.632.1962
Fax: 204.632.1960
marquisfireplaces.net

Printed in Canada
B100 – 07/19

Canada

ENERGUIDE

Look for the **EnerGuide**
Gas Fireplace Energy
Efficiency Rating in this brochure

Based on CSA P.4.1-15