



**Unit Illustrated:** Model MQVLBG60NE2 Bay Peninsula Direct Vent Fireplace (Natural Gas), MQG5C Glass Media (Bronze x3), MQVL60RGB Reflective Glass Liner (Back). (Chase must be vented below and above appliance – consult manual for instructions).

# ENCLAVE

ZERO CLEARANCE DIRECT VENT BAY PENINSULA  
GAS FIREPLACE



# CREATING A NEW DIMENSION

Its wraparound view captivates from every angle. Luring you in with its three-dimensional sightlines, the **ENCLAVE** from Marquis creates a sleek and cleverly designed gathering point for the heart of your home.

Amazingly versatile, this beguiling fireplace adapts to suit any room with options for a Single Side, Corner or a Bay Peninsula. It transforms completely with your choice of fireplace liner and accessories that range from driftwood logs and contemporary rocks to cannonballs and glass.

With the **ENCLAVE'S** innovative vented chase technology you may now cover the fireplace with combustibile materials up to the glass door opening.

Follow the instructions in the manual for venting the chase (opening above and below the appliance is required).

Visit [marquisfireplaces.net](http://marquisfireplaces.net) to see the latest evolution in fireplaces.

## ENCLAVE FEATURES

### STANDARD

- LED Accent Lighting (non-dimmable)
- Proflame II Models include Remote Control with the following features: flame adjustment, thermostat, smart thermostat and accent lighting control
- Zero Clearances to TVs and Artwork
- Invisible Glass Safety Barrier

### BENEFITS OF OUR VENTED CHASE TECHNOLOGY

- No fans required to vent the chase, will work during power failures (batteries required)
- Allows for all wood framing
- Combustible materials may be used right up to the glass door opening
- Seamless glass, removes the need for steel safety screen barrier
- Allows for reduced mantel clearances
- Ultra-low TV clearances



PF2

### OPTIONAL

#### Surround:

Black or Stainless; Single-Sided Models only

#### Liner:

Porcelain Reflective, Reflective Glass, Fluted Brick, or Stacked Brick

#### Media Options (Required):

Glass Media (Glacier Ice, Cobalt Blue, Black, Bronze, White)

#### Additional Media (Optional):

Cannonballs, Decorative Stones, Contemporary Rocks (natural and multi-colored), Ember Chunks.

#### Log Sets:

4 Piece Driftwood Set with 4 Rocks, 3 or 5 Piece Driftwood Set, 3 Piece Large Driftwood Set, 6 Piece Driftwood Set, or Birch Set.

#### Enclosure Grills:

Front or Sides – Unfinished

#### Corner Kit:

Available for Bay Peninsula Unit

#### Side Extension Panels:

Black; Single-Sided Models only

#### Heat Distribution System:

Plenum (Enclave 48 only)

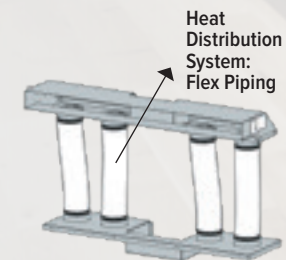



Unit Illustrated: Model MOVLBG48NE2 Bay Peninsula Direct Vent Fireplace (Natural Gas), VL48EG Grill Kit for Enclosure, MORBRW Birch Log Set, MOG5C Glass Media (Bronze x2), MQSTONE10 Decorative Stones, MQVL48RGB Reflective Glass Liner (Back). (Chase must be vented below and above appliance – consult manual for instructions).

## ENCLAVE 48



MQVLBG48NE2 Bay Peninsula Direct Vent Fireplace (Natural Gas), VLBGCK Corner Kit, MQG5C Glass Media (Bronze x2), MQRBD3 Driftwood Log Set.



MQVLBG48NE2 Direct Vent Fireplace (Natural Gas), VLBGCK Corner Kit, MQG5C Glass Media (Bronze x2), MQ46D Driftwood Log Set, MQVL48RGB Reflective Glass Liner (Back).



MQVLBG48NE2 Direct Vent Fireplace (Natural Gas), MQG5C Glass Media (Bronze x2), MQVL48RLFB2 Fluted Brick Liner (Back)



**Unit Illustrated:** Model MQVLBG48NE2 Bay Peninsula Direct Vent Fireplace (Natural Gas), VLBGCK Corner Kit, MQG5C Glass Media (Bronze x2), MQSTONE Decorative Stones, MQVL48RGB Reflective Liner (Back) and MQVL48RGE Reflective Glass Liner (Ends). (Chase must be vented below and above appliance – consult manual for instructions).

## ENCLAVE 48 ADJUSTABLE VENTED PLATFORMS

Save on framing and adjust platform to your required height. Height is variable from 15" to 27". Ventilation Slots are provided at the bottom and between the fireplace and the platform.

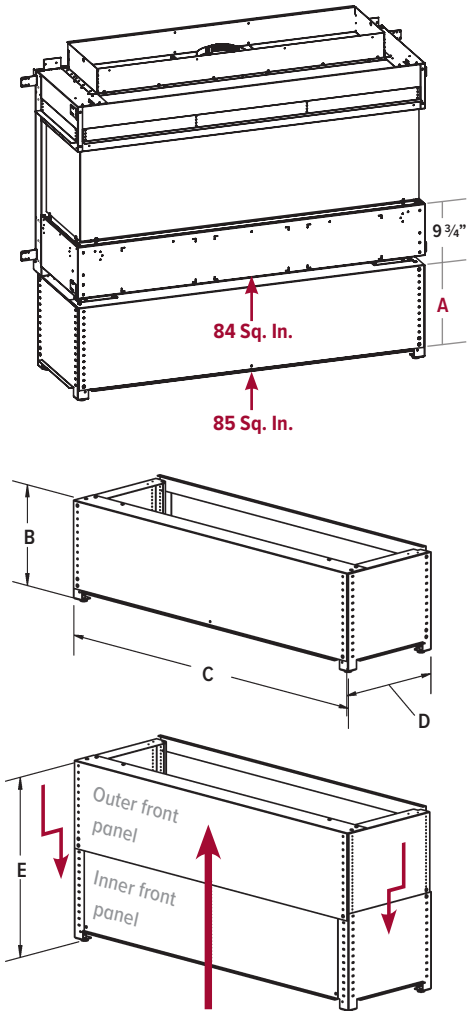

### VL48AVP

- A 15" to 27"
- B 15"
- C 56"
- D 17 1/8"
- E 27"

NOTE: the fireplace chase must be vented both above and below appliance, no fans are required.

Unit Illustrated: Model MQVL48NE2 Direct Vent Fireplace (Natural Gas), VL48EG Grill Kit for Enclosure, MQG5W Glass Media (White x2), MQVL48RGB Reflective Glass Liner (Back), MQVL48RGE Reflective Glass Liner (Ends), MQVL48S1BL Surround (Black). (Chase must be vented below and above appliance – consult manual for instructions).

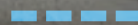
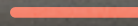
 Room air coming **IN**  
 Hot air coming **OUT**

Your choice of enclosure grill (front or sides) or top opening is required

Use any finish (including combustibles) right to the edge of the fireplace door opening

Design your own chase vent solution to suit your style\*

\*NOTE: the fireplace chase must be vented both above and below appliance.



## ENCLAVE 60



MQVLBG60NE2 Bay Peninsula Direct Vent Fireplace (Natural Gas), MQG5C Glass Media (Bronze x 3), MQLOGF48D Driftwood Log Set, MQSTONE10 Decorative Stone (10 PCE), MQVL60RLSB Stacked Brick Liner.



MQVLBG60NE2 Bay Peninsula Direct Vent Fireplace (Natural Gas), MQG5C Glass Media (Bronze x3), MQVL60RBRG Reflective Glass Liner (Back).

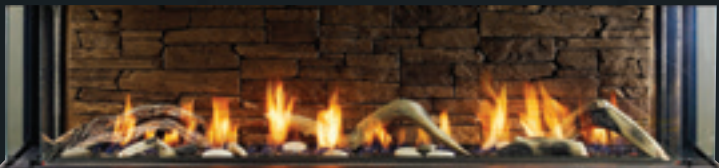

MQVLBG60NE2 Bay Peninsula Direct Vent Fireplace (Natural Gas), MQG5C Glass Media (Bronze x 3), MQRBD3 Driftwood Log Set (5 PCE), MQSTONE10 Decorative Stones (10 PCE), MQVL60RLSB Stacked Brick Liner.



**Unit Illustrated:** Model MQVLBG60NE2, Bay Peninsula Direct Vent Fireplace (Natural Gas), VL60EG Grill Kit for Enclosure, MQG5C Glass Media (Bronze x3), MQVL60RLSB Stacked Brick Liner. (Chase must be vented below and above appliance – consult manual for instructions).

## ENCLAVE 60 ADJUSTABLE VENTED PLATFORMS

Save on framing and adjust platform to your required height. Height is variable from 15" to 27". Ventilation Slots are provided at the bottom and between the fireplace and the platform.

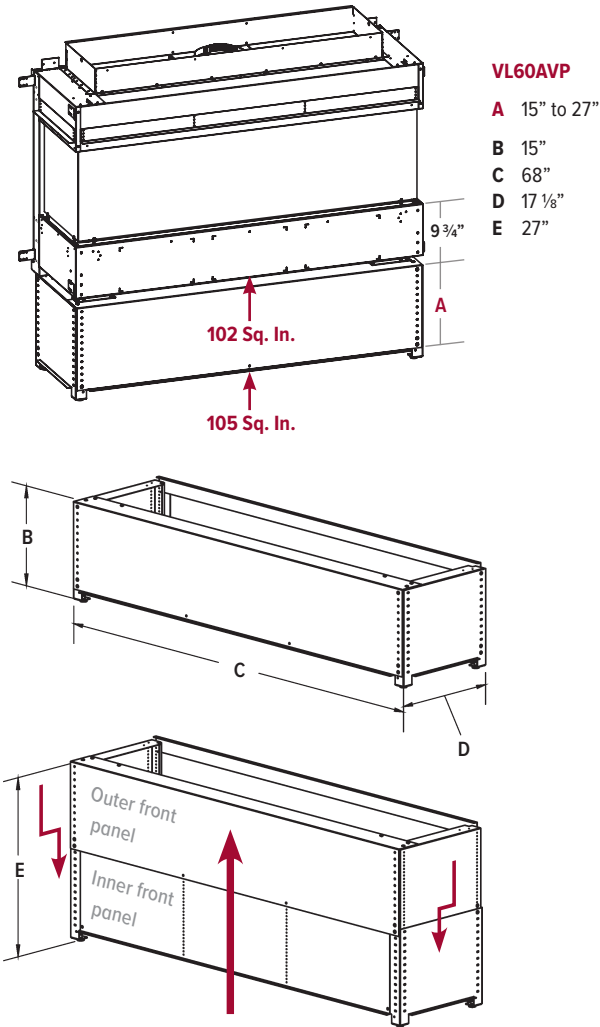

**NOTE:** the fireplace chase must be vented both above and below appliance, no fans are required.

**Unit Illustrated:** Model MQVL60NE2 Direct Vent Fireplace (Natural Gas), MQG5C Glass Media (Bronze x3), RBCB1 Cannonballs, MQVL60RGB Reflective Glass Liner (Back), MQVL48RGE Reflective Glass Liner (End). (Chase must be vented below and above appliance – consult manual for instructions).



Zero clearances to TVs and artwork

Use any finish (including combustibles) right to the edge of the fireplace door opening



## ENCLAVE 72



MQVLBG72NE2 Bay Peninsula Direct Vent Fireplace (Natural Gas), MQG5W Glass Media (White x3), MQVL72RGB Reflective Glass Liner (Back).



MQVL72NE2 Single Side Direct Vent Fireplace (Natural Gas), MQG5A Glass Media (Cobalt x3), MQVL72RGB Reflective Glass Liner (Back).



MQVLBG72NE2 Bay Peninsula Direct Vent Fireplace (Natural Gas), MQG5C Glass Media (Bronze x3), MQLOGF48D Driftwood Log Set, MQSTONE10 Decorative Stones (10 piece), MQVL72RGB Reflective Glass Liner (Back).



**Unit Illustrated:** Model MQVLBG72NE2 Bay Peninsula Direct Vent Fireplace (Natural Gas), MQG5W Glass Media (White x3), MQLOGF48D Driftwood Log Set, MQSTONE10 Decorative Stone (10 piece), MQVL72RGB Reflective Glass Liner (Back). (Chase must be vented below and above appliance – consult manual for instructions).



## ENCLAVE 72 ADJUSTABLE VENTED PLATFORMS

Save on framing and adjust platform to your required height. Height is variable from 15" to 27". Ventilation Slots are provided at the bottom and between the fireplace and the platform.

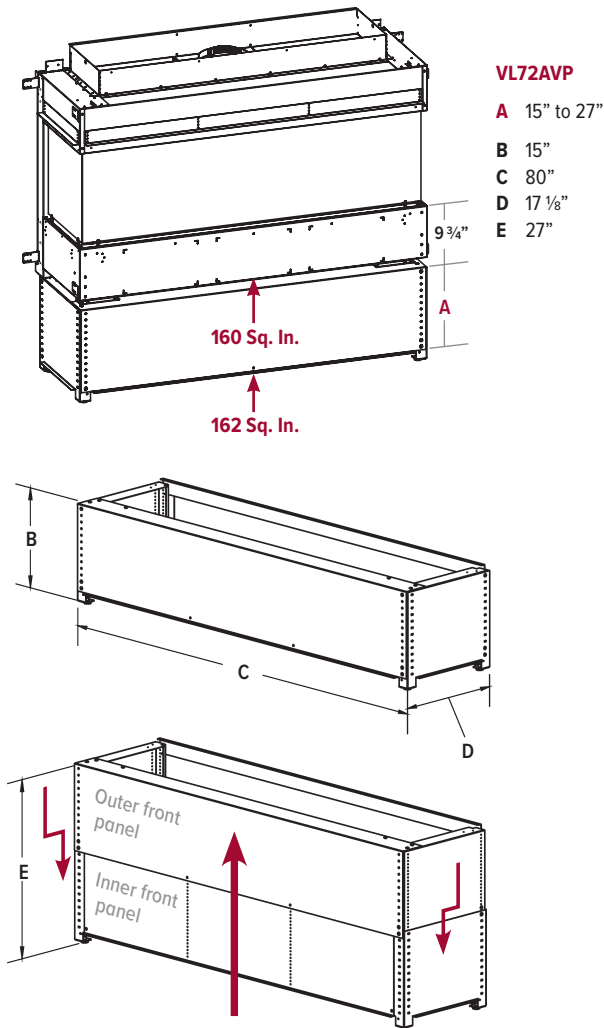

NOTE: the fireplace chase must be vented both above and below appliance, no fans are required.

Unit Illustrated: Model MQVL72NE2 Direct Vent Fireplace (Natural Gas), MQG5A Glass Media (Cobalt x3), MQVL72RGB Reflective Glass Liner (Back), VL72S1SS Surround (Stainless Steel). Shown with Optional VL72EG Grill (Front Enclosure x2). (Chase must be vented below and above appliance – consult manual for instructions).

Room air coming IN

Hot air coming OUT

Zero clearances to TVs, artwork and decorative elements

Use any finish (including combustibles) right to the edge of the fireplace opening

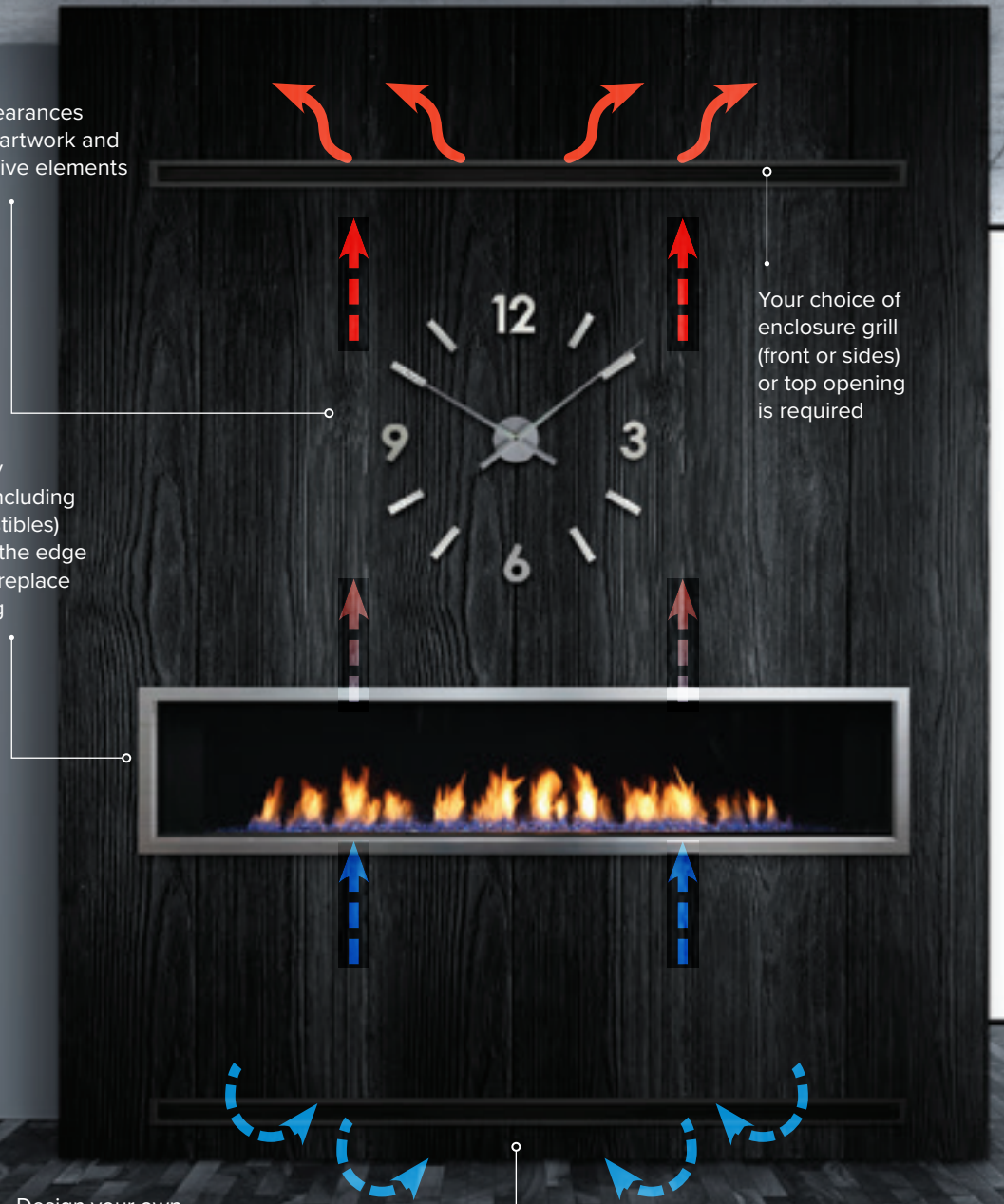

Design your own chase vent solution to suit your style\*

\*NOTE: the fireplace chase must be vented both above and below appliance.



**Unit Illustrated:** Model MQVLBG72NE2 Bay Peninsula Direct Vent Fireplace (Natural Gas), VLBGCK Corner Kit, MQG5W Glass Media (White x3), VL72EG Grill Kit for Enclosure, MQVL72RGB Reflective Glass Liner (Back). (Chase must be vented below and above appliance – consult manual for instructions).

# ENCLAVE PRODUCT SPECIFICATIONS

ENCLAVE 48

<b>MODEL</b>	MQVLBG48NE2	MQVLBG48LPE2	MQVL48NE2	MQVL48LPE2
<b>Type</b>	BAY PENINSULA	BAY PENINSULA	SINGLE-SIDED	SINGE-SIDED
<b>Fuel</b>	Natural Gas	Propane	Natural Gas	Propane
<b>Gas Control</b>	IPI PF2	IPI PF2	IPI PF2	IPI PF2
<b>Input Max.</b>	35,000 BTU	35,000 BTU	35,000 BTU	35,000 BTU
<b>Input Min.</b>	25,000 BTU	27,000 BTU	25,000 BTU	27,000 BTU
<b>Venting*</b>	5"8"	5"8"	5"8"	5"8"
<b>Glass Size</b>	49 1/16" W x 17 7/8" H	49 1/16" W x 17 7/8" H	49 1/16" W x 17 7/8" H	49 1/16" W x 17 7/8" H
<b>Glass Type</b>	Ceramic	Ceramic	Ceramic	Ceramic
<b>FE (P.4.1-15)</b>	53.20%	53.20%	53.20%	53.20%

**Ventilation Required:**

**THE FIREPLACE CHASE MUST BE VENTED BOTH ABOVE AND BELOW APPLIANCE\*\***

**ABOVE the appliance:**  
151 sq./in.

**BELOW the appliance:**  
84 sq./in.

ENCLAVE 60

<b>MODEL</b>	MQVLBG60NE2	MQVLBG60LPE2	MQVL60NE2	MQVL60LPE2
<b>Type</b>	BAY PENINSULA	BAY PENINSULA	SINGLE-SIDED	SINGE-SIDED
<b>Fuel</b>	Natural Gas	Propane	Natural Gas	Propane
<b>Gas Control</b>	IPI PF2	IPI PF2	IPI PF2	IPI PF2
<b>Input Max.</b>	45,000 BTU	44,000 BTU	45,000 BTU	44,000 BTU
<b>Input Min.</b>	32,000 BTU	35,000 BTU	32,000 BTU	35,000 BTU
<b>Venting*</b>	5"8"	5"8"	5"8"	5"8"
<b>Glass Size</b>	61 1/32" W x 17 7/8" H	61 1/32" W x 17 7/8" H	61 1/32" W x 17 7/8" H	61 1/32" W x 17 7/8" H
<b>Glass Type</b>	Ceramic	Ceramic	Ceramic	Ceramic
<b>FE (P.4.1-15)</b>	56.18%	56.52%	56.18%	56.52%

**Ventilation Required:**

**THE FIREPLACE CHASE MUST BE VENTED BOTH ABOVE AND BELOW APPLIANCE\*\***

**ABOVE the appliance:**  
200 sq./in.

**BELOW the appliance:**  
102 sq./in.

ENCLAVE 72

<b>MODEL</b>	MQVLBG72NE2	MQVLBG72LPE2	MQVL72NE2	MQVL72LPE2
<b>Type</b>	BAY PENINSULA	BAY PENINSULA	SINGLE-SIDED	SINGE-SIDED
<b>Fuel</b>	Natural Gas	Propane	Natural Gas	Propane
<b>Gas Control</b>	IPI PF2	IPI PF2	IPI PF2	IPI PF2
<b>Input Max.</b>	50,000 BTU	50,000 BTU	50,000 BTU	50,000 BTU
<b>Input Min.</b>	34,000 BTU	39,000 BTU	34,000 BTU	39,000 BTU
<b>Venting*</b>	5"8"	5"8"	5"8"	5"8"
<b>Glass Size</b>	73 1/16" W x 17 7/8" H	73 1/16" W x 17 7/8" H	73 1/16" W x 17 7/8" H	73 1/16" W x 17 7/8" H
<b>Glass Type</b>	Ceramic	Ceramic	Ceramic	Ceramic
<b>FE (P.4.1-15)</b>	60.32%	60.32%	60.32%	60.32%

**Ventilation Required:**

**THE FIREPLACE CHASE MUST BE VENTED BOTH ABOVE AND BELOW APPLIANCE\*\***

**ABOVE the appliance:**  
285 sq./in.

**BELOW the appliance:**  
158 sq./in.

*\*This appliance is approved for use with 5"8" Kingsman Flex, M&G-Duravent Direct Vent system (Model DV-GS Series) and Snorkel, BDM Pro Form Direct Vent, Ameri-Vent Direct Vent Pipe System, ICC Excel Direct, Metal Fab Sure-Seal DV and Selkirk Direct Temp. When using ICC Excel Direct a one-foot section of 5"8" MG Duravent must be used as a starter collar at the flue of the appliance.*

*\*\*Consult Installation Manual for further clarification.*

# ENCLAVE PRODUCT SPECIFICATIONS

## DIMENSIONS

<b>MQVL48</b> Single Side	<b>MQVLBG48</b> Bay Peninsula	<b>MQVL60</b> Single Side	<b>MQVLBG60</b> Bay Peninsula	<b>MQVL72</b> Single Side	<b>MQVLBG72</b> Bay Peninsula
<b>A</b> 18 13/16"	18 13/16"	<b>A</b> 20 1/16"	20 1/16"	<b>A</b> 18 13/16"	18 7/8"
<b>B</b> 56 1/2"	56 1/2"	<b>B</b> 68 1/2"	68 1/2"	<b>B</b> 80 1/2"	80 1/2"
<b>C</b> 36 5/16"	36 5/16"	<b>C</b> 36 5/16"	36 5/16"	<b>C</b> 36 5/16"	36 5/16"
<b>D</b> 46 3/8"	46 3/8"	<b>D</b> 58 1/2"	58 1/2"	<b>D</b> 70 1/2"	70 1/2"
<b>E</b> 54 15/16"	54 15/16"	<b>E</b> 66 1/4"	66 5/8"	<b>E</b> 78 5/8"	78 5/8"
<b>F</b> 49 1/16"	49 1/16"	<b>F</b> 61 1/32"	61 1/32"	<b>F</b> 73 3/16"	73 3/16"
<b>G</b> 9 3/4"	9 3/4"	<b>G</b> 9 3/4"	9 3/4"	<b>G</b> 9 3/4"	9 3/4"
<b>H</b> 15 1/4"	15 1/4"	<b>H</b> 15 1/4"	15 1/4"	<b>H</b> 15 1/4"	15 1/4"
<b>I</b> 9/16"	—	<b>I</b> 1 1/16"	3/4"	<b>I</b> 1 1/16"	3/4"
<b>J</b> 4"	4"	<b>J</b> 4"	4"	<b>J</b> 4"	4"
<b>K</b> 7 5/16"	7 1/4"	<b>K</b> 7 5/16"	7 5/16"	<b>K</b> 7 5/8"	7 5/16"
<b>L</b> 4 9/16"	4 9/16"	<b>L</b> 4 9/16"	4 9/16"	<b>L</b> 4 9/16"	4 9/16"
<b>M</b> 18"	18"	<b>M</b> 18"	18"	<b>M</b> 18 7/8"	18 7/8"
<b>N</b> 36 1/4"	36 1/4"	<b>N</b> 36 5/16"	36 5/16"	<b>N</b> 36 5/16"	36 5/16"
<b>O</b> 8 1/4"	8 1/4"	<b>O</b> 8 1/4"	8 1/4"	<b>O</b> 8 1/4"	8 1/4"

TOP VIEW

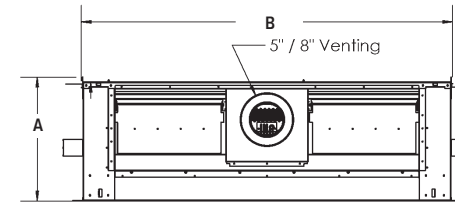

SIDE VIEW – SINGLE SIDED

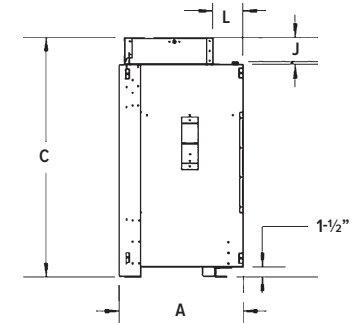

FRONT VIEW

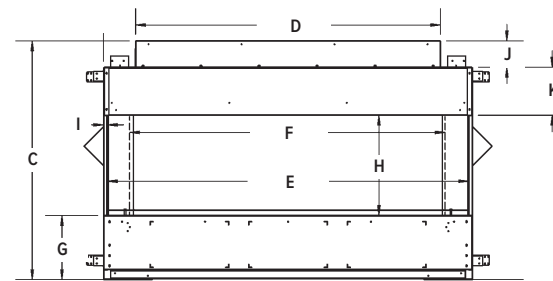

SIDE VIEW – BAY PENINSULA

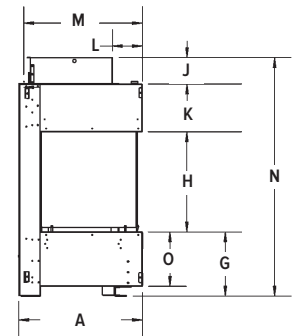

## WALL SURROUND

FRONT VIEW

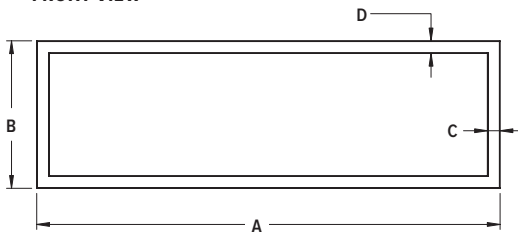

<b>VL48S1</b>	<b>VL60S1</b>	<b>VL72S1</b>
<b>A</b> 58 1/16"	70 1/16"	82 1/16"
<b>B</b> 18 1/2"	18 1/2"	18 1/2"
<b>C</b> 1 1/2"	1 1/2"	1 1/2"
<b>D</b> 1 1/2"	1 1/2"	1 1/2"

## SIDE EXTENSION PANELS

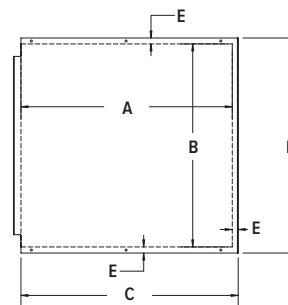

<b>VL48SEP</b>
<b>A</b> 17 7/8"
<b>B</b> 17 1/8"
<b>C</b> 18 3/8"
<b>D</b> 18 3/16"
<b>E</b> 1/2"

## VLBGCK CORNER KIT

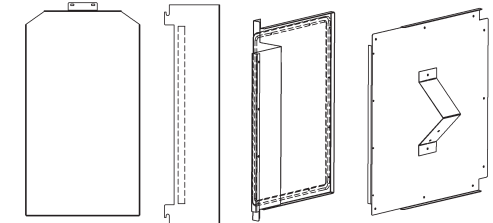

**Unit Illustrated:** Model MQVLBG60NE2 Bay Peninsula Direct Vent Fireplace (Natural Gas), MQG5C Glass Media (Bronze x3), MQLOGF48D Driftwood Log Set, MQSTONE10 Decorative Stone, MQVL60RLSB Brick Liner (Stacked Brick). (Chase must be vented below and above appliance – consult manual for instructions).

## FRONT ENCLOSURE GRILL

FRONT/TOP VIEW – VL48EG

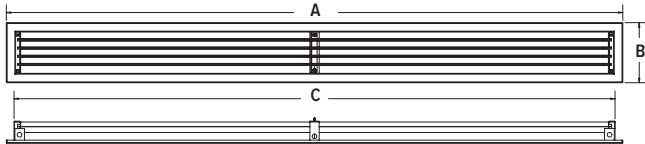

FRONT/TOP VIEW – VL60EG/VL72EG

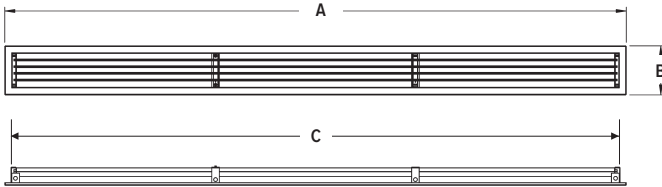

SIDE VIEW

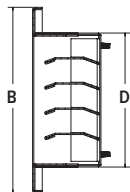

	VL48EG	VL60EG	VL72EG
A	49 3/4"	61 3/4"	79 3/4"
B	4 13/16"	4 7/8"	4 7/8"
C	48 1/2"	60 1/2"	78 5/8"
D	3 1/2"	3 5/8"	3 5/8"

## SIDE ENCLOSURE GRILL (PAIR)

FRONT VIEW

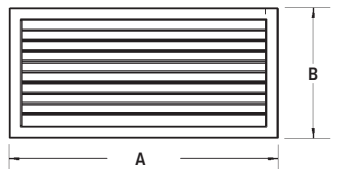

TOP VIEW

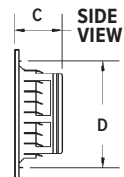

	VL60EGS	VL72EGS
A	16 3/16"	16 3/16"
B	7 7/8"	10 3/8"
C	2 7/8"	2 7/8"
D	6 7/16"	8 15/16"
E	15 7/16"	15 7/16"
F	2 9/16"	2 7/8"



# ENCLAVE ACCESSORIES

## LOG SETS



**MQ46D (3-Piece)**  
Driftwood Set



**MQRBD1 (4-Piece)**  
Driftwood Set with 4 Rocks



**MQRBD3 (5-Piece) / MQRBD4 (3-Piece)**  
Driftwood Set



**MQLOGF48D (6-Piece)**  
Driftwood Set



**MQRBD2 (3-Piece)**  
Driftwood Set



**MQRBRW (5-Piece)**  
Birch Log Set

MEDIA OPTIONS

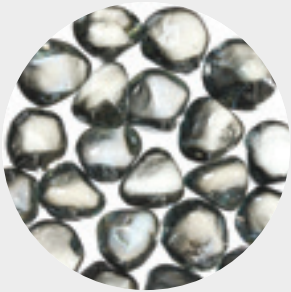

**MQG5ZG**  
Zircon Glacier Ice Glass

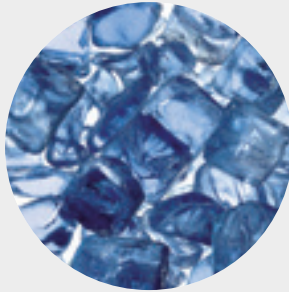

**MQG5A**  
Cobalt Ember Glass

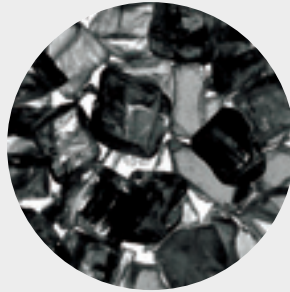

**MQG5B**  
Black Ember Glass

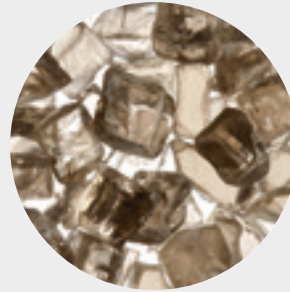

**MQG5C**  
Bronze Ember Glass



**MQG5W**  
White Ember Glass



**MQEMBER**  
Ember Chunks



**MQSTONE**  
Decorative Stones



**MQROCK2**  
Natural Rock Set



**MQROCK3**  
Multi-Colored Rock Set



**RBCB1**  
Multi-Colored Cannonballs

LINERS



Fluted

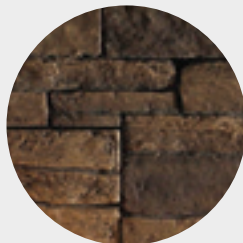

Stacked Brick

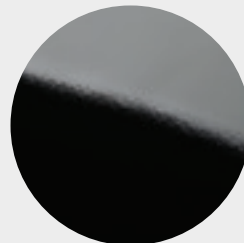

Porcelain Reflective

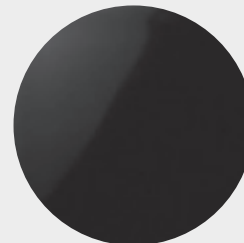

Glass Reflective

**Unit Illustrated:** Model MQVLBG60NE2 Bay Peninsula Direct Vent Fireplace (Natural Gas), VLBGCK Corner Kit, MQG5C Glass Media (Bronze x3), MQRBD3 Driftwood Log Set, MQSTONE10 Decorative Stone (10 piece), MQVL60RLSB Refractory Liner (Back – Stacked Brick).  
(Chase must be vented below and above appliance – consult manual for instructions).



Marquis Fireplaces maintains a program of continuous testing, refinement and improvements of all its products. Some aspect of units shown here may be changed at any time without notice or obligation.

Certification: Certified to ANSI Z21.88-2017, CSA 2.33-2017 Vented Gas Fireplace Heaters.

Note: Components may have to be ordered separately to create a complete unit. Discuss with your local Marquis Dealer for clarification.

Canada

**ENERGUIDE**

Look for the **EnerGuide** Gas Fireplace Energy Efficiency Rating in this brochure

Based on CSA P.4.1-15



**FOR CALIFORNIA RESIDENTS ONLY:**  
**WARNING!** This product can expose you to chemicals including Carbon Monoxide, that is an externally vented by-product of fuel consumption, which is [are] known to the State of California to cause birth defects or other reproductive harm. For more information, visit [www.P65Warnings.ca.gov](http://www.P65Warnings.ca.gov).

Crafted entirely in Canada, each Marquis fireplace is built to the highest standards and made to last.

**LIMITED LIFETIME WARRANTY**



2340 Logan Avenue  
Winnipeg, Manitoba, CAN  
R2R 2V3  
Phone: 204.632.1962  
Fax: 204.632.1960  
[marquisfireplaces.net](http://marquisfireplaces.net)

Printed in Canada  
B100 – 05/2020