

Installation & Maintenance Manual

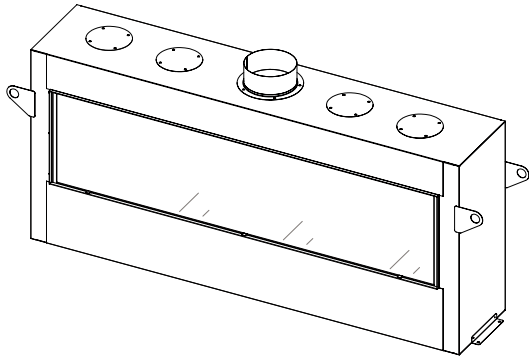

MONTIGO
the art of **fireplaces**

Distinction

DIRECT VENT INDOOR GAS FIREPLACE
DL6315, DL6315ST,
40,000 BTU/hr Natural Gas or Propane Gas

D6315, D6315ST
50,000 BTU/hr Natural Gas or Propane Gas



⚠ CAUTION

Installation and service must be performed by a qualified installer, service agency or the gas fitter. Check local codes and read all instructions prior to installation.

⚠ WARNING:
FIRE OR EXPLOSION HAZARD
Failure to follow safety warnings exactly could result in serious injury, death, or property damage.

- Do not store or use gasoline or other flammable vapors and liquids in the vicinity of this or any other appliance.
- WHAT TO DO IF YOU SMELL GAS
 - Do not try to light any appliance.
 - Do not touch any electrical switch; do not use any phone in your building.
 - Leave the building immediately.
 - Immediately call your gas supplier from a neighbour's phone. Follow the gas supplier's instructions.
 - If you cannot reach your gas supplier, call the fire department.
- Installation and service must be performed by a qualified installer, service agency or the gas fitter.

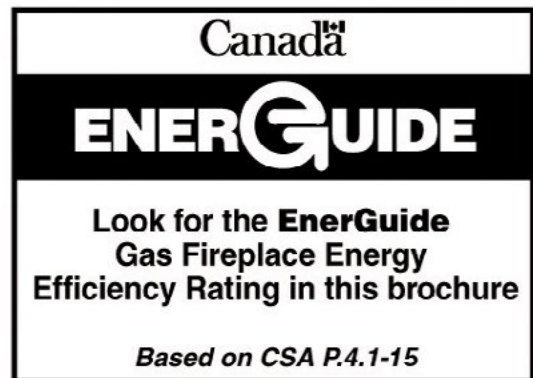

NOTICE

Installer: Leave this manual with the appliance. Please refer to the Montigo website for the most current version of the fireplaces manual
Consumer: Retain this manual for future reference. Please refer to the Montigo website for the most current version of the fireplaces manual

⚠ WARNING

Some materials used in the manufacturing process of this product can expose you to Benzene which is known in the State of California to cause cancer and birth defects or other reproductive harm. For more information go to www.P65warnings.ca.gov

Safety Alert Key



DANGER

Indicates a hazardous situation which, if not avoided, WILL result in death or serious injury or property damage.



WARNING

Indicates a hazardous situation which, if not avoided, COULD result in death or serious injury or property damage.



CAUTION

Indicates a hazardous situation which, if not avoided, WILL result in minor or moderate injury.

NOTICE

Addresses practices that are important, but not related to personal injury

Introduction

Congratulations on your purchase of a Montigo Fireplace.

With over 30 years of experience, Montigo is committed to providing you with a gas fireplace that is not only a beautiful addition to your space, but that is also designed and manufactured to the highest safety, reliability and engineering standards.

We strongly encourage you to read and carefully follow the instructions laid out in this Installation, Operation and Maintenance Manual and retain it for your future reference. Pay special attention to all cautions, warnings, and notices throughout this manual intended to ensure your safety.

This manual covers installation, operation and maintenance. Lighting, operation and care of this fireplace can be easily performed by the homeowner. All installation and service work should be performed by a qualified or licensed installer, plumber or gas fitter as certified by the state, province, region or governing body where the fireplace is being installed.

This installation, operation and maintenance manual is applicable to the models described in Table 1. Refer to your rating plate to verify included options.

Warranty and Installation Information: (See Appendix B)

The Montigo warranty will be voided by, and Montigo disclaims any responsibility for, the following actions:

- Modification of the fireplace and/or components including Direct-Vent assembly or glass doors.
- Use of any component part not manufactured or approved by Montigo in combination with this Montigo fireplace system.
- Installation other than as instructed in this manual.
- Consult your local Gas Inspection Branch on installation requirements for factory-built gas fireplaces. Installation & repairs should be done by a qualified contractor.

BTU and Efficiency

Unit Code	BTU		Single sided Efficiency	See through Efficiency
	High	Low	P.4. 1-15	P.4. 1-15
D6315NI-2	50,000	27,000	62.69%	63.57%
D6315LI-2	50,000	26,700	60.49%	62.94%
DL6315NI	40,000	40,000	61.22%	63.61%
DL6315LI	40,000	40,000	61.19%	61.57%

CAUTION

Young children should be carefully supervised when they are in the same room as the appliance. Toddlers, young children, and others may be susceptible to accidental contact burns. A physical barrier is recommended if there are at-risk individuals in the house. To restrict access to a fireplace or stove, install an adjustable safety gate to keep toddlers, young children, and other at-risk individuals out of the room and away from hot surfaces

Contents

Safety Alert Key	2	Section 8: Removing & Installing the Screen	35
Introduction	2	Removing the Screen	35
BTU and Efficiency	2	Reinstalling the Screen	35
Section A: Before You Begin	4	Removing & Installing the door.....	36
Installation Checklist.....	4	Removing the door:	36
Standard Installation Checklist	5	Reinstalling the door	36
Rating Plate Sample.....	6	Section 9: Installing the Fireglass.....	37
Section 1: Product Dimensions	7	Firestone & Fireglass Quantity.....	37
Section 2: Framing	9	Optional speckled stones	37
Combustible Wall Clearances	9	Optional Log Set.....	38
Raised Installation Framing - Single Sided	10	Log Kit Installation.....	38
Raised Installation Framing - See Through	10	D6315 (ST) (N/L) I-2 Wiring Diagram	40
Framing the Single Sided Fireplace (Floor Installation).....	11	LED Strip Instructions	42
Framing the See-Through Fireplace (Floor Installation).....	11	Glass reflective panels	43
Installing the Single Sided Fireplace	12	Fluted panels.....	43
Installing the See Through Fireplace.....	12	Before you begin:	45
Assemble Non Combustible Framing D/DL6315/ST (Detail).....	13	Section 7: Finishing the fireplace	47
Framing Box Assembly Single Sided.....	14	Initializing the System for the first time.....	49
Framing Box Assembly See-Through	14	Operating the System for the first time.....	49
Framing with Cool Wall Advantage	15	Temperature Indication Display.....	49
TV recess framing.....	15	Turn On the Fireplace	49
Section 3: Venting	16	Turn Off the Fireplace	49
Restrictor plate Installation.....	16	Remote-Flame Control.....	49
Section 3-3-1: Venting Layouts	17	Room Thermostat (Remote Control Operation).....	50
Vertical Termination	17	Smart Thermostat (Remote Control Operation)	50
Vertical Termination - 2 Elbows	17	Disabling Thermostat	50
Vertical Termination - 3 Elbows	18	Fan Speed Control	50
Horizontal Termination - 1 Elbow	18	Accent Light Control.....	50
Horizontal Termination - 2 Elbows	19	LED Remote Control Operation	51
Horizontal Termination - 3 Elbows	20	LED Troubleshooting.....	51
Section 3-2: Installing a Roof Mounted Direct Vent Termination (PVTK1SS).....	21	Pairing the Remote to the Module (Code Clearing and Code Matching).....	52
Section 3-2-1: Venting Layout	21	Section 10: Cleaning and Maintenance	53
Section 3-3: Installing a Wall Mounted Direct Vent Termination	22	General	53
Section 3-3-2: Venting Components	23	Cleaning.....	53
Section 3-3-2.2: Alternate Venting Components.....	24	Appendix A: Venting Terminations	54
Flexmaster as alternate venting	25	Appendix B: Warranty	55
Section 3-5: Heat Shields.....	26	Appendix B: Warranty Continued.....	56
Propane Conversion.....	28	Appendix C: Amendment.....	57
Section 4: Wiring	30	(Gas Fireplace / Equipment sold in the State of Massachusetts) 5.08: Modifications to NFPA-54, Chapter 10.....	57
D6315 (ST) (N/L) I-2 Wiring Diagram.....	30	Indoor fireplace in protected outdoor applications	58
Installation of Electrical Supply	30	See through fireplace.....	58
DL6315 (ST) (N/L) I Wiring Diagram	31	Notes.....	58
Installation of the wall switch	31	Single sided fireplace	58
POD - Pilot on Demand	32	Introduction to the Distinction Fireplace:	61
What is POD and CPI mode?	32	Section 6: Testing the system.....	62
Remote Continuous Pilot (CPI) Selection	32	6-1: Testing the system before gas connection.....	62
Installing the CPI Jumper Cable	32	6-2: Testing the system with gas connection (Highly recommended)	62
Section 5: Installing the gas line.....	33	6-2-2: LED Operation Verification – Applicable if light kit (MCLEDVO) is installed	62
Fuel Type.....	33	LED Remote Control Operation	64
Gas Pressure.....	33	Pairing the remote to the module	64
Gas Connection.....	33	(Code Clearing and Code Matching).....	64
Mantels & Surrounds	34	Optional Remote Operation	65
Mantels & Surrounds with Cool Wall Kit.....	34		
Finishing Around the Fireplace.....	34		

Section A: Before You Begin

IMPORTANT MESSAGE: SAVE THESE INSTRUCTIONS

The Distinction Series fireplaces must be installed in accordance with these instructions. Carefully read all the instructions in this manual first. Consult the Local Gas Branch to determine the need for a permit prior to starting the installation. It is the responsibility of the installer to ensure this fireplace is installed in compliance with the manufacturers instructions and all applicable codes.

NOTICE

Do not use this appliance if any part has been under water. Immediately call a qualified service technician to inspect the appliance and to replace any part of the control system and any gas control that has been under water

NOTICE

Due to high temperatures, the appliance should be located out of traffic and away from furniture and draperies

NOTICE

Children and adults should be alerted to the hazards of high surface temperature and should stay away to avoid burns or clothing ignition

NOTICE

A barrier designed to reduce the risk of burns from the hot viewing glass is provided with this appliance and shall be installed for the protection of children and other at-risk individuals

Installation Checklist

- Determine the desired install location of your fireplace.
- See Section 1, Dimensions on Page 8, and refer to the Framing Section 2 for details.
- Select the location of your termination and resulting vent run.
- Your selected termination location must be the highest point in the Direct Vent installation.
- Should it be impossible to meet the venting requirements laid out in Section 3: Venting, please contact your Montigo dealer regarding the use of a Montigo Power Vent.
- Lay out the Vent run; calculating the required elbows and straight runs of 5"/8" flex and/or rigid pipe.
- Layout Electrical Requirements refer to Section 4: Wiring, for Details.
- Refer to Section 5: Installing the Gas Line, for details on the gas connection and access.
- Refer to local codes and guidelines for installation requirements.
- Installation and repairs should be done by a qualified contractor and must conform to:
- Installations in Canada must conform to the local codes or in the absence of local codes to the current version of Natural Gas and Propane Installation Code, CSA B149. Electrical installations must conform to the local codes or, in the absence of local codes, to the current version of Canadian Electrical Code, CSA C22.1.1
- Installations in the USA must conform to the local codes or in the absence of local codes to the current version of National Fuel Gas Code, ANSI Z223.1/NFPA 54. Electrical installations must conform to the local codes or, in the absence of local codes, to the current version of the National Electrical Code, ANSI/NFPA 70. See Appendix C for installation within the State of Massachusetts

NOTICE

Clothing or other flammable material should not be placed on or near the appliance

NOTICE

Installation and repair should be done by a qualified service person. The appliance should be inspected before use and at least annually by a professional service person. More frequent cleaning might be required due to excessive lint from carpeting, bedding material, etc. It is imperative that control compartments, burners, and circulating air passageways of the appliance be kept clean

Standard Installation Checklist

This standard installation checklist is to be used by the installer in conjunction with, not instead of, the instructions contained within this installation manual.



Customer _____	Date Installed: _____
Install Address: _____	Location of Fireplace: _____
_____	Installer: _____
Model (circle one): D6315 DL6315 DL6315ST D6315ST	Dealer Phone: _____
	Serial #: _____

	YES	NO	IF NO, WHY NOT?
Appliance Install: Section 2			
Framing complies with install manual.			
Standoffs have been installed.			
Proper clearances have been maintained.			
Venting: Section 3			
Venting configuration complies with vent diagrams.			
Venting installed, fastened, and secured in place maintaining proper clearance.			
Firestops installed.			
Exterior wall/roof flashing installed and sealed in compliance with local building code.			
Terminations installed and sealed in compliance with local building code.			
Direct vent termination is highest point in vent assembly.			
Wiring/Electrical: Section 4			
Unswitched power provided to the appliance PPO box.			
Low voltage wire connected to dry contact wall switch (non-powered)*			
Gas: Section 5			
Proper appliance for fuel type.			
Was a conversion performed?			
Leak check performed & inlet pressure verified.			
Finishing: Section 6			
Only non-combustible materials installed in non-combustible areas.			
Clearances meet installation manual requirements			
Mantels and/or projections comply with install manual			
Appliance Setup: Section 7 through 9			
Media, door, and screen installed according to install manual			
Manual given to home owner.			
Started appliance and verified no gas leaks exist.			
Comments:			

*Only applicable for DL Series

Rating Plate Sample

Do Not Remove This Label
N'enlevez Pas Cette Étiquette

Type: **Vented Gas Fireplace Heater** **For Indoor Use Only**

Not for use with solid fuel. / Pas pour l'usage avec le combustible solide.
Not for use with air filters. / Pas pour l'usage avec des filtres à air.

Model No. Modèle: D6315N-2

Serial No.: 2-170329-XXXXXX

Manufacturer / Fabricant: Canadian Heating Products Inc., Langley BC, (www.montigo.com)
Montigo DelRay Corp., Ferndale, WA, (www.montigo.com)

Tested To / Examiné À: **CSA/ANSI Z21.88-2019 / CSA2.33-2019**

Electrical Rating / Estimation Électrique: 115V / 1Ph / 60Hz / less than 12A
Altitude Rating / Estimation D'Altitude: N & H (0 - 4500 ft. / 0 - 1371 m.)

Fuel Type / Type De Carburant:

<input checked="" type="checkbox"/> Natural Gas / Gaz Naturel	Max. Input BTU/H	Min. Input BTU/H	Output / Rendement BTU/H	Orifice Size / Taille D'Orifice Front/Avant Rear/Derrière	Gas Manifold Pressure / Pression D'Admission Du Gaz	Min. Gas Supply Pressure/ Min. Pression D'Alimentation Du Gaz
<input type="checkbox"/> Propane / Gaz Propane	50,000	27,000	N/A	3.40 MM / N/A	3.8" W.C.	5.5" W.C.
				46 DMS / N/A	11" W.C.	13" W.C.

FOR USE WITH GLASS DOORS AND SCREENS CERTIFIED WITH THE APPLIANCE ONLY
Pour utilisation avec portes de verre and écrans de certifiés avec l'appareil seulement



***Refer to installation manual for more information.**
*Référez-vous au manuel d'installation pour plus d'information.

***Clearance to Combustibles**
***Degagements Aux Combustibles**

Sides/Côtés:	3.3"
Back/Derrière:	2"
Top-Top Vent/Du Haut-Évent Du Haut:	38.25"
Top-Rear Vent/Du Haut-Évent Arrière:	N/A
Floor/Plancher:	0"
Mantel/Manteau:	24"
Recess Depth/ Profondeur D'Encadrement:	N/A
Facing:	NC

Figure 1 Rating Plate for D6315

Do Not Remove This Label
N'enlevez Pas Cette Étiquette

Type: **Vented Gas Fireplace Heater** **For Indoor Use Only**

Not for use with solid fuel. / Pas pour l'usage avec le combustible solide.
Not for use with air filters. / Pas pour l'usage avec des filtres à air.

Model No. Modèle: DL6315N

Serial No.: 2-170329-XXXXXX

Manufacturer / Fabricant: Canadian Heating Products Inc., Langley BC, (www.montigo.com)
Montigo DelRay Corp., Ferndale, WA, (www.montigo.com)

Tested To / Examiné À: **CSA/ANSI Z21.88-2019 / CSA2.33-2019**

Electrical Rating / Estimation Électrique: 115V / 1Ph / 60Hz / less than 12A
Altitude Rating / Estimation D'Altitude: N & H (0 - 4500 ft. / 0 - 1371 m.)

Fuel Type / Type De Carburant:

<input checked="" type="checkbox"/> Natural Gas / Gaz Naturel	Max. Input BTU/H	Min. Input BTU/H	Output / Rendement BTU/H	Orifice Size / Taille D'Orifice Front/Avant Rear/Derrière	Gas Manifold Pressure / Pression D'Admission Du Gaz	Min. Gas Supply Pressure/ Min. Pression D'Alimentation Du Gaz
<input type="checkbox"/> Propane / Gaz Propane	40,000	40,000	N/A	3.10 MM / N/A	3.5" W.C.	5.5" W.C.
	40,000	40,000	N/A	49 DMS / N/A	10" W.C.	11" W.C.

FOR USE WITH GLASS DOORS AND SCREENS CERTIFIED WITH THE APPLIANCE ONLY
Pour utilisation avec portes de verre and écrans de certifiés avec l'appareil seulement

***Refer to installation manual for more information.**
*Référez-vous au manuel d'installation pour plus d'information.

***Clearance to Combustibles**
***Degagements Aux Combustibles**

Sides/Côtés:	3.3"
Back/Derrière:	2"
Top-Top Vent/Du Haut-Évent Du Haut:	38.25"
Top-Rear Vent/Du Haut-Évent Arrière:	N/A
Floor/Plancher:	0"
Mantel/Manteau:	24"
Recess Depth/ Profondeur D'Encadrement:	N/A
Facing:	NC

Figure 1.b Rating Plate for DL6315

Section 1: Product Dimensions

The fireplace dimensions are shown below:

SINGLE SIDED

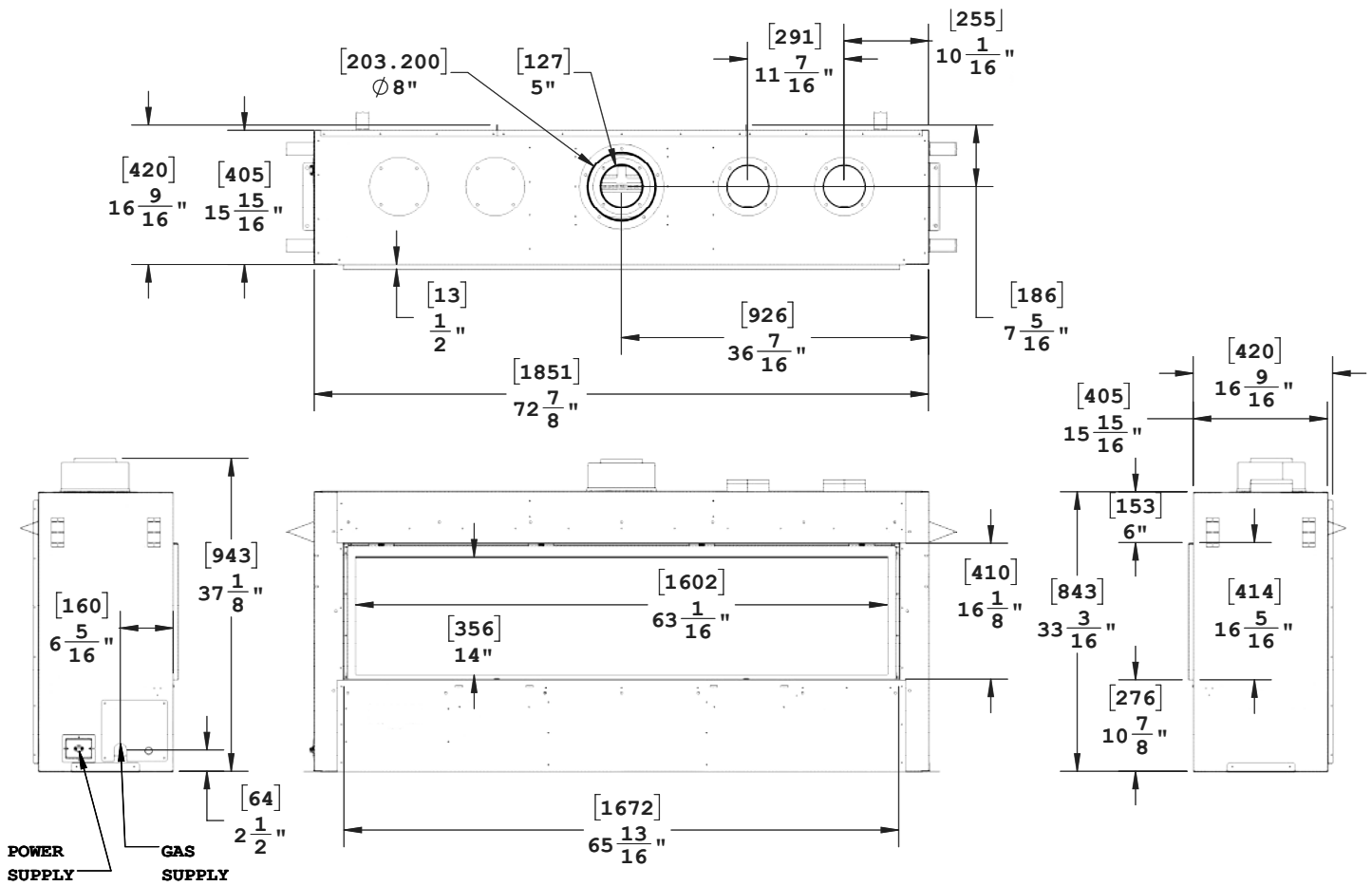

Figure 2. DL6315, D6315 Fireplace dimensions (Tolerance $\pm \frac{1}{8}$ ").

SEE-THRU

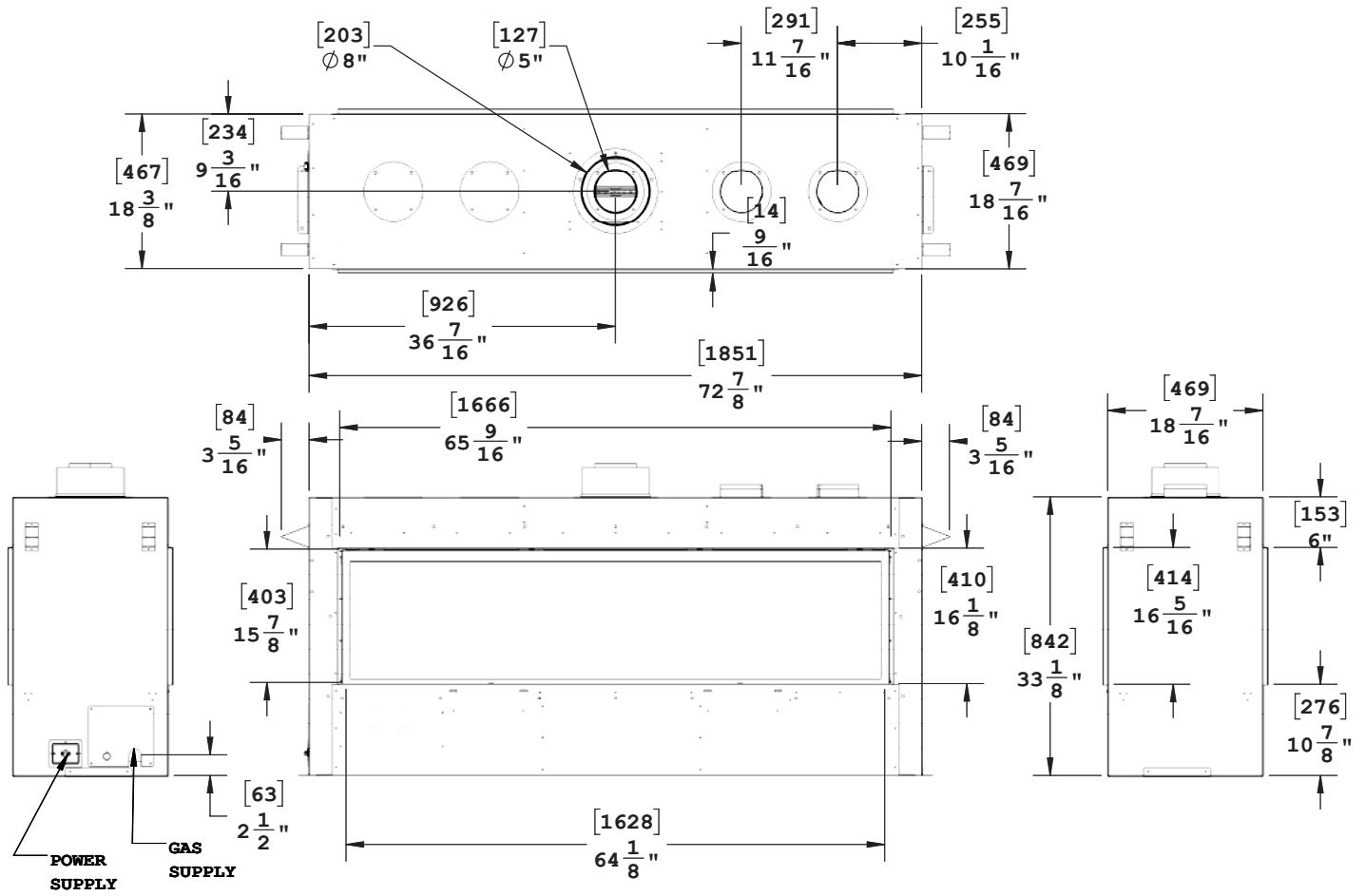

Figure 2.b DL6315ST, D6315ST Fireplace dimensions (Tolerance $\pm \frac{1}{16}''$).

Section 2: Framing

Combustible Wall Clearances

To ensure the fireplace operates safely, all models must maintain the following clearances:

MODEL	Top †	Sides	Floor	Back
D6315 DL6315	38 $\frac{7}{8}$ "	3 $\frac{1}{3}$ "	0"	2"
DL6315ST D6315ST	38 $\frac{7}{8}$ "	3 $\frac{1}{3}$ "	0"	N/A

Figure 3. Combustible Wall Clearances

† Note: Clearance from top of fireplace to a combustible ceiling within the fireplace enclosure.

Unprotected combustible walls which are perpendicular to the fireplace opening must maintain 6" clearance.

NOTE: When constructing the framed opening, please ensure there is access to install the gas line when the unit is installed.

Recommended flooring considerations

Flooring such as Luxury Vinyl Plank (LVP) and other vinyl flooring can be sensitive to radiant heat and changes in temperature. If using vinyl flooring we recommend you install the fireplace in one of the ways shown below.

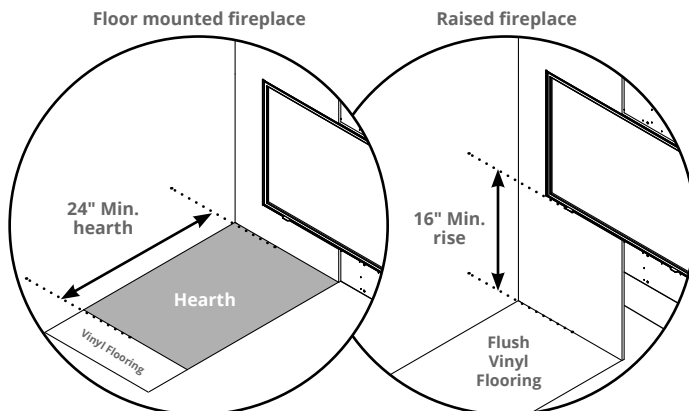

The minimum width of the hearth is equal to the width of the fireplace.

Raise the fireplace 16" above the floor to allow for vinyl flooring to be installed flush to the wall. (Measured from floor to the bottom of the door opening)

WARNING

When this appliance is installed directly on ANY combustible materials other than wood flooring (carpet, vinyl, etc), it must be installed on an equivalent wood or metal panel. This material must extend the full width and depth of the appliance.

Note: Images are shown without screens for clarity purposes. However, your fireplace should not be operated without proper installation of screens.

NOTICE

Clearances must be in accordance with local installation codes and the requirements of the gas supplier

Raised Installation Framing - Single Sided

Determine the height of the platform based on where you want the bottom edge of the glass to be, see below for unit dimensions. Maintain minimum ceiling height shown in table. Build fireplace frame as shown.

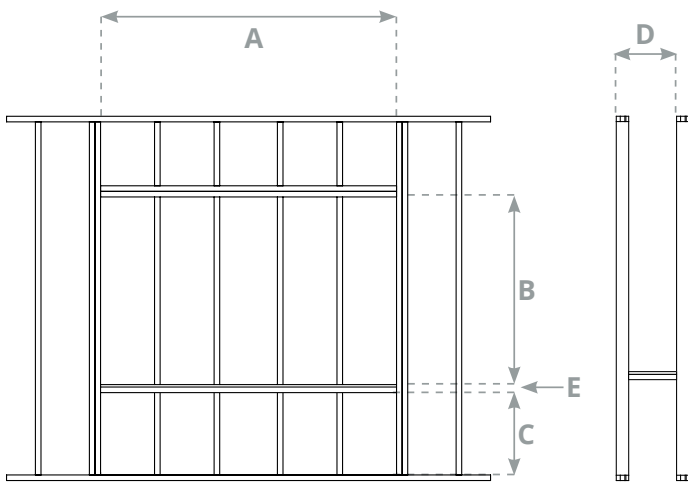

Figure 4. Raised Installation Framing - Single Sided

D6315, DL6315	
A	79 1/2"
B	50 3/8"
C	MAX 48"*
D	18"
E†	2 1/4"

*24" platform height requires a minimum of 8' ceiling height. The unit can be placed on a 48" platform if a minimum of 10' ceiling is attained.

†Measurement is a 2x4 on side and a 3/4" plywood platform.

Raised Installation Framing - See Through

Determine the height of the platform based on where you want the bottom edge of the glass to be, see below for unit dimensions. Maintain minimum ceiling height shown in table. Build fireplace frame as shown.

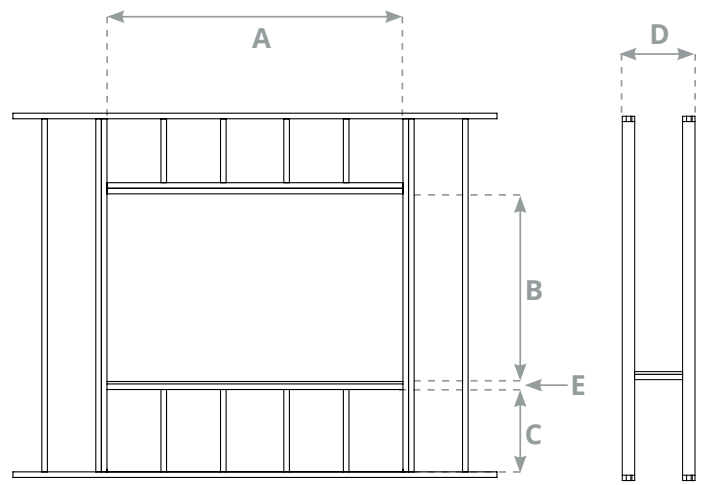

Figure 4.b Raised Installation Framing - See Through

D6315ST, DL6315ST	
A	79 1/2"
B	50 3/8"
C	MAX 48"*
D	18 7/16"
E†	2 1/4"

*24" platform height requires a minimum of 8' ceiling height. The unit can be placed on a 48" platform if a minimum of 10' ceiling is attained.

†Measurement is a 2x4 on side and a 3/4" plywood platform.

Framing the Single Sided Fireplace (Floor Installation)

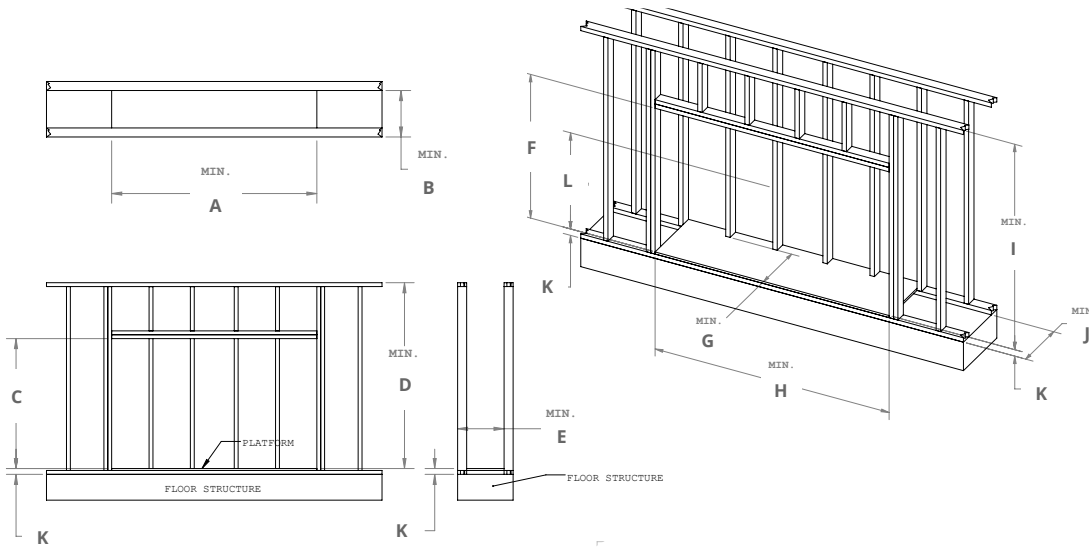

Figure 5. framing the Single Sided Fireplace

D6315	
A	79 1/2"
B	18"
C	50 3/8"
D	72"
E	18"
F	50 3/8"
G	18"
H	79 1/2"
I	72"
J	18"
K†	2 1/4"
L	33 11/16"

†Measurement is a 2x4 on side and a 3/4" plywood platform.

Framing the See-Through Fireplace (Floor Installation)

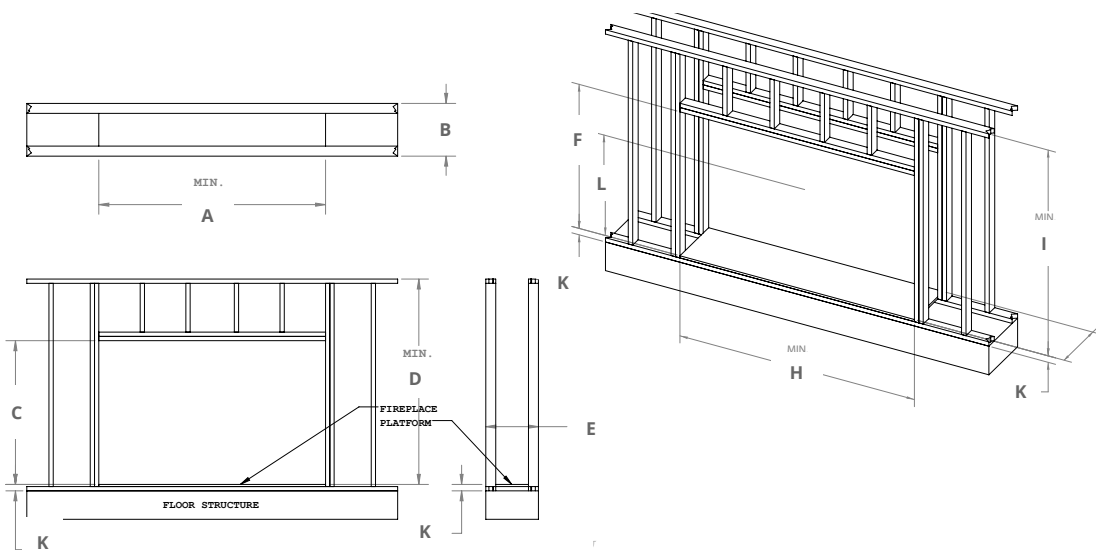

Figure 5.b framing the See-Through Fireplace

D6315ST	
A	79 1/2"
B	18 7/16"
C	50 3/8"
D	72"
E	18 7/16"
F	50 3/8"
G	N/A
H	79 1/2"
I	72"
J	18 7/16"
K†	2 1/4"
L	33 11/16"

†Measurement is a 2x4 on side and a 3/4" plywood platform.

Installing the Single Sided Fireplace

Place the Fireplace on the platform and install the Vent pipe. Next, connect the Gas line, and provide a gas service shut-off valve; according to local gas codes. Before fastening in place line up the front face of the fireplace. Then secure in place with 1/4" lag bolts to the platform.

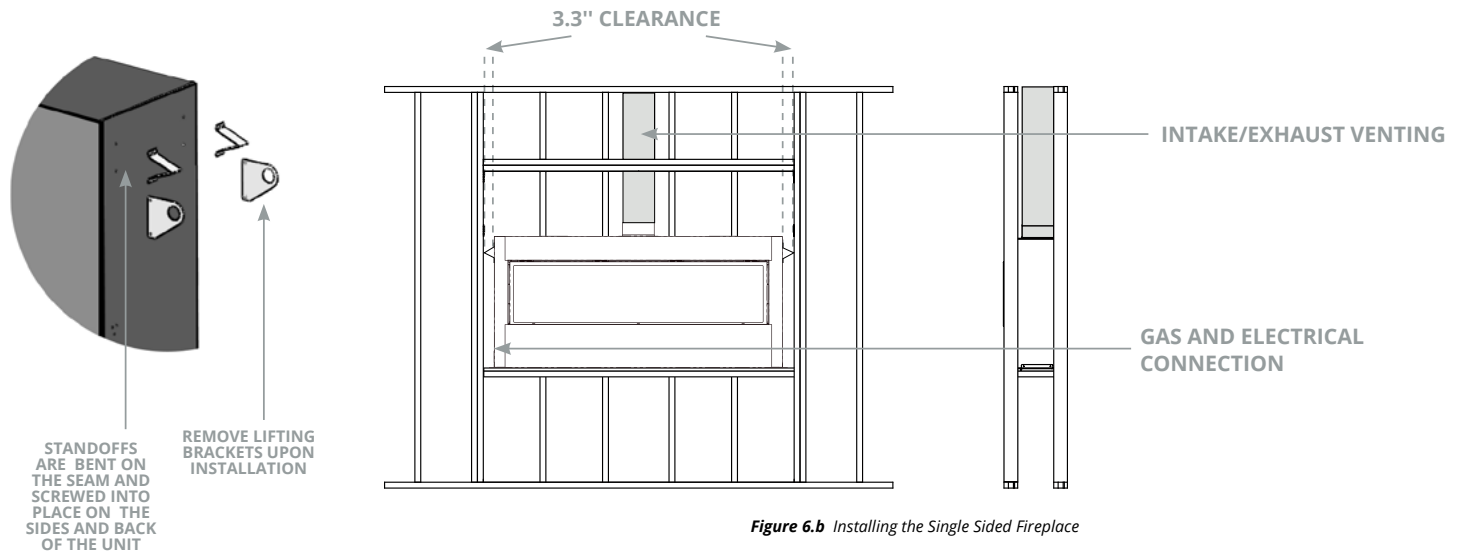

Figure 6. Standoff Installation

Installing the See Through Fireplace

Place the Fireplace on the platform and install the Vent pipe. Next, connect the Gas line, and provide a gas service shut-off valve; according to local gas codes. Before fastening in place line up the front face of the fireplace. Then secure in place with 1/4" lag bolts to the platform.

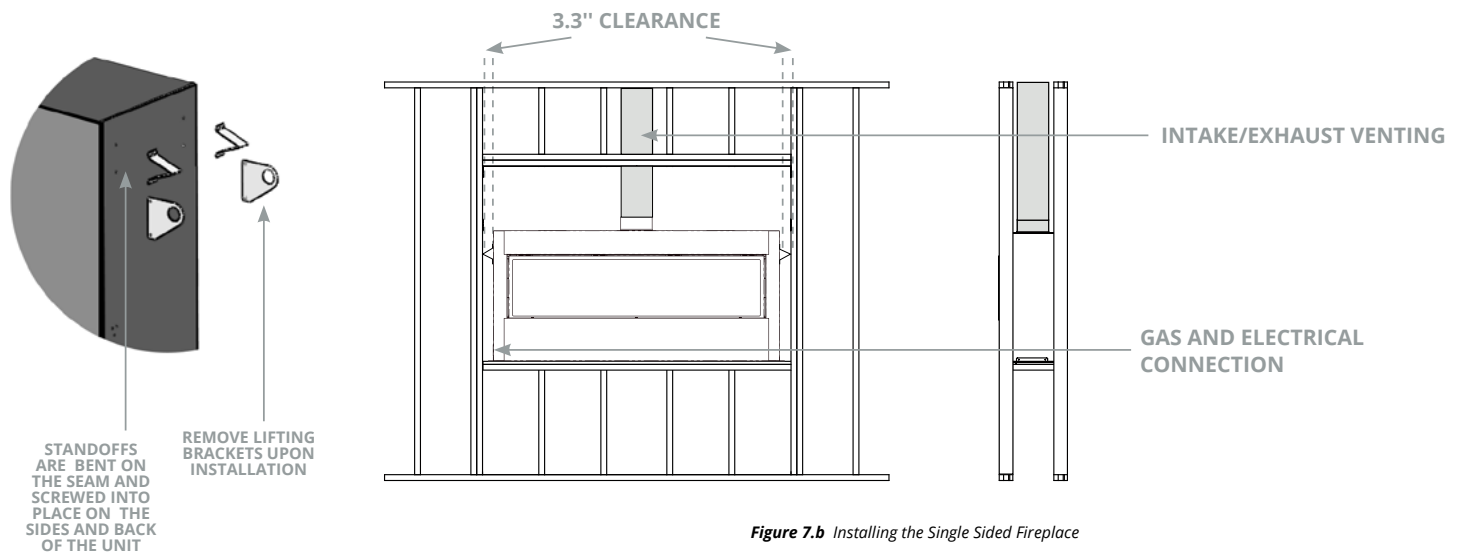

Figure 7. Standoff Installation

Assemble Non Combustible Framing D/DL6315/ST (Detail)

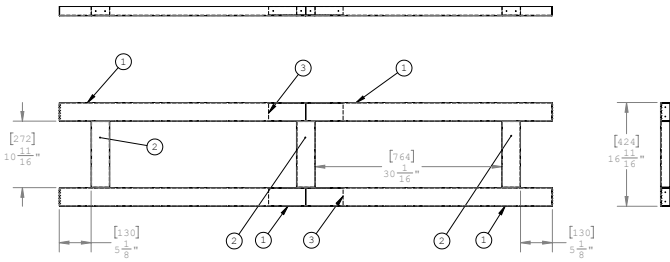
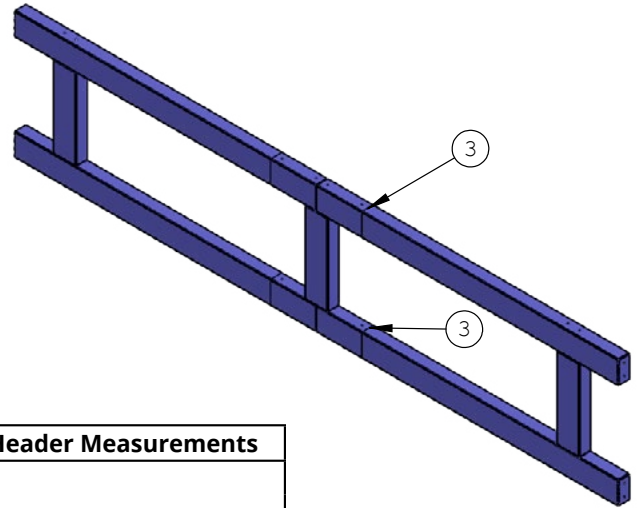

Figure 8. Assembly of Non Combustible Framing



Model	Supplied Steel Header Parts	Installed Steel Header Measurements
D/DL6315	Non-Combustible stud, Horizontal QTY.4	16 $\frac{11}{16}$ " x 79 $\frac{1}{2}$ "
	Non-Combustible stud, Vertical QTY.3	
	Non-Combustible Stud Connector QTY.2	
DL6315ST	Non-Combustible stud, Horizontal QTY.8	16 $\frac{11}{16}$ " x 79 $\frac{1}{2}$ "
	Non-Combustible stud, Vertical QTY.6	
	Non-Combustible Stud Connector QTY.4	

Assemble the frame using 1/4" self tapping screws (supplied)

Framing Box Assembly Single Sided

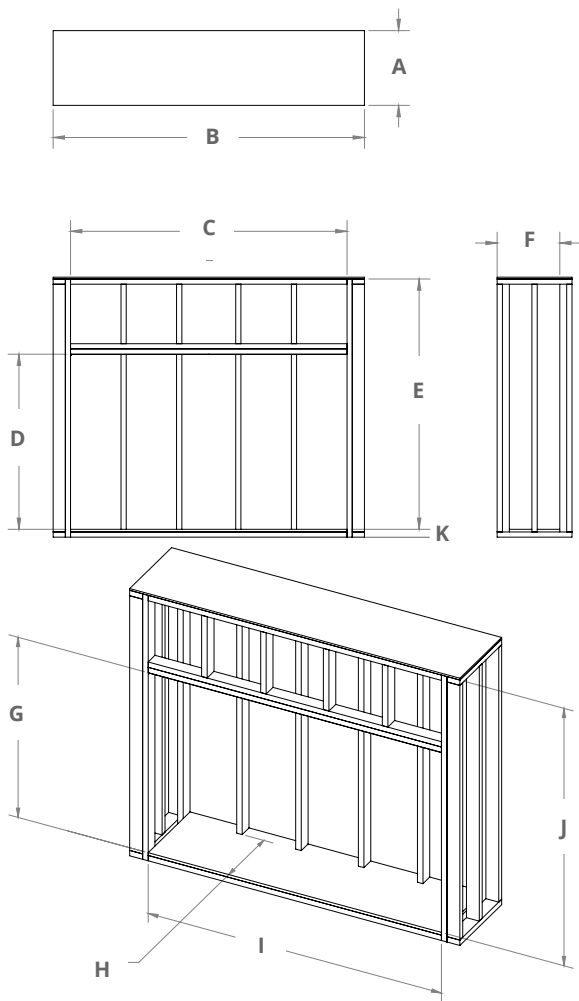

Figure 8. Framing Box Assembly Single Sided

D6315	
A	21 1/2"
B	89 1/2"
C	79 1/2"
D	50 3/8"
E	72"
F	18"
G	50 3/8"
H	18"
I	79 1/2"
J	72"
K†	2 1/4"

†Measurement is a 2x4 on side and a 3/4" plywood platform.

Framing Box Assembly See-Through

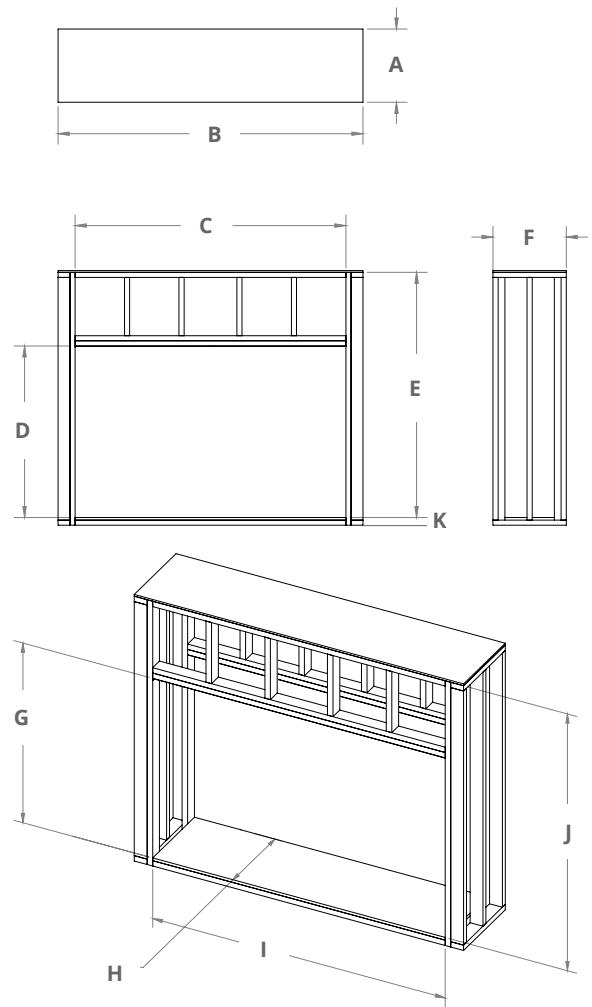

Figure 8.b Framing Box Assembly See-Through

D6315ST	
A	18 7/16"
B	89 1/2"
C	79 1/2"
D	50 3/8"
E	72"
F	18 7/16"
G	50 3/8"
H	18 7/16"
I	79 1/2"
J	72"
K†	2 1/4"

†Measurement is a 2x4 on side and a 3/4" plywood platform.

Framing with Cool Wall Advantage

Below are basic instructions on the framing of the Cool Wall advantage kit. More detailed instructions including the installation diagrams are included with the kit.

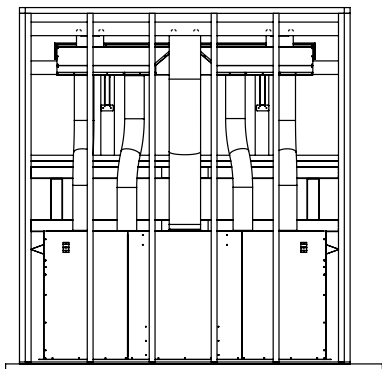
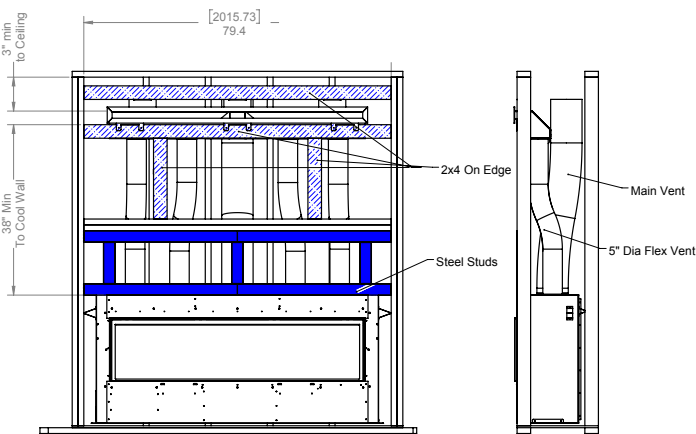

Figure 8.b.b Framing with Cool Wall Advantage

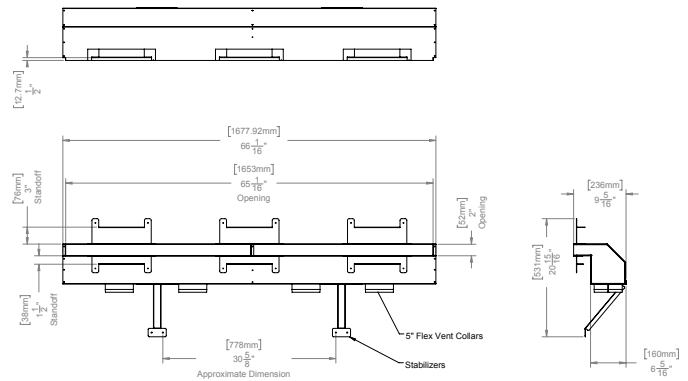

Figure 8.b.c Cool Wall Advantage vent dimensions

TV recess framing

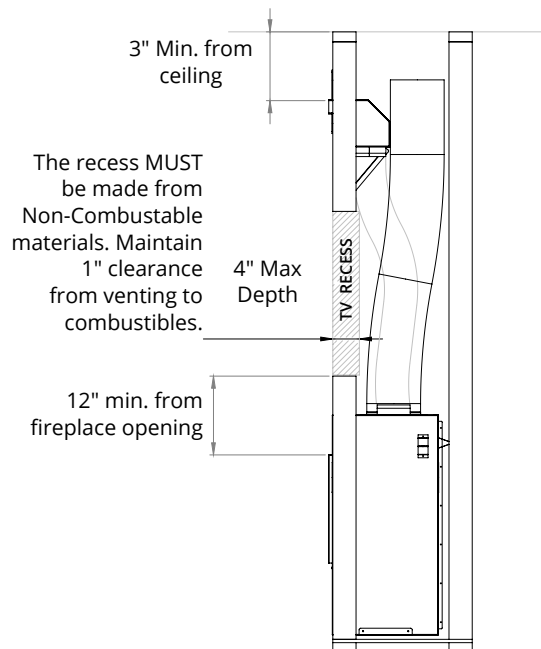

Figure 8.b.d Cool Wall Advantage TV recess dimensions

The recess must be made from Non-Combustable materials. Recess can be increased beyond a 4" depth by using a 45° or 90° elbow in venting after the minimum 3' upward distance is achieved, 1" clearance from venting to combustibles must still be maintained.

Section 3: Venting

The termination location MUST be selected such that it is the highest point in the venting assembly. It should also be selected such that it provides the shortest vent run possible. Should it be impossible to ensure that the termination is the highest point or should it be impossible to meet the venting guidelines laid out below please contact your Montigo dealer to discuss power venting options.

Notes For Planning Venting:

- Venting originates from the top of the unit.
- Venting can terminate through the roof or exterior wall.
- For a detailed diagram of allowed termination locations, see Appendix A.
- Once the termination location has been established refer to the appropriate section for installation details.
- For Heat Shield requirements see Section 3-3-3.

NOTICE

Under no circumstances can Montigo flex venting be cut to accommodate an installation. Use an alternative length to complete your vent run.

Restrictor plate Installation

The distinction is supplied with 3 different sized restrictor plates to improve flame efficiency. The size of restrictor used largely depends on the number of elbows used in the vent run, as well as vertical rise.



Figure 8.b.b Included Restrictor plates

Included Restrictor plates:

- 1" Baffle
- 1.5" Baffle
- 1.75" Baffle

Lengthy vertical runs without elbows would generally require the 1.75" restrictor. Shorter runs, or multi elbow installations would use the 1.5" or the 1" restrictor.



Figure 8.b.c Restrictor plate Installation

Install Restrictor plate over the vent opening from inside the firebox with two tek screws (supplied) into the firebox ceiling.

Section 3-3-1: Venting Layouts

Vertical Termination

*Restrictor may be required

D6315, D6315ST, DL6315, DL6315ST	
Vertical Minimum	Vertical Maximum
3 FT	32 FT

If the vent rise is over 8ft straight vertical, a restrictor must be installed. We recommend using the 1.75" wide restrictor. If 1.75" is too restrictive, a 1.5" and 1" restrictor is also supplied.

NOTE: If using a restrictor, use an IR gun to measure the glass temperature after 1 hour of running, and ensure the glass temperature does not exceed 470°F and ensure that none of the media and no part of the door has discoloured.

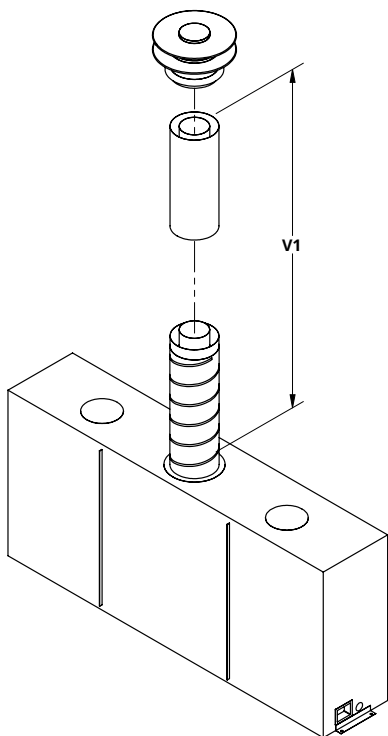

Figure 8. Vertical Termination

Vertical Termination - 2 Elbows

*Minimum 24" from top of unit before attaching an elbow

D6315, DL6315	
Vertical Minimum V1+V2	Horizontal Maximum H1
2 FT	1 FT
3 FT	4 FT
4 FT	7.5 FT
5 FT	11 FT
6 FT	14 FT
7 FT	17.5 FT
8 FT	21 FT

D6315ST, DL6315ST	
Vertical Minimum V1+V2	Horizontal Maximum H1
2 FT	3 FT
3 FT	6 FT
4 FT	9 FT
5 FT	12 FT
6 FT	15 FT
7 FT	18 FT
8 FT	21 FT

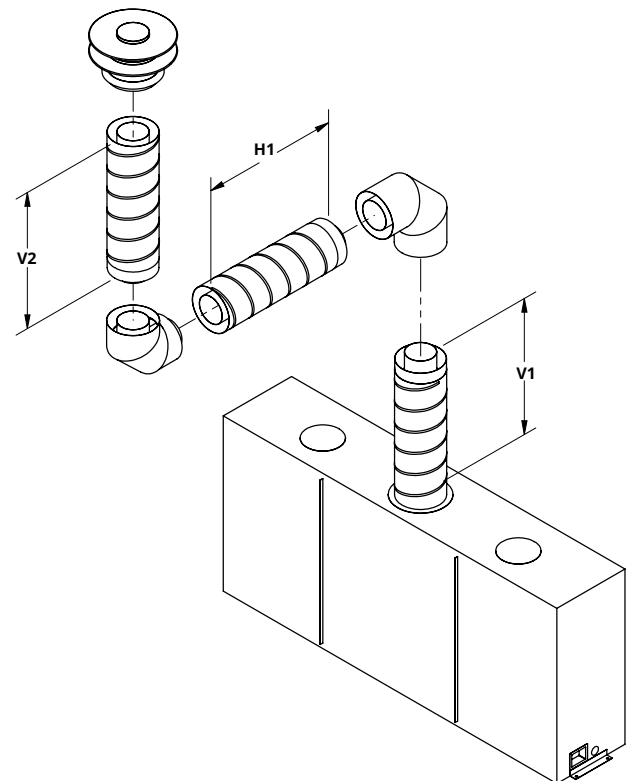

Figure 8.b Vertical Termination - 2 Elbows

Vertical Termination - 3 Elbows

*Minimum 24" from top of unit before attaching an elbow

D6315, DL6315	
Vertical Minimum V1+V2	Horizontal Maximum H1+H2
2 FT	1 FT
3 FT	4 FT
4 FT	7.5 FT
5 FT	11 FT
6 FT	14 FT
7 FT	17.5 FT
8 FT	21 FT

D6315ST, DL6315ST	
Vertical Minimum V1+V2	Horizontal Maximum H1+H2
2 FT	3 FT
3 FT	6 FT
4 FT	9 FT
5 FT	12 FT
6 FT	15 FT
7 FT	18 FT
8 FT	21 FT

Horizontal Termination - 1 Elbow

*Minimum 24" from top of unit before attaching an elbow

D6315, DL6315	
Vertical Minimum V1	Horizontal Maximum H1
2 FT	1 FT
3 FT	4 FT
4 FT	7.5 FT
5 FT	11 FT
6 FT	14 FT
7 FT	17.5 FT
8 FT	21 FT

D6315ST, DL6315ST	
Vertical Minimum V1	Horizontal Maximum H1
2 FT	3 FT
3 FT	6 FT
4 FT	9 FT
5 FT	12 FT
6 FT	15 FT
7 FT	18 FT
8 FT	21 FT

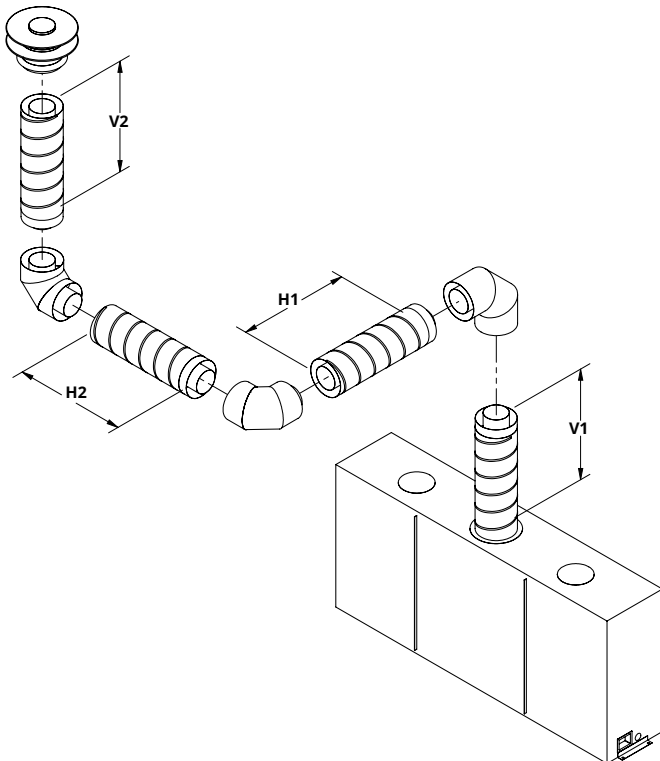

Figure 8.c Vertical Termination - 3 Elbows

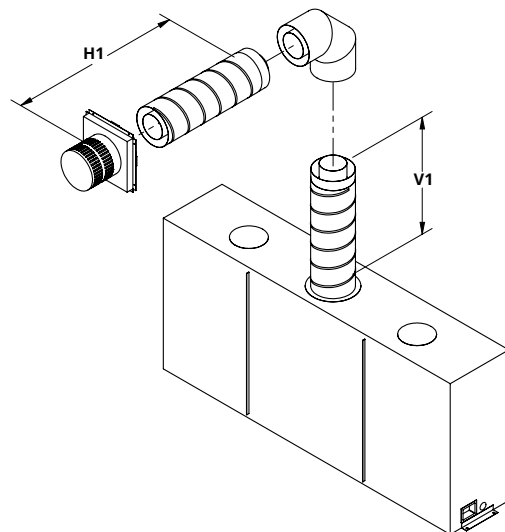

Figure 8.d Horizontal Termination - 1 Elbow

Horizontal Termination - 2 Elbows

*Minimum 24" from top of unit before attaching an elbow

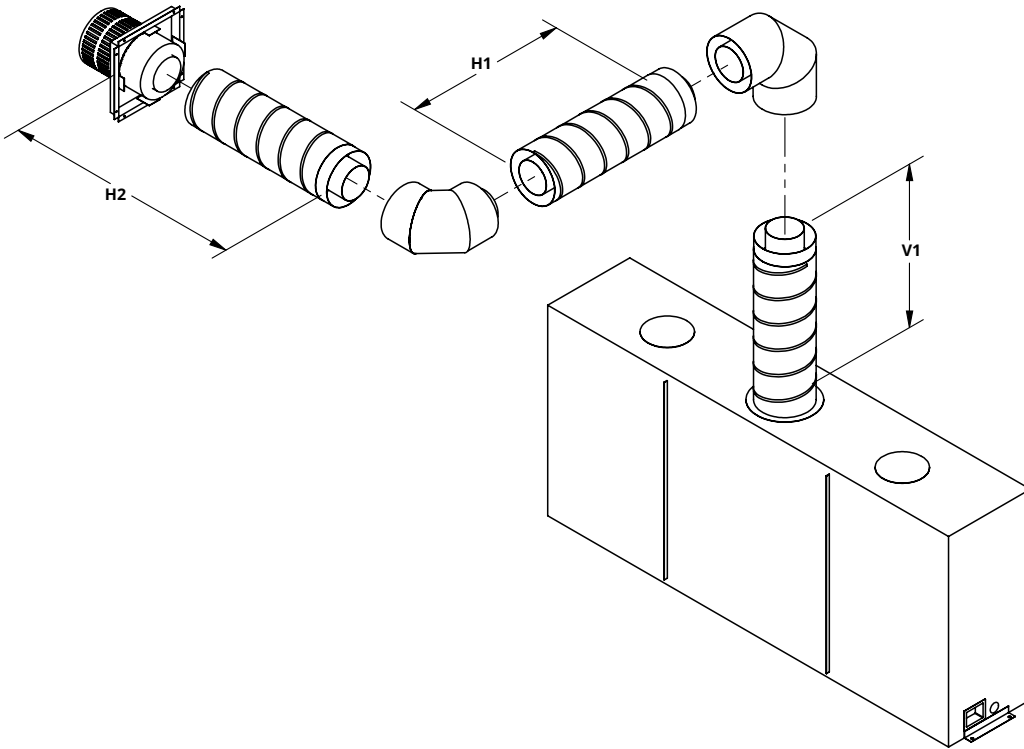

Figure 8.e Horizontal Termination - 2 Elbows

D6315, DL6315	
Vertical Minimum V1	Horizontal Maximum H1+H2
2 FT	1 FT
3 FT	4 FT
4 FT	7.5 FT
5 FT	11 FT
6 FT	14 FT
7 FT	17.5 FT
8 FT	21 FT

D6315ST, DL6315ST	
Vertical Minimum V1	Horizontal Maximum H1+H2
2 FT	3 FT
3 FT	6 FT
4 FT	9 FT
5 FT	12 FT
6 FT	15 FT
7 FT	18 FT
8 FT	21 FT

Horizontal Termination - 3 Elbows

*Minimum 24" from top of unit before attaching an elbow

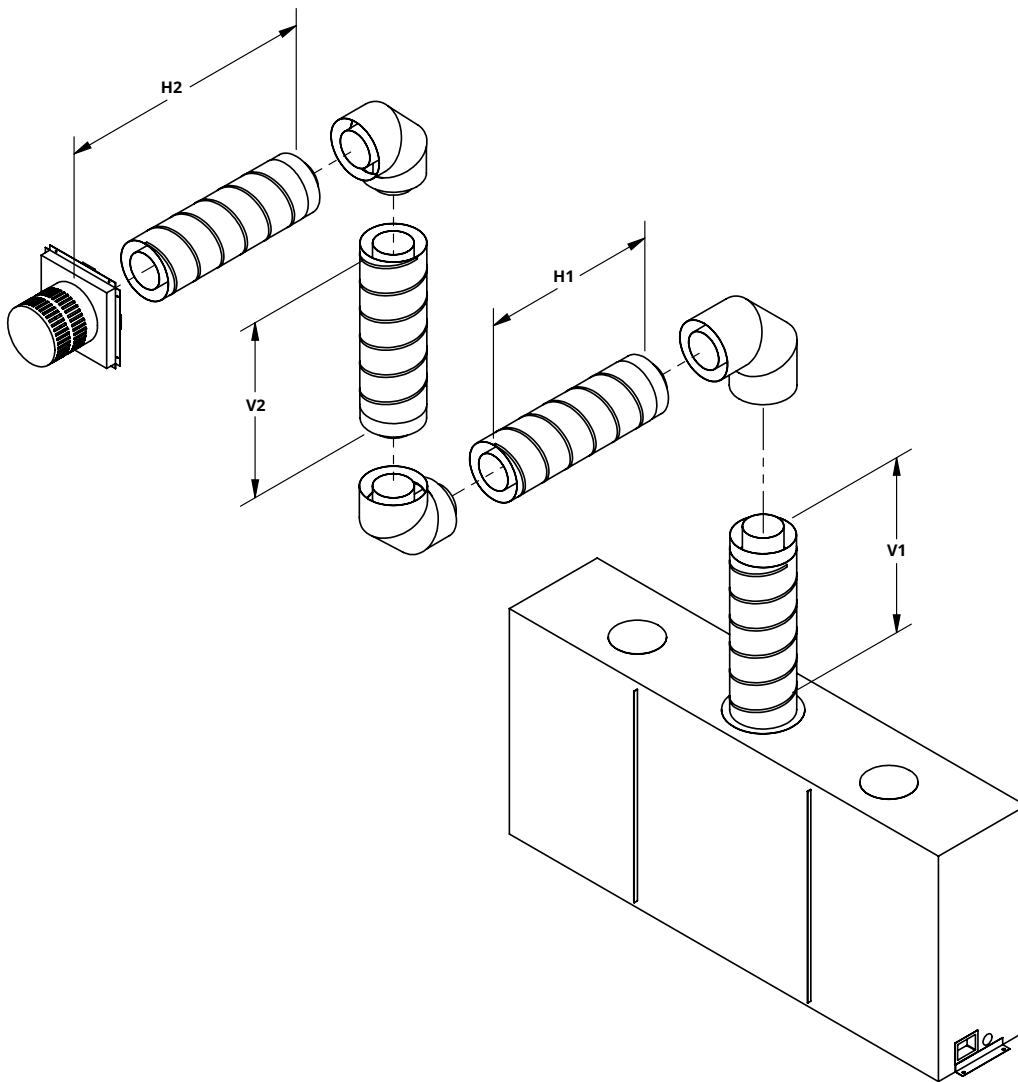

Figure 8.f Horizontal Termination - 3 Elbows

D6315, DL6315	
Vertical Minimum V1+V2	Horizontal Maximum H1+H2
2 FT	1 FT
3 FT	4 FT
4 FT	7.5 FT
5 FT	11 FT
6 FT	14 FT
7 FT	17.5 FT
8 FT	21 FT

D6315ST, DL6315ST	
Vertical Minimum V1+V2	Horizontal Maximum H1+H2
2 FT	3 FT
3 FT	6 FT
4 FT	9 FT
5 FT	12 FT
6 FT	15 FT
7 FT	18 FT
8 FT	21 FT

Section 3-2: Installing a Roof Mounted Direct Vent Termination (PVTk1SS)

This section applies to installations where the direct vent termination will be roof mounted.

Section 3-2-1: Venting Layout

Selection of components and details of venting lay out should adhere to the following guidelines:

- The maximum termination point is 32' above the fireplace. (NOTE: if the maximum termination height is used, the flame pattern may be affected).
- The vertical termination must be a minimum 2' higher than where the termination exits the roofing materials, (asphalt shingles, cedar shakes, etc). This distance should be measured from the high side of the roof slope where the flue flashing intersects the roofing materials.
- For a detailed diagram of allowed termination locations, see Appendix A.
- Termination location must be a minimum 6' from a mechanical air inlet.
- A maximum of three offsets (each offset is made up of 2-90° bends) may be made for vertical vent runs.
- Firestops must be installed as required by National & local codes.
- Ensure all horizontal runs are supported with a minimum of 3 supports per 10' of venting.
- Install all roof flashing and storm collars as shown.

Roof mounted Terminations

The following details are some possible configurations for Roof mounted terminations. See below.

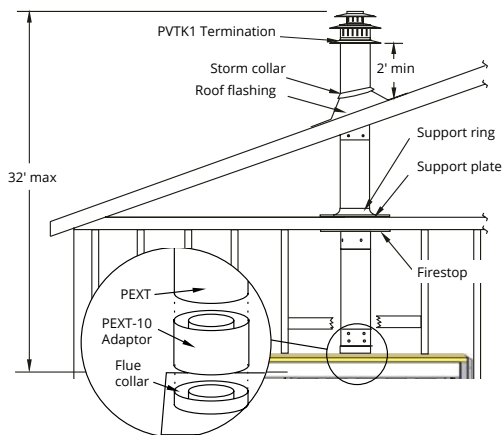

Figure 9. Top vent, Roof mounted termination with no offset in vent run.

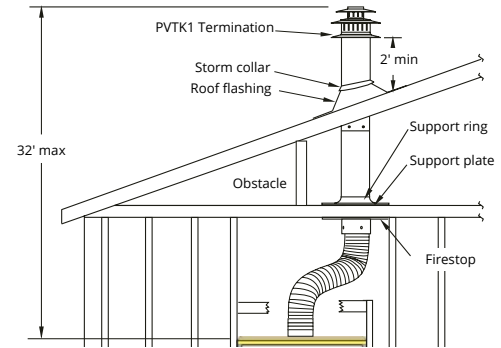

Figure 9.b Top vent, Roof mounted with 1 offset (1 offset= two 90° bends).

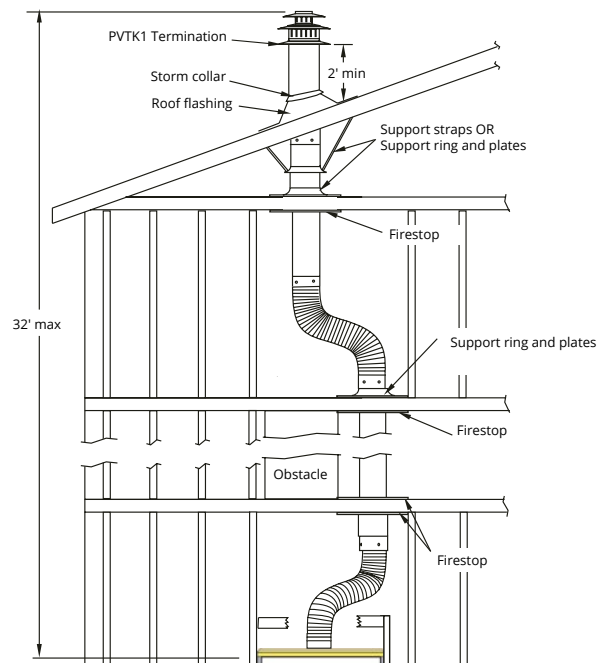

Figure 9.c Top vent, Roof mounted with 2 offsets (1 offset= two 90° bends).

Section 3-3: Installing a Wall Mounted Direct Vent Termination

This section applies to installations where the direct vent termination will be wall mounted.

Installation of termination with built in frame

A Termination with a Built-In Frame is installed during framing of a structure.

1. Frame the termination opening to 11" x 11".
2. Install exterior sheathing to the structure framing.
3. Fasten the termination to the sheathing using a minimum of 4 screws.

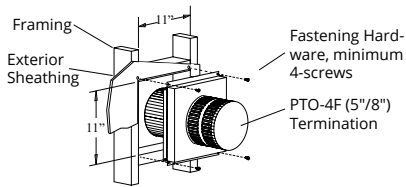

Figure 10. Installing a PTO-4F termination.

Installation of termination frame at time of framing

Terminations with a MSR frame allow the installation of the frame prior to installation of the termination.

1. Frame the termination opening to 12" x 12".
2. Secure the MSR Frame to the exterior sheathing of the structure.
3. Fasten the termination to the MSR Frame using a minimum of 4 screws.

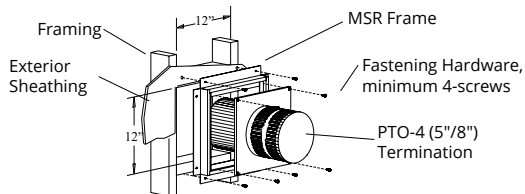

Figure 10.b Installing a PTO termination with the MSR frame.

Installation of termination frame at time of framing in masonry

Terminations with a BSR frame allow the installation of the frame in masonry prior to the installation of the termination

1. Frame the BSR opening to 12" x 12".
2. Secure the BSR Frame to the exterior sheathing of the structure.
3. Fasten the termination to the BSR Frame using a minimum of 4 screws.

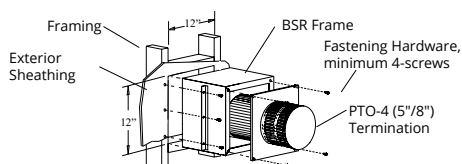

Figure 10.c Installing a PTO termination with the BSR frame.

Installation of termination from inside structure

A Termination with a MOSR Frame is installed from the inside of the structure. These are commonly used in high-rise construction.

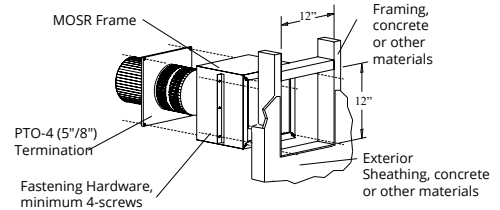

Figure 10.d Installing a PTO termination with MOSR frame.

1. Frame the MOSR opening to 12" x 12".
2. Fasten the MOSR frame to the interior side of the studs, concrete, or finished wall construction using a minimum of 4 screws.
3. Insert the termination into the MOSR frame as shown here, (from the inside) and attach to the MOSR by installing a min. quantity of 4 bolts into the threaded nuts on the MOSR Frame.

Installation of a termination shield for vinyl siding

The VSS Termination shield is installed when the exterior of a structure is clad with Vinyl siding. It is placed directly above, and on-center with the termination.

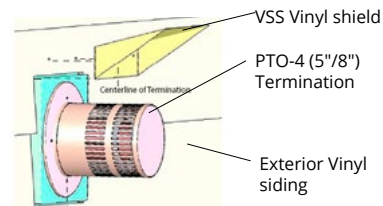

Figure 10.e Installing the VSS Vinyl Shield.

Installing heat guards

Installing heat guards over terminations is recommended in installations where the termination is located within 7' feet above grade, or above a pedestrian walkway, and may be required by code in public areas.

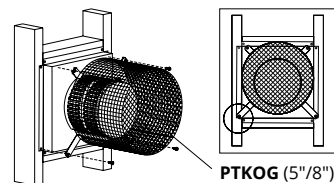

Figure 10.f Installing a PTO termination heat guard.

1. Ensure that the two long mounting brackets are facing the bottom of the termination (See inset). This will provide more heat protection at the top of the termination, where temperatures are highest.
2. Attach to the faceplate of the termination using four sheet metal screws.

Section 3-3-2: Venting Components

The following components and associated Montigo part numbers for installation of a roof or wall mounted termination. Use of non-Montigo approved parts will VOID the warranty and may impede operation of the fireplace.

A - Termination	PTO4 (3" Length) PTO4F (3" Length) PVTK1SS
B - Frame Kits	MSR (Stucco Frame) MOSR (Stucco Frame) BSR-4 (4" Brick Frame) BSR-6 (6" Brick Frame)
C - Flex Sections	PFL - 1 (12" f/f Section) PFL - 18 (18" f/f Section) PFL - 2 (24" f/f Section) PFL - 3 (36" f/f Section) PFL - 4 (48" f/f Section) PFL - 6 (72" f/f Section)
D - Rigid Pipe	PEXT - 1 (12" f/m Section) PEXT - 2 (24" f/m Section) PEXT - 3 (36" f/m Section) PEXT - 4 (48" f/m Section) PEXT - 6 (72" f/m Section)
E - Rigid Pipe Extension	PXT - 5 (5" f/f Section) PXT - 12 (12" f/f Section) PXT - 20 (20" f/f Section)
F - Elbows	PEL-90MM (m/m 90° Elbow) PEL-90FF (f/f 90° Elbow) PEL-90FM (f/m 90° Elbow) PEL-45FM (f/m 45° Elbow)
G - Wall Penetration Kit	PFVK01F
H - Support Ring & Plate	PSPXT-8
I - Firestop	FS-8
J - Roof Flashing	PRF-7 (1/12 - 7/12 pt.) PRF-12 (7/12 - 12/12 pt.)
K - Heat Shield	RHS101
L - Heat Guard	MTKOG

Connection and installation of the vent components should adhere to the following guidelines:

- Use any combination of rigid and flex pipe as required and in any orientation (Male connectors can face in any direction).
- Flex sections may be stretched up to 50% of their total length (e.g. a 24" section may be stretched to 36").
- Connect all vent sections using a minimum of three sheet metal screws on the outer pipe flue.
- Ensure the pipe ends male to female slide in a minimum of 1 1/2" of overlap.
- Ensure all horizontal runs are supported with a minimum of 3 supports per 10' of venting.
- When hanging/supporting venting, ensure that 1" clearance is maintained on sides and bottom of vent runs and 2" above horizontal vent runs to any combustible material.
- Rigid pipe may be cut less than half way from the **FEMALE END ONLY**.
- Flex pipe cannot be cut
- Ensure when cutting sections of rigid pipe to maintain integrity of internal supports.
- For flex venting, place the springs supplied with the pipe kit, between the outer and inner pipes to keep the pipes separate and avoid any possible hot spots.
- Montigo recommends the use of a flex section for the final pipe connected directly to the fireplace offering greater flexibility of installation and absorption of movement.
- Firestops must be installed as required by National & local codes.

IMPORTANT:

Please Refer to your Building Envelope Engineer or Waterproofing Consultant for a review of ALL penetrations through exterior walls or the roof.

Section 3-3-2.2: Alternate Venting Components 5"/8"

Installation

The following components are approved for use with Montigo products. Please contact your local Montigo dealer for further information.

Component	Montigo P/N	DuraVent P/N	ICC P/N	MetalFab P/N	Selkirk P/N	Flexmaster P/N
NOTES		DuraVent adaptor is designed for collared vent components, DuraVent raw flex is true 5/8				
Termination	PTO4 (3" Length) PTO4F (3" Length) PVTK1SS (5/8 Vent)	58DVA-HC (Horiz. 5/8 vent) 58DVA-VCH (Vert.5/8 Vent)				
Rigid Sections (5/8 Vent)	PEXT - 1 (12" f/m) PEXT - 2 (24" f/m) PEXT - 3 (36" f/m) PEXT - 4 (48" f/m) PEXT - 6 (72" f/m)	58DVA-06 (6") 58DVA-09 (9") 58DVA-12 (12") 58DVA-18 (18") 58DVA-24 (24") 58DVA-36 (36") 58DVA-48 (48") 58DVA-60 (60")	5DL6 (6") 5DL9 (9") 5DL1 (12") 5DL2 (24") 5DL3 (36") 5DL4 (48")	5D6 (6") 5D12 (12") 5D18 (18") 5D24 (24") 5D36 (36") 5D48 (48")	5DT-06 5DT-09 5DT-12 5DT-18 5DT-24 5DT-36 5DT-48	5DVKIT58X01 5DVKIT58X01.5 5DVKIT58X02 5DVKIT58X03 5DVKIT58X04 5DVKIT58X06
Flex Sections (with collar)	PFL1 (12" flex pipe) PFL18 (18" flex pipe) PFL2 (24" flex pipe) PFL3 (36" flex pipe) PFL4 (48" flex pipe) PFL6 (72" flex pipe)	58DVA-36FF (36" F/F Section) 58DVA-60FF (60" F/F Section) 58DVA-120FF (120" F/F Section)				
Flex Sections (Raw, no collar) DuraVent adaptor 58DVA-AD-M1 not required when using raw flex		58DVA-36FO (36" Section) 58DVA-60FO (60" Section) 58DVA-120FO (120" Section)				4DVKIT58X01 4DVKIT58X01.5 4DVKIT58X02 4DVKIT58X03 4DVKIT58X04 4DVKIT58X06
Rigid Pipe Extension	PXT12 (12" f/f) PXT20 (20" f/f)	58DVA-08A (12") 58DVA-16A (20")	5DLT (12") 5DLS1 (12") 5DLT2 (20") 5DSL2 (20")	5DAL (3" to 10")	5DT-AJ12 (12")	
Rigid Telescopic Pipe		58DVA-17TA 58DVA-24TA	5DLA30			
Elbows (5/8 Vent)	PEL-90MM (m/m 90°) PEL-90FF (f/f 90°) PEL-90FM (f/m 90°) PEL-45FM (f/m 45°)	58DVA-E30 (30°) 58DVA-E45 (45°) 58DVA-E60 (60°) 58DVA-E90 (90°)	5DE45 (45°) 5DE90 (90°)	5D45L (45°) 5D90L (90°)	5DT-EL45 (45°) 5DT-EL90 (90°)	
Support Ring & Plate	PSPXT-8	58DVA-DC	5CS		5DT-CS	
Firestop	FS-8	58DVA-WFS 58DVA-FS	5CS	5DFS	5DT-FS	
Roof Flashing	PRF-7 (1/12 - 7/12 pt.) PRF-12 (7/12 - 12/12 pt.)	58DVA-FF (flat roof) 58DVA-F6 (0/12 - 6/12 pt.) 58DVA-F12 (7/12 - 12/12 pt.)		5DF (1/12 - 7/12 pt.) 5DF-12 (8/12 - 12/12 pt.)	5DT-AF6 5DT-AF12	
Metal/Tile Roof Flashing		58DVA-F6DS (0/12-6/12 pt.) 58DVA-F12DS (7/12-12/12 pt.)				
Heat Shield	RHS101	58DVA-WTU 58DVA-WT	5WT 5WTE		5DT-WT	2DVWTE58
Attic Radiation Shield		58DVA-IS	5AS 5RDS		5DT-AIS	
Vinyl Siding Heat Shield	VSS VSSSS	58DVA-VSK (Vinyl Siding Standoff)				
Wall Support		58DVA-WS	5WS	5DWS	5DTWSB	
Offset Support		58DVA-ES	5OS		5DT-OS	
Vaulted Ceiling Support		58DVA-CS	5SS	5DRS	5DT-CCS	
Storm Collar	SC8	58DVA-SC	5SC 5SQSC	5DSC	5DT-SC	
Montigo Fireplace Adapter		58DVA-AD-M1	TM-5AA6	5DNA		
Montigo Termination Adapter		58DVA-AD-M2	TM-5TA1	5DMTA		

Flexmaster as alternate venting

Flexmaster flex venting is approved on all Montigo residential fireplaces. Flexmaster Flex pipe may be used in any length as long as the respective vent graph provided in the manual is adhered to. This approval on Flexmaster Flex includes all and any prepackaged vent kits by Montigo containing Flexmaster venting. All Montigo prepackaged vent kits may be used on any Montigo residential unit fireplace. When using a Power vent you must use Montigo pipe only.

HORIZONTAL FLEX RUN REQUIREMENTS:

Follow venting graph for each model as required. Support horizontal sections every 2ft to prevent sagging, allow for a ¼" rise per foot of horizontal. Use high temperature silicone and three (3) screws at fireplace collar and termination collars. Reduce horizontal run by 36" for each 90° offset after the first one.

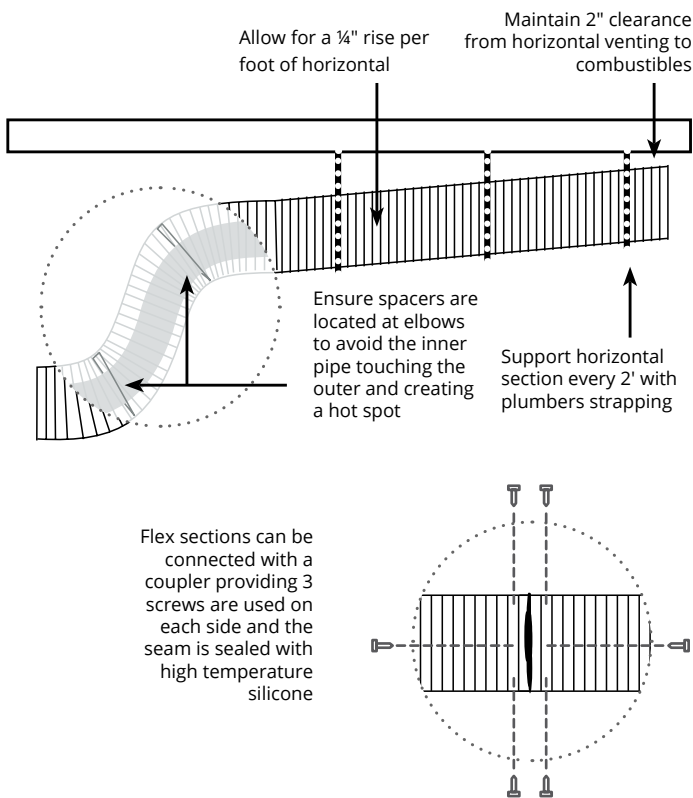

VERTICAL THROUGH THE ROOF:

Follow venting graph for each model as required. Use mil pack and three (3) screws at joints, support horizontal section every 2 ft, use one half of RHS100 as a firestop when passing through floors and ceilings, use additional firestops as necessary to keep construction debris and insulation away from contact with vent.

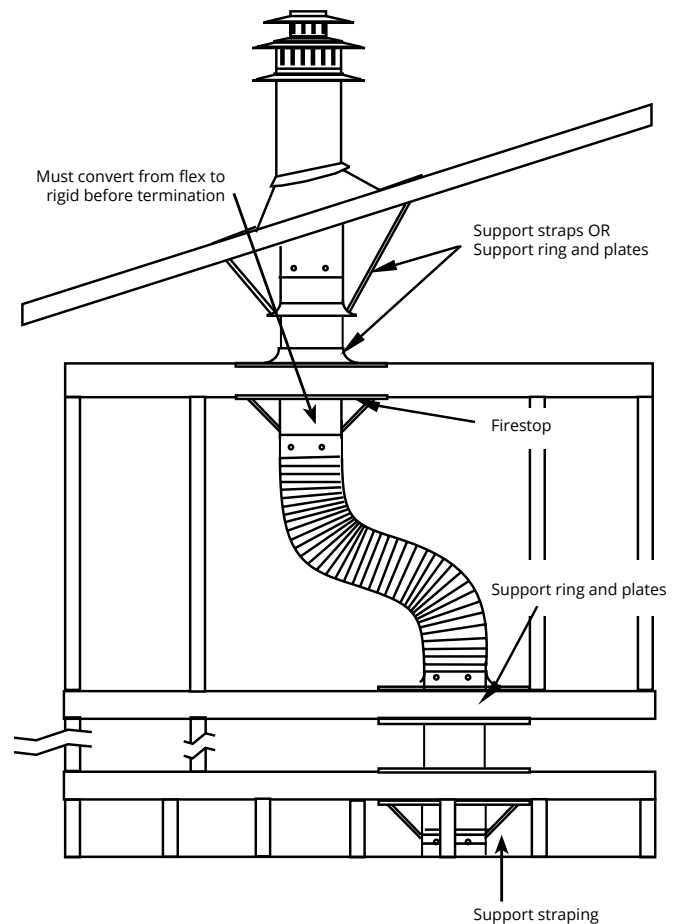

Section 3-5: Heat Shields

Installing a Wall Mounted Heat shield

The RHS10* Heat shield must be used if vent pipe passes through a wall or ceiling within 6' of the unit.

To install the Heat shield, Slide the Inner Section over the vent pipe that will connect to the fireplace. Then fasten the vent pipe to the back of the fireplace with a minimum of three sheet metal screws. From the outside slide the outer section on. To complete the installation fasten the Heat Shield Outer Section & inner section to the structure.

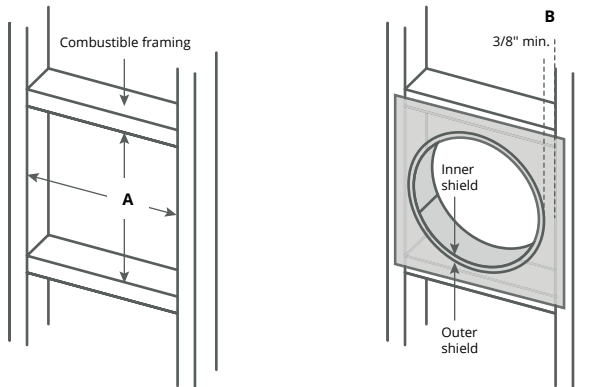

Figure 11. RHS10* Installation. (Install by sliding over vent pipe where it passes through the combustible construction).

Wall Mounted RHS* heat shield			
	Vent Size	A	B
RHS100	4/7	11"	3/8" min.
RHS101	5/8	11"	3/8" min.

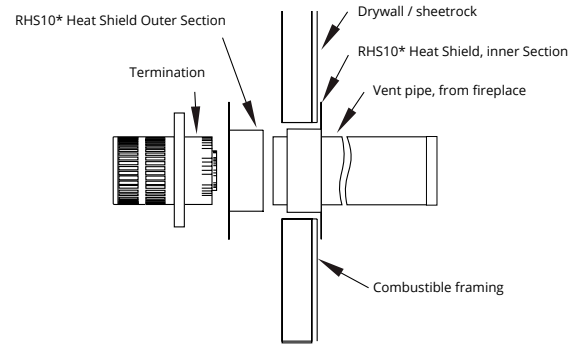

Figure 11.b RHS10* Installation. (Install by sliding Outer Section over vent pipe where it passes through the combustible construction).

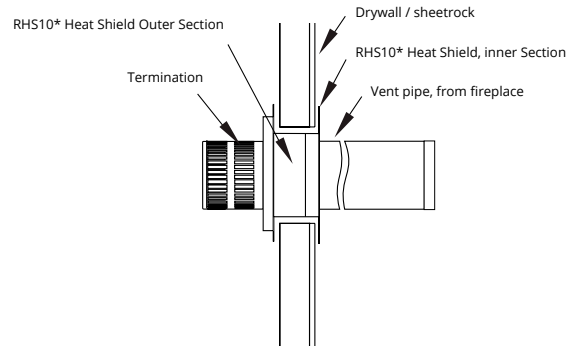

Figure 11.c Heat Shield. After sliding the outer section in place.

Burner tray Removal

Power and gas to the unit MUST be disconnected before installing

For instructions on how to remove the door please see the door install/removal section.

1. Remove the pilot cover from the burner tray.

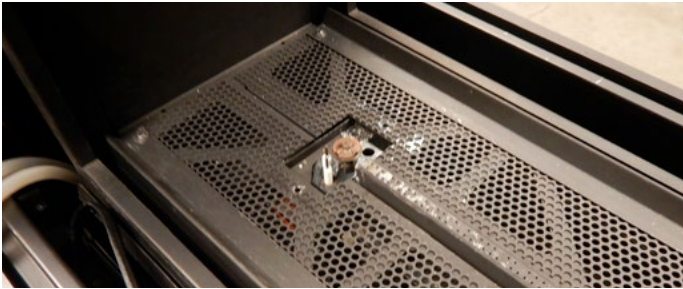

Figure 12. Removal of the pilot cover

2. Unscrew the 10 screws securing the media trays.

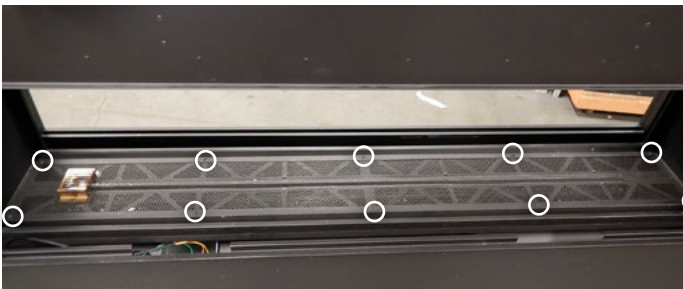

Figure 12.b Unscrewing the media trays

3. The trays can now be removed from the firebox.



Figure 12.c Removing the media trays

4. Loosen the 4 screws securing the burner strip to the stands.



Figure 12.d Removing the Burner screws

5. Carefully slide out burner strip from the firebox.



Figure 12.e Removing the Burner

6. Unscrew brackets securing metal plate to the bottom of the firebox.

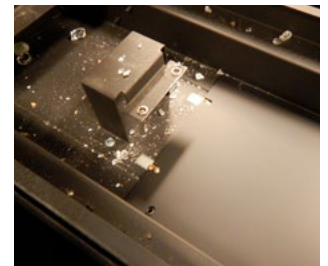

Figure 12.f Unscrewing brackets securing metal plate

7. Remove metal plate from bottom of the firebox.



Figure 12.g Removing metal plate

Propane Conversion

To convert the Distinction from Natural Gas to Propane, install the GCA008 conversion kit for DL units, and the GCA009 for D units. The unit must be disconnected from any gas supply, disconnected from any electrical supply and batteries and removed from any installation cavity.

Tools required

- 1). Torx T20 Screw Driver Bit
- 2). 3/8" Socket Driver
- 3). 5/32" Allen Key
- 4). Needle Nose Pliers or Small Flat Head Screw Driver

Parts included

- 1). Propane burner orifice
- 2). Propane pilot orifice
- 3). Propane valve control (with mounting screws)
- 4). Valve conversion label
- 5). Conversion plate label
- 6). Conversion technician identifying label

FOR NATURAL GAS BURNER REPLACEMENT, VENTURI SETTING IS 5/32.

For input rating, manifold pressure and orifice size, refer to sample rating plate on page 6

1. Shut off gas supply. Follow Burner tray removal instructions. Continue with the Propane Conversion instructions.

WARNING

This conversion kit shall be installed by a qualified gas fitter in accordance with the manufacturer's instructions and all applicable codes and requirements of the Authority Having Jurisdiction. If the information in these instructions is not followed exactly, a fire, explosion or production of carbon monoxide may result causing property damage, personal injury or loss of life. The qualified service agency is responsible for the proper installation of this kit. The installation is not proper and complete until the operation of the converted appliance is checked as specified in the manufacturer's instructions supplied with the kit.

CAUTION

The gas supply shall be shut off prior to disconnecting the electrical power, before proceeding with the conversion.

2. Loosen the 4 screws securing the burner strip to the stands.



Figure 13. Removal of burner strip

3. Loosen the a screw holding the venturi opening. Slide the venturi cover over so the opening is at the maximum width. Re-tighten screw.



Figure 13.b Loosening the venturi

4. Use 3/8" Socket Driver to loosen off the NG gas orifice, replace with Propane orifice as included in package. (46DMS for D6315STLI-2, 49DMS for DL6315STLI-2)

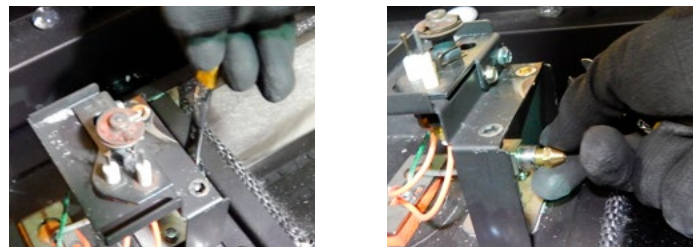

Figure 13.c Removing the orifice

5. Use screwdriver to carefully detach spring clip from the pilot hood. (Spring clip will be reused)



Figure 13.d Removing the spring clip

6. Remove pilot hood, then use allen key to remove pilot orifice.

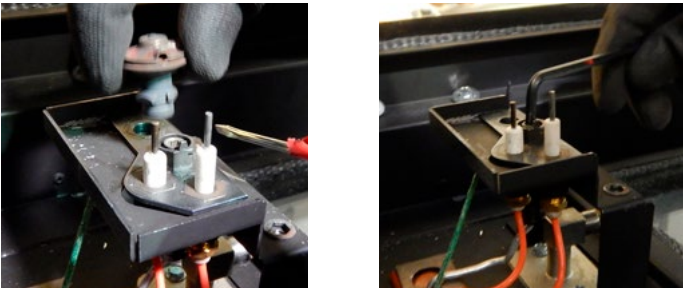

Figure 13.e Removing the pilot hood, orifice

7. Insert Propane pilot orifice. Reassemble burner assembly.

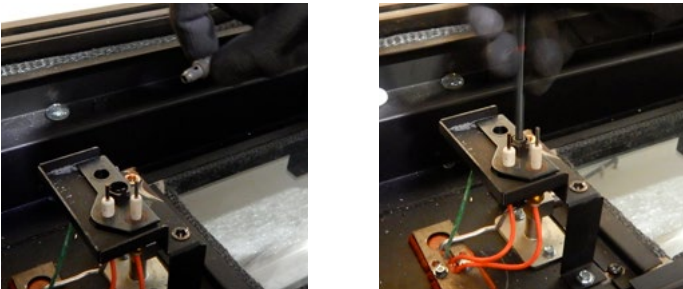

Figure 13.f Insert propane orifice, reassemble burner

8. The pilot size can be adjusted using a flathead screwdriver to adjust "pilADJ" screw shown



Figure 13.g Adjust pilot size

9. The manifold and inlet pressure can be verified by using a manometer and a 1/8" rubber hose attached to the valve ports shown here (top is manifold, bottom is inlet)

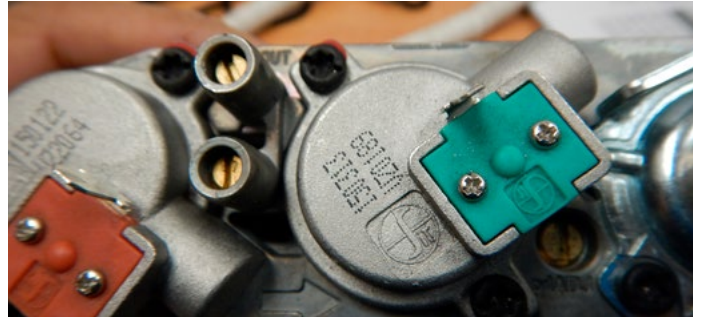

Figure 13.h Adjust pressure ports

10. Use a soap-based leak testing solution on the valve regulator while the unit is operating to check for any leaks

11. Fill out required information on Propane conversion gas fitter sign off label, attach to reverse side of rating plate. Attach Rating plate conversion label to rating plate label. Place Valve conversion label on valve face.

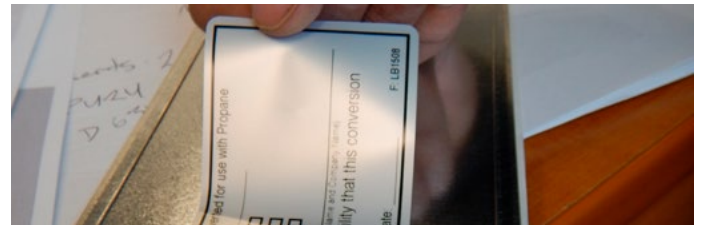

Figure 13.i Label reverse rating plate

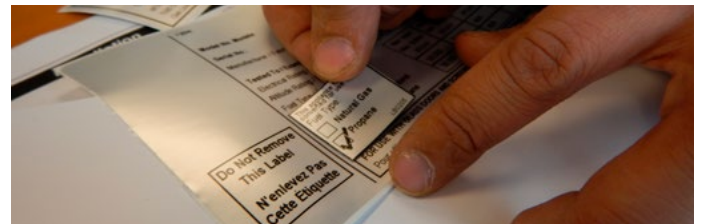

Figure 13.j Conversion label on rating plate label



Figure 13.k Conversion label on valve

Section 4: Wiring

D6315 (ST) (N/L) I-2 Wiring Diagram

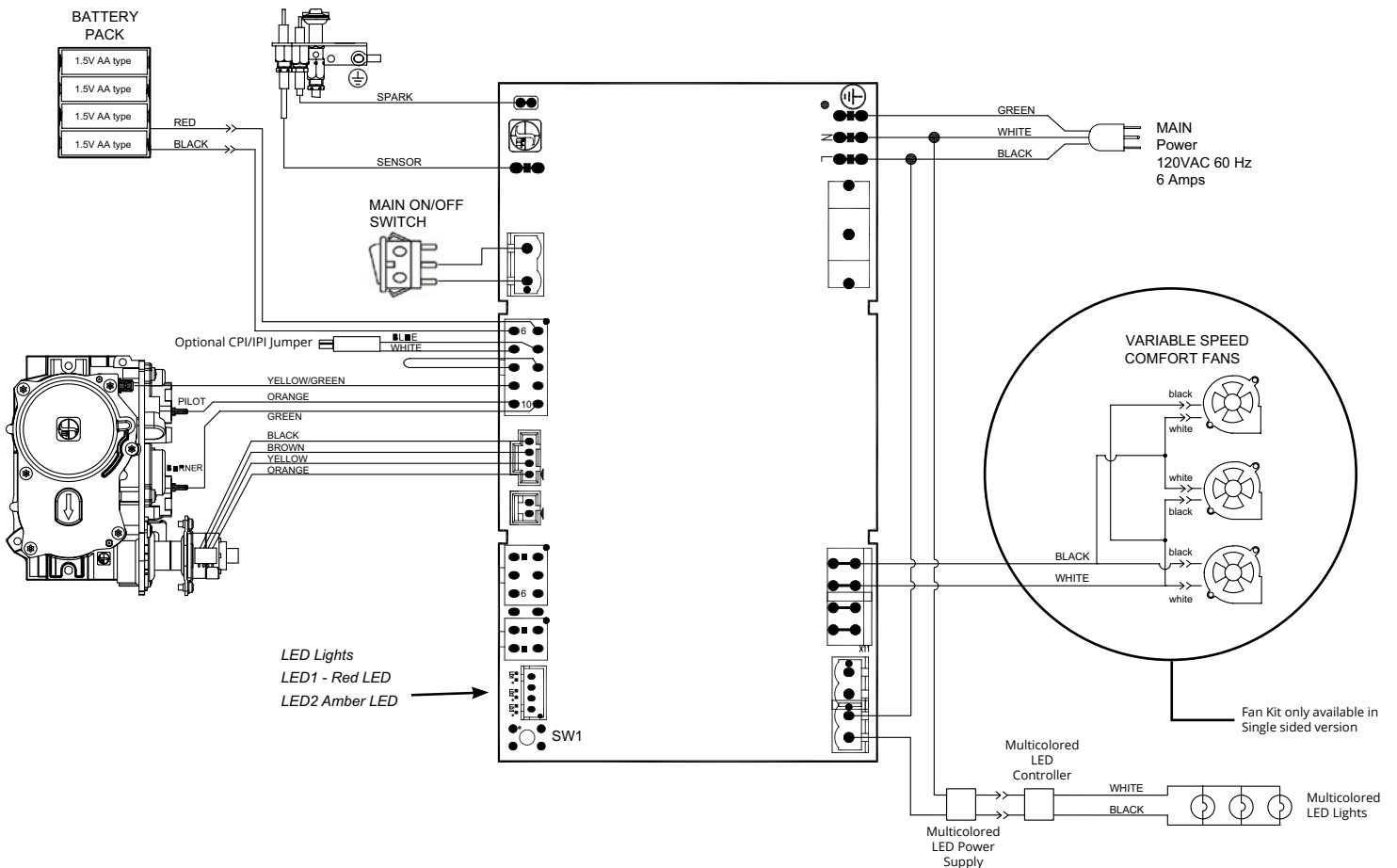

Figure 14. D6315 (ST) (N/L) I-2 Wiring Diagram

Installation of Electrical Supply

Installations in Canada must be electrically grounded in accordance with CSA C22.1 Canadian Electrical Code Part 1 and/or Local Codes.

Installations in the USA must be grounded in accordance with local codes or, in the absence of local codes, with the National Electrical Code, ANSI/NFPA 70.

NOTE: If any of the original wire supplied with the appliance is replaced, it must be replaced with the same type, or its equivalent.

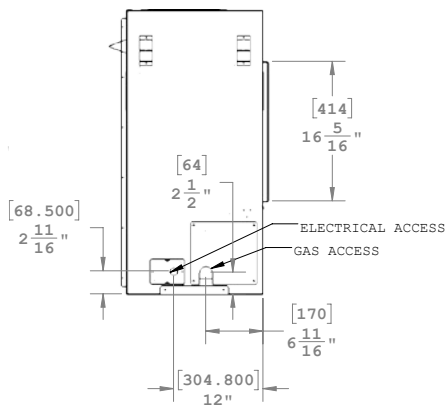

Figure 14.b Electrical Supply location on Single Sided unit

DL6315 (ST) (N/L) I Wiring Diagram

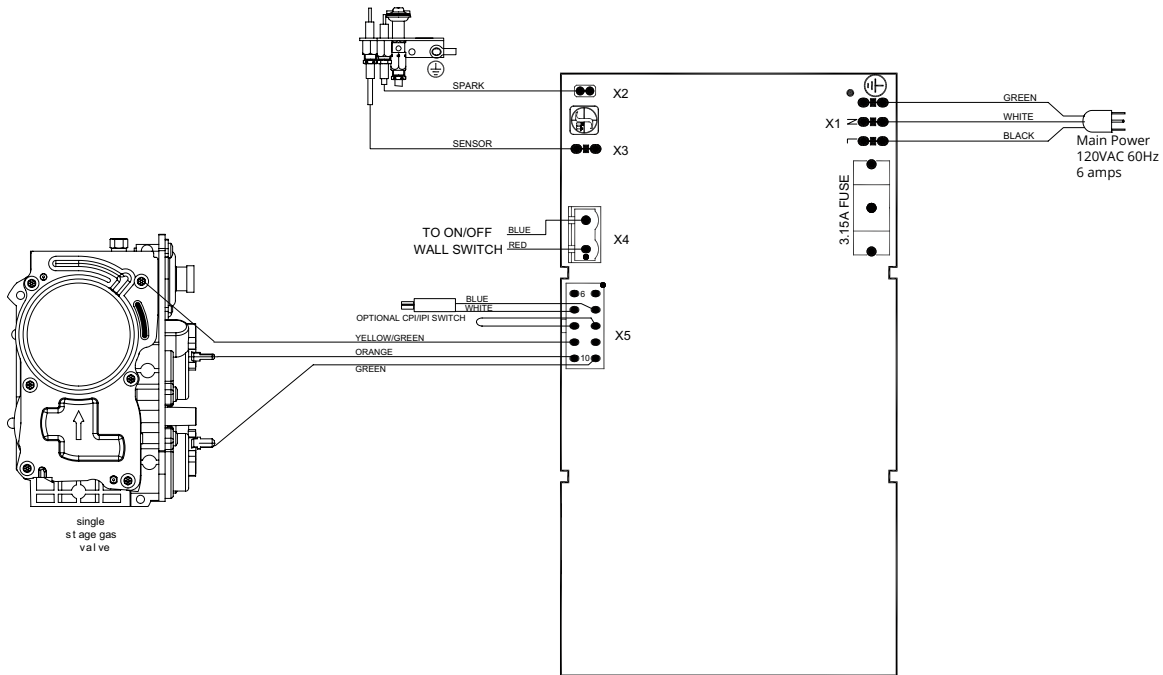

Figure 15. DL6315 (ST) (N/L) I Wiring Diagram

Installation of the wall switch

Montigo supplies 15' of low voltage wire to be plugged into the control board. Connect to a standard single pole ON/OFF switch to the location of your choice. You may extend these wires up to 100' in length with a wire of equal quality.

Installations in Canada must be electrically grounded in accordance with CSA C22.1 Canadian Electrical Code Part 1 and/or Local Codes.

Installations in the USA must be electrically grounded in accordance with local codes or, in the absence of local codes, with the National Electrical Code, ANSI/NFPA 70.

Optional remote control available through your Montigo Dealer.

POD - Pilot on Demand

What is POD and CPI mode?

This fireplace is equipped with an "On Demand" intermittent pilot ignition system (IPI) which also includes a continuous pilot ignition (CPI) mode with an integrated seven day timer.

In IPI mode, the pilot will light before the main burner, when the appliance is turned on using a wall switch, remote or from a thermostat. Once the appliance is turned off, the main burner and pilot flame will shut down.

The continuous (CPI) mode exists to ease the startup phase in colder climates by keeping the firebox and venting warm when the main burner is not in use. The timer automatically switches off the pilot when the appliance has not been used for seven days.

When the CPI function is turned on, the pilot will remain on after the fireplace is turned off. A timer will then begin the countdown for approximately seven (7) days before shutting off the pilot if the appliance is not used. This countdown will reset anytime the burner is used.

If your appliance is equipped with a remote control device capable of selecting IPI / CPI modes, refer to remote operating instructions.

In order to start your pilot, turning the main burner on with the switch, remote or thermostat and then turning it off will reactivate the continuous pilot mode and reset the seven day timer.

A jumper is supplied with this unit that can be plugged into the wire harness connected to the controller. This jumper cable gives the Remote Control the ability to operate the POD / IPI switch and set the unit to operate in either condition. Please refer to jumper installation instructions for more information.

Remote Continuous Pilot (CPI) Selection

Requires installation of the CPI JUMPER

With the system in "off" position press the Mode Key, to index to the CPI mode icon, Pressing the Up Arrow Key will activate the Continuous Pilot Ignition mode (CPI). Pressing the Down Arrow Key will return to IPI. A single "beep" will confirm the reception of the command.

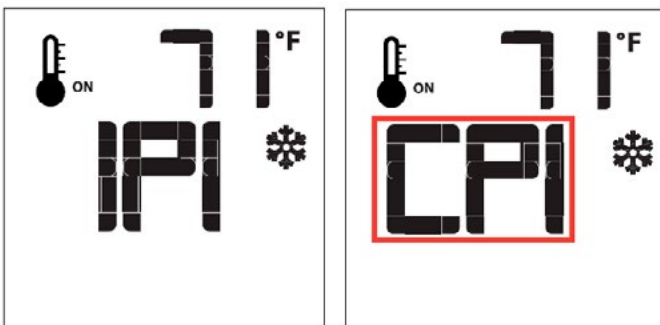

Installing the CPI Jumper Cable

1). Access the control box.

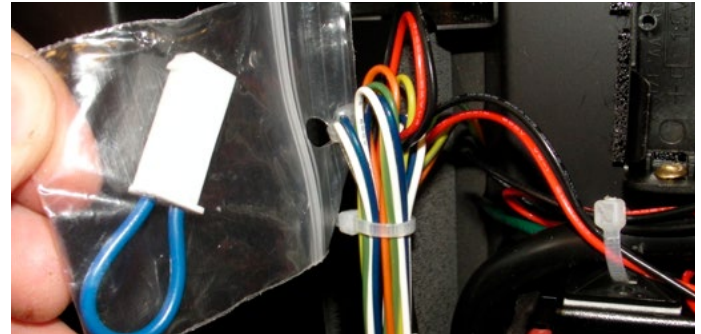

Figure 19.a Open the control box drawer

2). Remove the bag containing the Jumper Cable from the wire harness connected to the controller.

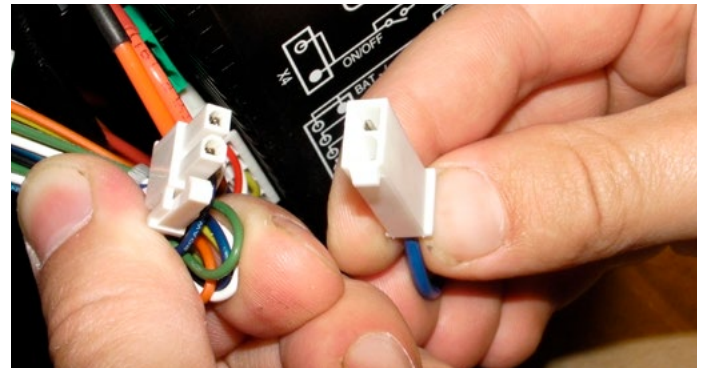

Figure 19.b Locate Jumper cable

3). Find the corresponding plug attached to the control wire harness and connect the CPI jumper.

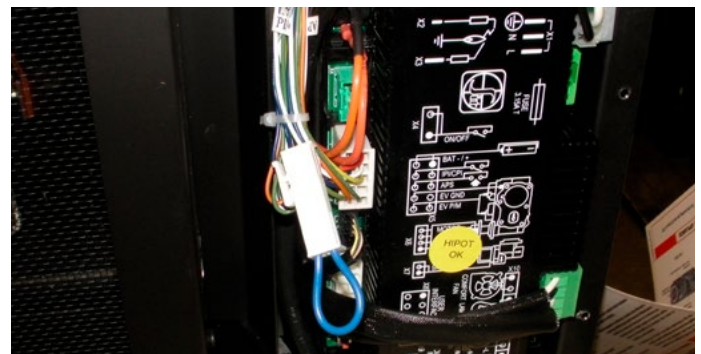

Figure 19.c Connect CPI

4). See operation section to turn remote into CPI mode.

Section 5: Installing the gas line

Fuel Type

Verify that your fireplace is compatible with your available gas type. Natural Gas or Propane shown by "N" or "L" in your model number on rating plate. See page 26 for instructions on converting to propane.

Gas Pressure

Optimum appliance performance requires proper input pressures. Gas line sizing requirements will be determined in ANSI Z221.3 National Fuel Gas Code in the USA and CAN/CGA B149 in Canada.

Pressure requirements (during operation):

D6315 Pressure Requirements		
Model	Minimum	Maximum
DL6315NI DL6315STNI DL6315NI-2 DL6315STNI-2	5.5" W.C. 0.2 PSIG	13.8" W.C. 0.5 PSIG
DL6315LI DL6315STLI	11" W.C. 0.4 PSIG	13.8" W.C. 0.5 PSIG
DL6315LI-2 DL6315STLI-2	12.5" W.C. 0.45 PSIG	13.8" W.C. 0.5 PSIG

Figure 17. D6315 Pressure Requirements

The manifold outlet pressure is set from the factory to the appropriate pressure but should be verified.

To check pressures, use a manometer and a 1/8" rubber hose attached to the inlet or manifold valve ports.

Only install gas shut-off valves approved for use by the state, province, or other governing body in which the fireplace is being installed.

⚠ DANGER

After gas line is connected, each appliance connection, valve and valve train **MUST** be checked while under normal operating pressure with either a Liquid Solution, or Leak Detection Device, to locate any source of leak. Tighten any areas where bubbling appears or a leak is detected until bubbling stops completely or leak is no longer detected. **DO NOT** use a flame of any kind to test for leaks. A fire or explosion will occur, causing serious injury, property damage or death.

NOTICE

When pressure testing the fireplace, Gas line, and input system follow the appropriate local codes for your area. **DO NOT** connect the fireplace to pressures in excess of 1/2 lb. This will damage the gas control valve.

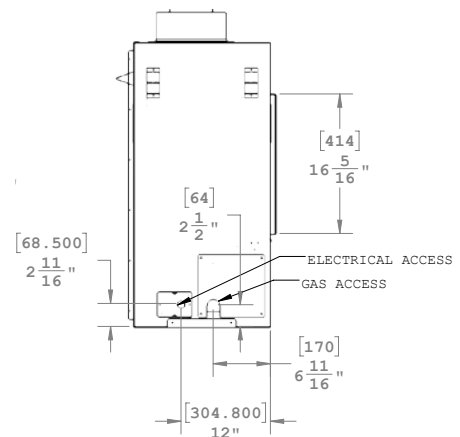

Figure 18. Gas Inlet Supply location (Single Sided)

Gas Connection

Flexible gas connectors must not exceed 3 feet in length, unless allowable within local regulations.

Connect incoming gas line to the 1/2" Male NPT gas inlet.

Purge all air out of gas line before connecting port.

Check appliance connection, valve and valve train under normal operating pressure with a commercially available leak check solution.

DO NOT USE A FLAME OF ANY KIND TO TEST FOR LEAKS.

Mantels & Surrounds

NOTE: National Canadian Gas Association mantel test requirements are for fire hazard prevention to combustible materials.

New technology, to meet consumer and government demands for the wise use of energy, has prompted us to manufacture many models of fireplaces which are hot, fuel and energy efficient.

Please be aware; temperatures over the mantel will rise above normal room temperature and walls above fireplace may be hot to touch.

We recommend careful consideration be given to the effects of elevated mantel temperatures which may be in excess of product design, for example: candles, plastic or pictures. This can cause melting, deformation, discoloration or premature failure of T.V. and radio components.

Side wall clearances are 6". Combustible surrounds may be installed with 6" clearance to the side of the fireplace as shown.

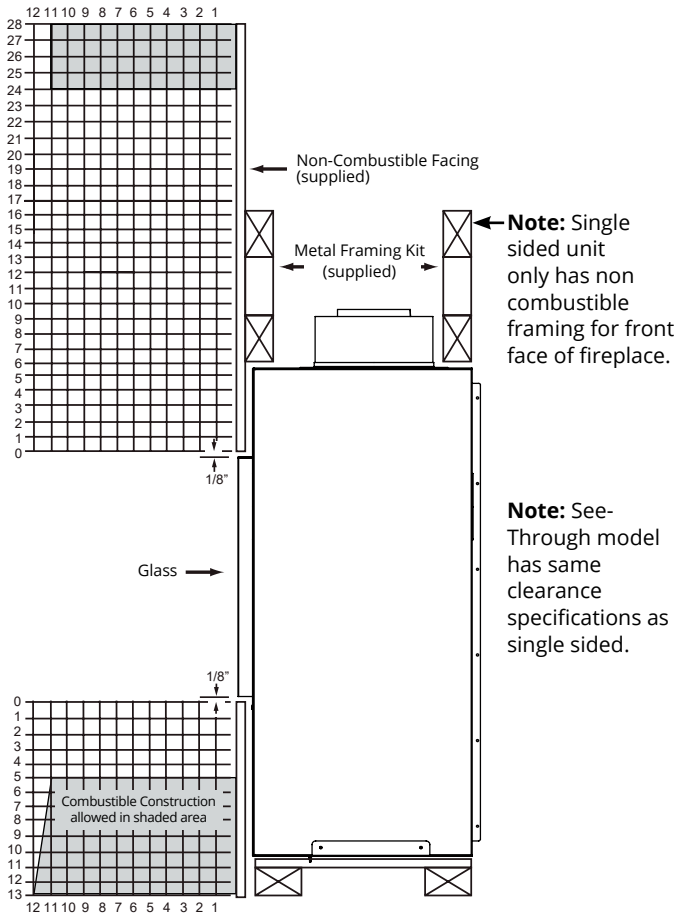

Figure 19. Combustible mantels and facings. (Not to scale)

Mantels & Surrounds with Cool Wall Kit

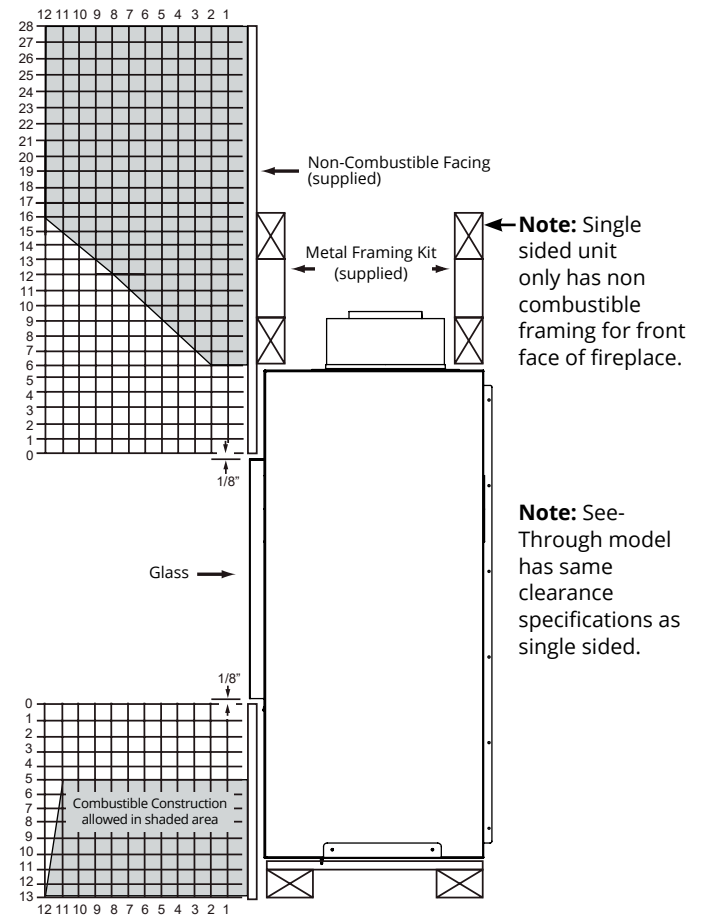

Figure 19.b Combustible mantels and facings with Cool Wall Kit. (Not to scale)

Finishing Around the Fireplace

Combustible mantels and mouldings may be safely installed over the top and on the front of the fireplace provided that they do not project beyond shaded area shown.

The face of the fireplace may be painted to match the room decor, provided you use a heat-resistant paint. Decorative facing must not extend past the fireplace opening at all, because it will interfere with the access to retainers for removal of glass door.

Rear Standoff 2"

Side Standoff 3 1/3"

Top Standoff 38.25"

Combustible Mantle Height 24"

Combustible Mantle Width 11"

Section 8: Removing & Installing the Screen

Removing the Screen

Follow the steps below to remove, or install the fireplace screen and door. Before beginning any screen or glass removal, make sure that the unit has not been in operation and that it is at room temperature.

Step 1: Prepare to Lift out Screen Assembly

Locate the three tabs at the base of the screen.



Figure 20. Locate the three tabs at the base of the screen

Step 2: Lift out the Retaining Tabs and screen.

Pull the bottom of the screen outward, then slide out the screen from the frame.

Store in a safe place. The Screen is very fragile and can be easily torn, dented or deformed. Refer to Figure 20.b below.

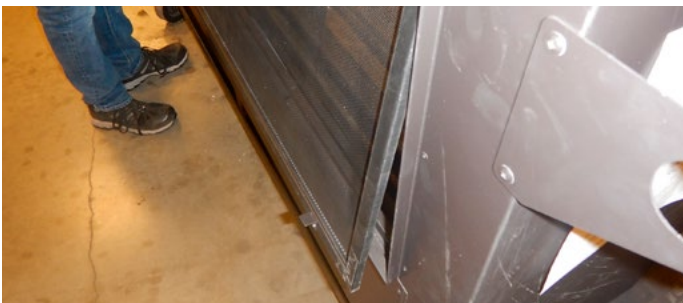

Figure 20.b Lift out the Retaining Tabs and screen

Reinstalling the Screen

Follow the two previous steps to re-install the Distinction fireplace window.

NOTICE

Any safety screen, guard, or barrier removed for servicing an appliance, must be replaced prior to operating the appliance

Removing & Installing the door

Removing the door:

The Distinction doors are removed in a few simple steps. Follow these steps below to unlatch the door buckles and, remove the door. Replace in reverse order.

WARNING

When reinstalling the door(s), always make sure all door buckles are properly hooked and fully engaged.

TOOLS NEEDED:

Door buckles will be released using the door removal tool.



Figure 21. door removal tool

STEP 1:

Locate door buckles

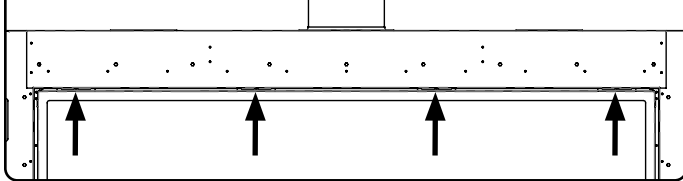

Figure 21.b Locate door buckles

WARNING

Do not operate appliance with the glass front removed, cracked, or broken. Replacement of the glass should be done by a licensed or qualified service person

STEP 2:

The 4 door latches are holding the door in place with spring pressure.

(Caution: The latch springs back with force, hold the tool securely).



Figure 21.c Locate door latches

STEP 3:

Ensure the tool is firmly in the lower end of the slot, (as shown), Then pull toward you (Caution: hold the tool securely).

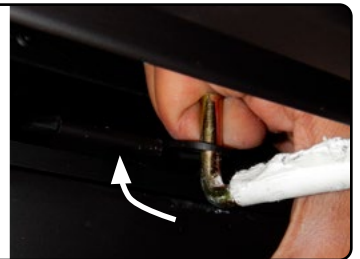

Figure 21.d Pull door latches

STEP 4:

Lift the latch upward and off of the door flange. Pull hard if necessary to release the spring tension.

(Repeat all 4-steps for the remaining latches).



Figure 21.e Lift the latch upward

STEP 5:

Pull the top of the door towards you, then lift the door up and out of the fireplace frame.

Store in a safe place.

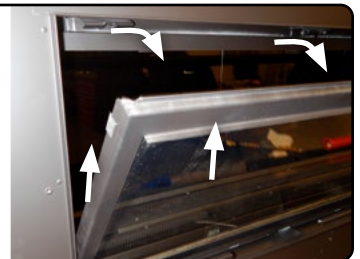

Figure 21.f Lift the door up and out of the fireplace frame

Reinstalling the door

Follow the previous steps in reverse to re-install the fireplace door.

NOTE: Make sure the base of the door slips into the narrow channel in the frame to ensure proper placement and to prevent damage.

Section 9: Installing the Fireglass

The unit is supplied with fireglass. To install the fireglass remove the door as shown in the previous section. Follow these instructions to ensure all parts are removed or replaced as required. Once the screen and glass door is removed, place the firestones evenly on the media tray as shown in Figures 22 and 22a.

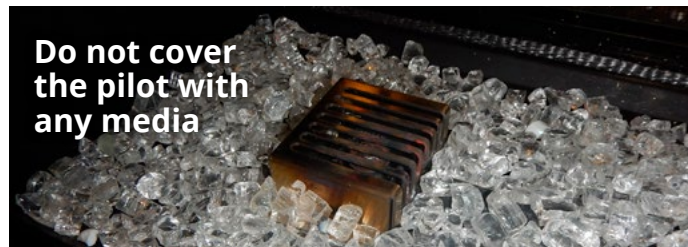

Figure 22. Do not cover the pilot with any media



Figure 22.b Completed glass Firestone installation.

Firestone & Fireglass Quantity

Requires four 3lbs bags for a total of 12lbs of firestones

Requires four 3lbs bags for a total of 12lbs of firestones

Optional speckled stones

The unit has the option of installing the Speckled Stone. These may be spaced at random, or in a visual pattern of your preference. See the Montigo web site for photographs and ideas.

www.montigo.com

Optional Log Set

The Fireplace has the option of installing a drift wood log set. Once the base media of fireglass, firestones, or speckled stones has been placed the log set can be installed. Ensure logs are securely placed and will not tip or fall. NO LOGS SHOULD LAY ACROSS OR OVER TOP OF THE BURNER FLAME.

Log Kit Installation

Log kits used to create sequence shown: 1 LGS58, 1 LGS59



Figure 23. LGS59

STEP 1: Place log E from the LGS59 kit to the left of the pilot, in the rear left corner of the unit.



Figure 23.b

STEP 2: Place log A resting on log E, with the other end resting just beside the pilot.



Figure 23.c

STEP 3: Log 4 is placed horizontally against the rear of the firebox.

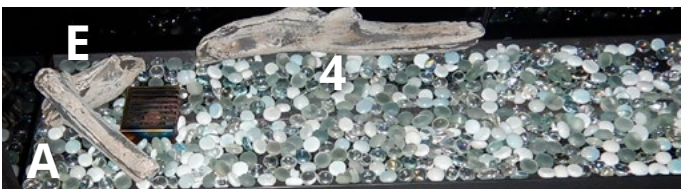

Figure 23.d



Figure 23.e LGS58

STEP 4: Place log D parallel to log 4, at the front edge of the burner tray.



Figure 23.f

STEP 5: In the centre of the firebox, place log 1 laterally in front of the burner.



Figure 23.g

STEP 6: Place log C slightly angled and to the right of log 1, and against the rear of the burner tray.



Figure 23.h

STEP 7: Place log B with one end resting on top of log C.



Figure 23.i

STEP 8: Place log 5 at the front of the burner tray.



Figure 23.j

STEP 9: Log 6 is placed leaning on log 5 near the front of the firebox.



Figure 23.k

STEP 10: Place log number 3 diagonally in the rear right corner of the firebox.



Figure 23.l

STEP 11: Log 2 rests with one end on top of log 3.



Figure 23.m

STEP 12: Finish the log installation by placing log F on the other end of log number 3.

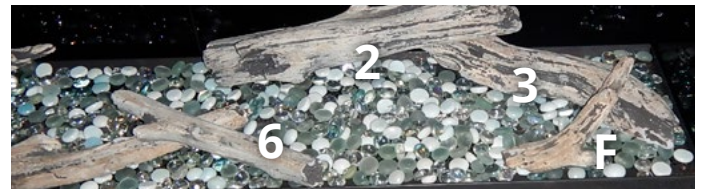

Figure 23.n

Control Board upgrade/replace

Adding options to DL units requires control board upgrades for the following options

Fan Kit DFK-3
LED Kit MCLEDDL63
Remote Control
Stepper Motor
Powervents

When upgrading the Distinction control board, the board will be shipped with the board installed in the drawer and with the appropriate cables installed.

1. Remove existing basic board drawer by unplugging all existing connections.

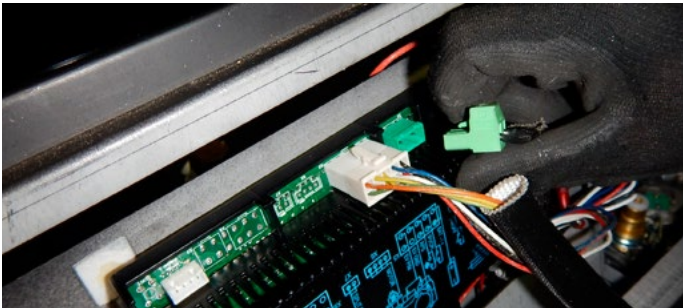

Figure 24. Remove existing basic board

2. Unplug PPO from board located underneath the pilot assembly. Disconnect the ground and remove drawer completely.



Figure 24.b Remove existing basic board



3. Discard old drawer and wall switch and valve wires.

4. New Board.

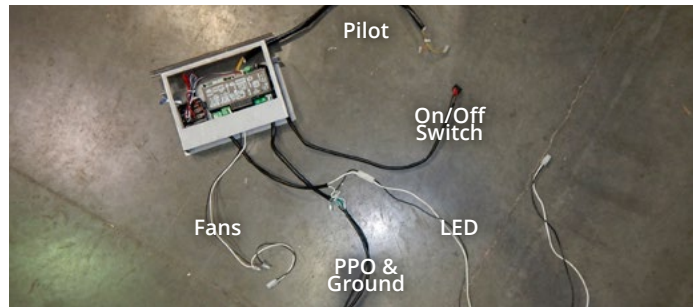

Figure 24.c Proflame2 Board

D6315 (ST) (N/L) I-2 Wiring Diagram

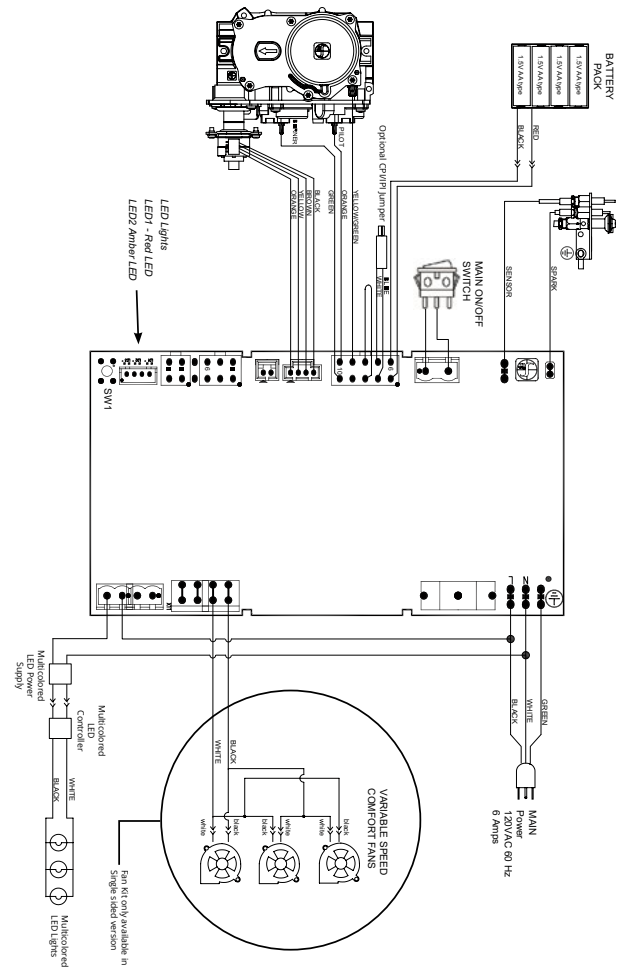

Figure 24.d D6315 (ST) (N/L) I-2 Wiring Diagram

5. Feed On/Off switch through drawer frame



Figure 24.e On/Off switch through drawer

6. Feed Fan, LED, PPO, and pilot wires through drawer frame.

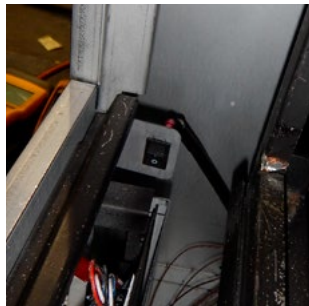

Figure 24.f Fan, LED, PPO, and pilot wires through drawer

7. Disconnect On/Off switch and feed cable through drawer frame. Install in space on left inner wall.



Figure 24.g On/Off switch



8. Place Fan wire on leftside firebox floor with adhesive wire pad. For fan Install instructions see **Optional fan kit Install/Replace** instructions



Figure 24.h Fan wire

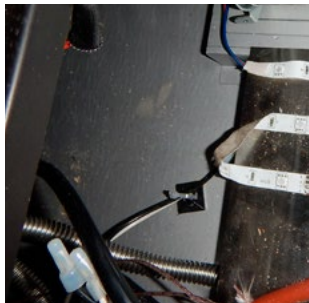

9. Place on LED wire on rightside firebox floor with adhesive wire pad. For LED Install instructions see **Optional LED kit Install/Replace** instructions

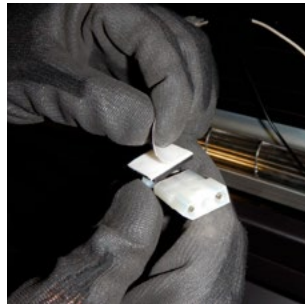
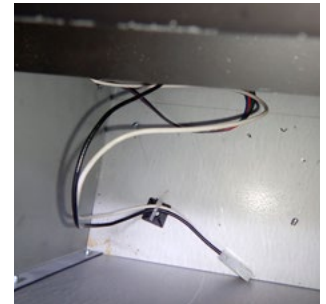

Figure 24.i LED wire



10. Loop Pilot wires from behind control board drawer to the front. Plug into X2 and X3

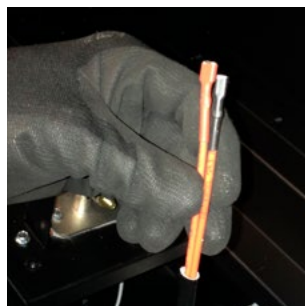

Figure 24.j Pilot wires



11. Valve wires are plugged into the valve in the Green, Red, and yellow ports respectively.

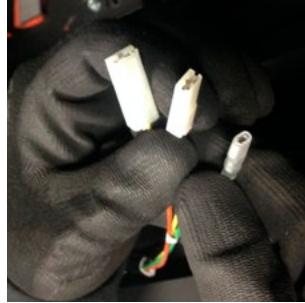

Figure 24.k Valve wires



LED Strip Installation (Optional Accessory)

LED Strip Instructions

Power to the unit MUST be disconnected before installing

For instructions on how to remove the door please see the door install/removal section.

For instructions on how to remove the burner tray please see the burner tray section.

1. Secure LED receiver and AC adaptor to the bottom inside face of the firebox with Velcro strips.



Figure 25.a. Secure LED receiver

2. Insert and secure LED plate.

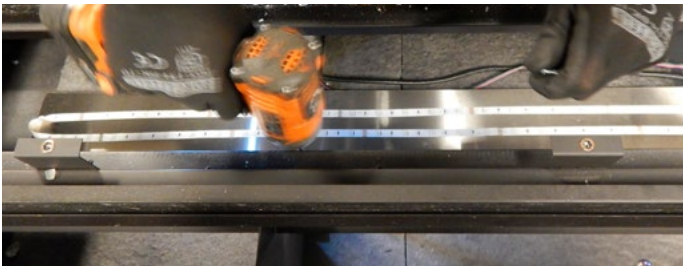

Figure 25.b. Secure LED plate

3. Connect LED strip to LED receiver, and power to AC adaptor.



Figure 25.c. Power LED receiver

4. Place Glass plate where metal plate sat before, secure using existing metal brackets. Screw in halfway on one side first, then fully on the other side, then fully tighten first side.

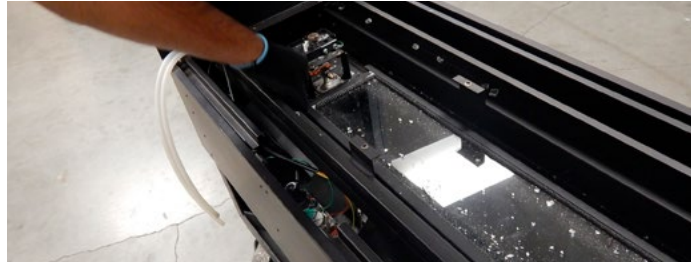

Figure 25.d. Insert glass plate

5. Reinstall burner strip.



Figure 25.e. Insert burner

6. Reinstall media tray.



Figure 25.f. Insert media tray

7. Reinstall pilot cover and door/screen.



Figure 25.g. Insert pilot cover/door/screen

Decorative panel Installation

Glass reflective panels

SEE-THROUGH UNITS NOTE: see through units panel kits include only the two side panels, follow step 2 of the below to complete installation.

Step 1: Slide back panel(s) into top track, carefully push the base of the panel onto the lower ledge.

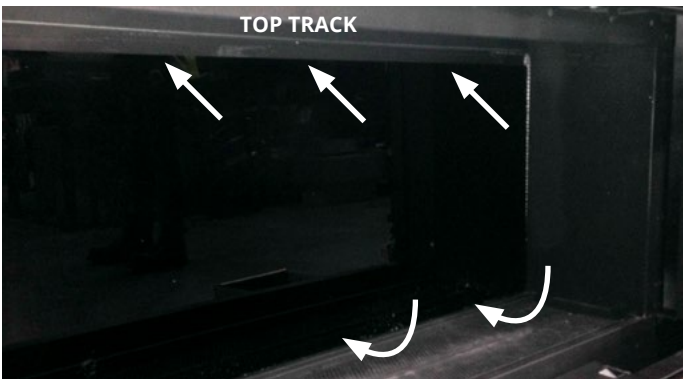

Figure 26. Remove the existing screws

Step 2: Side panels are slid into the lower track and set into place using the provided bracket and screws. Use 1/4" hex bit



Figure 26.c Secure panel

Fluted panels

SEE-THROUGH UNITS NOTE: see through unit panel kits include only the two side panels, follow step 4 of the below to complete installation.

Step 1: Bend tabs on bottom bracket slightly up, seat in track of back wall.



Figure 26.b Secure bottom of panel

Step 2: Place back liners, making sure they interlock properly. Bend tabs fully to secure.

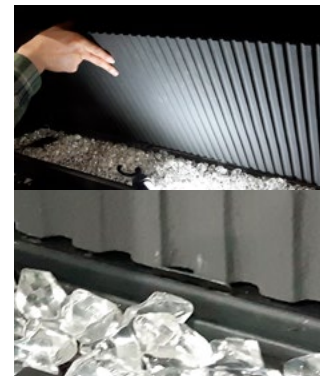

Step 3: Place top brackets on to track at the top and bend tabs down, one per panel.



Figure 26.d Secure top and sides

Step 4: Place side liners, secure with self tapping tek screw and side brackets. Repeat other side.

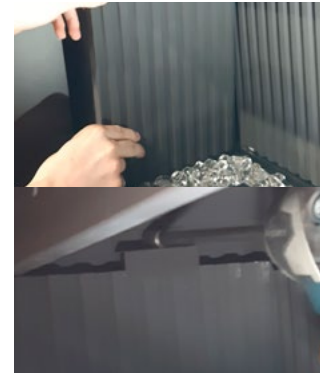

Optional stepper motor install/replace

Verify that the following items are present in the package.

- Pressure regulator assembly (E)
- Two (2) screws (F)
- Identification label (G)
- Installation instructions

- 1 Shut off the gas supply to the valve and shut down the electric supply
- 2 Using a Torx T20, or slotted screwdriver, remove and discard the two (2) pressure regulator mounting screws (A), pressure regulator tower (B), and the spring and diaphragm assembly (C), (If applicable).
- 3 Access gas valve by removing the valve blind
- 4 Ensure the rubber gasket (D), which is prefitted as part of assembly (E), is properly positioned, otherwise fit the gasket as shown.
- 5 Install the new STEPPER MOTOR pressure regulator assembly, as shown in Fig. 3 and Fig. 4. Use the supplied screws (F)
- 6 Manually thread the two conversion kit mounting screws into the valve body. Use a standard screwdriver or T20 Torx bit and tighten to the screws with a fixing torque of 251b-in \pm 5%.

IN THE EVENT THAT THE THREADS OF THE VALVE ARE STRIPPED OR DAMAGED, REPLACE THE VALVE.

- 7 Install the enclosed identification label (G) to the valve body where it can be easily seen.
- 8 Make STEPPER MOTOR and valve electrical connections, apply gas to system and relight appliance according to manufacturers instructions.
- 9 With the main burner "ON", test the new pressure regulator assembly for leaks using a soap solution.
- 9 Relight the main burner and verify proper burner ignition and operation

WARNING!

Do not use power drill.

WARNING!

Installation should be carried out in a clean environment.

WARNING!

This modulating conversion kit must ONLY be applied as part of a conversion kit supplied by montigo for the specific appliance, and type of fuel, being converted.

WARNING!

Correct operation of the system cannot be guaranteed if the conversion kit or valve has been dropped or has sustained a strong impact.

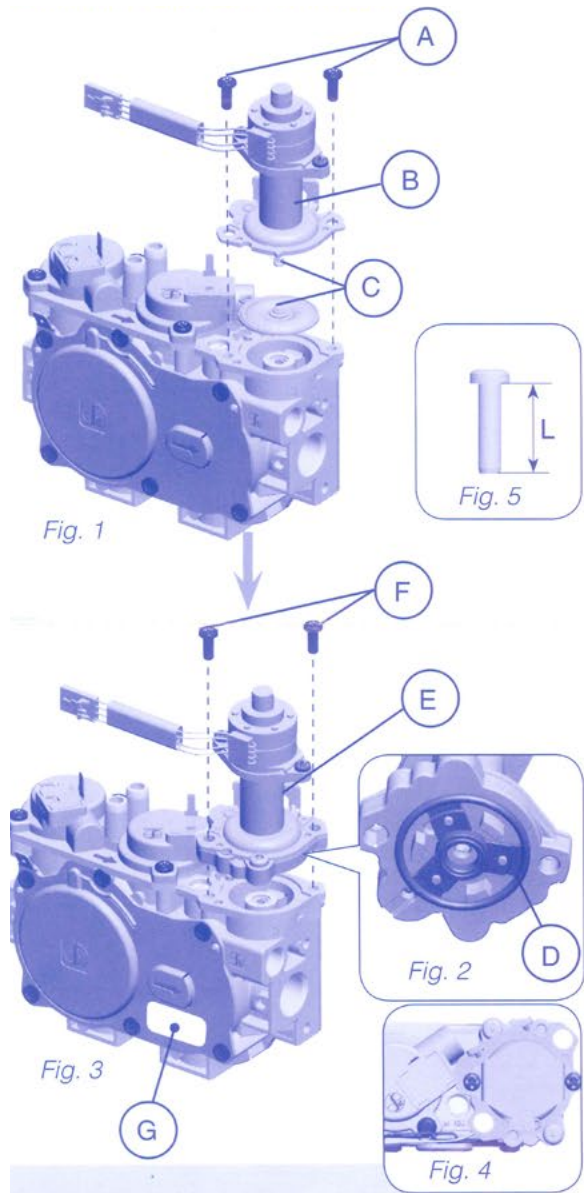

Optional Fan kit Install/Replace



Figure 27. Fan kit

Before you begin:

This optional kit requires a Control board upgrade to the Proflame 2. For burner and media tray removal instructions please see first 7 steps in burner tray removal instructions.

Kit Contents:

- 3 Fans
- 1 Fan Harness

WARNING

When installing the fireplace - gas lines, fittings, accessories or any other objects cannot impede the proper movement of the door buckles.

1. Remove the plastic covering from the 4 velcro strips on the fans.



Figure 27.b prepare velcro strips

2. Starting with the left side, secure the fans in the bottom of the firebox flush against the bottom and back as shown.

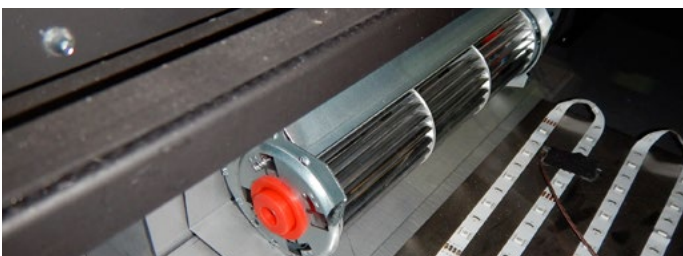

Figure 27.c secure the fans

CAUTION

Ensure that all power to the appliance is off at the electrical breaker or fuse before beginning installation. Ensure gas is turned off at the shutoff valve before beginning installation.

3. Repeat for two remaining fans, making sure connectors are on the right side.



Figure 27.d secure the fans

4. Locate fan wiring harness.

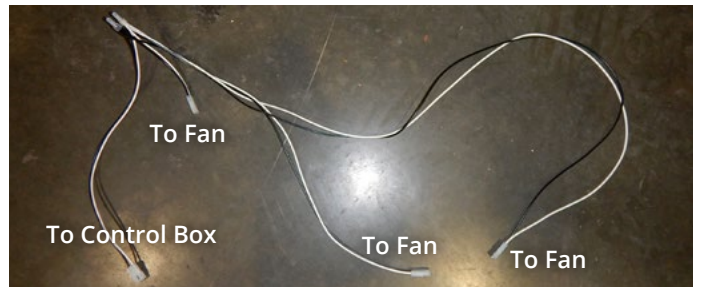

Figure 27.e Locate fan wiring harness

5. Connect control board connector (located fastened on the bottom left side of the firebox) to fan harness.



Figure 27.f Connect control board connector

6. Connect fans to harness connectors, tuck wires away from LED strip.

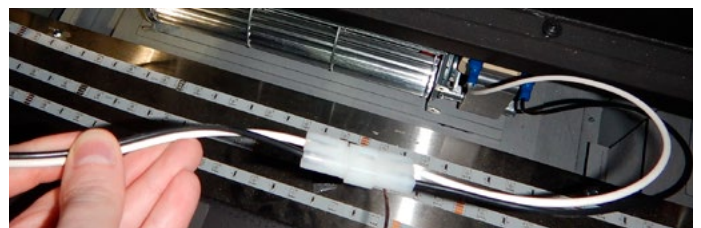



Figure 27.g Connect fans to harness connectors

FOR YOUR SAFETY - READ BEFORE LIGHTING:

DANGER



**HOT GLASS WILL CAUSE BURNS.
DO NOT TOUCH GLASS UNTIL COOLED.**

NEVER ALLOW CHILDREN TO TOUCH GLASS.

A barrier designed to reduce the risk of burns from the hot viewing glass is provided with this appliance and must be installed for the protection of children and other at-risk individuals.

WARNING: If the information in these instructions is not followed exactly, a fire or explosion may result causing property damage, personal injury or death.

WARNING/ CAUTION: Hot while in operation. Do not touch. Severe burns may result. Keep children, clothing, furniture, gasoline and other liquids having flammable vapours away.

See installation and operating instructions accompanying this appliance for more information.

A. This appliance is equipped with an ignition system that lights the pilot burner automatically. **Do not attempt to light the pilot by hand.**

B. **BEFORE LIGHTING** smell all around the appliance area for gas. Be sure to smell next to the floor because some gas is heavier than air and will settle on the floor.

What To Do If You Smell Gas:

- Do not try to light any appliance.
- Do not touch any electrical switch; do not use any phone in your building.

- Immediately call your gas supplier from a neighbour's phone. Follow the gas supplier's instructions.

- If you cannot reach your gas supplier, call the Fire Department.

C. Use only your hand to operate gas control. Never use tools. If the control does not function, don't try to repair it, call a qualified service technician. Force or attempt to repair may result in a fire or explosion.

D. Do not use this appliance if any part has been under water. Immediately call a qualified service technician to inspect the appliance and to replace any part of the control system, and any gas control which has been under water.

LIGHTING INSTRUCTIONS:

1. **STOP!** Read the safety information above on this label.
2. Turn "ON" manual "ON/OFF" switch. (If available)
3. Turn Incoming gas shut off valve to the "ON" position.
4. Wait 5 minutes to clear out any gas. If you smell gas, **STOP!** Follow "B" in the safety information above on this label. If you don't smell gas, go to the next step.
5. Turn fireplace "ON" using wall switch or remote control.
6. If the Fireplace does not light, the System will cycle through two trials, (one minute audible clicking, thirty seconds of silence, and then another one minute of audible clicking). If the system locks out due to inadequate gas flow, refer to "Troubleshooting" in instruction guide.
7. After completion of the information in the Troubleshooting section, Repeat step 5.
8. If the system will not function correctly, follow the instructions "To Turn Off Gas To Appliance" and call your service technician or gas supplier.

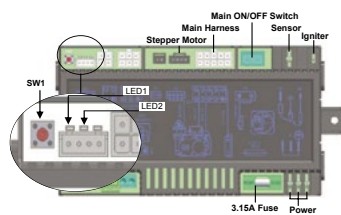

SW1 = Programming Button
 LED1 = Red Diagnostic Light
 LED2 = Amber Programming Remote Control Light
 Typical Control Module shown

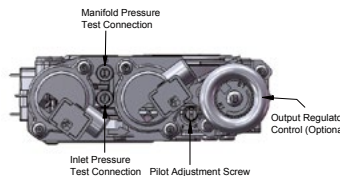

Gas Valve

TO TURN OFF GAS TO APPLIANCE:

1. Turn off fireplace using wall switch or remote control.
2. Turn the incoming gas shut off valve to "Off".

P/N LB176-060614

Section 7: Finishing the fireplace

Install the supplied non-combustible cement board to overlap the new horizontal & vertical 2 x 4's, place the non-combustible wall board above the fireplace throat, allowing 1/8" clearance from the rim above the fireplace opening. Pre-drill the board with 1/8" drill bit and secure to framing with nails, use flat heat sheet metal screws to fasten the board to the metal header.

SINGLE SIDED

Top (Qty 1)
Sides (Qty 2)
Bottom (Qty 1)

SEE-THRU

Top (Qty 2)
Sides (Qty 4)
Bottom (Qty 2)

Cut standard Gyproc / Drywall board to complete the installation of the surround. Fit the edge of the board to the rim around the fireplace opening. Fasten the board in place using standard drywall screws.

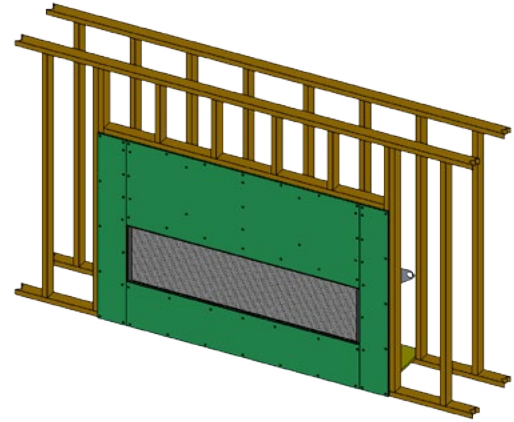

Figure 28.b non-combustible cement board with framing

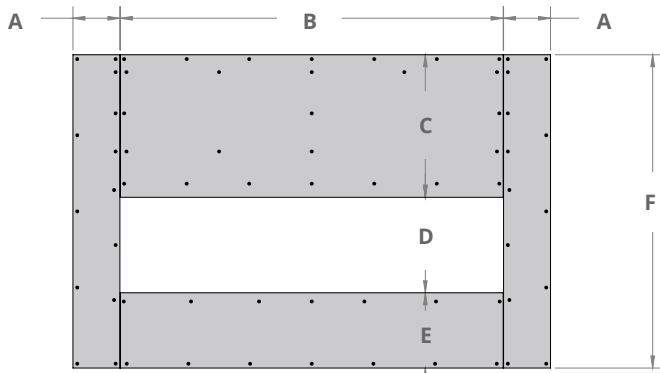

Figure 28. supplied non-combustible cement board dimensions

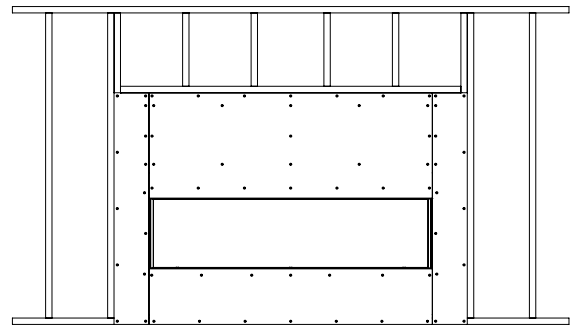

Figure 28.c non-combustible cement board with framing

D6315, DL6315	
A	8 1/8"
B	66 1/8"
C	24 5/8"
D	16 1/2"
E	13"
F	54 1/8"

Remote Operation

The Proflame 2 System consists of the following elements:

1. Pilot Assembly
2. Proflame Gas Valve.
3. Proflame 2 Control Module
4. Wiring Harness
5. Variable Speed fans
6. AUX Button turns power ON to the LED Controller
7. Proflame 2 remote control
8. Battery Pack
- 9 Manual override switch

NOTE: Can not be used with home automation systems.

The Proflame 2 Transmitter controls the following fireplace functions:

1. Main Burner On/Off
2. Main Burner flame modulation (6 levels).
3. Choice of standing or intermittent pilot (CPI/IPI).
4. Thermostat and Smart thermostat functions.
5. AUX Button turns power ON to the LED Controller
6. Fan speed modulation (6 levels).

The Proflame 2 Transmitter uses a streamlined design with a simple button layout and informative LCD display. A Mode Key is provided to index between the features and a Thermostat Key is used to turn On/Off or index through Thermostat functions, see Figure 26. Additionally, a Key Lock feature is provided.



Figure 29. Proflame 2 Remote

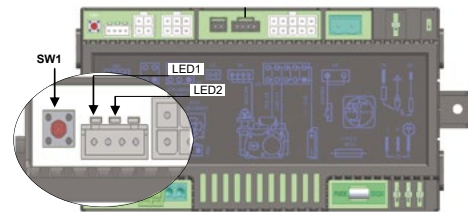

SW1 = Programing Button
 LED1 = Red Diagnostic Light
 LED2 = Amber Programing Remote Control Light

Figure 29.b Proflame 2 Control Module

⚠ WARNING

Do not expose remote control to temperatures below 0°C (32°F) or above 50°C (122°F)

⚠ CAUTION

Property Damage Hazard. Excessive heat can cause property damage.
 The appliance can stay lit for many hours. Turn off the appliance if it is not going to be attended for any length of time.

⚠ WARNING

Battery operated device. Read the battery instructions before installing them into the system. Do not expose any battery, or its holder, or a device in which batteries are installed, to a working temperature greater than 54°C / 129°F

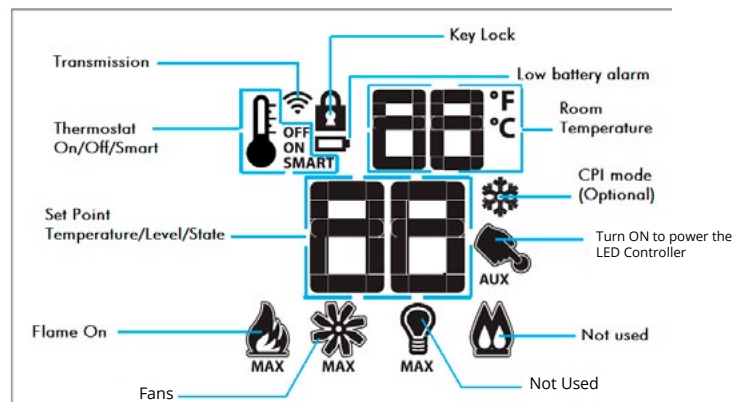

Figure 29.c Remote Control LCD Display

Initializing the System for the first time

1. Set master override switch to off position.
2. Install four (4) AA batteries into the battery holder.
3. Install three (3) AAA batteries in the back of the remote control. Note the polarity of batteries and install them as indicated by the silk screen (+/-) on the holder.
4. Connect AC Power (115 volts, 60 Hz) to fireplace.

Operating the System for the first time

Press SW1 button on the control module. The control module will beep three (3) times and an amber LED is illuminated to indicate that the IFC (control board) is ready to synchronize with a remote control within 10 sec. Push the ON button. The control module will "beep" four (4) times to indicate transmitter's command is accepted.

The System is now initialized.

Temperature Indication Display

With the system in the "Off" position, press the Thermostat Key and the Mode Key at the same time. Look at the LCD screen on the Remote Control to verify that a C or F is visible to the right of the Room Temperature display.

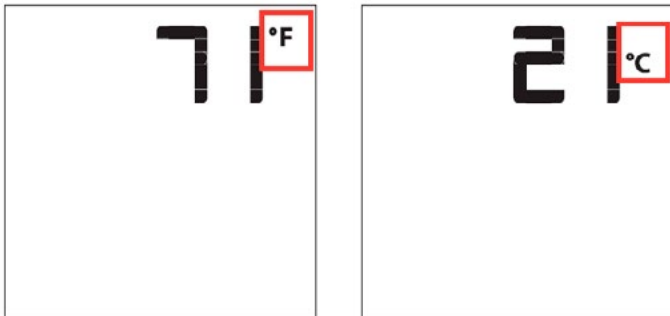

Figure 27.e Remote Control display in Fahrenheit & Celsius

Turn On the Fireplace

With the system Off, turn the master override switch to on and press the On/Off Key on the Remote Control. The Remote Control display will show some other active Icons on the screen. At the same time the Control Module will activate the fireplace. A single "beep" from the Control Module will confirm reception of the command.

Turn Off the Fireplace

With the system On, press the On/Off Key on the Remote Control. The Remote Control LCD display will only show the room temperature. At the same time the Control Module will turn off the fireplace. A single "beep" from the Receiver confirms reception of the command.



Figure 27.f Remote Control Display

Remote-Flame Control

When you turn on the fireplace it starts on high. The proflame 2 has six (6) flame levels. Each time you press the Down Arrow Key once the flame height will reduce by one step.

You can continue this until the main burner flame turns off. You can still operate the accent lights and fans in this mode.

If the main burner flame is off and you press the up arrow key once, the flame will automatically go to high.

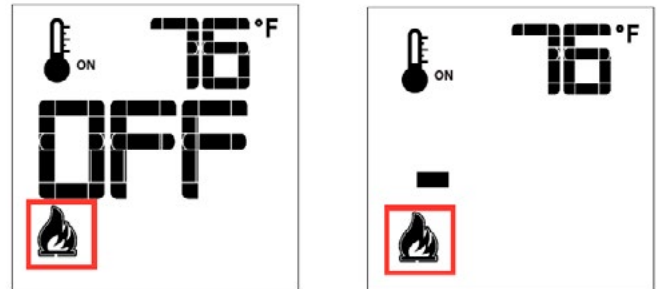

Figure 27.g Flame Off and Flame Level 1.

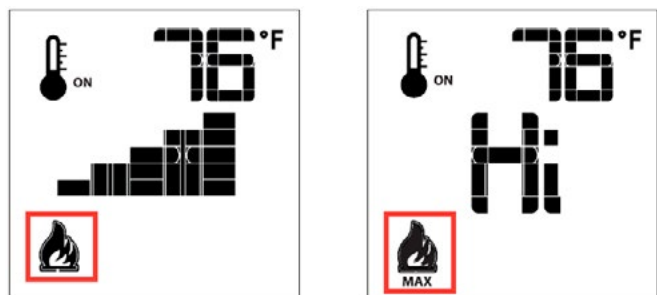

Figure 27.h Flame Level 5 and Flame Level Maximum

Room Thermostat (Remote Control Operation)

The Remote Control can operate as a room thermostat. The thermostat can be set to a desired temperature to control the comfort level in a room. To activate the function, press the Thermostat Key, see Figure 27i. The LCD display on the remote control will change to show that the room thermostat is "On" and the set temperature is now displayed. To adjust the set temperature press the Up or Down Arrow Keys until the desired set temperature is displayed on the LCD screen of the Transmitter.

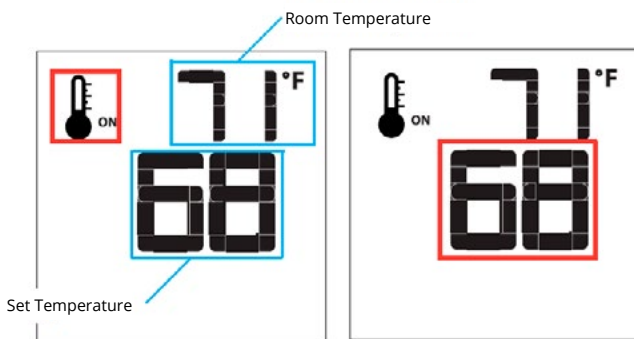

Figure 27.i Setting Room Thermostat

Smart Thermostat (Remote Control Operation)

The Smart Thermostat function adjusts the flame height in accordance to the difference between the set point temperature and the actual room temperatures. As the room temperature gets closer to the set point the Smart Function will modulate the flame down. To activate the function, press the Thermostat Key, see Figure 27.j, until the word "SMART" appears to the right of the temperature bulb graphic, see Figure 27j.

NOTE: When smart Thermostat is activated, manual flame height adjustment is disabled.

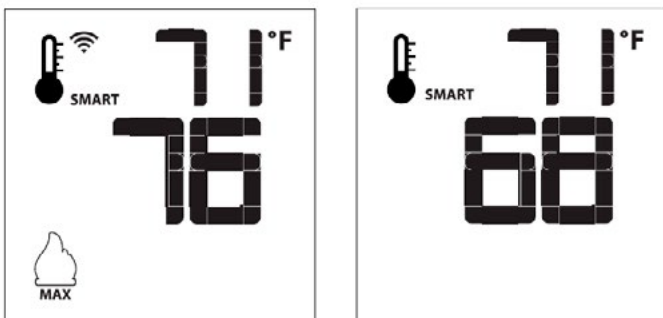

Figure 27.j Smart flame function

Disabling Thermostat

Some jurisdictions and bedroom installations require the thermostat to be disabled.

1. Partially take out one battery. Insert the battery while holding down the thermostat button. The remote screen will display 'Clr' while the button is held down.
2. To enable thermostat repeat steps 1-2. The remote screen will display 'set' while the thermostat button is held down.

Fan Speed Control

The fireplace is equipped with optional hot air circulating fans. The speed of the fans can be controlled by the Proflame system. The fan speed can be adjusted through six (6) speeds. To activate this function use the Mode Key, see Figure 27, to index to the fan control icon, see Figure 27m. Use the Up/Down Arrow Keys to turn on, off, or adjust the fan speed. A single "beep" will confirm reception of the command.

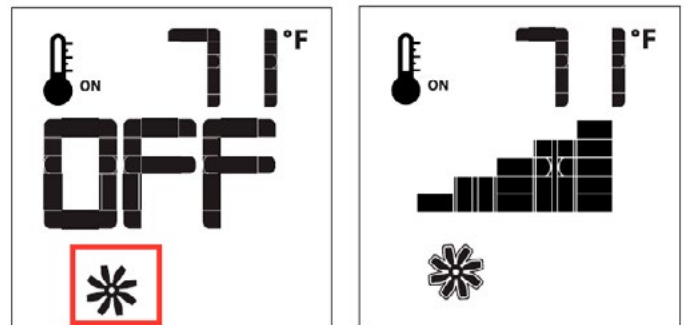

Figure 27.m Fan Speed Control

Accent Light Control

The fireplace may be equipped with accent lights. The auxiliary function controls the Accent Lights. To activate this function use the Mode Key, see figure 29, to index to the AUX icon, see figure 29n.

Pressing the Up Arrow Key will turn the light on. Pressing the Down Arrow Key will turn the light off. A single "beep" will confirm the reception of the command.

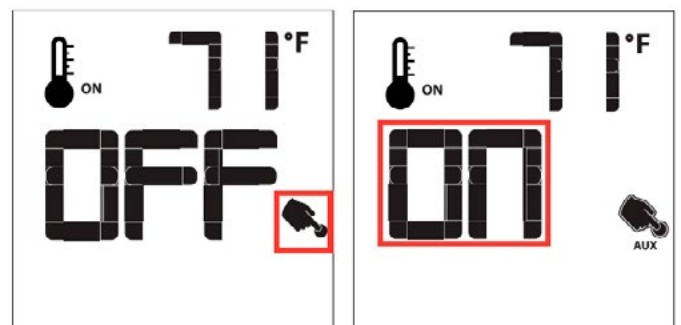

Figure 29.n Light Control

LED Remote Control Operation

Use AUX function to turn power on to LED

NOTE: The color being touched on the ring doesn't necessarily mean the same color will be displayed on the LED kit, keep moving along the wheel until the desired color is displayed

Montigo's Distinction series fireplaces have integrated LED lighting installed beneath the burner tray. The LEDs are controlled by the included remote. The fireplace burner does not need to be lit for the LEDs to function.

The LEDs can be set to any solid color using the color wheel on the remote control, or to any of the 20 patterns listed below. The speed and brightness of the various functions can also be adjusted by the remote.

LED Troubleshooting

The LEDs are pre-wired inside the control panel and fireplace; ensure that all wiring is connected before troubleshooting.

If the LEDs are lit but cannot be controlled by the remote, first change the remote's batteries.

If the remote still cannot control the LED lighting, you may need to pair the remote with the controller.

If the LEDs will not light, measure the voltage on the power supply's output (underneath burner tray), the output should be 24VDC.

If a portion of the LED strip displays a single color only, the LEDs must be replaced.

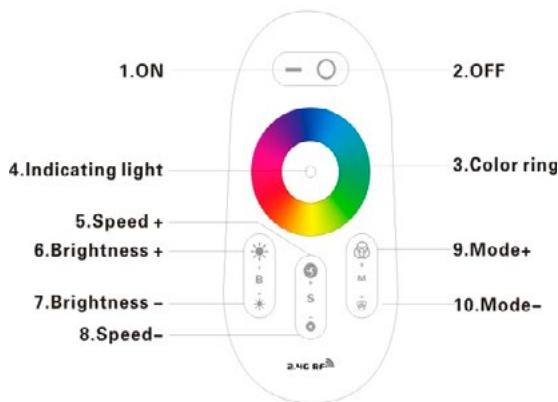

Figure 30. LED remote

#	Mode	Brightness State	Speed State
1	Static white color	Adjustable	Unadjustable
2	White color gradual changes	Adjustable	Adjustable
3	All colors gradual change	Adjustable	Adjustable
4	Red/green/ blue three colors gradual change	Adjustable	Adjustable
5	Seven colors jump to change	Adjustable	Adjustable
6	Three colors jump to change	Adjustable	Adjustable
7	Red/ green jumps to change	Adjustable	Adjustable
8	Red/blue jumps to change	Adjustable	Adjustable
9	Blue/green jumps to change	Adjustable	Adjustable
10	White color frequently blinks	Adjustable	Adjustable
11	White color glitters	Adjustable	Adjustable
12	Red color frequently blinks	Adjustable	Adjustable
13	Red color glitters	Adjustable	Adjustable
14	Green color frequently blinks	Adjustable	Adjustable
15	Green color glitters	Adjustable	Adjustable
16	Blue color frequently blinks	Adjustable	Adjustable
17	Blue color glitters	Adjustable	Adjustable
18	Yellow color frequently blinks	Adjustable	Adjustable
19	Yellow color glitters	Adjustable	Adjustable
20	Circulation mode		

Figure 30.c Remote modes

Item	Parameters
Working Voltage	AAA*2pcs(3V)
Radio Frequency	2400-2483.5MHz
Modulate Method	GFSK
Transmit Power	6db
Standby Power Consumption	10uA
Remote Distance	20-30m
Dimension	110×52×30mm

Figure 30.b Remote parameters

Pairing the Remote to the Module (Code Clearing and Code Matching)

Montigo ships the fireplace with a functional LED system, but, if you need to pair an alternate remote, follows these steps:

1. Switch off the power. Wait until power supply led indicator goes off.
2. Switch on again.

For Version 2.0 LED Remote (Indicating light on color wheel is opaque.):



Figure 30.d Remote version 2.0

3. Within 3 seconds (after power supply indicator goes on) press S+ button.
4. To clear a remote's pairing, follow the same procedure, but hold the remote's speed- button until the fireplace LEDs flash 9 times.

For Version 3.0 LED Remote (Indicating light on color wheel is dotted.):



Figure 30.d Remote version 3.0

3. Within 6 seconds (after power supply indicator goes on) press ON button and M- for two seconds.

NOTE:

One remote can control multiple fireplaces, but one fireplace can be paired with a maximum of 4 remotes.

NOTE:

If remote fails to pair with controller, remove batteries from remote and let it sit for 2 minutes (this way all residual power will be drained). Install batteries back and repeat pairing procedure.

Section 10: Cleaning and Maintenance

General

- Have the fireplace and installation inspected yearly. The inspection must include, but is not limited to, the following:
 - A visual check of the entire vent system and termination.
 - An inspection of the door gaskets to ensure a proper seal.
 - An inspection of the burner, vent run, and primary air openings.
 - An inspection of the gas valve, gas components, and pilot flame. For your convenience a 1/8" manifold pressure tap is supplied on the gas valve for a test gauge connection.
- Always keep the fireplace area clear and free of combustible materials, as well as gasoline and other flammable vapors and liquids.
- Do not use this appliance if any part has been under water. Immediately call a qualified service technician to inspect the appliance and to replace any part of the control system and any gas control which has been under water.

NOTICE

Do not use ammonia based or abrasive cleaners on the glass, they will permanently etch the surface. Use an approved gas fireplace glass cleaner such as Kel-Kem or White off.

Annual inspection list for determining safe operation of a direct vent gas fireplace

- 1) Inspect and operate the pressure relief mechanism to verify relief mechanisms are free from obstruction to operate.
- 2) Clean glass window with a suitable fireplace glass cleaner. Abrasive cleaners must not be used. Be careful not to scratch the glass when cleaning.
- 3) Inspect the operation of the flame safety system Pilot or Flame rectification device.
- 4) Inspect and ensure the lighting of the main burner occurs within 4 seconds of the main gas valve opening. Visual inspection should match that outlined in the appliance instruction manual. Inspect primary air openings for blockage.
- 5) Inspect condition of vent and vent terminal for sooting or obstruction and correct if present.
- 6) Vacuum and clean any debris in the firebox that is not supposed to be there.
- 7) Test and measure the flame failure response time of the flame safety system. It must de-energize the safety shutoff in no more than 30 seconds.
- 8) Check all accessible gas-carrying tubes, connections, pipes and other components for leaks.

Cleaning

When the fireplace is first activated, there may be some smoking and a visible film may be left on the glass. This is a normal condition, and is the result of burning of protective coatings on new metal.

- Glass must be cleaned periodically to remove any film (which is a normal by-product of combustion) which may be visible. Film can easily be removed by removing the door, as shown on Page 35. Handle the door carefully, and clean it with non-abrasive, non-ammonia based glass cleaners. One of the most effective products is Kel-Kem.
- During the initial firing, Silicone seals will "off gas", leaving a visual deposit of a white substance on combustion chamber walls. This can easily be removed using normal household products.
- Use a vacuum cleaner or whisk broom to keep the control compartment, burner, and firebox free from dust and lint.

Appendix A: Venting Terminations

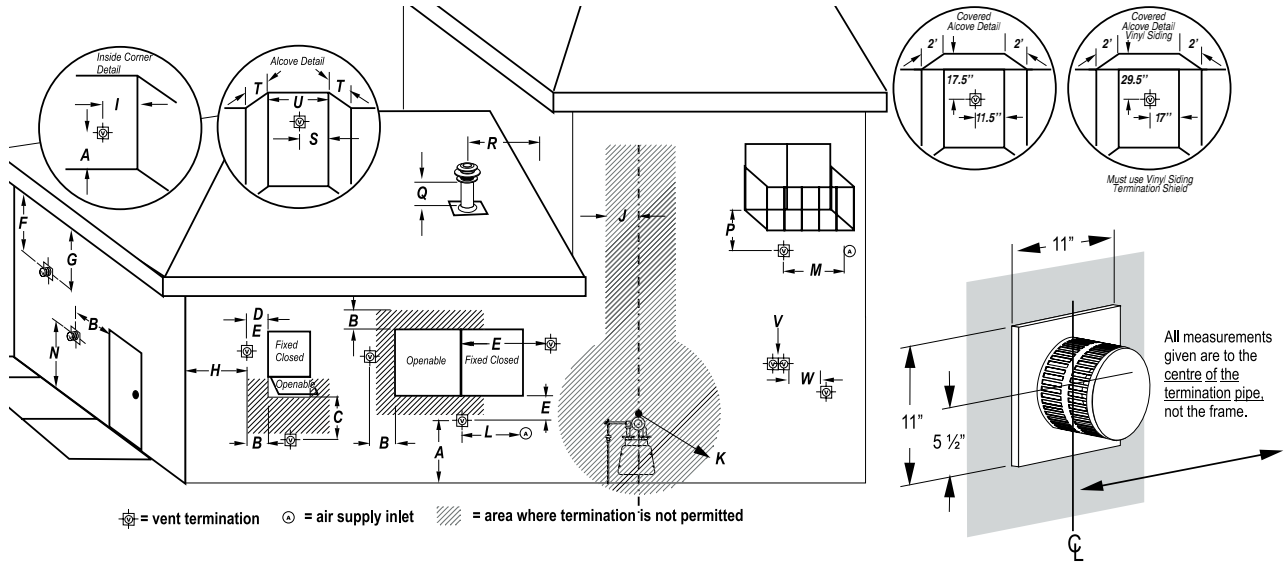

Location	Canada*	USA**
A clearance to the termination frame above grade, veranda, porch, deck, or balcony	12 inches	12 inches
B clearance to top of doors or operable windows	12 inches	12 inches
C clearance to sides or bottom of door or operable windows	12 inches	9 inches
D clearance to permanently closed window when installed with approved glass penetration termination	0	0
E clearance to permanently closed window Recommended to prevent condensation	16 inches	16 inches
F clearance to ventilated soffit located within a horizontal distance to 24 inches from centerline of termination	22 inches	22 inches
G clearance to unventilated soffit	30 inches to combustibles 16 inches to non-combustibles	30 inches to combustibles 16 inches to non-combustibles
H clearance to outside corner	9 inches	9 inches
I clearance to inside corner	12 inches	12 inches
J clearance to each side of the vertical centerline of a metre or regulatory assembly to a maximum vertical distance of 15ft	3 feet	3 feet
K clearance to service regulator vent outlet	3 feet	3 feet
L clearance to non mechanical air supply inlet to the building or combustion air inlet to other appliance for appliance <= 100,000 BTU/H (30 kW)	12 inches	12 inches
M clearance to forced air supply inlet	6 feet	3 feet above air inlet
N clearance above paved sidewalk or paved driveway located on public property	7 feet	7 feet
P clearance under veranda, porch, deck, or balcony	22 inches to combustibles 16 inches to non-combustibles	22 inches to combustibles 16 inches to non-combustibles
Q clearance above roof	2 feet	2 feet
R clearance to adjacent walls and neighboring buildings	2 feet	18 inches
S clearance from corner in recessed location	12 inches	12 inches
T Maximum depth of recessed location	4 feet	4 feet
U Maximum width for back wall of recessed location	2 feet	2 feet
V Horizontal clearance between two terminations that are level	0	0
W Horizontal clearance (centre to centre) between two terminations that are not level	18 inches	18 inches

Note 1: For N a vent shall not terminate directly above the sidewalk or paved driveway which is located between two single family dwellings and serve both dwelling.

Note 2: For P only permitted if veranda, porch, deck, or balcony is fully open on a minimum of two sides beneath the floor

Note 3: For J, K, and as specified in CGA B149 installation code. Local codes or regulations may vary.

* Based on CGA B149.1 Natural Gas and Propane installation code. Local codes may vary, please check with local regulatory agency.

** Based on ANSI Z223.1/NFPA 54 National Fuel Gas Code. Local codes may vary, please check with local regulatory agency.

Appendix B: Warranty

MONTIGO RESIDENTIAL WARRANTY PROGRAM

Canadian Heating Products Inc. and/or Montigo DelRay Corp (collectively referred to herein as "The Companies"), warrants the Montigo gas appliance (referred to herein as 'the appliance') to be free from defects in materials and workmanship at the time of manufacture. The gas appliance and related components are further subject to the terms and conditions set forth below.

This warranty covers the following Montigo product series: **Distinction, Divine & Divine Outdoor (H-Series), Illume (FID Inserts), Phenom (L/P/PL-Series), Exemplar (R/RP-Series), Mahana and DelRay**

Component	Coverage Period	Labor Coverage
Firebox, heat exchanger	15 years	1 year
Main burner	15 years	1 year
Gas control valve and related control components (pilot assembly, spark electrode flame sensors, thermopile)	1 year	1 year
Electrical components (internal blowers, ignition control module, wiring, switches, remote control systems, blower control module, accent bulbs)	1 year	1 year
Firebox media (logset, glass beads, river rocks)	1 year	1 year
Glass (thermal breakage)	1 year	1 year
Plated, painted finishes (including interior reflective glass) *	1 year	1 year
Refractory lining	1 year	1 year
Mesh/Glass safety barriers	1 year	1 year
Power vent termination	1 year	1 year
Montigo terminations*	10 years	1 year
Montigo venting (excluding termination)	15 years	1 year

* *Exterior painted surfaces exempt*

QUALIFICATIONS TO THE WARRANTY

This Warranty only covers gas appliances installed in the United States or Canada.

To receive the benefits of this warranty, the appliance must be purchased, installed and serviced annually by a dealer authorized by The Companies for the warranty to be valid.

The gas appliance must be installed by a licensed professional in accordance with The Companies' installation instructions and local building codes. The warranty on the appliance covers only components manufactured by The Companies. The use of components manufactured or supplied by other manufacturers and used in conjunction with the appliance could create serious safety hazards, may result in the denial of certification by recognized national safety agencies and could violate local building codes. Such use may untimely void this warranty. This warranty does not cover any damages occurring from the use of any components not manufactured or supplied by The Companies.

The appliance must be subjected to normal use. The appliance is designed to burn natural gas (NG) or liquefied petroleum (LP) only. Burning conventional fireplace fuels such as wood, coal or any other solid fuel will cause damage to the appliance, produce

excessive temperatures will result in a fire hazard and void all warranties. This warranty is transferable. The appliance must remain in its original place of installation to be valid.

If the components of the appliance covered by this warranty are found to be defective within the time frame stated (see The Companies investigation of claims), The Companies will, at its option, replace or repair defective components of the appliance manufactured by The Companies at no charge and will also pay for labor costs (in accordance with schedule) incurred in replacing or repairing components. If repair or replacement is not commercially practical, The Companies will, at its sole discretion, fully discharge all obligations under the warranty by refunding the verified dealer purchase price of the appliance, excluding the cost of labor unless the labor is covered by the terms of the warranty.

This warranty covers only parts and labor as provided above. In no case shall the companies be responsible for materials, components or construction, which are not manufactured or supplied by The Companies, or for the labor necessary to install, repair or remove such materials, components or construction. All replacement or repair components will be shipped F.O.B. from the nearest Company factory.

LIMITATION ON LIABILITY

It is agreed and understood that The Companies sole obligation, and purchaser's exclusive remedy under this warranty, under any other warranty, expressed or implied, or in contract, tort or otherwise, shall be limited to repair, replacement or refund as specified above. The opinion of The Companies with respect to these matters shall be final.

In no event shall The Companies be responsible for any incidental or consequential damages caused by (but not limited to) improper installation, installation by an unqualified or unauthorized installer, accident, lack of regular maintenance, user error, abuse, misuse, Acts of God, power surges, floods, natural disasters, force majeure, defects in its appliance whether such damage occurs or is discovered before or after replacement or repair, and whether or not such damage is caused by The Companies negligence. Some jurisdictions do not allow the exclusion or limitation of incidental or consequential damages, so the above limitation or exclusion may not apply to you. The duration of any implied warranty with respect to the appliance is limited to the duration of the foregoing warranty. Some jurisdictions do not allow limitations on how long an implied warranty lasts, so the above limitation or exclusion may not apply to you.

Appendix B: Warranty Continued

EXCLUSIONS TO WARRANTY

Corrosion or rust of any kind due to a lack of maintenance, inadequate combustion air or improper venting and corrosive chemicals/environments, expansion and contraction of metals or minor movements of components causing noise are not covered by this warranty.

Willful misconduct (i.e. use of the appliance with problems known to the purchaser and causing further damages), including unauthorized or self-performed 'fixing' or exploration of the appliance's internal workings will void the warranty.

Appliances on which the serial number has been altered, defaced, removed or made illegible will void the warranty.

Costs incurred for diagnosis, service work, shipping and handling of defective or replacement parts are not covered under this warranty.

The published warranties are not applicable for any equipment manufactured by The Companies that has been sold direct to the consumer via internet or auction websites. The Companies do not endorse, approve or certify any online sale of its products through auction websites, online retailers or any other method of online sales direct to consumers.

INVESTIGATION OF CLAIMS AGAINST WARRANTY

The Companies reserve the right to investigate any and all claims against this warranty and decide upon method of settlement.

The Companies are not responsible for work done without written consent of The Companies.

The Companies shall in no event be responsible for any warranty work done without first obtaining the Companies written consent.

The Companies employees and dealers have no authority to make any warranties to neither alter this warranty nor authorize any remedies in addition to or inconsistent with those stated within this warranty.

IF WARRANTY SERVICE IS NEEDED

To make a claim under this warranty, contact your installing dealer or contractor. The installing dealer is responsible for providing service and will contact the companies to initiate warranted parts replacements. In the event the installing dealer is unavailable, contact your nearest authorized Montigo dealer (www.Montigo.com) or contact Montigo direct at techsupport@montigo.com. Ensure you have your sales receipt and the model and serial number of your appliance.

DO NOT ATTEMPT TO DO ANY SERVICE WORK YOURSELF

If you cannot locate the installing dealer, or nearest dealer/distributor, you must notify The Companies in writing.

USA Offices

6955 Salashan Parkway
Ferndale WA, 98248
techsupport@montigo.com

Canadian Offices

27342 Gloucester Way
Langley, BC V4W 4A1
techsupport@montigo.com

The terms and conditions of this warranty may be altered or amended from time to time without prior notice.

WARRANTY PERIOD: Warranty coverage begins on the date of original purchase. In the case of new construction, warranty coverage begins on the date of first occupancy of the dwelling or six months after the sale of the product by an independent, authorized Company dealer/ distributor, whichever occurs earlier.

Appendix C: Amendment

(Gas Fireplace / Equipment sold in the State of Massachusetts) 5.08: Modifications to NFPA-54, Chapter 10

- (1) Revise NFPA-54 section 10.5.4.2 by adding a second exception as follows:

Existing chimneys shall be permitted to have their use continued when a gas conversion burner is installed, and shall be equipped with a manually reset device that will automatically shut off the gas to the burner in the event of a sustained back-draft.

- (2) Revise 10.8.3 by adding the following additional requirements:

- (a) For all side wall horizontally vented gas fueled equipment installed in every dwelling, building or structure used in whole or in part for residential purposes, including those owned or operated by the Commonwealth and where the side wall exhaust vent termination is less than seven (7) feet above finished grade in the area of the venting, including but not limited to decks and porches, the following requirements shall be satisfied:

1. **INSTALLATION OF CARBON MONOXIDE DETECTORS.** At the time of installation of the side wall horizontal vented gas fueled equipment, the installing plumber or gas fitter shall observe that a hard wired carbon monoxide detector with an alarm and battery back-up is installed on the floor level where the gas equipment is to be installed. In addition, the installing plumber or gas fitter shall observe that a battery operated or hard wired carbon monoxide detector with an alarm is installed on each additional level of the dwelling, building or structure served by the side wall horizontal vented gas fueled equipment. It shall be the responsibility of the property owner to secure the services of qualified licensed professionals for the installation of hard wired carbon monoxide detectors
 - a. In the event that the side wall horizontally vented gas fueled equipment is installed in a crawl space or an attic, the hard wired carbon monoxide detector with alarm and battery back-up may be installed on the next adjacent floor level.
 - b. In the event that the requirements of this subdivision can not be met at the time of completion of installation, the owner shall have a period of thirty (30) days to comply with the above requirements; provided, however, that during said thirty (30) day period, a battery operated carbon monoxide detector with an alarm shall be installed.
2. **APPROVED CARBON MONOXIDE DETECTORS.** Each carbon monoxide detector as required in accordance with the above provisions shall comply with NFPA 720 and be ANSI/UL 2042 listed and IAS certified.
3. **SIGNAGE.** A metal or plastic identification plate shall be permanently mounted to the exterior of the building at a minimum height of eight (8) feet above grade directly in line with the exhaust vent terminal for the horizontally vented gas fueled heating appliance or equipment. The sign shall read, in print size no less than one-half (1/2) inch in size, "GAS VENT DIRECTLY BELOW. KEEP CLEAR OF ALL OBSTRUCTIONS".

4. **INSPECTION.** The state or local gas inspector of the side wall horizontally vented gas fueled equipment shall not approve the installation unless, upon inspection, the inspector observes carbon monoxide detectors and signage installed in accordance with the provisions of 248 CMR 5.08(2)(a)1 through 4.

- (b) **EXEMPTIONS:** The following equipment is exempt from 248 CMR 5.08(2)(a)1 through 4:

1. The equipment listed in Chapter 10 entitled "Equipment Not Required To Be Vented" in the most current edition of NFPA 54 as adopted by the Board; and
 2. Product Approved side wall horizontally vented gas fueled equipment installed in a room or structure separate from the dwelling, building or structure used in whole or in part for residential purposes.
- (c) **MANUFACTURER REQUIREMENTS - GAS EQUIPMENT VENTING SYSTEM PROVIDED.** When the manufacturer of Product Approved side wall horizontally vented gas equipment provides a venting system design or venting system components with the equipment, the instructions provided by the manufacturer for installation of the equipment and the venting system shall include:
1. Detailed instructions for the installation of the venting system design or the venting system components; and
 2. A complete parts list for the venting system design or venting system.
- (d) **MANUFACTURER REQUIREMENTS - GAS EQUIPMENT VENTING SYSTEM NOT PROVIDED.** When the manufacturer of a Product Approved side wall horizontally vented gas fueled equipment does not provide the parts for venting the flue gases, but identifies "special venting systems", the following requirements shall be satisfied by the manufacturer:
1. The referenced "special venting system" instructions shall be included with the appliance or equipment installation instructions; and
 2. The "special venting systems" shall be Product Approved by the Board, and the instructions for that system shall include a parts list and detailed installation instructions.
- (e) A copy of all installation instructions for all Product Approved side wall horizontally vented gas fueled equipment, all venting instructions, all parts lists for venting instructions, and/or all venting design instructions shall remain with the appliance or equipment at the completion of the installation.
- (3) After NFPA-54 section 10.10.4.2 add a new section 10.10.4.3 as follows:
- When more than four gas appliances are to be vented through a common gas vent or common horizontal vent manifold, a plan of the proposed vent installation shall be submitted to the Inspector and the serving gas supplier for review and approval.

Extraction from: Massachusetts Rules and Regulations

5.00: Amendments To 2002 Edition Of ANSI Z223.1-NFPA-54

Indoor fireplace in protected outdoor applications

This fireplace may be installed into outdoor locations provided they are suitably protected from direct water impingement. However, all installation clearances in the appliance manual must be observed. Framing, Clearances to Combustibles, Mantel Heights, Facing Requirements, Venting Installation, etc. Use supplied Safety Screen.

Dimension "A"	X .75	= min. overhang depth
The overhang must extend at least 75% of the roof line height (A) Height is measured from bottom of fireplace opening to the ceiling		

Example formula
Min. overhang = A x 0.75
For example: if distance A is 84", the overhang must extend at least 63"

See through fireplace

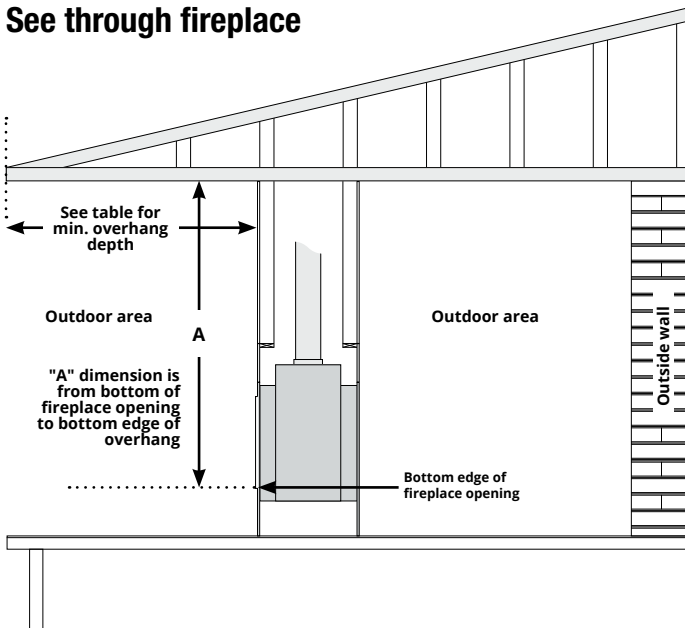

Single sided fireplace

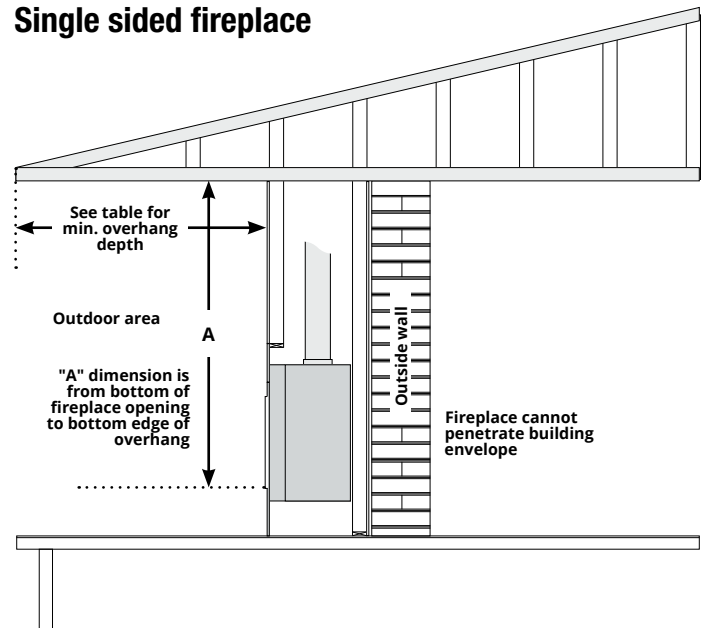

Notes

- Overhang requirements must be applied to both the front and sides of the fireplace
- Indoor see-through models cannot be installed as indoor/outdoor fireplaces, as air flows through both sides of the fireplace.
- If the fireplace will be in contact with salt water, then an outdoor fireplace is recommended
- Follow all building codes, including those addressing fireplace penetration of an exterior building envelope
- Follow all product installation instructions; including framing, clearances to combustibles, mantel heights, Facing Requirements, venting installation, etc. Use supplied safety screen.
- All wiring connections to line power shall be in accordance with outdoor requirements of; NECA NFPA 70 in the USA Canadian Electrical Code, CSA C22.1 for Canada.
- The Fireplace is not to be operated in temperatures below freezing (0°C | 32°F)

NOTICE

Units with tempered glass doors are vulnerable to rapid and/or extreme changes in temperature (thermal shock). Take care to prevent water from contacting the fireplace, especially if it is hot.

D6315 DL6315

Vented gas fireplace heater