



C34 FIREPLACE

Installation Reference Guide

REFER TO OWNER'S MANUAL FOR SPECIFIC INSTALLATION REQUIREMENTS AND ADDITIONAL PRODUCT INSTRUCTIONS

Minimum Framing Dimensions

Depth	20"	508 mm
Width	45"	1143 mm
Header Height	38"	965 mm
Enclosure Ceiling	65"	1651 mm

1" (25mm)
Clearance from
framing studs
to venting

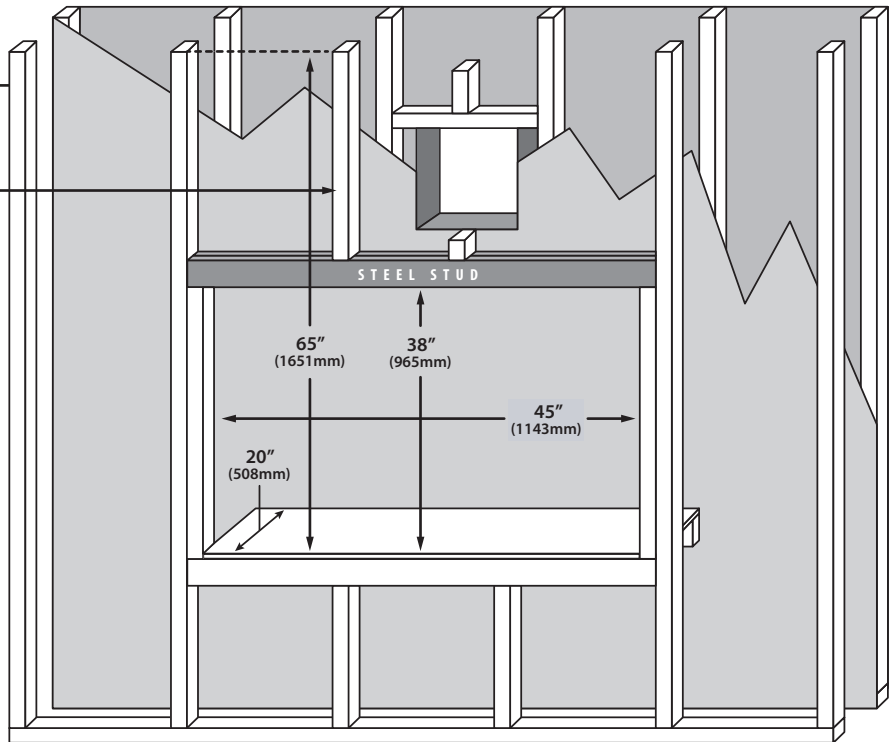

Note: Vent size 5/8

Clearance to Combustibles

A - Finishing edge to side wall	7"	229mm
B - Minimum clearance to enclosure ceiling	65"	1651 mm
C - Minimum clearance to mantel height	See Chart	See Chart
D - Front of door to edge of floor protection	0"	0 mm
E - Minimum alcove width	50"	1270 mm

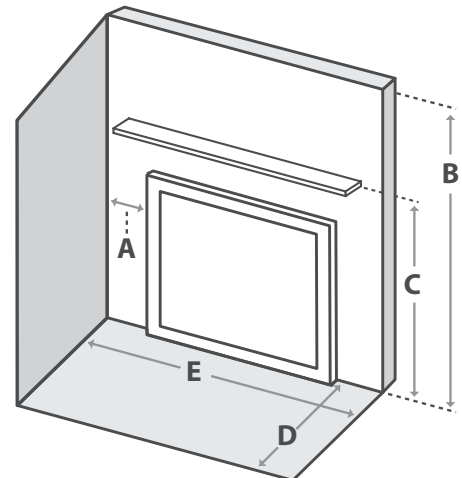

Non-Combustible Board Placement

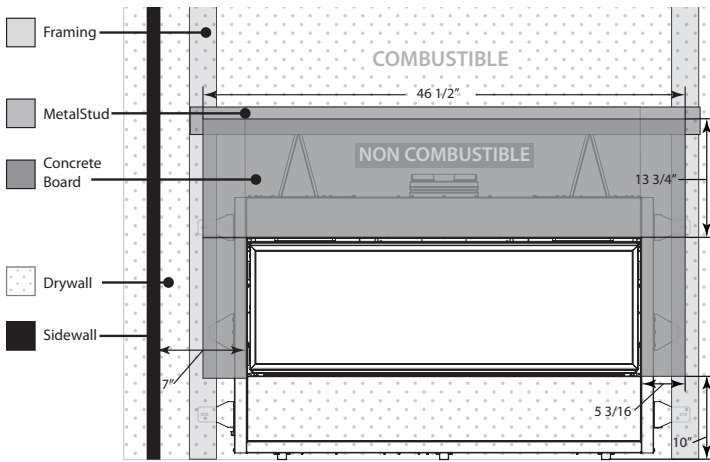

Minimum Venting Requirements

Minimum venting is shown in figure 20. the framing height to the center of the thimble is 50". Minimum venting must include a 12" vertical section and a 90 degree elbow which is then terminated horizontally. For a vertical termination please follow the vent pipe manufacturer's installation instructions for vertical vent termination framing. A minimum of 1 in. (25 mm) clearance on all sides of the vertical vent pipe must be maintained. For every 12" of horizontal run there must be a 1/4" of rise. 1" of clearance between framing and venting must be maintained at all times. 2" above the venting and 3" above an elbow.

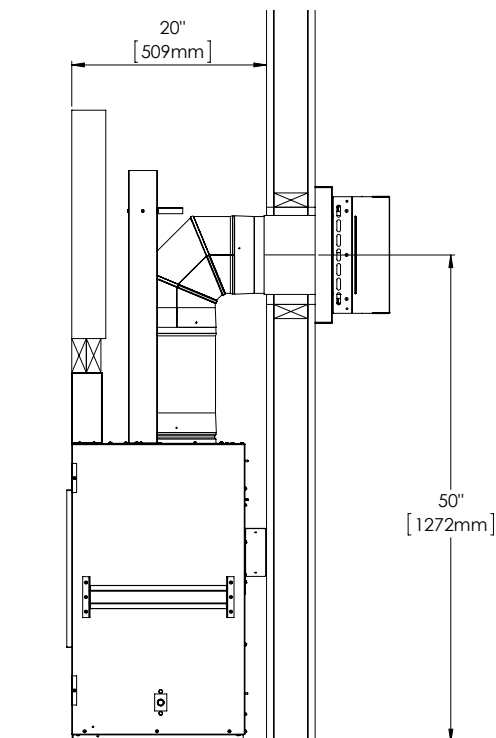

Fireplace Dimensions

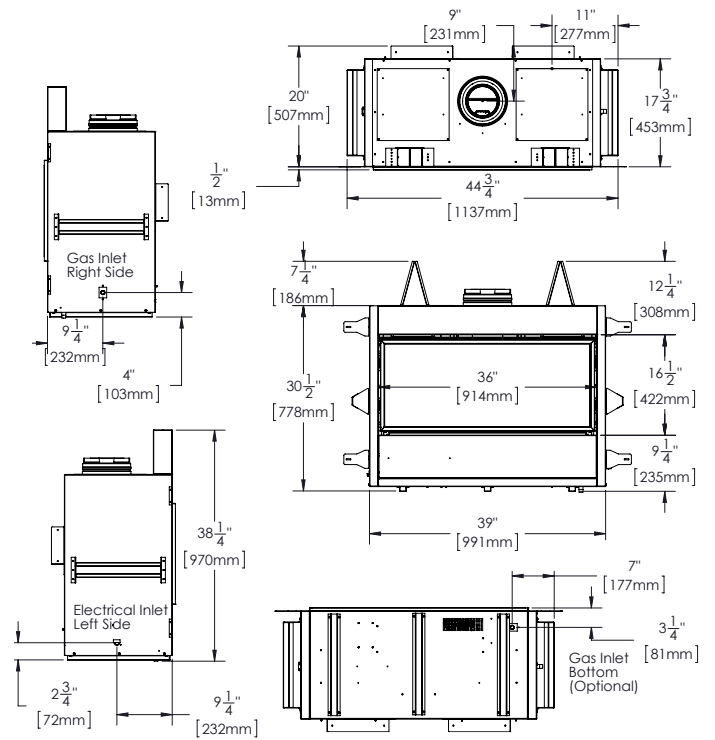

Mantel Projections

Mantel graph dimensions are measured from the bottom of the fireplace, if you wish to reference the mantel height from the tiling edge subtract 15 inches (381mm) from the mantel height depicted on the graph. If you plan to install a TV above your fireplace refer to the appropriate section of the owner's manual for available options. It is acceptable to install a combustible mantel over top of the non-combustible board. **If you are activating the Cool Surface System you are eligible to subtract 12" (305mm) from the mantel height shown in this diagram.**

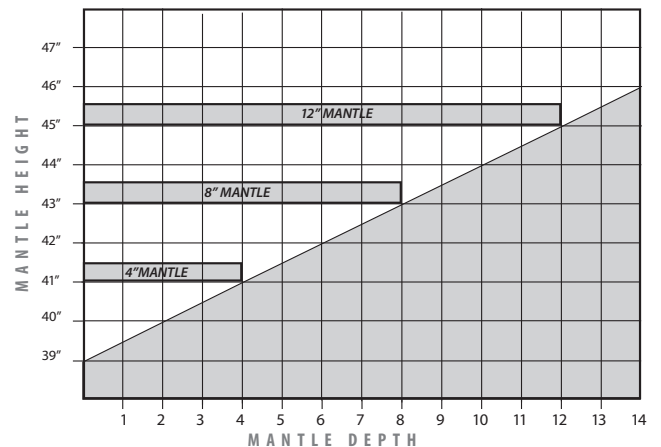

OPTIONAL STEP Cool Surface System Part 1

Dimensions

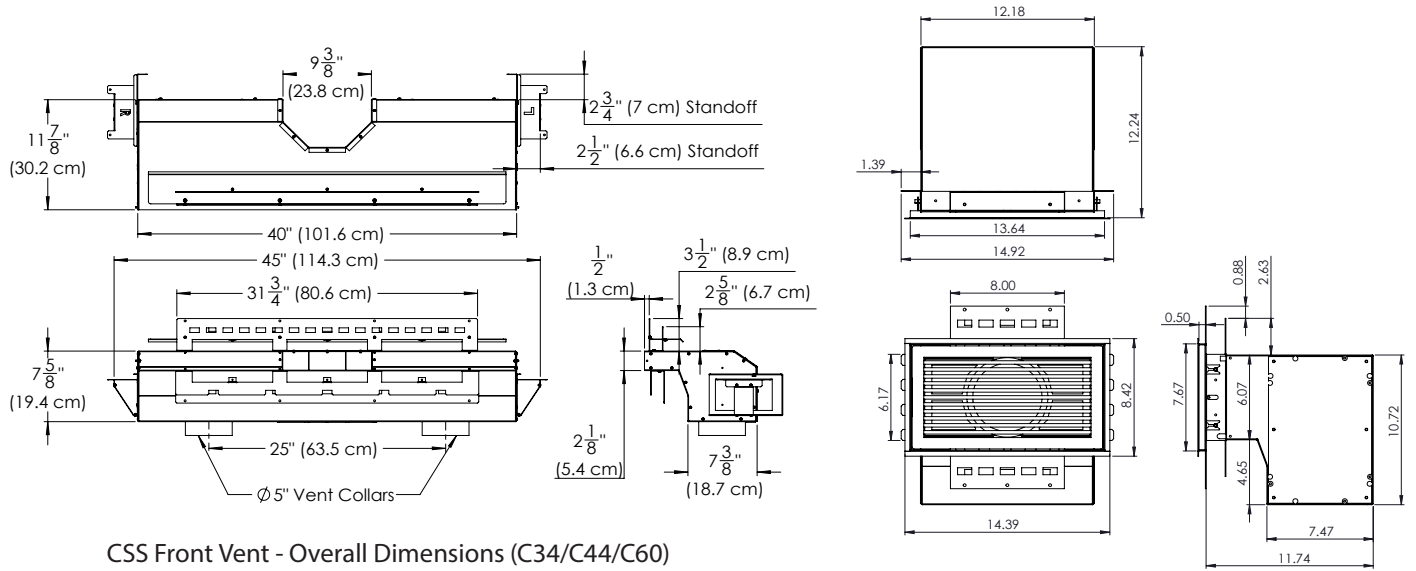

CSS Front Vent - Overall Dimensions (C34/C44/C60)

CSS Side Vent - Dimensions

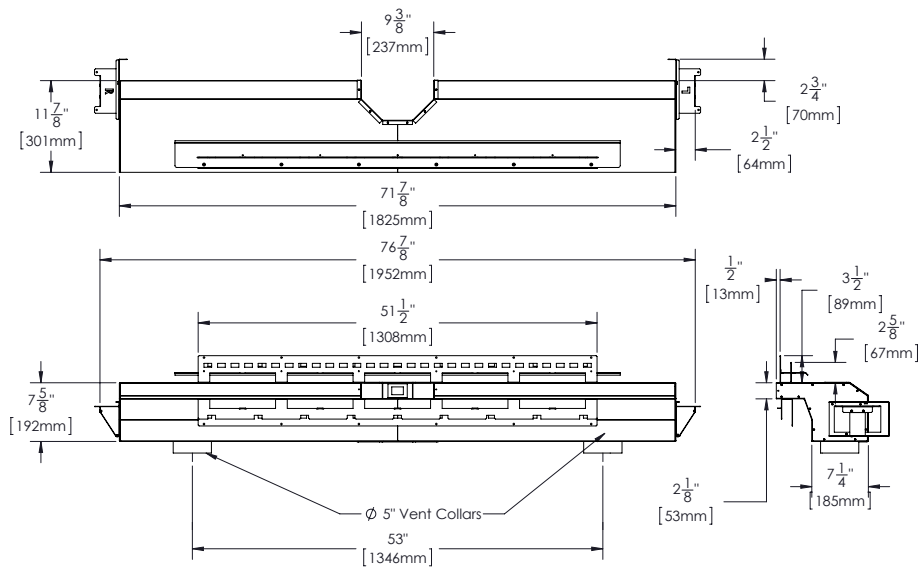

Figure 4. Cool Surface System Front Vent - Overall Dimensions (C72)

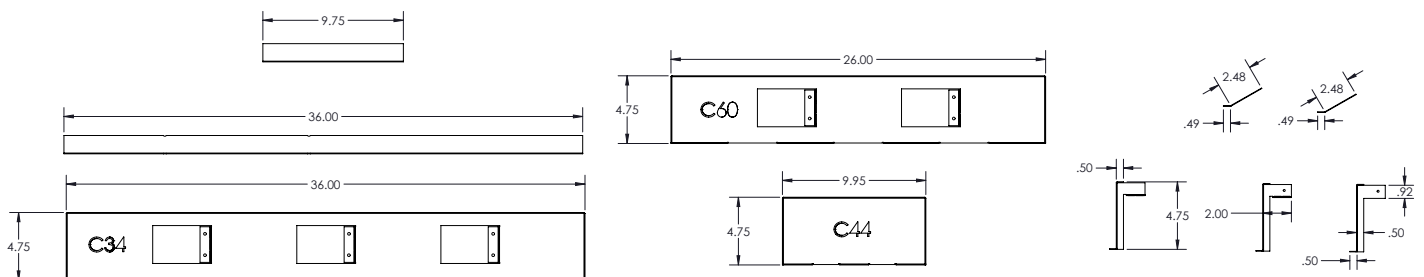
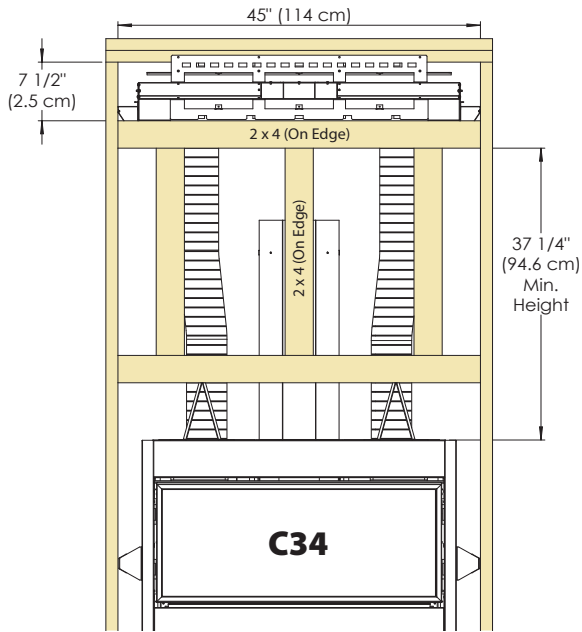

Figure 5. Cool Surface System Combustible Facing Kit Dimensions

OPTIONAL STEP Cool Surface System Part 2

Framing & Rough Opening – Front Vent

CSS Outlet Min. Top and Bottom standoff = 2 5/8" (6.7 cm) *All C Series*



CSS Outlet Min. Top and Bottom standoff = 2 5/8" (6.7 cm) *All C Series*

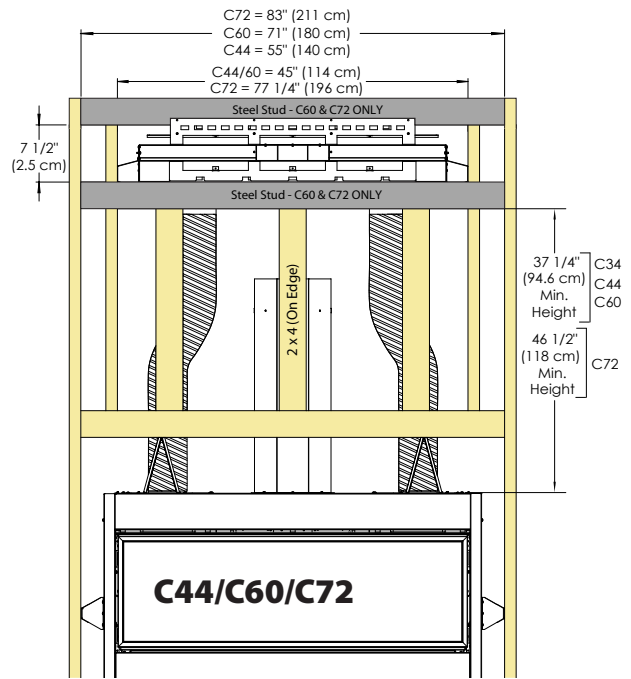

Framing & Rough Opening – Side Vent

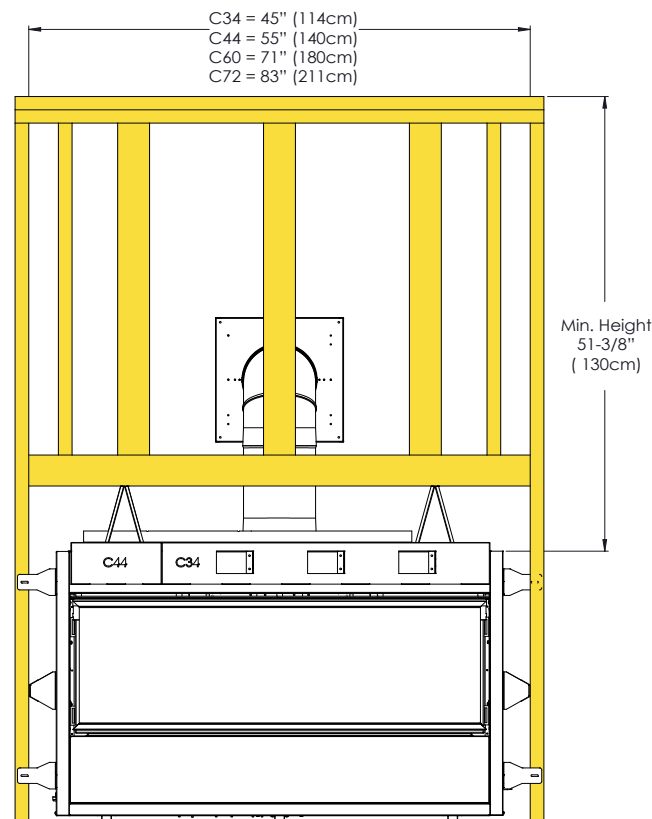

Revised Mantel Requirements:

Note: Minimum height of mantel if you intend on using a surround is 31"

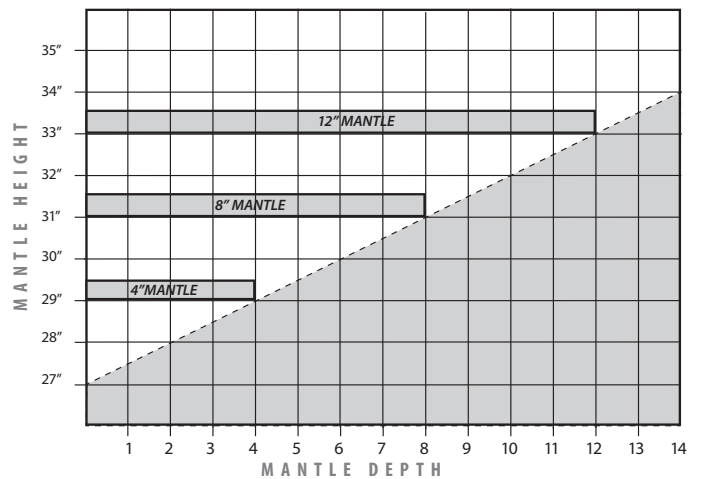

OPTIONAL STEP Cool Surface System Part 3

Venting Clearances - Front Vent

Shown here are the minimum framing and clearances for the CSS when the fireplace is installed with the minimum allowable vent length:

- Min. Ceiling Clearance from top of CSS outlet = 4" (10.2 cm)
- Min. Ceiling Clearance in wall from top of CSS Body = 5⁵/₈" (14.3 cm)
- CSS Body Min. Rear standoff = 2³/₄" (69.8 cm)

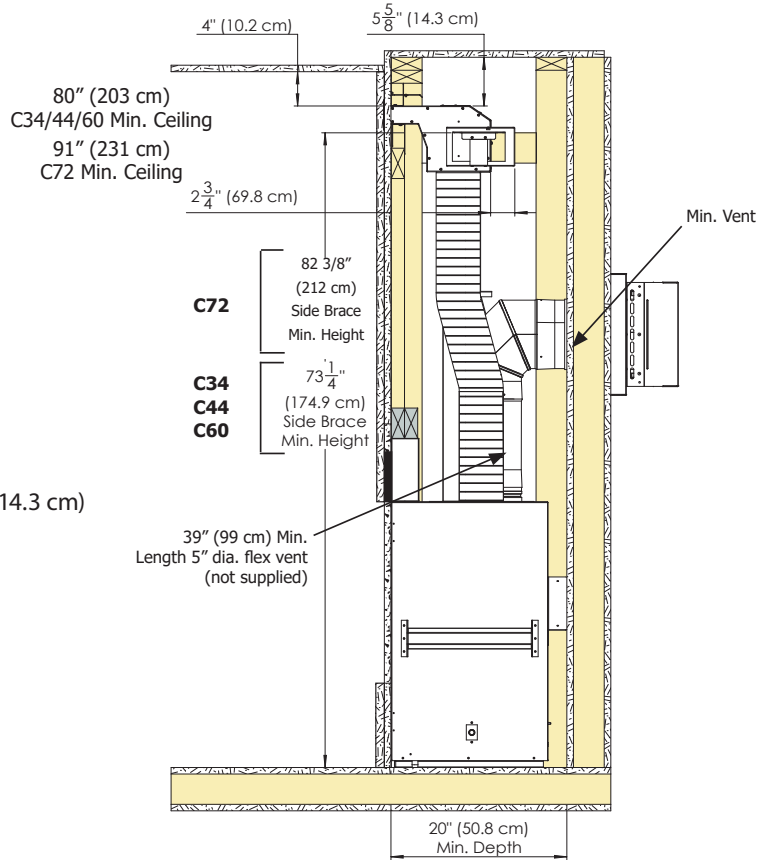

Venting Clearances – Side Vent

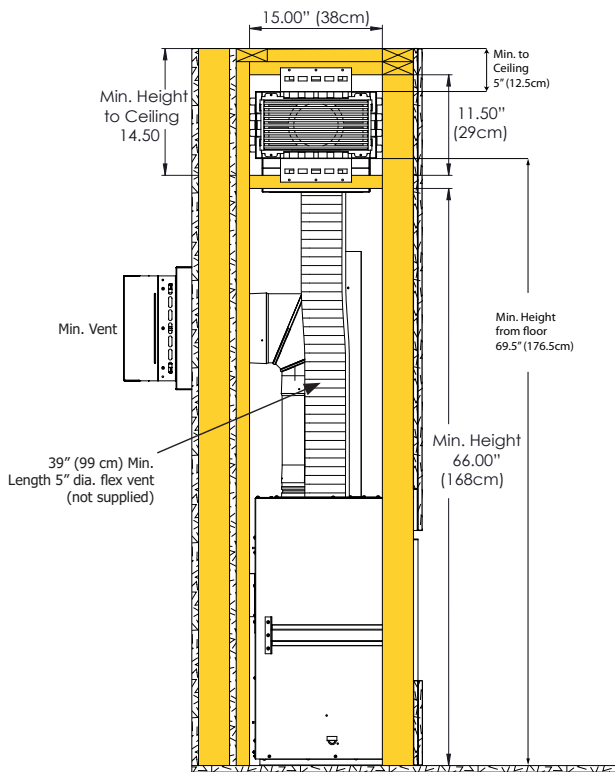

CSS Horizontal Vent - Min. Framing & Clearances

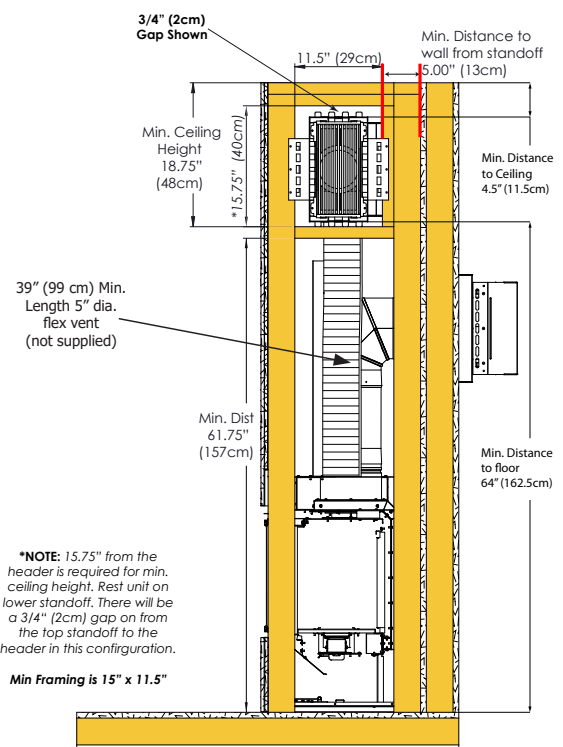

CSS Vertical Vent - Min. Framing & Clearances

OPTIONAL STEP Cool Surface System Part 4

Framing Clearances - Front Vent

Framing Clearances - Side Vent

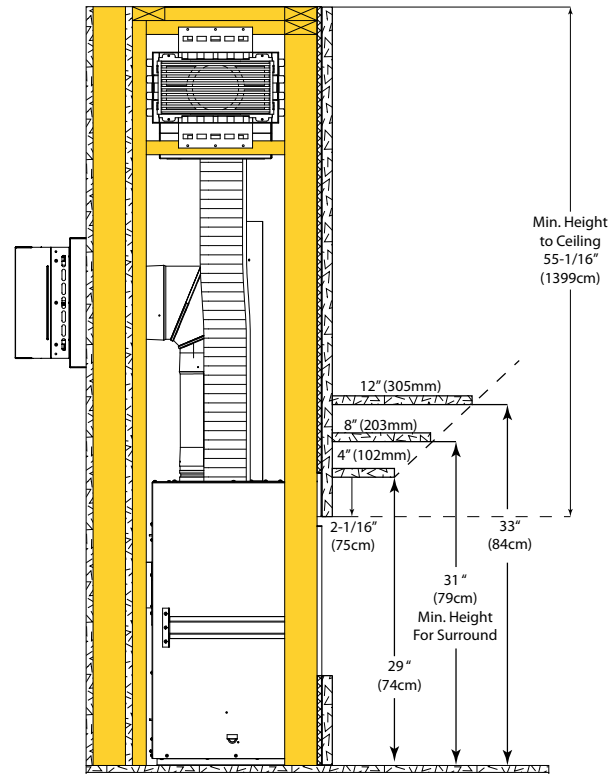
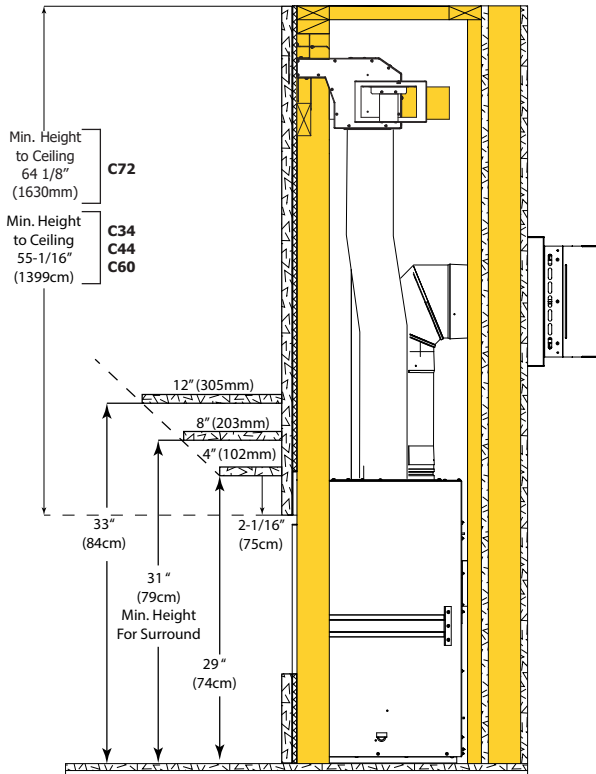

TV Installation Considerations:

If you are planning to mount a TV above your fireplace some considerations must be made to ensure it is protected from the heat.

During testing temperatures did not exceed 121°F (49°C) midway up the front wall (Figure 12 & 13). There is no guarantee that these temperatures will not harm the longevity of your TV. Make sure to consult your TV manufacturer's specifications to find the maximum allowable operating temperature. Since every home and installation is unique, temperatures should be verified at the time of install if possible. If desired, front wall temperatures can be lowered to 104°F (40°C) with the use of a mantle (Figure 13). Refer to page 7 for revised mantle clearances. A TV should not be installed if temperatures exceed the manufacturers maximum allowable temperature.

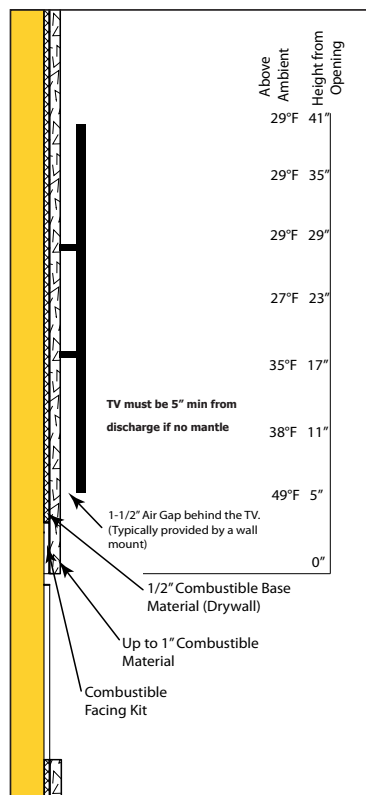

Figure 12 - CSS - TV Clearances

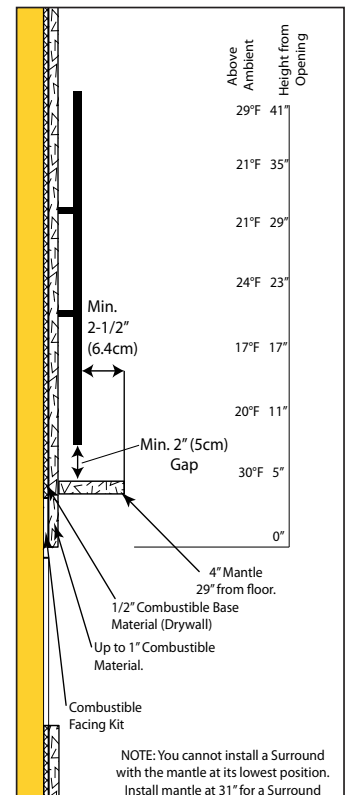

Figure 13 - CSS - TV Clearances