

Fireplace Dimensions

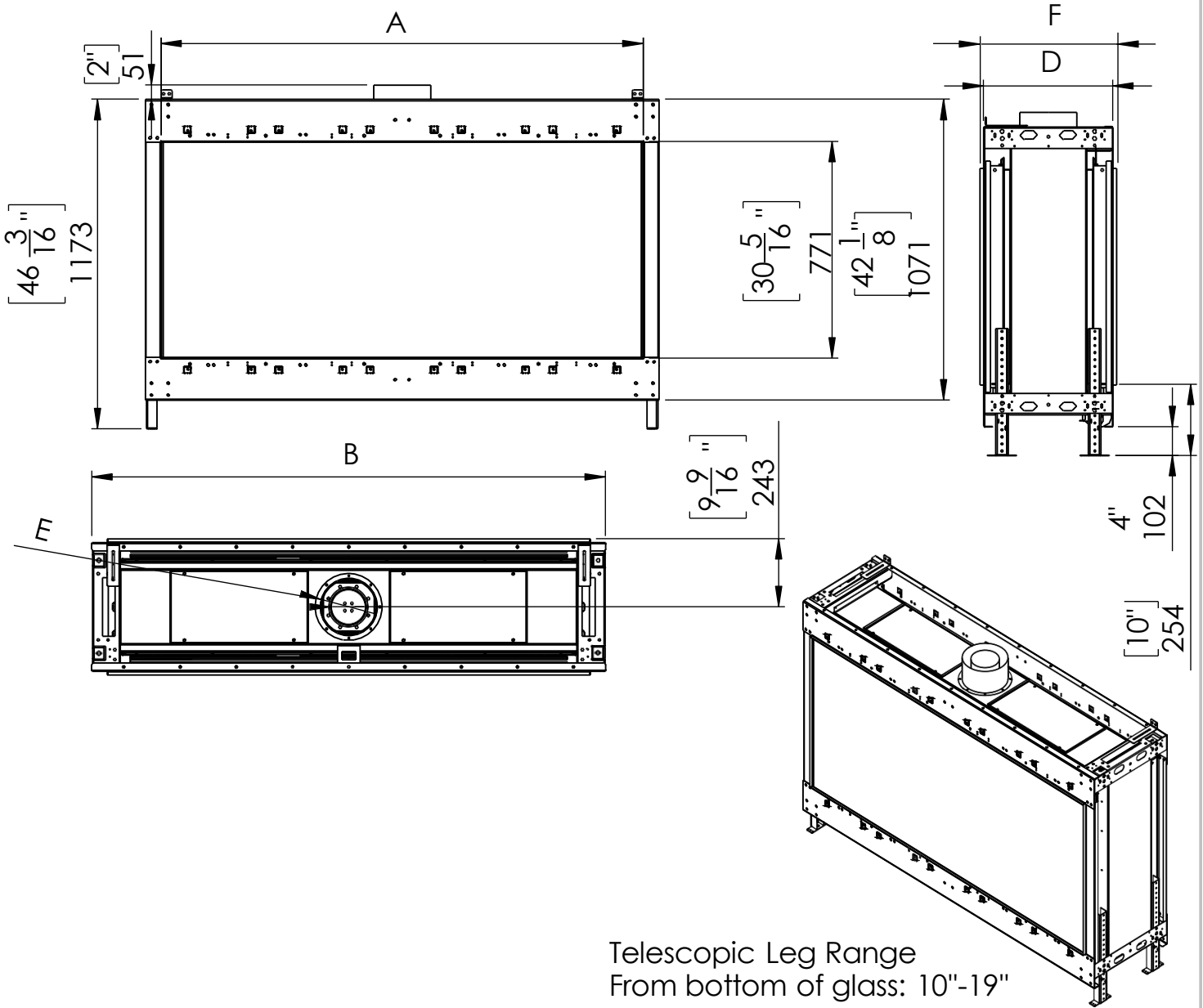

Model	45	50	60	70	80	100
A- Inch	45 $\frac{9}{16}$	52 $\frac{5}{16}$	62 $\frac{2}{16}$	72 $\frac{3}{16}$	84 $\frac{9}{16}$	101 $\frac{8}{16}$
B- Inch	41 $\frac{5}{16}$	48	57 $\frac{13}{16}$	67 $\frac{11}{16}$	80 $\frac{1}{16}$	97 $\frac{3}{16}$
F- Inch	19 $\frac{2}{16}$	19 $\frac{2}{16}$	19 $\frac{2}{16}$	19 $\frac{2}{16}$	19 $\frac{2}{16}$	19 $\frac{2}{16}$
D- Inch	18 $\frac{1}{16}$	18 $\frac{1}{16}$	18 $\frac{1}{16}$	18 $\frac{1}{16}$	18 $\frac{1}{16}$	18 $\frac{1}{16}$
E- Inch	4x6	5x8	5x8	5x8	5x8	5x8

Clearances below are to non-combustible materials.

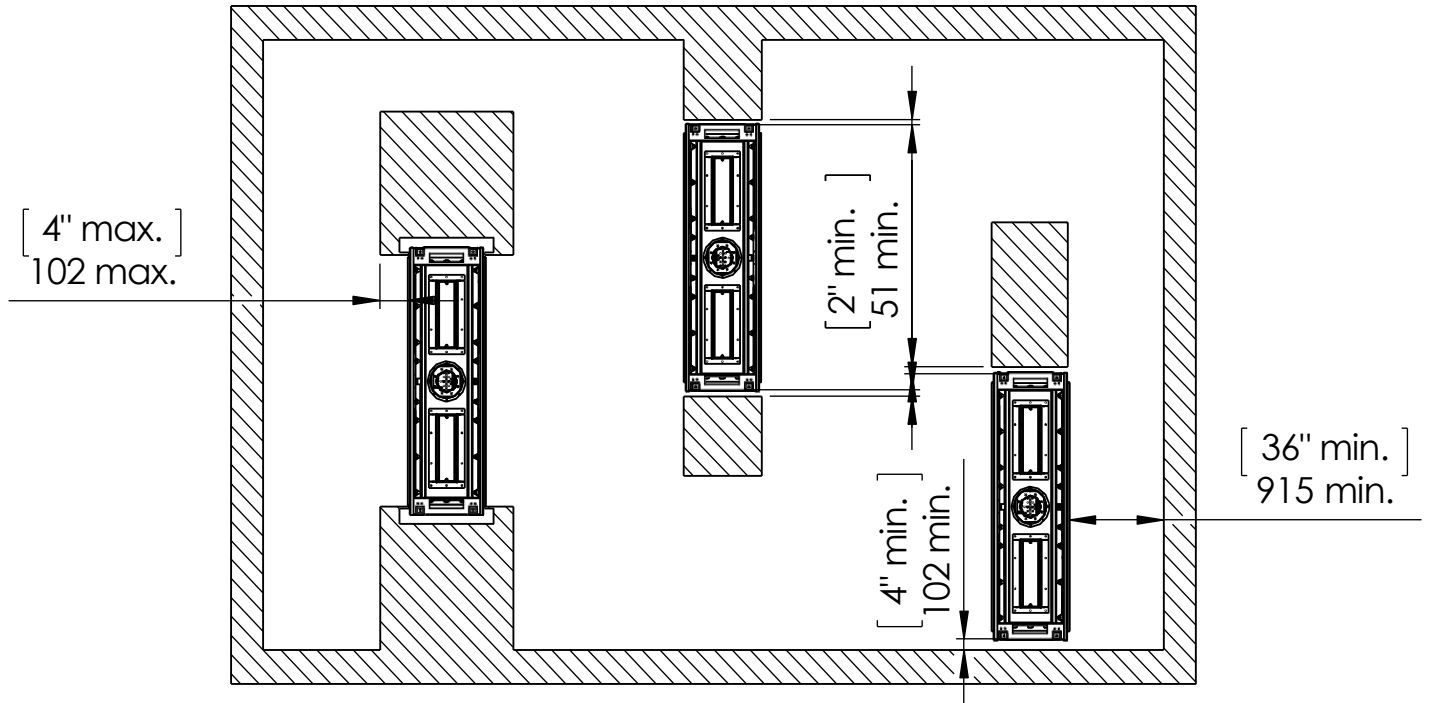

Chimney Installation

Horizontal Termination

For 5 x 8 vent size create 10" x 12" vent termination opening

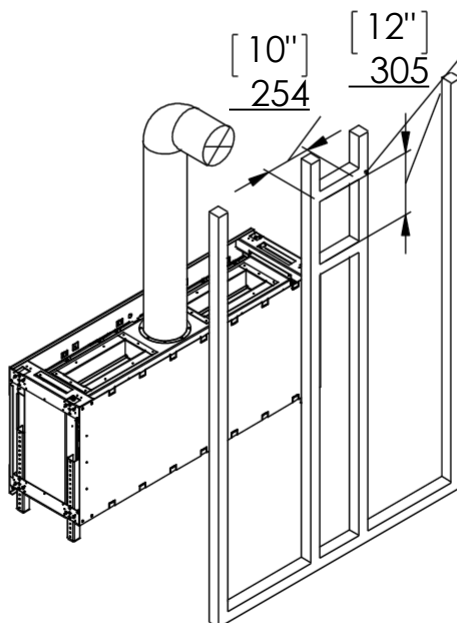

Vertical Termination

For 5 x 8 vent size create 10" x 10" vent termination opening

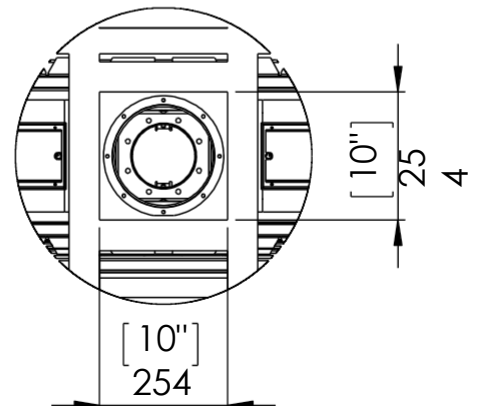
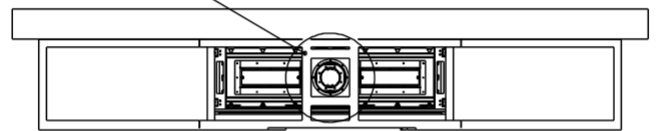

Flat Installation Example

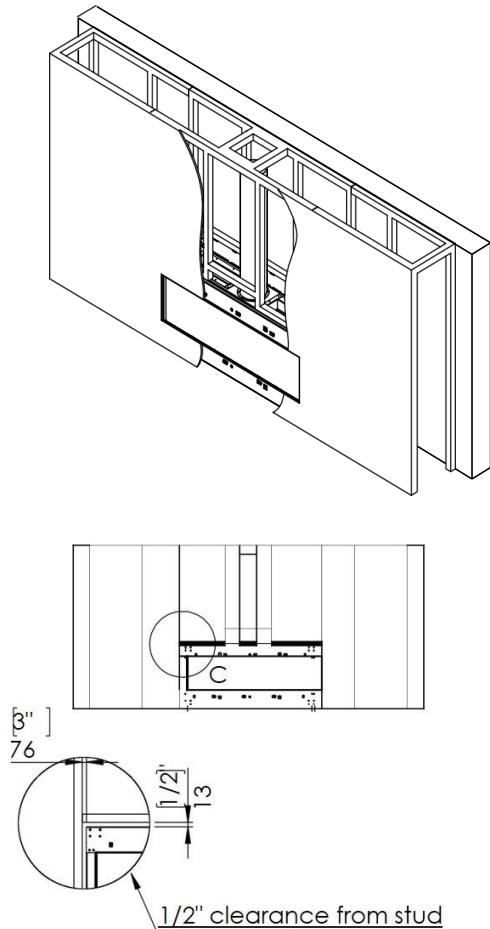

L Shape Installation Example

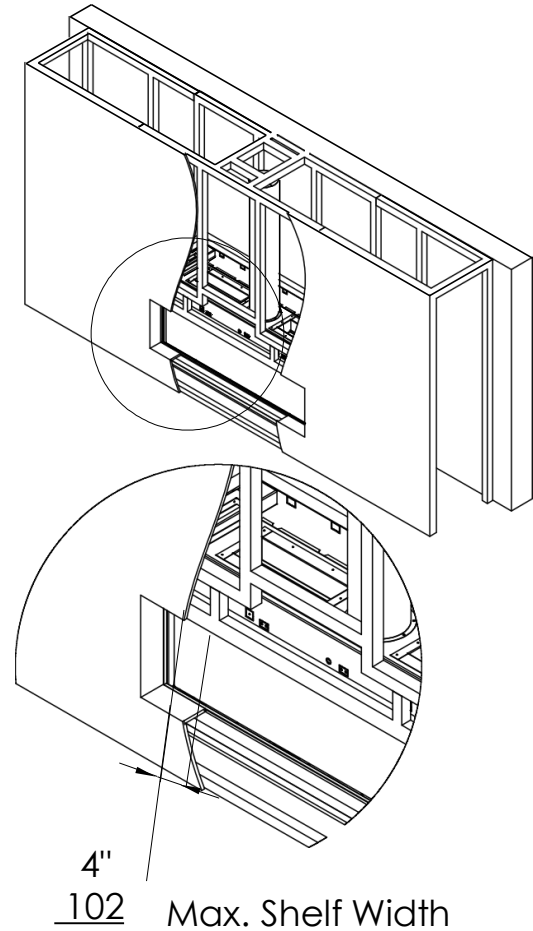

Heat Release and Air Intakes

The following sizes MUST be maintained for the upper heat release:

For fireplaces sized 80" & 100" – vent area must be at least 200 square inches.

For fireplaces sized 60" & 70" - vent area must be at least 140 square inches.

For fireplace sized 50" and below - vent area must be at least 100 square inches.

The following sizes MUST be maintained for the lower air intake:

For fireplaces sized 80" & 100" – vent area must be at least 100 square inches.

For fireplaces sized 60" & 70" - vent area must be at least 70 square inches.

For fireplaces sized 50" and below - vent area must be at least 50 square inches.

For See Through and Room Definer fireplaces, the air intake requirements are double.

NOTE: Openings above for Heat Release and Air Intake are measured for open air space.

NOTE: On all See Through and Room Definer units the air intake must be doubled

Top Shadow Line

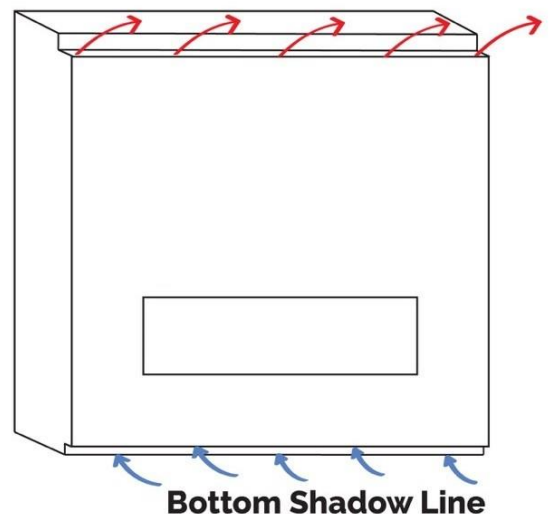

Wood Framing Dimensions

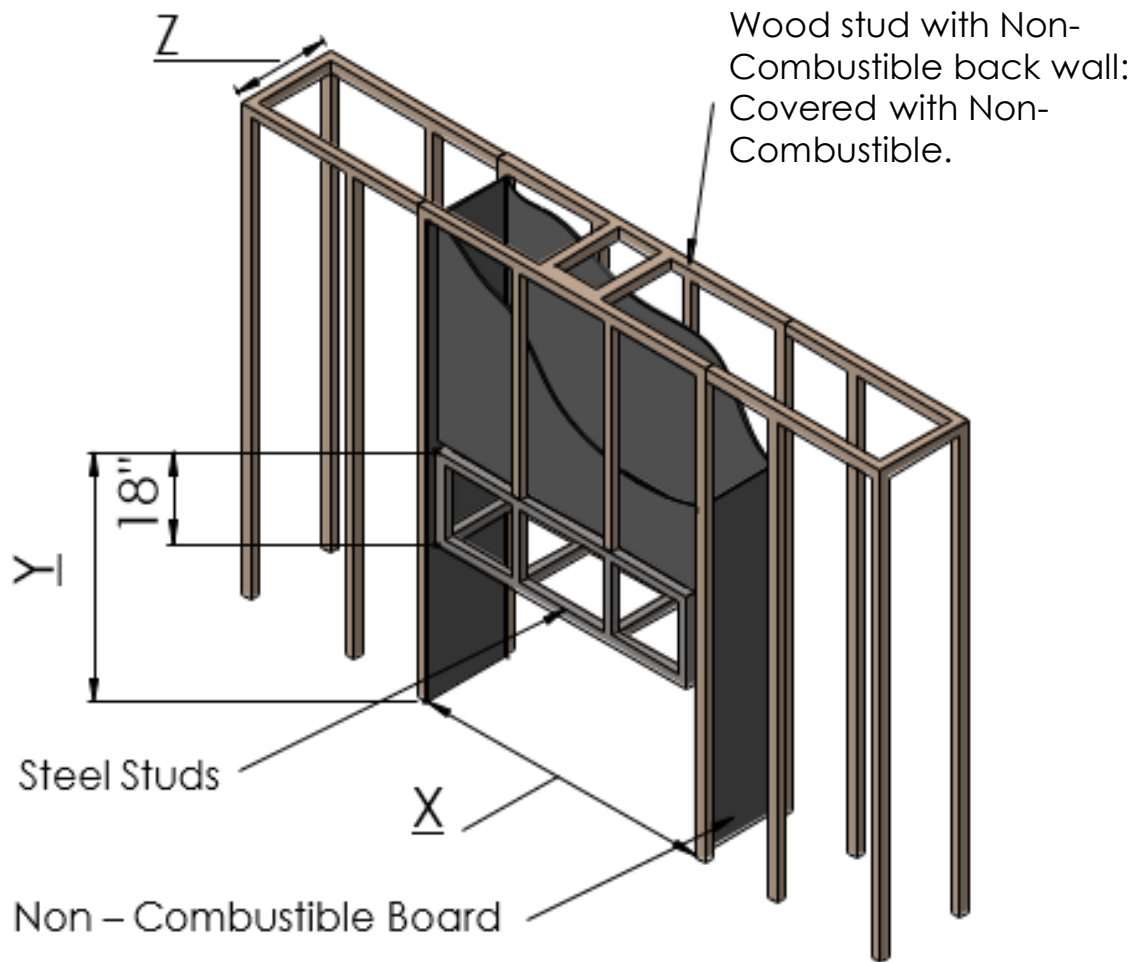

NOTE: Dimension 'Y' uses legs at default lowest height 4" below the unit with glass beginning 10" above the floor. Increase leg height and Y dimension for higher viewing window.

		X	Y	Z	
				Flat Installation	Recess Installation (4" Max)
45	Inch	51 ⁹ / ₁₆	64 ¹¹ / ₁₆	18 ¹ / ₁₆	26 ¹ / ₁₆
	mm	1294	1643	459	662
50	Inch	58 ⁵ / ₁₆	64 ¹¹ / ₁₆	18 ¹ / ₁₆	26 ¹ / ₁₆
	mm	1481	1643	459	662
60	Inch	68 ² / ₁₆	64 ¹¹ / ₁₆	18 ¹ / ₁₆	26 ¹ / ₁₆
	mm	1730	1643	459	662
70	Inch	78 ³ / ₁₆	64 ¹¹ / ₁₆	18 ¹ / ₁₆	26 ¹ / ₁₆
	mm	1986	1643	459	662
80	Inch	90 ⁹ / ₁₆	64 ¹¹ / ₁₆	18 ¹ / ₁₆	26 ¹ / ₁₆
	mm	2300	1643	459	662
100	Inch	107 ⁸ / ₁₆	64 ¹¹ / ₁₆	18 ¹ / ₁₆	26 ¹ / ₁₆
	mm	2731	1643	459	662

WOOD FLAT - SIDE VIEW

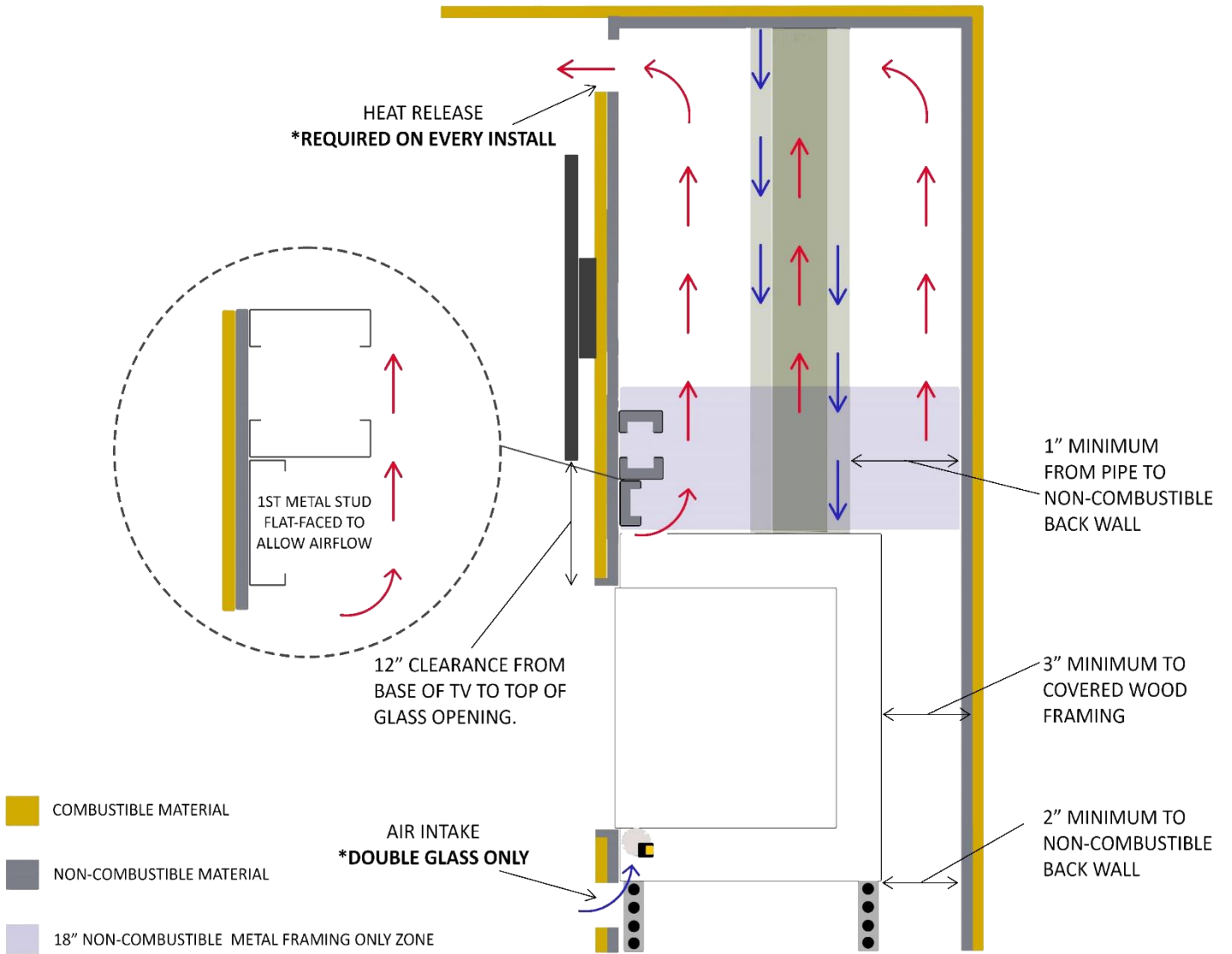

CLEARANCES TO SIDE AND BACK

