

DreamCast

Quadra 60



DRAMATIC FIRE

Our **Quadra** Fire Tables is a stunning addition to any outdoor living area. One of our most popular designs providing both ample table space for entertainment and cozy ambiance this fire table is available in 3 sizes.

Product Features/ Specifications:

- 65K BTU and 150K BTU
- Liquid Propane or Natural Gas
- Complimentary Lava Rocks
- Other media available for purchase
- Manual Lit Ignition (available for upgrade to Electronic Ignition - please contact for further information)
- Weight: 374 lbs.
- Overhead clearance: 84" - 120" (depending on burner) and 36" horizontally to combustibles.

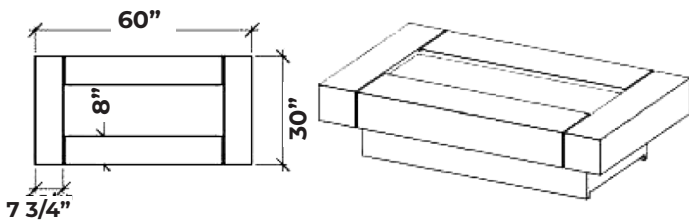
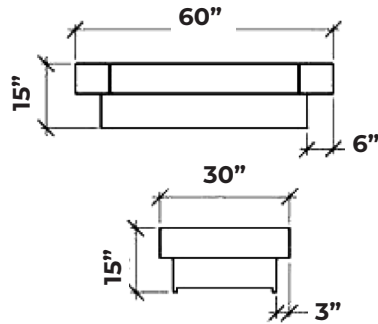
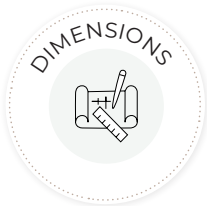

Min. and Max. Gas Inlet Pressures:

The installer is responsible for using the correct fuel lines and/or regulation to provide gas to the fire feature within the specified minimum and maximum gas inlet pressures.

Gas Inlet Pressures

Match Light	Minimum	Maximum
Natural Gas	3.5" W.C. (.8718Kpa)	7.0" W.C. (1.7436Kpa)
Liquid Propane	11.0" W.C. (2.7399 Kpa)	13.0" W.C. (3.2381 Kpa)



DreamCast
Design & Production

Please contact us at **1-604-278-4939** with any questions. We also encourage you to explore our website at www.dreamcastdesign.com

Our experienced team can assist you with product information, installation and design recommendations.

Quadra 60

DreamCast

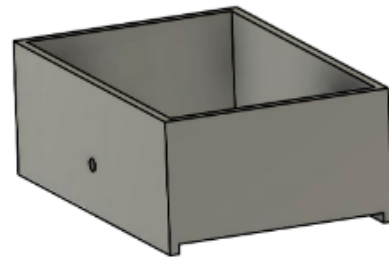
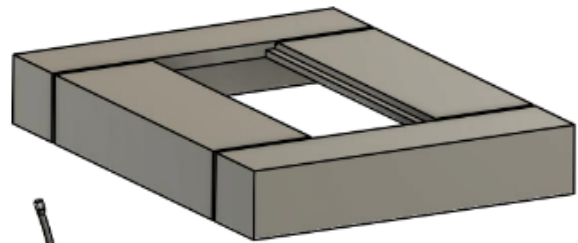
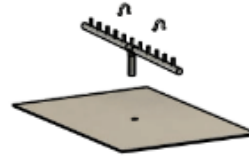
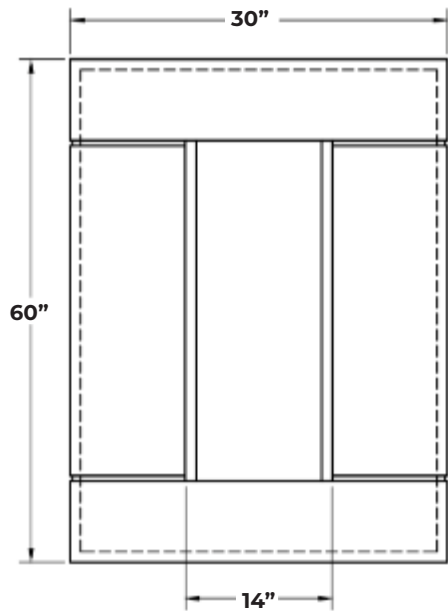
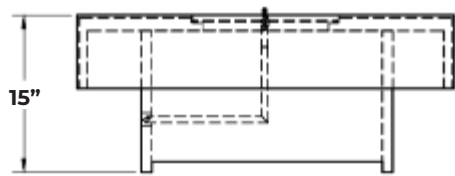

Warm up your days with this versatile aura fire bowl. Complete with an 8" rim for greater functionality this stunning fire bowl adds warmth and ambience to any outdoor space. Warm up your days with this versatile aura fire bowl. Complete with an 8" rim for greater functionality this stunning fire bowl adds warmth and ambience to any outdoor space.

DreamCast
Design & Production

Please contact us at [1-604-278-4939](tel:1-604-278-4939) with any questions. We also encourage you to explore our website at www.dreamcastdesign.com

Our experienced team can assist you with product information, installation and design recommendations.