

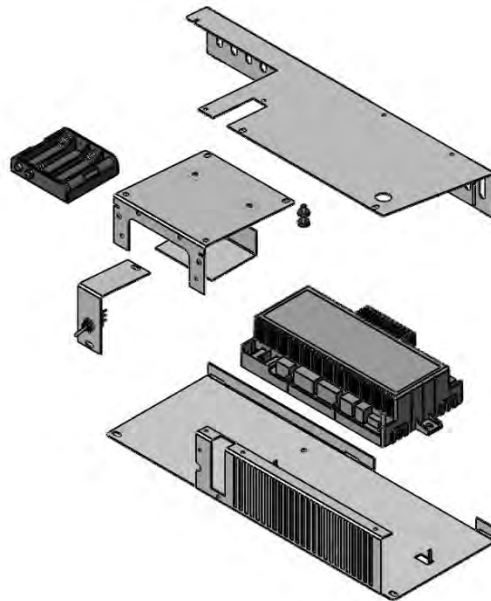

IPI Electronic Ignition Proflame 2 Valve System



This fireplace burner system has been equipped with electronic ignition. Please follow enclosed instructions for installation.

Keep these instructions with the appliance for future reference.

2340 Logan Avenue, Winnipeg, MB R2R 2V3
Phone 204-632-1962 Fax 204-632-1960
October 13, 2017 IPI-MAN2

Table of Contents

Table of Contents.....	2
Proflame 2 Parts List.....	3
Proflame 2 Basic Configuration.....	3
Proflame 2 GTMFL.....	4
Proflame 2 Module.....	5
Proflame 2 Remote Control.....	6
Electronic Ignition Lighting Instructions.....	7

Proflame 2 Parts List

ITEM NO.	PART NUMBER	DESCRIPTION
1.	1005-P001si	IPI Valve NG with Stepper Motor 885.001
2.	1005-P002si	IPI Valve LP with Stepper Motor 885.001
3.	1005-P325si	Module IPI PF2 584.325
4.	1005-P924si	Harness PF2 IPI 584.924
5.	1005-P042si	Transmitter PF2 584.042
6.	1002-P033si	Pilot NG IPI 199.059
7.	584-PWR-C	Wire Harness PF2 Main Power Cord
8.	584-X4P	Connector- ON/OFF Jumper PF2 651-1766990
9.	584-X10	Wire Harness PF2 - Accessories
10.	584-ACC01-C	Wire Harness PF2
11.	1001-P591si	Battery AAA 658-LR03XWA Transmitter
12.	1002-P12BH	Battery Housing
13.	1005-P2SCH	Label – PF2 Schematic Decal
14.	1006-P307si	Integrated Fireplace Control (Basic) 0.584.307
15.	1006-P920si	Wire harness (Valve, APS connection Jumped, CPI connection) 0.584.920
16.	1006-P921si	Wire harness for Split flow 0.584.921 (Not available)
17.	584-X12	Power Vent Harness
18.	1006-P002si	IPI Valve NG Hi / Lo
19.	1006-P003si	IPI Valve LP Hi / Lo

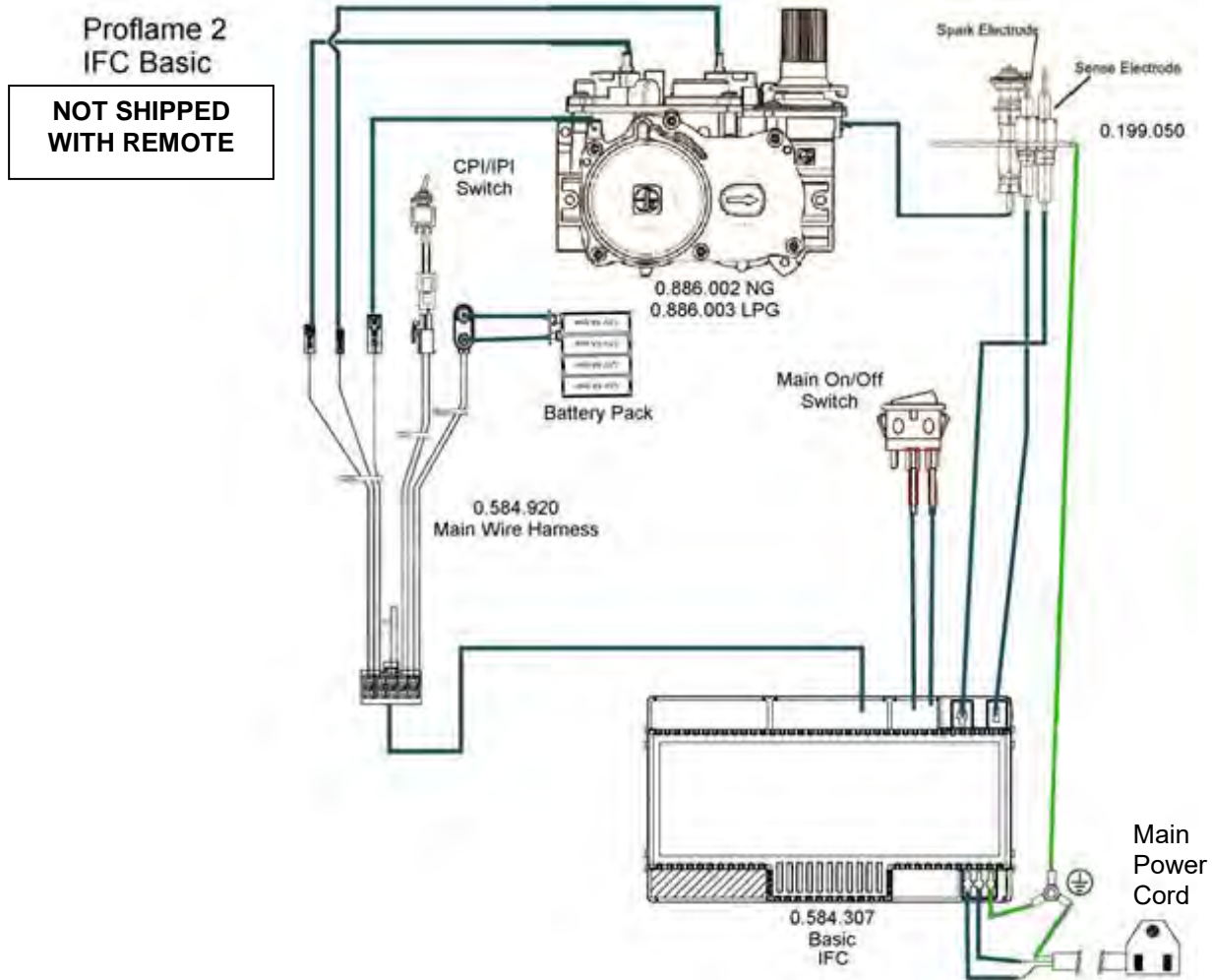

Profame 2 System Configuration:

GTMFL SHIPS WITH REMOTE CONTROL TRANSMITTER

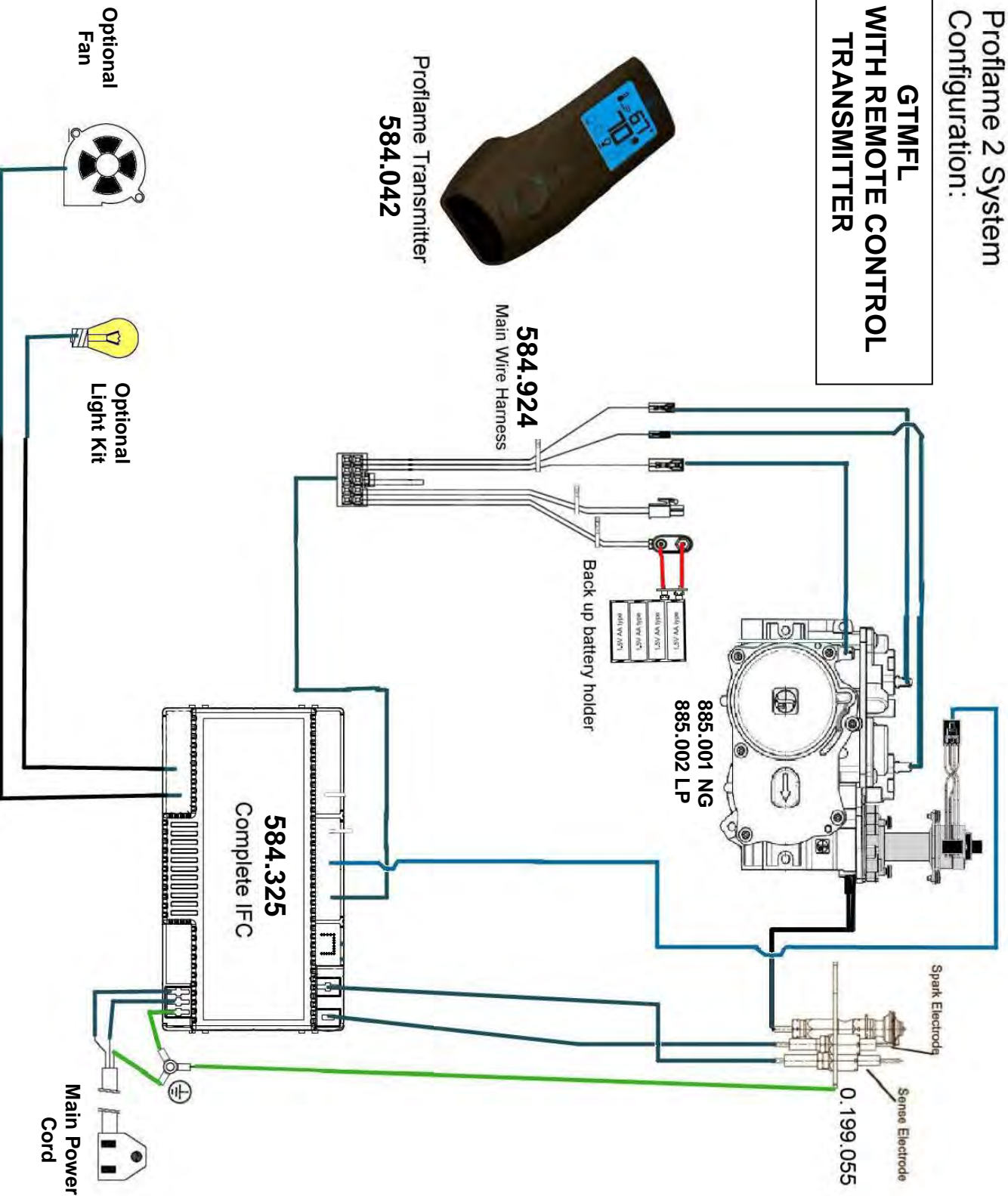

Proflame 2 Module

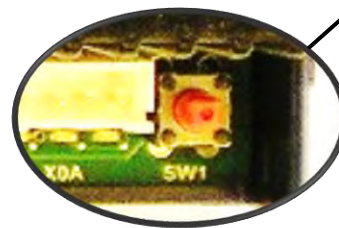
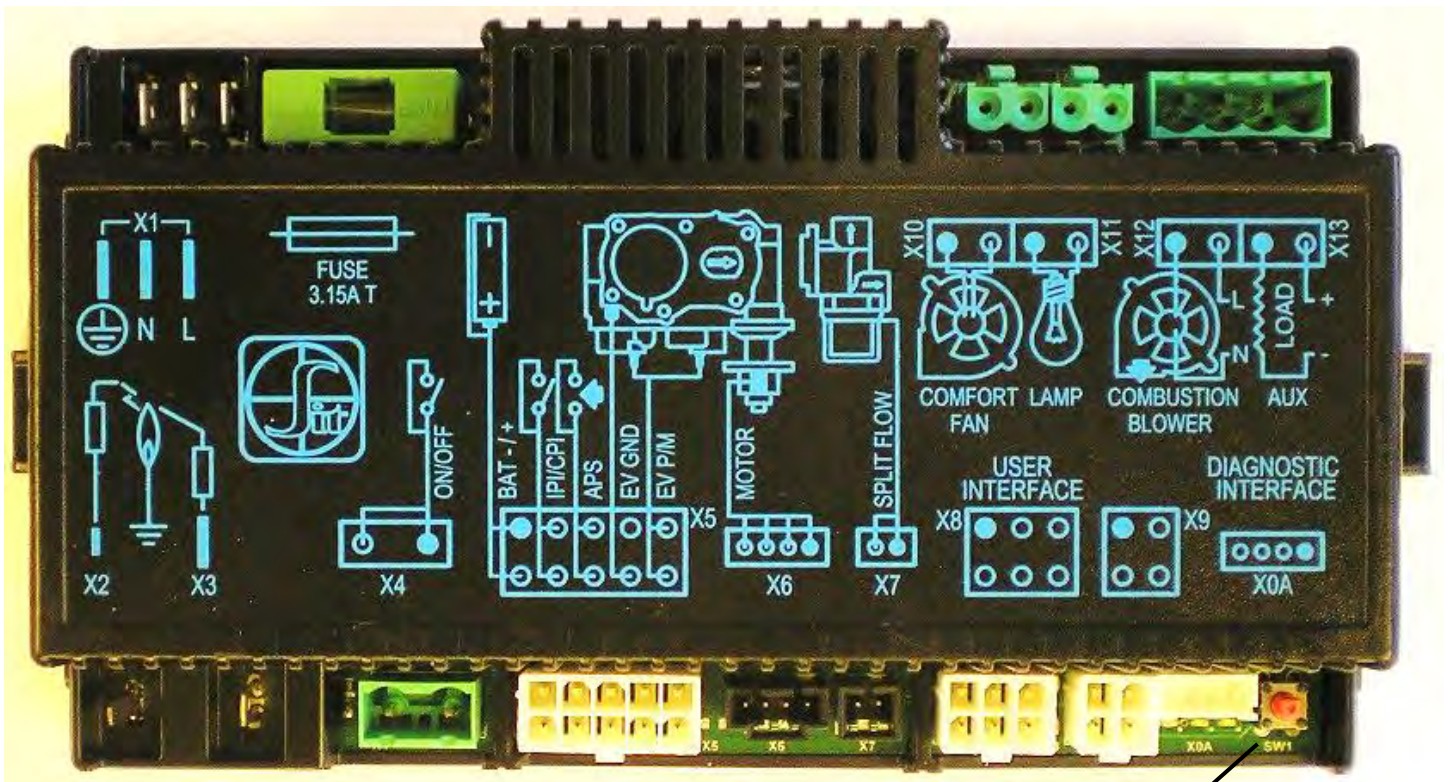

SW1 Switch

INTRODUCTION

The Proflame2 IFC (Integrated Fireplace Control) board is a device that allows the automatic ignition and pilot flame supervision, to command the functions of a hearth appliance.

It is configured to control the ON/OFF main burner operation, giving the choice of both IPI (intermittent pilot ignition), and CPI (continuous pilot ignition) modes.

The Proflame2 IFC board controls directly the pilot assembly and an automatic valve 880, 886 and 885 of the Proflame families using low voltage electric power.

The IFC board is powered by Line voltage (AC) with provision of battery back up in case of main power loss. Fans and lighting features will not function when the IFC is powered by battery backup.

The Proflame IFC has the ability to control the comfort fan through 6 speeds, modulate an accent light through 6 levels and switch on or off an auxiliary output via the remote transmitter.

Low battery power detection

The life span of the receiver batteries depends on various factors: quality of the batteries used, the number of ignitions of the appliance, the number of changes to the room thermostat set point, etc. When the receiver batteries are low a “double-beep” will be emitted from the IFC when it receives an On/Off command from the transmitter.

This is an alert for a low battery condition of the receiver and after that no more command will be accepted. When the batteries are replaced the “beep” will be emitted from the receiver as soon as powered.

Proflame 2 Remote Control

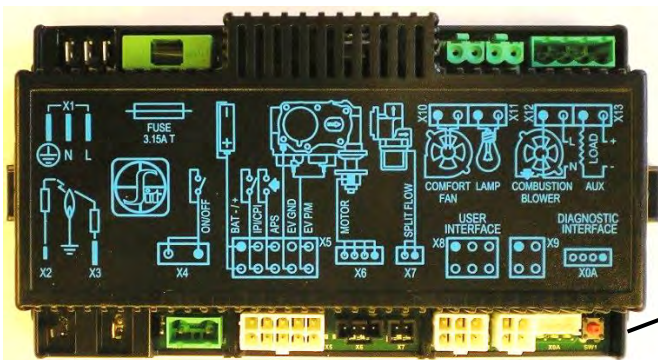

Pairing Remote Control:

- Install the 3 AAA type batteries in the battery bay, located on the base of the Remote Control. Note polarity of the batteries and insert them as indicated.
- Connect the AC power supply to the IFC.
- Press the SW1 button on the IFC module so the IFC will “beep” and a red LED is illuminated to indicate that the IFC is ready to synchronize with a Remote Control within 10 seconds. With the batteries already installed in the Remote Control, push the ON button. The receiver will “beep” four times to indicate the Remote Control’s command is accepted.

The system is now initialized.

Resetting Proflame II Module for Manual Use

Should the transmitter get misplaced, broken or not wanted the PF2 Module can be reset to a manual system. A manual on/off switch or thermostat may be installed at the X4 connector (this connection is Jumped at the factory) no power is required.

The following sequence must be followed to reset the PF2 Module:

- Press the Red **SW1** button until you hear three beeps.

- Within 10 seconds press the **SW1** button again until you hear it beep.
- The PF2 module may now be turned on/off manually (x4 connector) by a switch (not supplied), the pilot will remain on CPI (continuous pilot ignition) mode, all other functions of main burner, fan and lights will be on the high setting.

Fan Startup and Shutdown Timings:

Fan setting is started with a delay of 5 minutes from the fireplace ignition and stopped with a delay of 12 minutes from the fireplace switching off.

Low battery power detection

When the Remote Control’s batteries are low, a Battery Icon will appear on the LCD display before all power is lost. When the batteries are replaced this icon will disappear.

Battery backup

The PF2 module is powered by line voltage (AC) with provision of battery backup in case of main power loss. Fans and lighting features will not function with the PF2 module is powered by battery backup. It is recommended that the 4 x AA batteries are changed before each heating season.

Electronic Ignition Lighting Instructions

WARNING

If you do not follow these instructions exactly, a fire or explosion may result causing property damage, personal injury or loss of life.

Always light the pilot whether for the first time or if the gas supply has ran out with the glass door opened or removed.



FOR YOUR SAFETY READ BEFORE LIGHTING:

- A. This fireplace is equipped with an ignition device which automatically lights the pilot. Do not try to light by hand.
- B. Before operating smell all around the fireplace area for gas and next to the floor because some gas is heavier than air and will settle on the floor.
- C. Do not use this fireplace if any part has been under water. Immediately call a qualified service technician to inspect the fireplace and replace any part of the control system and any gas control which has been under water.

WHAT TO DO IF YOU SMELL GAS:

- Turn off all gas to the fireplace.
- Open windows.
- Do not try to light any appliance.
- Do not touch any electric switch; do not use any phone in your building.
- Immediately call your gas supplier from a neighbor's phone. Follow the gas supplier's instructions.
- If you cannot reach your gas supplier, call the fire department.

LIGHTING INSTRUCTIONS

1. Stop! Read the above safety information on this label.
2. Remove batteries from receiver, and/or Battery Backup Pack.
3. Turn off all electric power to the fireplace.
4. This fireplace is equipped with an ignition device which automatically lights the pilot. Do not try to light the pilot by hand.
5. Open the glass door.
6. Turn manual shutoff valve clockwise  to off (Located behind the access panel).
7. Wait five (5) minutes to clear out any gas. If you smell gas including near the floor, **STOP!** Follow "B" in the above safety information on this label. If you don't smell gas go to the next step.
8. Turn manual shutoff valve counter-clockwise  to on.
9. Close the glass door.
10. Turn on all electric power to the fireplace and re-install batteries into the Transmitter/Receiver, and/or Battery Backup Pack.
11. Turn "On" Switch that operates the Main Burner. If using a Remote Control refer to Remote Control Operation Manual for activation.

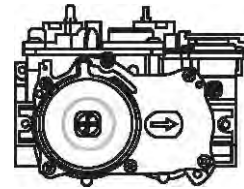

TO TURN OFF GAS

1. Turn off all electric power to the fireplace if service is to be performed, including removing batteries from Remote Transmitter/Receiver and/or Battery Backup Pack.
2. Access door inside the firebox must be removed to access the manual shutoff valve.
3. If alternate shut-off valve was installed it can be shutoff instead of going through the fireplace to access the fireplace shut off valve.