



**Unit Illustrated:** Model MQVLBG60NE2 Bay Peninsula Direct Vent Fireplace (Natural Gas), MQG5C Glass Media (Bronze x3), MQVL60RGB Reflective Glass Liner (Back).  
(Chase must be vented below and above appliance – consult manual for instructions).

# ENCLAVE

ZERO CLEARANCE DIRECT VENT  
BAY PENINSULA GAS FIREPLACE

 marquis  
COLLECTION

# CREATING A NEW DIMENSION

Its wraparound view captivates from every angle. Luring you in with its three-dimensional sightlines, the **ENCLAVE** from Marquis creates a sleek and cleverly designed gathering point for the heart of your home.

Amazingly versatile, this beguiling fireplace adapts to suit any room with options for a Single Side, Corner or a Bay Peninsula. It transforms completely with your choice of fireplace liner and accessories that range from driftwood logs and contemporary rocks to cannonballs and glass.

With the **ENCLAVE'S** innovative vented chase technology you may now cover the fireplace with combustible materials up to the glass door opening.

Follow the instructions in the manual for venting the chase (opening above and below the appliance is required).

Visit [marquisfireplaces.net](http://marquisfireplaces.net) to see the latest evolution in fireplaces.

## ENCLAVE FEATURES

### STANDARD

- Accent Lighting:  
**Enclave 48/60/72** – LED Lighting (non-dimmable)  
**Enclave 34** – Halogen Lighting
- Proflame II Models include Remote Control with the following features: flame adjustment, thermostat, smart thermostat (WIFI Compatibility) and accent lighting control
- Zero Clearances to TVs and Artwork
- Invisible Glass Safety Barrier

### BENEFITS OF OUR VENTED CHASE TECHNOLOGY

- No fans required to vent the chase, will work during power failures (batteries required)
- Allows for all wood framing
- Combustible materials may be used right up to the glass door opening
- Seamless glass, removes the need for steel safety screen barrier
- Allows for reduced mantel clearances
- Ultra-low TV clearances



\* Amazon Alexa, Google Home, Smartphone

### OPTIONAL

#### Surrounds:

Black or Stainless; Single-Sided Models only

#### Liners:

**Enclave 48/60/72** – Reflective Glass, Fluted Brick, and Stacked Brick

**Enclave 34** – Reflective Glass, Fluted and Traditional Brick

#### Media Options (Required):

Glass Media (Glacier Ice, Cobalt Blue, Black, Bronze, White)

#### Additional Media (Optional):

Cannonballs, Decorative Stones, Contemporary Rocks (natural and multi-colored), Ember Chunks

#### Log Sets:

Oak, Birch, and Driftwood Sets

#### Enclosure Grills:

Front or Sides – Unfinished

#### Corner Kit:

Available for Bay Peninsula Unit

#### Side Extension Panels:

Black; Single-Sided Models only

#### Heat Distribution System:

Plenum (Enclave 48 only)

Heat Distribution System: Flex Piping

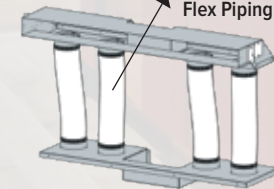



**Unit Illustrated:** Model MQVLBG48NE2 Bay Peninsula Direct Vent Fireplace (Natural Gas), VL48EG Grill Kit for Enclosure, MQRBRW Birch Log Set, MQG5C Glass Media (Bronze x2), MQSTONE10 Decorative Stones, MQVL48RGB Reflective Glass Liner (Back).  
(Chase must be vented below and above appliance – consult manual for instructions).

# ENCLAVE 34

<b>MODEL</b>	MQZCVBG34NE2	MQZCVBG34LPE2
<b>Type</b>	BAY PENINSULA	BAY PENINSULA
<b>Fuel</b>	Natural	Propane
<b>Gas Control</b>	IPI PF2	IPI PF2
<b>Input Max.</b>	25,000 BTU	24,000 BTU
<b>Input Min.</b>	17,500 BTU	19,000 BTU
<b>Venting*</b>	5"/8"	5/8"
<b>Glass Size</b>	33 11/16" W X 22" H	33 11/16" W X 22" H
<b>Glass Type</b>	Ceramic	Ceramic
<b>FE (P.4.1-15)</b>	52.94%	51.96%

### Ventilation Required:

**THE FIREPLACE CHASE MUST BE VENTED ABOVE THE APPLIANCE\*\***

**THIS UNIT CAN BE CONVERTED TO A CORNER INSTALLATION**

*\*This appliance is approved for use with 5"/8" Kingsman Flex, M&G-DuraVent Direct Vent system (Model DV-GS Series) and Snorkel, BDM Pro Form Direct Vent, Ameri-Vent Direct Vent Pipe System, ICC Excel Direct, Metal Fab Sure-Seal DV and Selkirk Direct Temp. When using ICC Excel Direct a one-foot section of 5"/8" MG DuraVent must be used as a starter collar at the flue of the appliance.*

*\*\*Consult Installation Manual for requirements and further clarification.*

**Unit Illustrated:** Model MQZCVBG34NE2 Direct Vent Fireplace (Natural Gas), VL34EG Grill Kit for Enclosure, MQLOGF453 Driftwood Log Set, MQZCVBG34RGB Reflective Glass Liner (Back).  
(Chase must be vented above appliance – consult manual for instructions).



**\*NOTE:** the fireplace chase must be vented above the appliance.



**Unit Illustrated:** Model MQZCVBG34NE2 Bay Peninsula Direct Vent Fireplace (Natural Gas), MQLOGF34BW Birch Log Set, and MQZCVBG34RGB Reflective Glass Liner (Back).  
(Chase must be vented above appliance – consult manual for instructions).

# ENCLAVE 48



MQVLBG48NE2 Bay Peninsula Direct Vent Fireplace (Natural Gas), VLBGCK Corner Kit, MQG5C Glass Media (Bronze x2), MQRBD3 Driftwood Log Set.



MQVLBG48NE2 Direct Vent Fireplace (Natural Gas), VLBGCK Corner Kit, MQG5C Glass Media (Bronze x2), MQ46D Driftwood Log Set, MQVL48RGB Reflective Glass Liner (Back).



MQVLBG48NE2 Direct Vent Fireplace (Natural Gas), MQG5C Glass Media (Bronze x2), MQVL48RLFB2 Fluted Brick Liner (Back)

*\*This appliance is approved for use with 5"8" Kingsman Flex, M&G-DuraVent Direct Vent system (Model DV-GS Series) and Snorkel, BDM Pro Form Direct Vent, Ameri-Vent Direct Vent Pipe System, ICC Excel Direct, Metal Fab Sure-Seal DV and Selkirk Direct Temp. When using ICC Excel Direct a one-foot section of 5"8" MG DuraVent must be used as a starter collar at the flue of the appliance.*

*\*\*Consult Installation Manual for requirements and further clarification.*

MODEL	MQVLBG48NE2	MQVLBG48LPE2	MQVL48NE2	MQVL48LPE2
Type	BAY PENINSULA	BAY PENINSULA	SINGLE-SIDED	SINGE-SIDED
Fuel	Natural Gas	Propane	Natural Gas	Propane
Gas Control	IPI PF2	IPI PF2	IPI PF2	IPI PF2
Input Max.	35,000 BTU	35,000 BTU	35,000 BTU	35,000 BTU
Input Min.	25,000 BTU	27,000 BTU	25,000 BTU	27,000 BTU
Venting*	5"8"	5"8"	5"8"	5"8"
Glass Size	49 1/6" W x 17 7/8" H	49 1/6" W x 17 7/8" H	49 1/6" W x 17 7/8" H	49 1/6" W x 17 7/8" H
Glass Type	Ceramic	Ceramic	Ceramic	Ceramic
FE (P.4.1-15)	53.20%	53.20%	53.20%	53.20%

**Ventilation Required:**

**THE FIREPLACE CHASE MUST BE VENTED BOTH ABOVE AND BELOW APPLIANCE\*\***

**ABOVE the appliance:**  
151 sq./in.

**BELOW the appliance:**  
84 sq./in.

**Unit Illustrated:** Model MQVLBG48NE2 Bay Peninsula Direct Vent Fireplace (Natural Gas), VLBGCK Corner Kit, MQG5C Glass Media (Bronze x2), MQSTONE Decorative Stones, MQVL48RGB Reflective Liner (Back) and MQVL48RGE Reflective Glass Liner (Ends).

(Chase must be vented below and above appliance – consult manual for instructions).



## ENCLAVE 48 ADJUSTABLE VENTED PLATFORMS

Save on framing and adjust platform to your required height. Height is variable from 15" to 27". Ventilation Slots are provided at the bottom and between the fireplace and the platform.

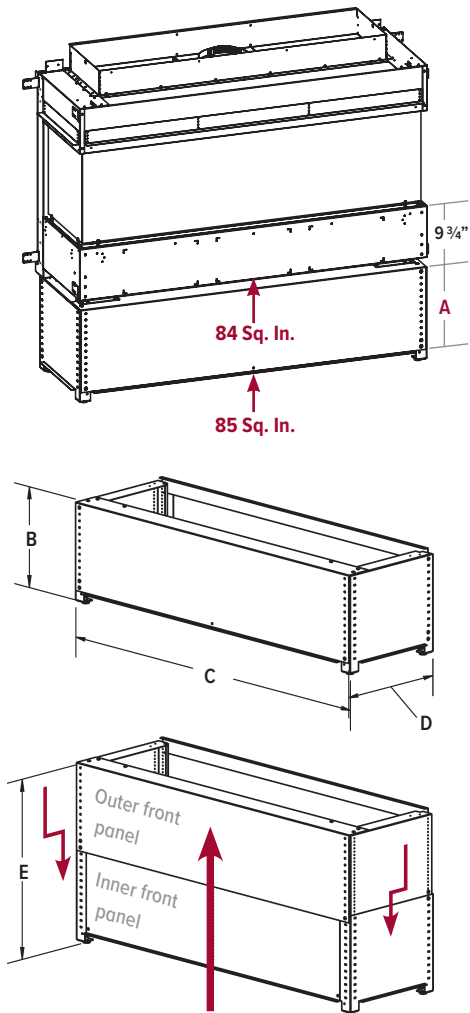



### VL48AVP

- A 15" to 27"
- B 15"
- C 56"
- D 17 1/8"
- E 27"

NOTE: the fireplace chase must be vented both above and below appliance, no fans are required.

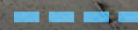
Unit Illustrated: Model MQVL48NE2 Direct Vent Fireplace (Natural Gas), VL48EG Grill Kit for Enclosure, MQG5W Glass Media (White x2), MQVL48RGB Reflective Glass Liner (Back), MQVL48RGE Reflective Glass Liner (Ends), MQVL48S1BL Surround (Black).  
(Chase must be vented below and above appliance – consult manual for instructions).

 Room air coming **IN**  
 Hot air coming **OUT**

Your choice of enclosure grill (front or sides) or top opening is required

Use any finish (including combustibles) right to the edge of the fireplace door opening

Design your own chase vent solution to suit your style\*

\*NOTE: the fireplace chase must be vented both above and below appliance.



# ENCLAVE 60



MQVLBG60NE2 Bay Peninsula Direct Vent Fireplace (Natural Gas), MQG5C Glass Media (Bronze x 3), MQLOGF48D Driftwood Log Set, MQSTONE10 Decorative Stone (10 PCE), MQVL60RLSB Stacked Brick Liner.



MQVLBG60NE2 Bay Peninsula Direct Vent Fireplace (Natural Gas), MQG5C Glass Media (Bronze x3), MQVL60RBRG Reflective Glass Liner (Back).



MQVLBG60NE2 Bay Peninsula Direct Vent Fireplace (Natural Gas), MQG5C Glass Media (Bronze x 3), MQRBD3 Driftwood Log Set (5 PCE), MQSTONE10 Decorative Stones (10 PCE), MQVL60RLSB Stacked Brick Liner.

*\*This appliance is approved for use with 5"8" Kingsman Flex, M&G-DuraVent Direct Vent system (Model DV-GS Series) and Snorkel, BDM Pro Form Direct Vent, Ameri-Vent Direct Vent Pipe System, ICC Excel Direct, Metal Fab Sure-Seal DV and Selkirk Direct Temp. When using ICC Excel Direct a one-foot section of 5"8" MG DuraVent must be used as a starter collar at the flue of the appliance.*

*\*\*Consult Installation Manual for requirements and further clarification.*

MODEL	MQVLBG60NE2	MQVLBG60LPE2	MQVL60NE2	MQVL60LPE2
Type	BAY PENINSULA	BAY PENINSULA	SINGLE-SIDED	SINGE-SIDED
Fuel	Natural Gas	Propane	Natural Gas	Propane
Gas Control	IPI PF2	IPI PF2	IPI PF2	IPI PF2
Input Max.	45,000 BTU	44,000 BTU	45,000 BTU	44,000 BTU
Input Min.	32,000 BTU	35,000 BTU	32,000 BTU	35,000 BTU
Venting*	5"8"	5"8"	5"8"	5"8"
Glass Size	61 1/32" W x 17 7/8" H	61 1/32" W x 17 7/8" H	61 1/32" W x 17 7/8" H	61 1/32" W x 17 7/8" H
Glass Type	Ceramic	Ceramic	Ceramic	Ceramic
FE (P.4.1-15)	56.18%	56.52%	56.18%	56.52%

## Ventilation Required:

**THE FIREPLACE CHASE MUST BE VENTED BOTH ABOVE AND BELOW APPLIANCE\*\***

**ABOVE the appliance:**  
200 sq./in.

**BELOW the appliance:**  
102 sq./in.



**Unit Illustrated:** Model MQVLBG60NE2 Bay Peninsula Direct Vent Fireplace (Natural Gas), VL60EG Grill Kit for Enclosure, MQG5C Glass Media (Bronze x3), MQVL60RLSB Stacked Brick Liner. (Chase must be vented below and above appliance – consult manual for instructions).



## ENCLAVE 60 ADJUSTABLE VENTED PLATFORMS

Save on framing and adjust platform to your required height. Height is variable from 15" to 27". Ventilation Slots are provided at the bottom and between the fireplace and the platform.

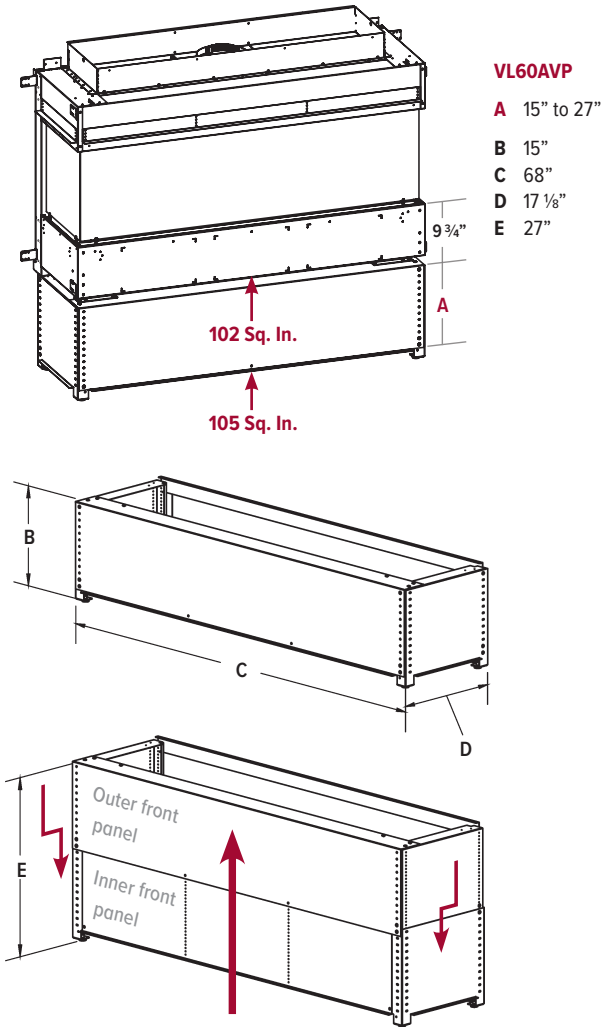

NOTE: the fireplace chase must be vented both above and below appliance, no fans are required.

Unit Illustrated: Model MQVL60NE2 Direct Vent Fireplace (Natural Gas), MQG5C Glass Media (Bronze x3), RBCB1 Cannonballs, MQVL60RGB Reflective Glass Liner (Back), MQVL48RGE Reflective Glass Liner (End).  
 (Chase must be vented below and above appliance – consult manual for instructions).

Room air coming IN  
 Hot air coming OUT

Zero clearances to TVs and artwork

Use any finish (including combustibles) right to the edge of the fireplace door opening

Design your own chase vent solution to suit your style\*

\*NOTE: the fireplace chase must be vented both above and below appliance.



# ENCLAVE 72



MQVLBG72NE2 Bay Peninsula Direct Vent Fireplace (Natural Gas), MQG5W Glass Media (White x3), MQVL72RGB Reflective Glass Liner (Back).



MQVL72NE2 Single Side Direct Vent Fireplace (Natural Gas), MQG5A Glass Media (Cobalt x3), MQVL72RGB Reflective Glass Liner (Back).



MQVLBG72NE2 Bay Peninsula Direct Vent Fireplace (Natural Gas), MQG5C Glass Media (Bronze x 3), MQLOGF48D Driftwood Log Set, MQSTONE10 Decorative Stones (10 piece), MQVL72RGB Reflective Glass Liner (Back).

*\*This appliance is approved for use with 5"8" Kingsman Flex, M&G-DuraVent Direct Vent system (Model DV-GS Series) and Snorkel, BDM Pro Form Direct Vent, Ameri-Vent Direct Vent Pipe System, ICC Excel Direct, Metal Fab Sure-Seal DV and Selkirk Direct Temp. When using ICC Excel Direct a one-foot section of 5"8" MG DuraVent must be used as a starter collar at the flue of the appliance.*

*\*\*Consult Installation Manual for requirements and further clarification.*

MODEL	MQVLBG72NE2	MQVLBG72LPE2	MQVL72NE2	MQVL72LPE2
Type	BAY PENINSULA	BAY PENINSULA	SINGLE-SIDED	SINGE-SIDED
Fuel	Natural Gas	Propane	Natural Gas	Propane
Gas Control	IPI PF2	IPI PF2	IPI PF2	IPI PF2
Input Max.	50,000 BTU	50,000 BTU	50,000 BTU	50,000 BTU
Input Min.	34,000 BTU	39,000 BTU	34,000 BTU	39,000 BTU
Venting*	5"8"	5"8"	5"8"	5"8"
Glass Size	73 1/16" W x 17 7/8" H	73 1/16" W x 17 7/8" H	73 1/16" W x 17 7/8" H	73 1/16" W x 17 7/8" H
Glass Type	Ceramic	Ceramic	Ceramic	Ceramic
FE (P.4.1-15)	60.32%	60.32%	60.32%	60.32%

### Ventilation Required:

**THE FIREPLACE CHASE MUST BE VENTED BOTH ABOVE AND BELOW APPLIANCE\*\***

**ABOVE the appliance:**  
285 sq./in.

**BELOW the appliance:**  
158 sq./in.



**Unit Illustrated:** Model MQVLBG72NE2 Bay Peninsula Direct Vent Fireplace (Natural Gas), MQG5W Glass Media (White x3), MQLOGF48D Driftwood Log Set, MQSTONE10 Decorative Stone (10 piece), MQVL72RGB Reflective Glass Liner (Back).

(Chase must be vented below and above appliance – consult manual for instructions).

## ENCLAVE 72 ADJUSTABLE VENTED PLATFORMS

Save on framing and adjust platform to your required height. Height is variable from 15" to 27". Ventilation Slots are provided at the bottom and between the fireplace and the platform.

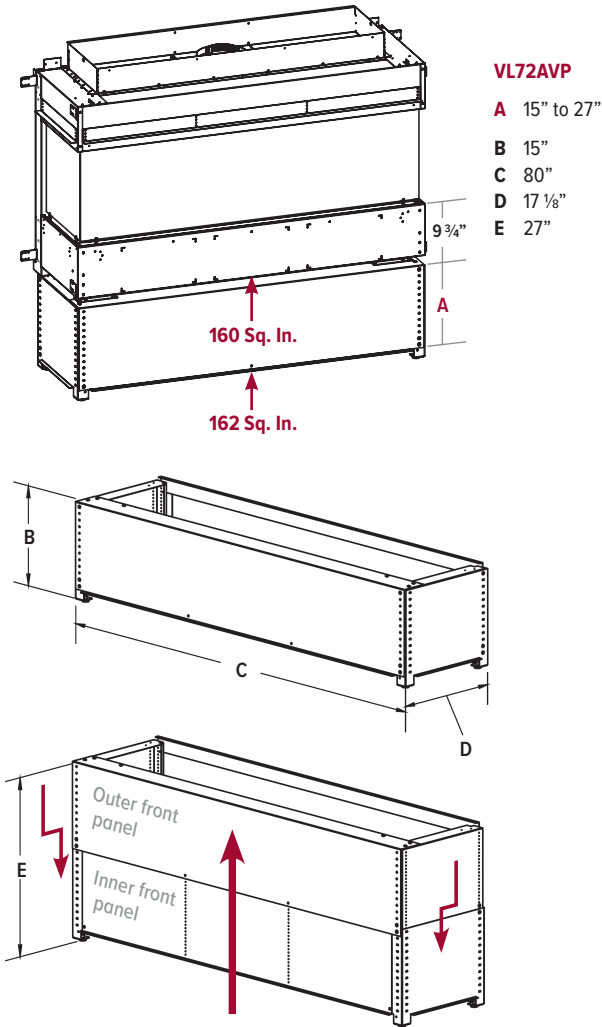

NOTE: the fireplace chase must be vented both above and below appliance, no fans are required.

Unit Illustrated: Model MQVL72NE2 Direct Vent Fireplace (Natural Gas), MQG5A Glass Media (Cobalt x3), MQVL72RGB Reflective Glass Liner (Back), VL72S1SS Surround (Stainless Steel). Shown with Optional VL72EG Grill (Front Enclosure x2). (Chase must be vented below and above appliance – consult manual for instructions).

Room air coming **IN**

Hot air coming **OUT**

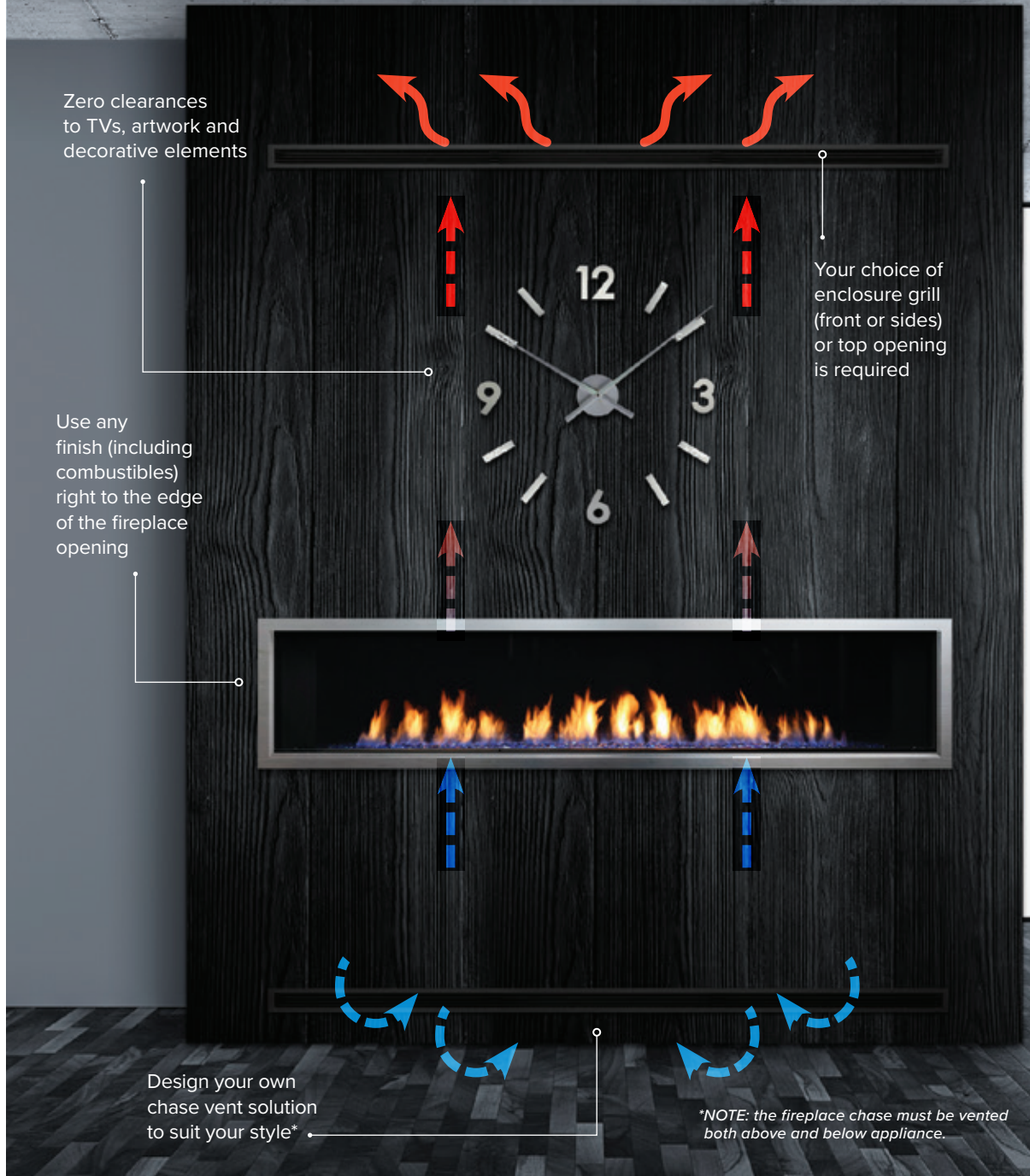

# ENCLAVE PRODUCT SPECIFICATIONS

## DIMENSIONS

<b>MQVLBG34</b> Bay Peninsula	<b>MQVL48</b> Single Side	<b>MQVLBG48</b> Bay Peninsula	<b>MQVL60</b> Single Side	<b>MQVLBG60</b> Bay Peninsula	<b>MQVL72</b> Single Side	<b>MQVLBG72</b> Bay Peninsula
A 16 7/16"	A 18 13/16"	18 13/16"	A 20 1/16"	20 1/16"	A 18 13/16"	18 7/8"
B 34 5/16"	B 56 1/2"	56 1/2"	B 68 1/2"	68 1/2"	B 80 1/2"	80 1/2"
C 37 5/8"	C 36 5/16"	36 5/16"	C 36 5/16"	36 5/16"	C 36 5/16"	36 5/16"
D 34 5/8"	D 46 3/8"	46 3/8"	D 58 1/2"	58 1/2"	D 70 1/2"	70 1/2"
E 34 1/8"	E 54 15/16"	54 15/16"	E 66 11/16"	66 5/8"	E 78 5/8"	78 5/8"
F 21 1/2"	F 49 1/16"	49 1/16"	F 61 1/32"	61 1/32"	F 73 3/16"	73 3/16"
G 7 9/16"	G 9 3/4"	9 3/4"	G 9 3/4"	9 3/4"	G 9 3/4"	9 3/4"
H 20 15/16"	H 15 1/4"	15 1/4"	H 15 1/4"	15 1/4"	H 15 1/4"	15 1/4"
I 9/16"	I 9/16"	-	I 1 1/16"	3/4"	I 1 1/16"	3/4"
J 3 1/2"	J 4"	4"	J 4"	4"	J 4"	4"
K 5 1/16"	K 7 5/16"	7 1/4"	K 7 5/16"	7 5/16"	K 7 5/8"	7 5/16"
L 4 7/16"	L 4 9/16"	4 9/16"	L 4 9/16"	4 9/16"	L 4 9/16"	4 9/16"
M 16 3/4"	M 18"	18"	M 18"	18"	M 18 7/8"	18 7/8"
N 37 5/8"	N 36 1/4"	36 1/4"	N 36 5/16"	36 5/16"	N 36 5/16"	36 5/16"
O -	O 8 1/4"	8 1/4"	O 8 1/4"	8 1/4"	O 8 1/4"	8 1/4"

## WALL SURROUND

for 48/60/72 Single Side

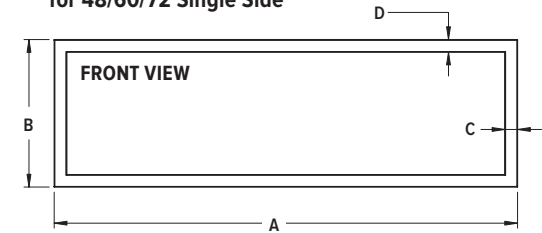

<b>VL48S1</b>	<b>VL60S1</b>	<b>VL72S1</b>
A 58 1/16"	70 1/16"	82 1/16"
B 18 1/2"	18 1/2"	18 1/2"
C 1 1/2"	1 1/2"	1 1/2"
D 1 1/2"	1 1/2"	1 1/2"

## SIDE EXTENSION PANELS

for 48/60/72 Single Side

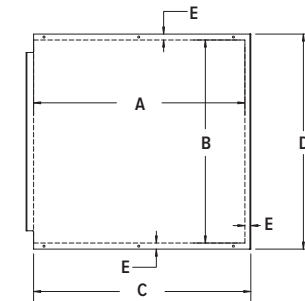

<b>VL48SEP</b>
A 17 7/8"
B 17 1/8"
C 18 3/8"
D 18 3/16"
E 1/2"

## CORNER KIT

34 Bay: ZCV34BGCK  
48/60/72 Bay: VLBGCK

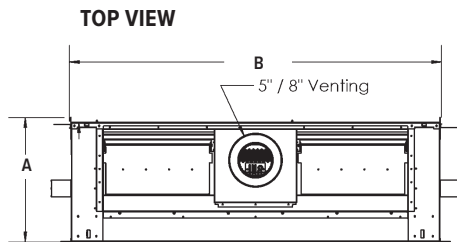
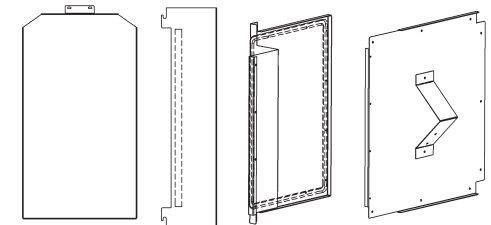

SIDE VIEW – SINGLE SIDED

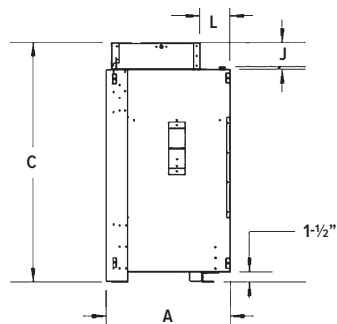

SIDE VIEW – BAY PENINSULA

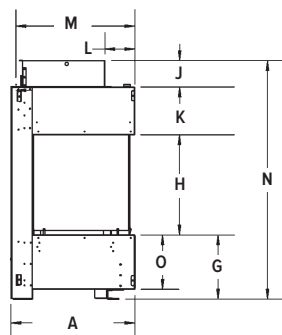

FRONT VIEW

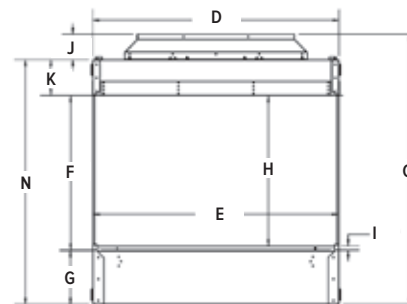

MQZCVBG34

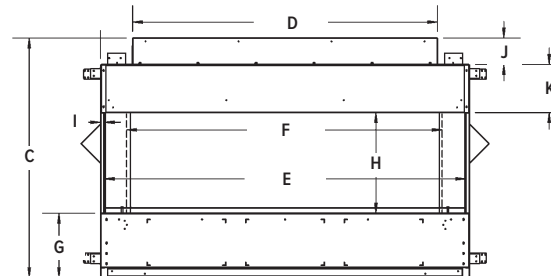

MQVLB48/60/72

**Unit Illustrated:** Model MQVLBG60NE2 Bay Peninsula Direct Vent Fireplace (Natural Gas), MQG5C Glass Media (Bronze x3), MQLOGF48D Driftwood Log Set, MQSTONE10 Decorative Stone, MQVL60RLSB Brick Liner (Stacked Brick).  
(Chase must be vented below and above appliance – consult manual for instructions).

## ENCLOSURE GRILL

### FRONT/TOP VIEW – VL34EG

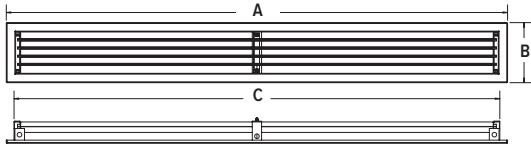

### FRONT/TOP VIEW – VL48EG

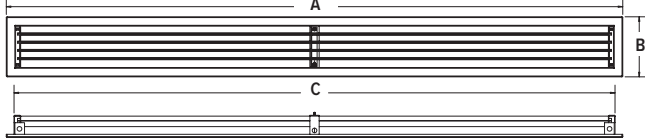

### FRONT/TOP VIEW – VL60EG/VL72EG

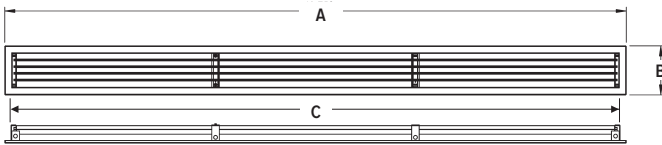

### SIDE VIEW

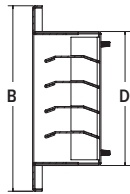

	<b>VL34EG</b>	<b>VL48EG</b>	<b>VL60EG</b>	<b>VL72EG</b>
<b>A</b>	32 5/16"	49 3/4"	61 3/4"	79 3/4"
<b>B</b>	4 3/8"	4 13/16"	4 7/8"	4 7/8"
<b>C</b>	31 3/16"	48 1/2"	60 1/2"	78 5/8"
<b>D</b>	3 1/4"	3 1/2"	3 5/8"	3 5/8"

## SIDE ENCLOSURE GRILL (PAIR)

### FRONT VIEW

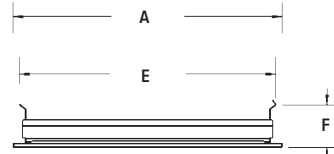
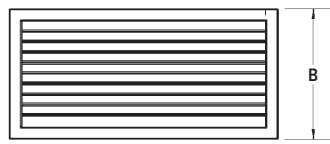

### TOP VIEW

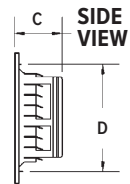

	<b>VL34EGS</b>	<b>VL60EGS</b>	<b>VL72EGS</b>
<b>A</b>	11 1/4"	16 3/16"	16 3/16"
<b>B</b>	6"	7 7/8"	10 3/8"
<b>C</b>	2 5/8"	2 7/8"	2 7/8"
<b>D</b>	4 9/16"	6 7/16"	8 15/16"
<b>E</b>	10 1/2"	15 7/16"	15 7/16"
<b>F</b>	2 7/8"	2 9/16"	2 7/8"



# ENCLAVE ACCESSORIES

## LOG SETS



**MQLOGF34OAK (7-Piece)**  
Oak Log Set  
ENCLAVE 34



**MQLOGF34BW (7-Piece)**  
Birch Log Set  
ENCLAVE 34



**MQ42D (6-Piece)**  
Driftwood Set  
ENCLAVE 34



**MQLOGF453 (5-Piece)**  
Driftwood Set  
ENCLAVE 34



**MQ46D (3-Piece)**  
Driftwood Set  
ENCLAVE 48 / 60 / 72



**MQRBD1 (4-Piece)**  
Driftwood Set with 4 Rocks  
ENCLAVE 48 / 60 / 72



**MQRBD3 (5-Piece) / MQRBD4 (3-Piece)**  
Driftwood Set  
ENCLAVE 34 / 48 / 60 / 72



**MQLOGF48D (6-Piece)**  
Driftwood Set  
ENCLAVE 48 / 60 / 72



**MQRBD2 (3-Piece)**  
Driftwood Set  
ENCLAVE 48 / 60 / 72



**MQRBRW (5-Piece)**  
Birch Log Set  
ENCLAVE 34 / 48 / 60 / 72

MEDIA OPTIONS

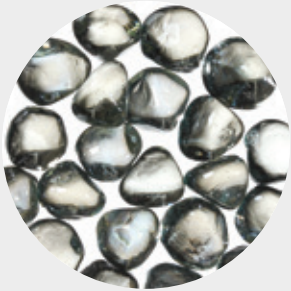

**MQG5ZG**  
Zircon Glacier Ice Glass

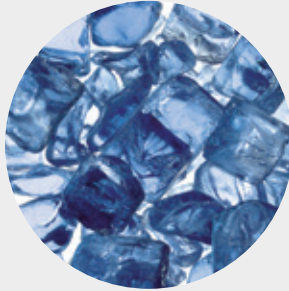

**MQG5A**  
Cobalt Ember Glass

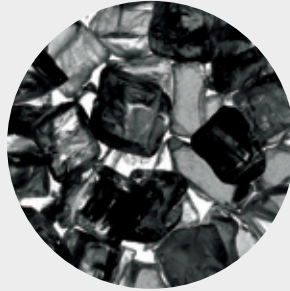

**MQG5B**  
Black Ember Glass

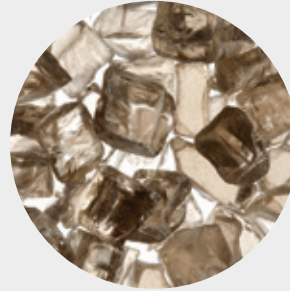

**MQG5C**  
Bronze Ember Glass



**MQG5W**  
White Ember Glass



**MQEMBER**  
Ember Chunks



**MQSTONE**  
Decorative Stones



**MQROCK2**  
Natural Rock Set



**MQROCK3**  
Multi-Colored Rock Set



**RBCB1**  
Multi-Colored Cannonballs

LINERS



**Traditional Brick**  
ENCLAVE 34



**Fluted**  
ENCLAVE 34 / 48 / 60 / 72



**Stacked Brick**  
ENCLAVE 48 / 60 / 72

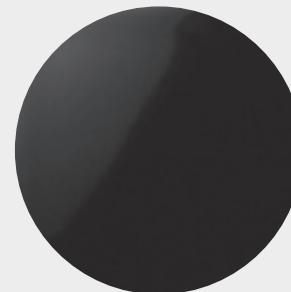

**Glass Reflective**  
ENCLAVE 34 / 48 / 60 / 72



**Unit Illustrated:** Model MQVLBG60NE2 Bay Peninsula Direct Vent Fireplace (Natural Gas), VLBGCK Corner Kit, MQG5C Glass Media (Bronze x3), MQRBD3 Driftwood Log Set, MOSTONE10 Decorative Stone (10 piece), MQVL60RLSB Refractory Liner (Back – Stacked Brick).  
(Chase must be vented below and above appliance – consult manual for instructions).



Marquis Fireplaces maintains a program of continuous testing, refinement and improvements of all its products. Some aspect of units shown here may be changed at any time without notice or obligation.

Certification: Certified to ANSI Z21.88-2017, CSA 2.33-2017 Vented Gas Fireplace Heaters.

Note: Components may have to be ordered separately to create a complete unit. Discuss with your local Marquis Dealer for clarification.

Canada

**ENERGUIDE**

Look for the **EnerGuide** Gas Fireplace Energy Efficiency Rating in this brochure

Based on CSA P.4.1-15



**FOR CALIFORNIA RESIDENTS ONLY:**  
**WARNING!** This product can expose you to chemicals including Carbon Monoxide, that is an externally vented by-product of fuel consumption, which is [are] known to the State of California to cause birth defects or other reproductive harm. For more information, visit [www.P65Warnings.ca.gov](http://www.P65Warnings.ca.gov).

Crafted entirely in Canada, each Marquis fireplace is built to the highest standards and made to last.

**LIMITED LIFETIME WARRANTY**



2340 Logan Avenue  
Winnipeg, Manitoba, CAN  
R2R 2V3  
Phone: 204.632.1962  
Fax: 204.632.1960  
[marquisfireplaces.net](http://marquisfireplaces.net)

Printed in Canada  
B100 – 03/2022