

THE BEAUTY OF SIMPLICITY.



ELEMENT
GAS FIRES



DISTRIBUTED BY:

EuropeanHome



DISCOVER OUR INNOVATIVE, WORLD-CLASS DESIGN FIREPLACES!

Are you looking for a gas fireplace to complement your interior? Or even better: a gas fireplace that is an eye-catcher in your home or office building? Then choose a gas fireplace from Element4, a design fireplace made in the Netherlands, created by design enthusiasts and people with a passion for technology, just like you...

A fireplace that fits you perfectly.

Are you someone who always wants the best? Who gets enthusiastic about products that distinguish themselves from the majority? Then a gas fireplace from Element4 is the right choice for you. Our design team consists of discerning people with passion for design, knowledge of the latest trends and love for special products. You can see that in the end result: a very stylish fireplace that demonstrates the difference between "a beautiful fireplace" and also "contemporary design piece."

DUTCH COMMON SENSE WITH GLOBAL ALLURE

Element4 is a top Dutch brand. We work practically and pragmatically, but with a strong focus on design. This ensures that our fireplaces are loved around the world by designers, architects and trend-conscious consumers. As real 'Dutchies', technology is an important issue for us. Our fireplaces have the most advanced technical features: they are efficient, can be controlled remotely and have an adjustable flame picture. This makes us a real trend-setter on the international market.



CONTENTS

06 CONTROL YOUR FIREPLACE

08 BURNERS

10 LOW SETTING

11 INSTALLATION DEPTH

12 DIRECT VENT SYSTEM

13 POWER VENT

14 FIRE MEDIA

16 INTERIORS & SURROUNDS

18 ACCESSORIES

20 SAFETY BARRIERS

22 PRODUCTS

66 TECHNICAL INFORMATION



26



39



43



49



61

SINGLE-SIDED FIREPLACES 25

- Modore 75H 26
- Modore 95 27
- Summum 70 F 28
- Summum 100 F 29
- Modore 140 30
- Modore 185 31
- Modore 240 32
- Modore 240H 33
- Optica 34
- Sky 35

SEE-THROUGH FIREPLACES 37

- Tenore 100 38
- Tenore 140 39
- Tenore 240 40
- Tenore 240H 41
- Bioptica 42
- Sky T 43

CORNER STYLE FIREPLACES 45

- Bidore 95 47
- Summum 70 C 48
- Summum 100 C 49
- Bidore 140 50
- Bidore 240H 51

THREE-SIDED FIREPLACES 53

- Summum 70 3/S 54
- Summum 100 3/S 55
- Trisore 95 56
- Trisore 140 57

PENINSULA-STYLE FIREPLACES 59

- Lucius 100 60
- Lucius 140 61
- Lucius 240H 63

HOW TO CONTROL YOUR FIREPLACE

E-Save Remote Control: Standard

For maximum comfort, all Element4 Fires are delivered with an intuitive and powerful remote control. This remote allows you to control every aspect of your flame including: flame height, E-Save (Eco settings), multi-burner function, thermostatic mode and so much more.



E-Save Remote

Standard Option



	E-Save Remote Control	Puck	Home Automation Cable	ProControl App
Easy On/Off	●	●	●	●
Manual Flame Adjustment	●	●		●
Child Proof Settings	●			●
Thermostatic Mode	●			●
E-Save (Eco Mode)*	●			●
Multi-Burner Control	●			●
Timer Mode	●			●
Personalized User Profiles				●
LED Burner Control				●
Eco Mode Fuel Savings Data				●
Available on your Smart Device				●
Works with ProControl App	●	●	●	-

*All Element4 fireplaces include E-Save efficiency settings, though these are only controllable via the remote or ProControl App. E-Save settings automatically modulate flame heights, to mimic the appearance of a wood-burning fire and save you up to 45% on fuel consumption.



Puck: Optional

Simple in form and function, the new Puck controls basic functions including turning the fire on and off and adjusting the flame height. The Puck features blue back-lit buttons and is equipped with temperature sensing capabilities when you connect to the ProControl App.



Home Automation Cable: Optional

The Home Automation Cable is for those who already have a home automation system installed. Once you connect your Element4 fireplace to your system, you'll be able to turn your fireplace on or off from your home's centralized control center. The installation is simple and you'll rest assured that your entire smart home, even your fireplace, is connected.

*Home Automation System sold separately.

ProControl App: Optional

Want to easily control your gas fireplace from your smart phone or tablet? This is possible with the intuitively designed ProControl app from Element4. ProControl is the perfect choice if you want to completely control up to 8 fireplaces with the smart device already in your pocket.



PRODUCT-SPECIFIC BURNERS

As you peruse the pages of this catalog you'll notice that every fireplace has a specific burner system. These burners have been specifically designed for their respective models for both performance and aesthetics.

All Element4 burner systems are P.4 Rated (CAN) for optimal efficiency standards.

SINGLE BURNER

The single burner allows for a minimum installation depth of the fireplace and contributes to low fuel consumption. Despite its modest appearance, it has a surprisingly big effect: full, lively flames and a natural fireplace experience.

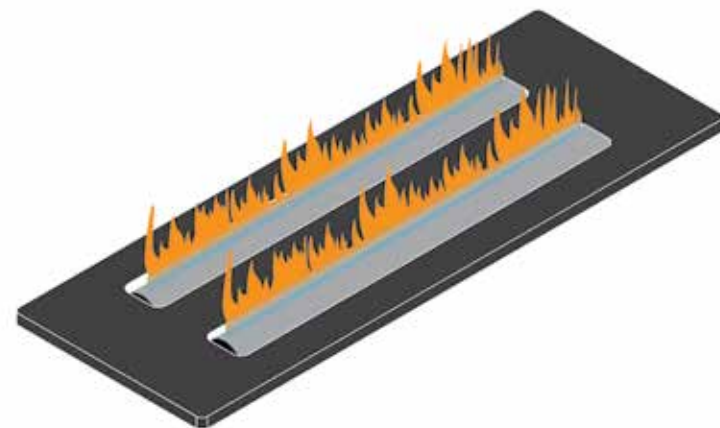
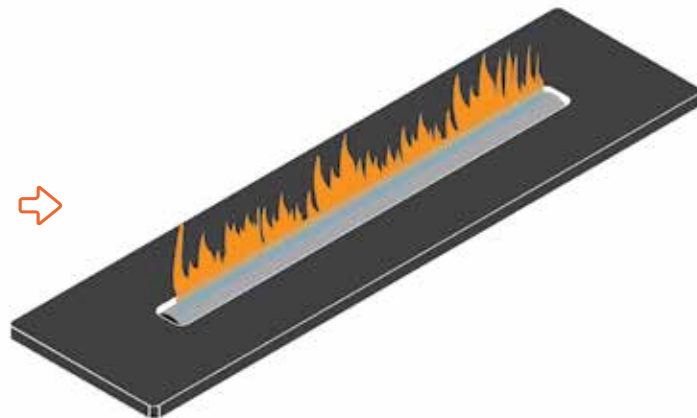

DOUBLE BURNER

The double burner guarantees a beautiful fire experience because the fire is spread over the full depth of the fireplace. In addition, you can easily switch off one of the burners for even more control of the heat and the flame picture.

Enjoy the most beautiful fire at a low setting!

QUAD BURNER

The Quad Burner has five burners and four distinct flame settings so you can drastically adjust the flames and the heat intensity based on your preferences.

Paired with the natural log set fire media, this system creates a truly realistic fire with unmatched depth, controllability and an alluring warmth.

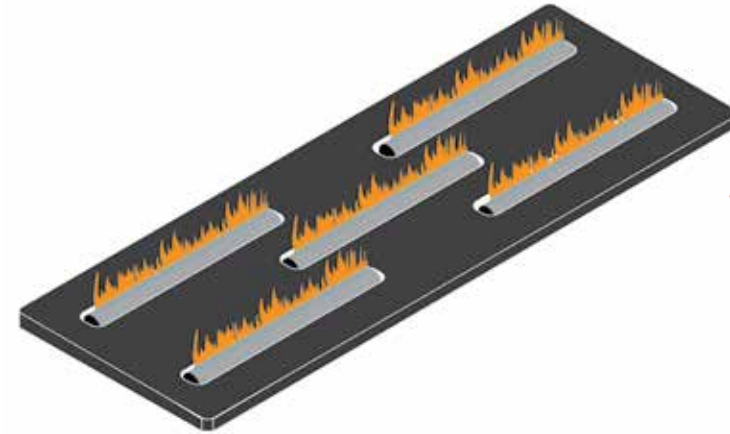

MULTI BURNER

With three staggered burners you benefit from deeper, more robust, flames. Getting a little too warm? Simply switch off the burners to the left and the right to maintain tall beautiful flames for ambiance while cutting down your heat output and fuel consumption up to nearly 70%.

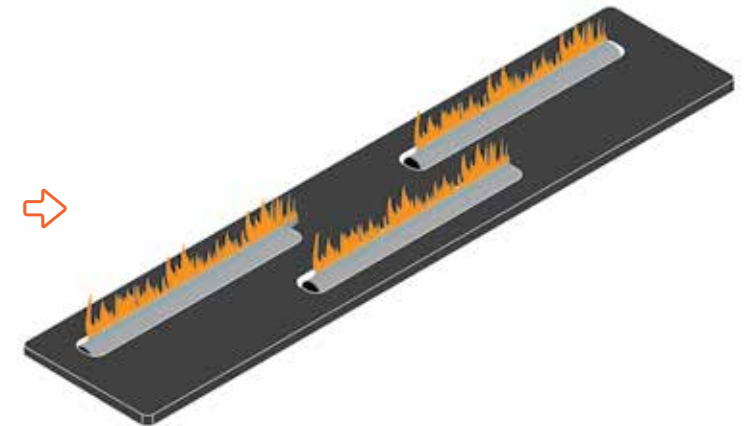

REAL FLAME BURNER

The Real Flame Burner provides the world's most natural looking gas fire. Featuring a special LED lighting effect which create 'glowing embers' and raised burners that wrap the tall flame around expertly crafted logs, it will have you convinced you just sparked up a real wood fire in your living room.

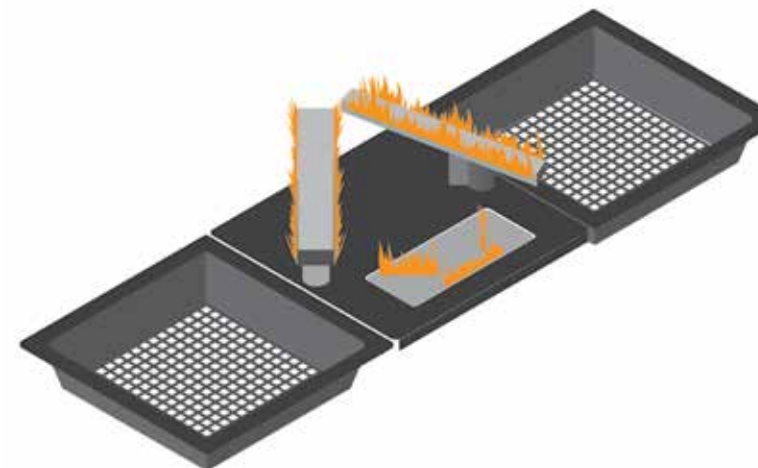

WE PROUDLY PRESENT TO YOU:

THE MOST BEAUTIFUL FIRE AT A LOW SETTING

At Element4 we see it as a challenge to get the most out of our fireplaces. Our aim? Creating a lovely ambiance with a flame picture, regardless of the flame setting. Now you can enjoy a beautiful fire, even with the lowest possible gas consumption. It is no coincidence that we dare to say that a gas fireplace from Element4 "has the most beautiful fire at a low setting".



ELEMENT4 | *Installation depth*

SAVE ROOM THANKS TO THE MINIMAL INSTALLATION DEPTH

Do you have limited amount of space available or do you want a gas fireplace that is as flat as possible to meet your design needs? Then an Element4 fireplace is the right choice for you. Our gas fireplaces are a perfect fit with an installation depth of as little as 14 inches. This is ideal if you have a narrow room or if you also want to install a mantel. Moreover, many designers and architects opt for our shallow fireplaces because of the spatial effect they have on the interior.

DISCOVER THE ADVANTAGES OF OUR DIRECT VENT SYSTEM

The gas fireplaces from Element4 work with a direct vent system. This means that the fireplace is not open to the room, but is completely enclosed. The fresh air and the flue gases run through the same, double-walled pipe that is connected to the outside air. What is the big advantage of a closed system? The flames are always behind the glass. This is safer and ensures heat retention in the balanced flue system, with a higher convection heat and pleasantly warm room as a result. In addition, the supplied cold outside air is already preheated by the double-walled pipe. This ensures a greater efficiency for your gas fireplace.

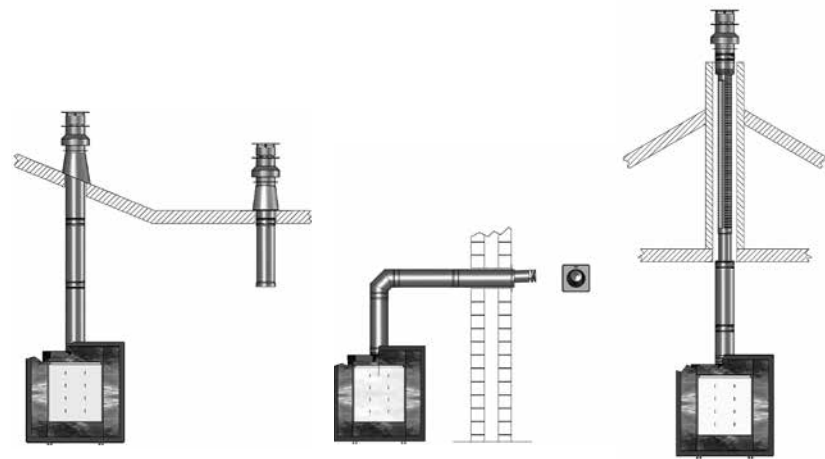

Element4, direct vent, fireplaces can be terminated through the roof or an exterior wall.



WITH THE POWER VENT YOU CAN ENJOY A GAS FIREPLACE ANYWHERE

Want to install your gas fireplace in a place where there is no room for an exhaust pipe? You can do it with the power vent. This smart solution allows you to install your gas fireplace in places where it was previously impossible. And the best part is: the power vent regulates the correct settings for the supply and removal of air.



FIRE MEDIA

Choose from a multitude of natural colors and textures with Element4's fire media options. These materials, designed specifically for gas fireplaces, completely cover the burner and provide a beautiful landscape for your flames.

Fire media choices vary depending on the type of fireplace, please see the technical information section, starting on page 66, for model-specific fire media options.



FOREST PATH



FALLEN BIRCH



BRILLIANTS



LOG SET



CARRARA PEBBLES



TUNDRA



GREY STONES



BLACK QUARTZ

DESIGNER INTERIORS & SURROUNDS

DESIGNER SURROUNDS

Our new interactive digital surround builder allows you to become the fireplace designer. Choose a fireplace size, configuration as well as high quality surround materials to create your ideal composition.



Tenore 140
Featuring a gold and marble surround

1. CHOOSE CONFIGURATION

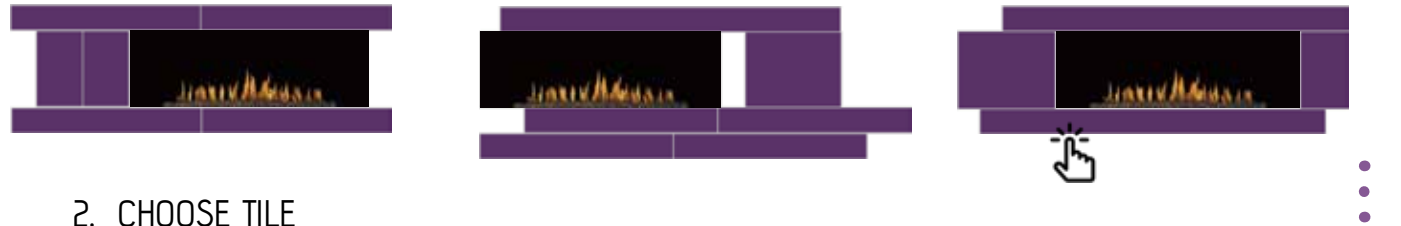

2. CHOOSE TILE



3. CHOOSE METAL

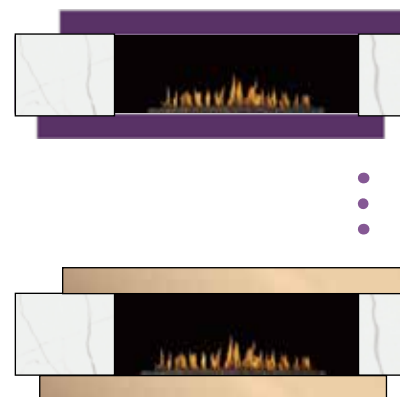
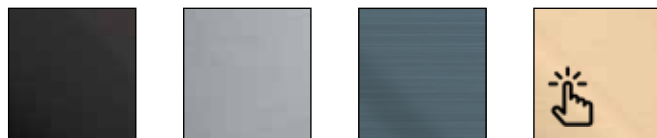

DESIGNER INTERIORS

Element4 offers a multitude of Designer Interiors to suite any design style - the choice is completely up to you.

Designer Interior options vary depending on the type of fireplace. Please see the technical information section, starting on page 66, to see model-specific options.

We offer the following styles and designs:



ANTHRACITE - STANDARD



CONCRETE STYLE



BLACK REFLECTIVE



RUSTIC BRICK

Choose your own style!

Over 200 material combinations to choose from. Design your custom surround today:
www.europeanhome.com/element4-designer-surrounds/

ACCESSORIES

CONVECTION AIR OPENING TRIMS

Convection air opening trims are fitted into the chase to release heated air back into the room. Air openings are required; however, these aesthetic trims are optional. Air opening dimensions vary by model.



Convection Air Opening Trim



Access Door

ACCESS DOOR

This clean and stylish access door allows you to hide away, yet maintain access to, all your important controls and valves. Built-in dimension (H x W) 9-13/16" x 6-15/16" (250 mm x 175 mm).



Tenore 240
Featuring the access door

SAFETY BARRIERS

INVISIMESH VS. GLASS SAFETY BARRIER

By regulation, all fireplaces with a glass front must come with a safety barrier installed to prevent direct contact with hot surfaces. Element4 provides two unique barrier options, both featuring a list of unique benefits and safety features.

INVISIMESH SAFETY SCREEN – STANDARD

Safety screens are installed in front of the fireplace glass to prevent direct contact with hot surfaces. With our extremely fine InvisiMesh screen material you get the benefits of a safety barrier as well as an uninterrupted view of your flames.

The screen does not affect a unit's use or heat output and has been designed specifically for the Element4 units.

ADVANTAGES

- Installs securely in minutes via rare-earth magnets
- Easy to remove
- Near-invisible protection
- No added bulk or extra electricity required



Lucius 140 with Glass Safety Barrier

GLASS SAFETY BARRIER – OPTIONAL

An alternative to the InvisiMesh screen is our Glass Safety Barrier (GSB) system. With this option, air is vented between two glass layers, reducing the heat of the outermost pane. Hot air travels up the chase and is then efficiently distributed into the room, so no heat is lost. This clean and stylish look maximizes the trimless modern lines of your fireplace.

ADVANTAGES

- Clean, trimless lines especially on multi-sided units
- Glass barrier meets safety requirement
- Serviceability (easy to access fans)
- Great option for commercial projects

PRODUCTS

Looking for a contemporary and stylish gas fireplace that highlights your interior?

Discover our versatile gas fireplace collection. From single-sided and see-through fireplaces to peninsula style and 3-sided fireplaces. With a gas fireplace from Element4 you are guaranteed to get intuitive technology and fabulous design. Our gas fireplaces are easy to maintain and have a minimal installation depth starting at just 14 inches. This saves you valuable space. In addition, you benefit from the most beautiful fire at a low setting.





Introduction

SINGLE-SIDED FIREPLACES

The single-sided fireplace is a true classic among gas fireplaces. This type of fireplace allows for completely flush to the wall installations and offers a beautiful view of the fire. You can easily install a single-sided fireplace with a mantel or any number of other design options. Did you know that some Element4 fireplaces require as little as 14" of installation depth? Because of this design feature, you can make optimum use of your space.

Be inspired by our collection and discover which type of fireplace is right for you.







MODORE 95

Ideal for smaller spaces, the Modore 95 is a frameless, direct vent fireplace featuring exceptionally clean lines.

-  Single Burner

-  Heat Output (Natural Gas): 17,050 - 36,200 BTU/hr
Heat Output (LPG): 13,650 - 32,400 BTU/hr
Efficiency: 83%

-  InvisiMesh Safety Barrier: Standard
Glass Safety Barrier: Optional

-  Standard Interior: Anthracite
Optional Interiors: Black Reflective
Concrete Style
Designer Surrounds: Optional

-  E-Save Remote: Standard
App Control (ProControl): Optional
Puck: Optional
Power Vent: Optional
Home Automation Cable: Optional

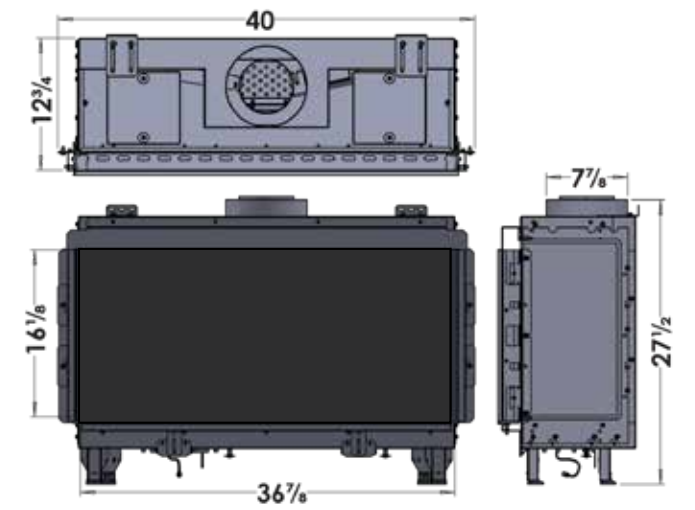

MODORE 75H

Less is more. The Modore 75H takes the proportions of a traditional fireplace and ups the ante with clean lines and a bold, sophisticated style.

-  Double Burner

-  Heat Output (Natural Gas): 14,300 - 46,400 BTU/hr
Heat Output (LPG): 16,000 - 37,000 BTU/hr
Efficiency: 89%

-  InvisiMesh Safety Barrier: Standard

-  Standard Interior: Anthracite
Optional Interiors: Black Reflective
Concrete Style
Rustic Brick

-  E-Save Remote: Standard
App Control (ProControl): Optional
Puck: Optional
Power Vent: Optional
Home Automation Cable: Optional
Anti-Reflect Glass: Standard

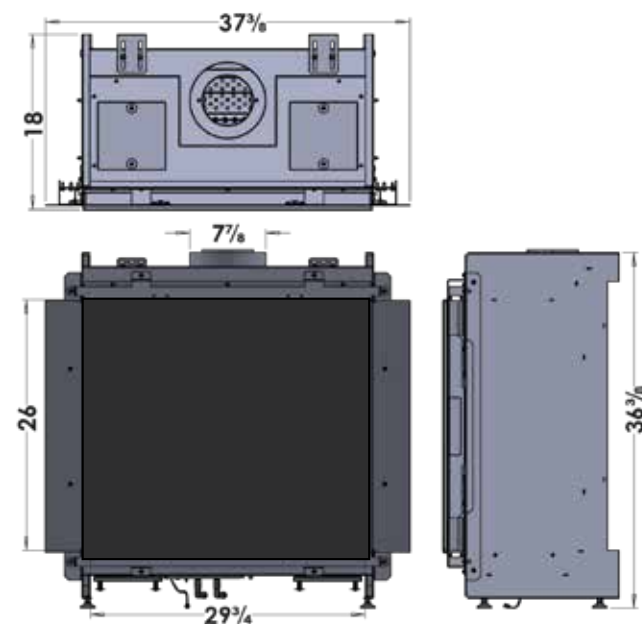

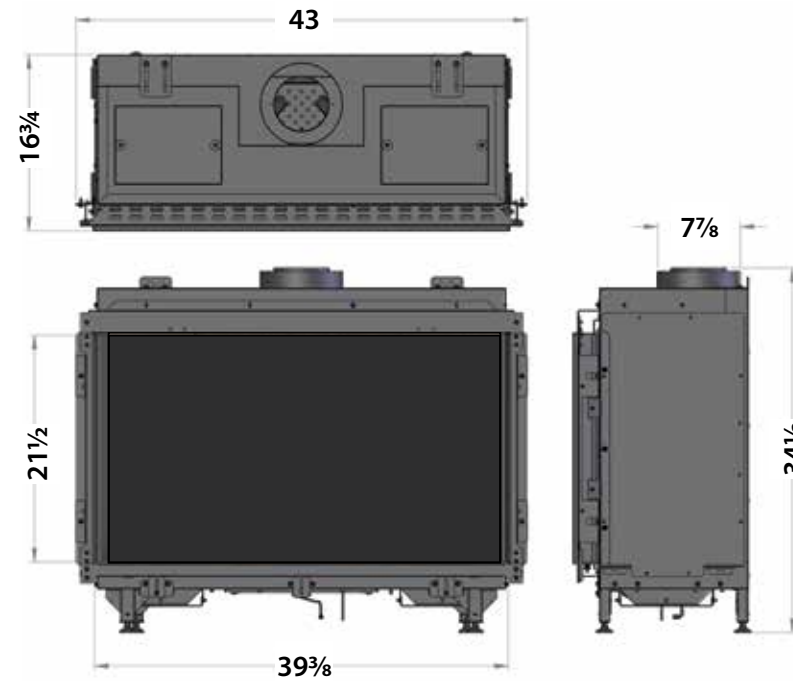

SUMMUM 100 F





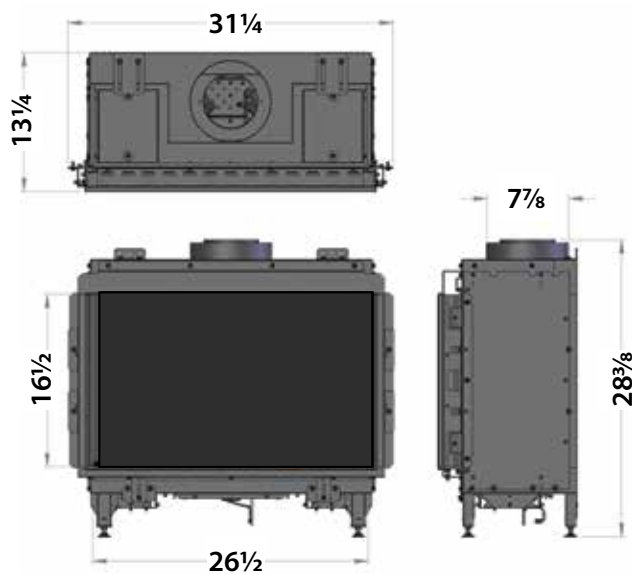

Featuring the most realistic gas flames available today. It's like having a modern campfire in your living room.

-  Real Flame Burner 
-  Heat Output (Natural Gas): 13,000 - 50,000 BTU/hr
Heat Output (LPG): 9,000 - 45,000 BTU/hr
Efficiency: 89%
-  InvisiMesh Safety Barrier: Standard
Glass Safety Barrier: By Request
-  Standard Interior: Anthracite
Optional Interiors: Black Reflective
Concrete Style (by request)
-  E-Save Remote: Standard
App Control (ProControl): Optional
Puck: Optional
Power Vent: Optional
Home Automation Cable: Optional

SUMMUM 70 F

The stylish and sleek Summum 70 F is a perfect complement to any room, pairing elegance with modern style.



-  Real Flame Burner 
-  Heat Output (Natural Gas): 13,376 - 33,439 BTU/hr
Heat Output (LPG): 10,509 - 26,273 BTU/hr
Efficiency: 88%
-  InvisiMesh Safety Barrier: Standard
Glass Safety Barrier: By Request
-  Standard Interior: Anthracite
Optional Interiors: Black Reflective
Concrete Style (by request)
-  E-Save Remote: Standard
App Control (ProControl): Optional
Puck: Optional
Power Vent: Optional
Home Automation Cable: Optional





Pictured with Concrete Style Interior

MODORE 185

Dramatically cozy. Whether you're looking to turn heads or simply turn in with a good book, the Modore 185, at an impressive 6 feet wide, is the perfect focal point for your space.



Multi Burner



Heat Output (Natural Gas): 10,919 - 44,699 BTU/hr
Heat Output (LPG): 9,213 - 46,746 BTU/hr
Efficiency: 90%



InvisiMesh Safety Barrier: Standard
Glass Safety Barrier: Optional



Standard Interior: Anthracite
Optional Interiors: Black Reflective
Concrete Style
Designer Surrounds: Optional



E-Save Remote: Standard
App Control (ProControl): Optional
Puck: Optional
Power Vent: Optional
Home Automation Cable: Optional

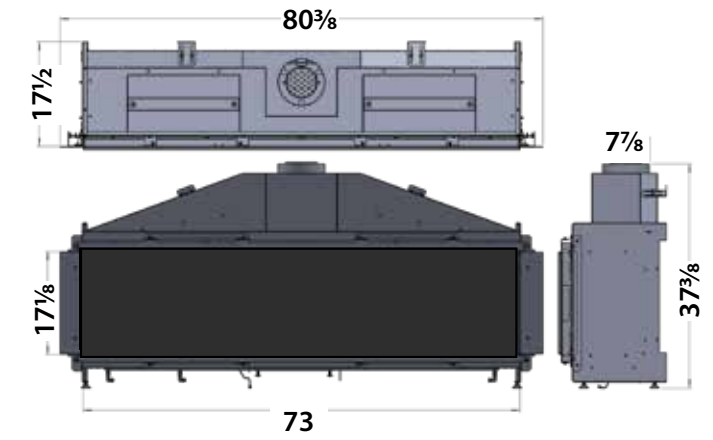

MODORE 140

Perfectly proportioned. The Modore 140 is a direct vent fireplace with a 55" wide viewing area and a stunning flame.



Double or Quad Burner



Double Burner

Heat Output (Natural Gas): 13,650 - 38,200 BTU/hr
Heat Output (LPG): 11,950 - 34,100 BTU/hr



Quad Burner

Heat Output (Natural Gas): 15,000 - 71,000 BTU/hr
Heat Output (LPG): 13,000 - 64,000 BTU/hr
Efficiency: 90%



InvisiMesh Safety Barrier: Standard
Glass Safety Barrier: Optional



Standard Interior: Anthracite
Optional Interiors: Black Reflective
Concrete Style
Designer Surrounds: Optional



E-Save Remote: Standard
App Control (ProControl): Optional
Puck: Optional
Power Vent: Optional
Home Automation Cable: Optional

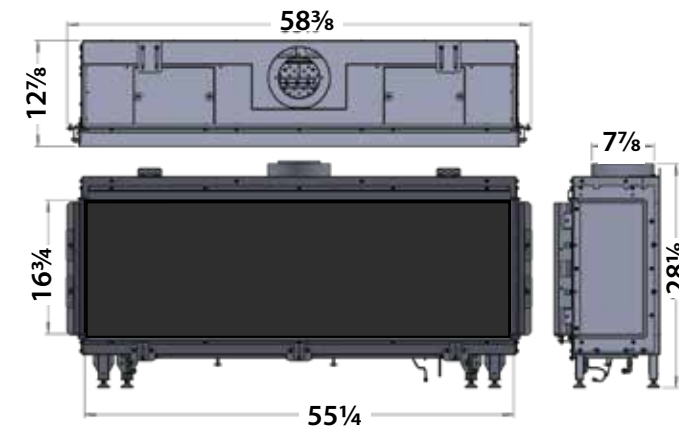

For ideal flames: Pair the Quad Burner with all log-based fire media options and the Double Burner with all others.









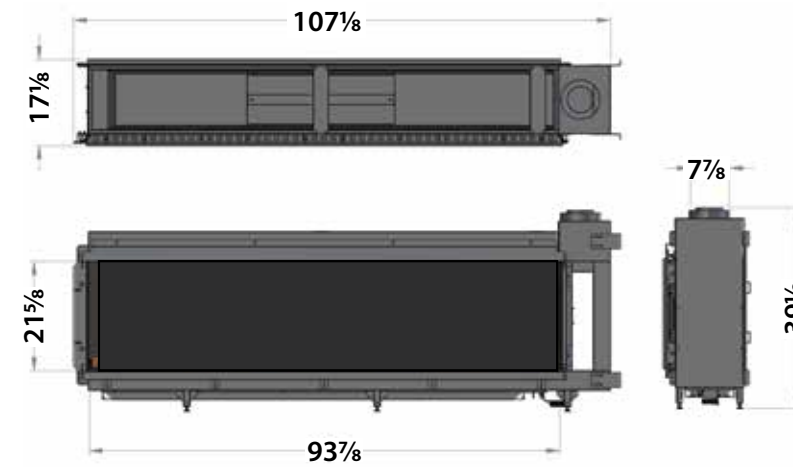

MODORE 240H



Just as wide as the original Modore 240 (nearly 8'), the 240H features a much taller opening (21") for one of the largest and most impressive fireplaces we've ever designed.







-  Multi Burner 

-  Heat Output (Natural Gas): 26,000 - 88,000 BTU/hr
 Heat Output (LPG): 19,500 - 64,800 BTU/hr
 Efficiency: 89%



-  InvisiMesh Safety Barrier: Standard
 Glass Safety Barrier: By Request



-  Standard Interior: Anthracite
 Optional Interiors: Black Reflective
Concrete Style (by request)

-  E-Save Remote: Standard
-  App Control (ProControl): Optional
-  Puck: Optional
-  Power Vent: Optional
-  Home Automation Cable: Optional

MODORE 240





At nearly 8 feet wide, The Modore 240 is a show-stopping linear fireplace designed with substantial homes and commercial projects in mind.

-  Multi Burner 

-  Heat Output (Natural Gas): 26,000 - 88,000 BTU/hr
 Heat Output (LPG): 19,500 - 64,800 BTU/hr
 Efficiency: 89%

-  InvisiMesh Safety Barrier: Standard
 Glass Safety Barrier: Optional

-  Standard Interior: Anthracite
 Optional Interiors: Black Reflective
Concrete Style

-  E-Save Remote: Standard
-  App Control (ProControl): Optional
-  Puck: Optional
-  Power Vent: Optional
-  Home Automation Cable: Optional

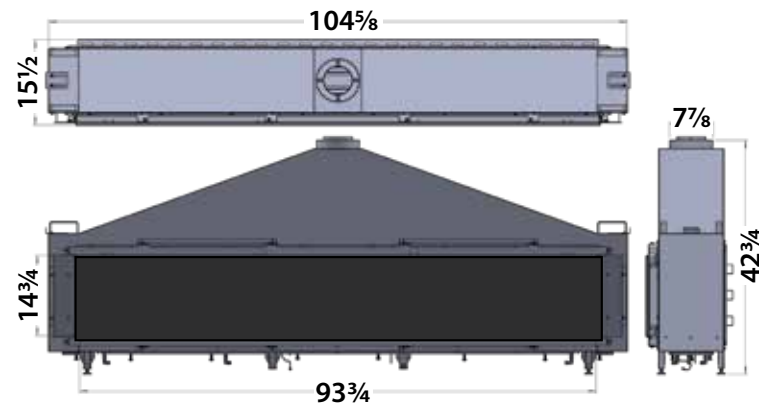

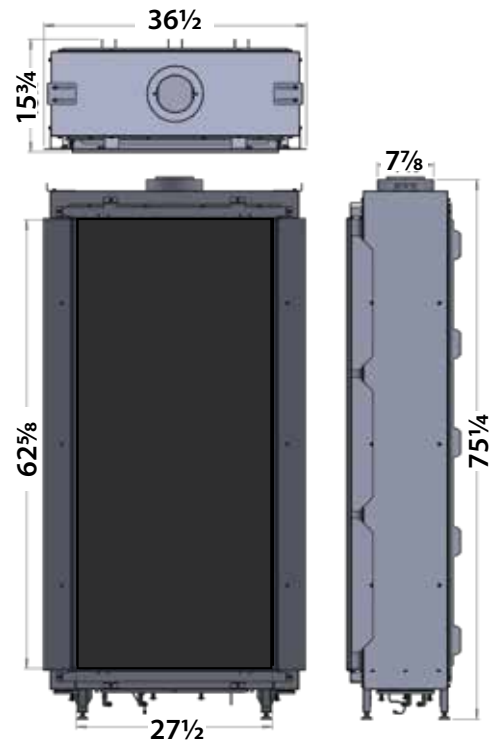

SKY

This vertical gas fireplace reinvents the idea of modern fireplace design and instantly provides a stunning focal point in any sized space.

-  Double Burner

- Heat Output (Natural Gas): 17,000 - 44,000 BTU/hr
- Heat Output (LPG): 11,000 - 36,000 BTU/hr
- Efficiency: 86%

-  InvisiMesh Safety Barrier: Standard

- Standard Interior: Anthracite
- Optional Interiors: Black Reflective

- E-Save Remote: Standard
- App Control (ProControl): Optional
- Puck: Optional
- Power Vent: Optional
- Home Automation Cable: Optional

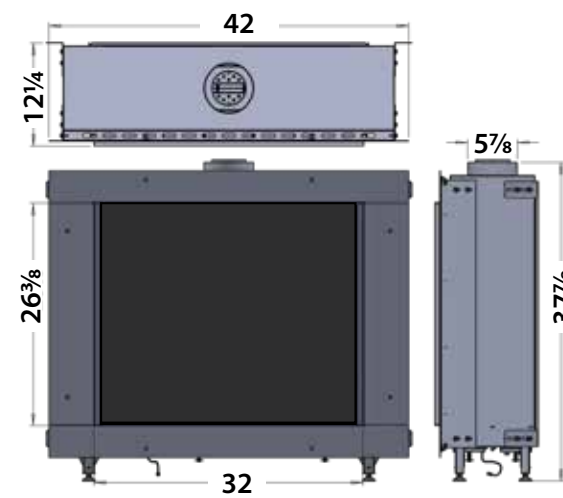

OPTICA

A frameless, built-in direct vent gas fireplace ideal for smaller spaces. The Optica features a traditional-sized opening with a paneled interior.

-  Single Burner

- Heat Output (Natural Gas): 17,070 - 30,730 BTU/hr
- Heat Output (LPG): 8,535 - 26,300 BTU/hr
- Efficiency: 80%

-  InvisiMesh Safety Barrier: Standard

- Standard Interiors: Anthracite

- E-Save Remote: Standard
- App Control (ProControl): Optional
- Puck: Optional
- Power Vent: Optional
- Home Automation Cable: Optional





Introduction

SEE-THROUGH FIREPLACES

Would you prefer a see-through fireplace? Then you are choosing a truly dramatic fireplace design. A see-through fireplace creates an open connection between two rooms, allowing you to enjoy an atmospheric fire in two places at the same time. This is the perfect choice if you are looking for a gas fireplace with a dramatic spatial experience.





TENORE 140

The Tenore 140 is the quintessential see-through linear fireplace. Check out its many features including E-Save which can save up to 40% on fuel consumption.



Double or Quad Burner



Double Burner

Heat Output (Natural Gas): 13,650 - 38,200 BTU/hr

Heat Output (LPG): 11,950 - 34,100 BTU/hr



Quad Burner

Heat Output (Natural Gas): 15,000 - 71,000 BTU/hr

Heat Output (LPG): 13,000 - 64,000 BTU/hr

Efficiency: 90%



InvisiMesh Safety Barrier: Standard

Glass Safety Barrier: Optional



Standard Interior: Anthracite

Optional Interiors: Black Reflective

Concrete Style

Designer Surrounds: Optional



E-Save Remote: Standard

App Control (ProControl): Optional

Puck: Optional

Power Vent: Optional

Home Automation Cable: Optional

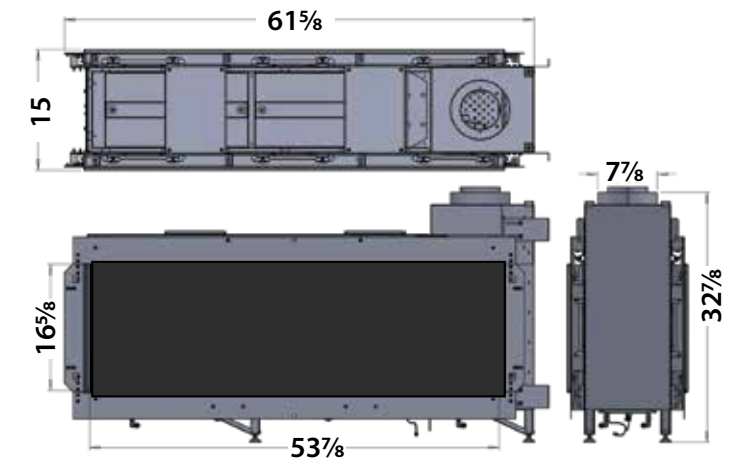

For ideal flames: Pair the Quad Burner with all log-based fire media options and the Double Burner with all others.

TENORE 100

All the stunning drama with exactly the right fit. This two-sided fireplace allows for your installation to have a thoroughly modern and completely trimless finish.



Double Burner



Heat Output (Natural Gas): 22,000 - 59,000 BTU/hr

Heat Output (LPG): 20,500 - 46,000 BTU/hr

Efficiency: 89%



InvisiMesh Safety Barrier: Standard

Glass Safety Barrier: Optional



Standard Interior: Anthracite

Optional Interiors: Black Reflective

Concrete Style



E-Save Remote: Standard

App Control (ProControl): Optional

Puck: Optional

Power Vent: Optional

Home Automation Cable: Optional

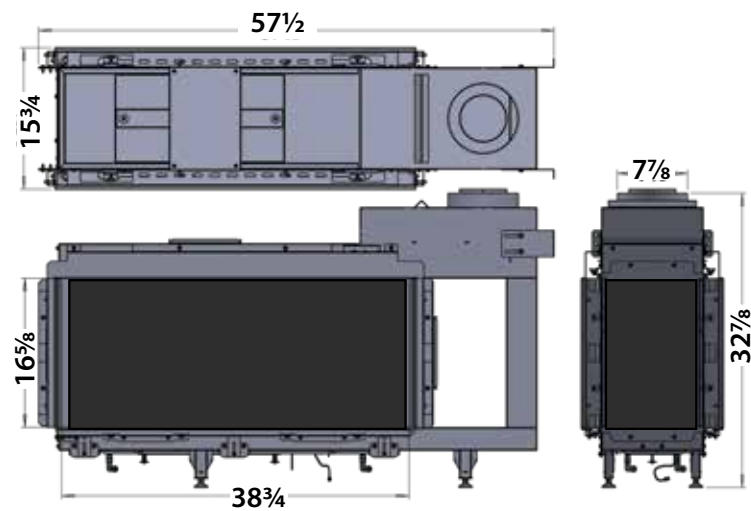







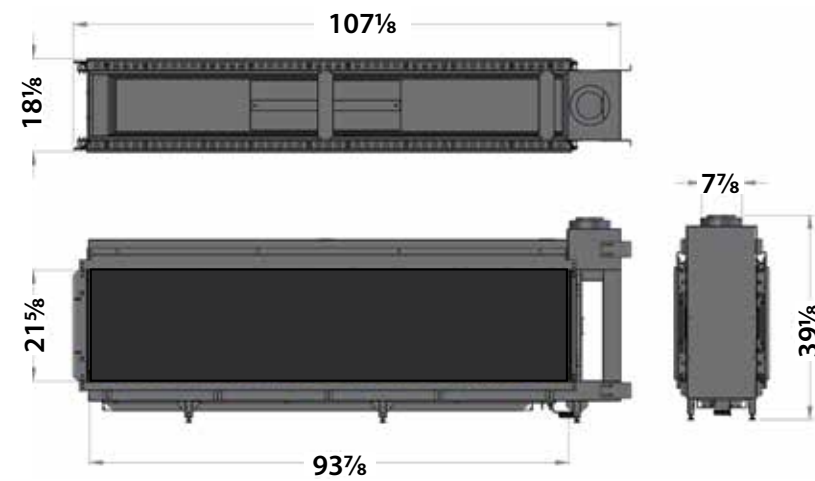

TENORE 240H









Sometimes you just need to make a statement. Featuring a taller viewable opening than the original 240 line and robust flames, this is one of the largest see-through fireplaces around.



-  Multi Burner 
- Heat Output (Natural Gas): 26,000 - 88,000 BTU/hr
- Heat Output (LPG): 19,500 - 64,800 BTU/hr
- Efficiency: 90%
-  InvisiMesh Safety Barrier: Standard
-  Glass Safety Barrier: By Request
-  Standard Interior: Anthracite
-  Optional Interiors: Black Reflective, Concrete Style (by request)
- E-Save Remote: Standard
-  App Control (ProControl): Optional
-  Puck: Optional
- Power Vent: Optional
- Home Automation Cable: Optional

TENORE 240

The Tenore 240 offers all the beauty of the Modore 240, with a see-through design. Same clean lines, same head-turning size.



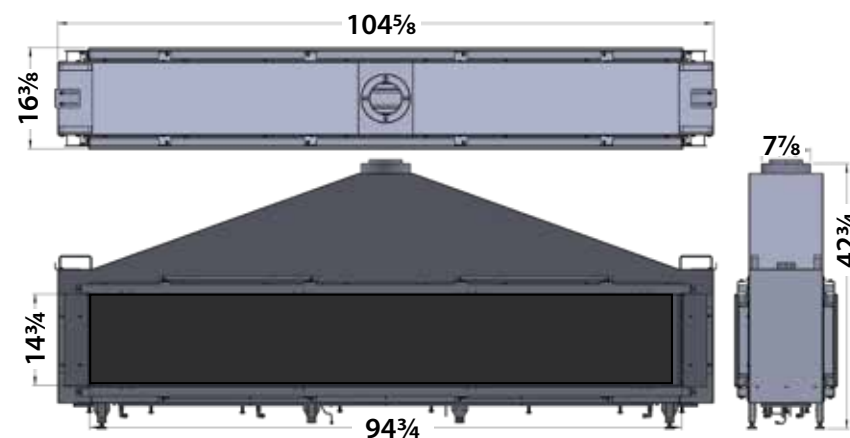

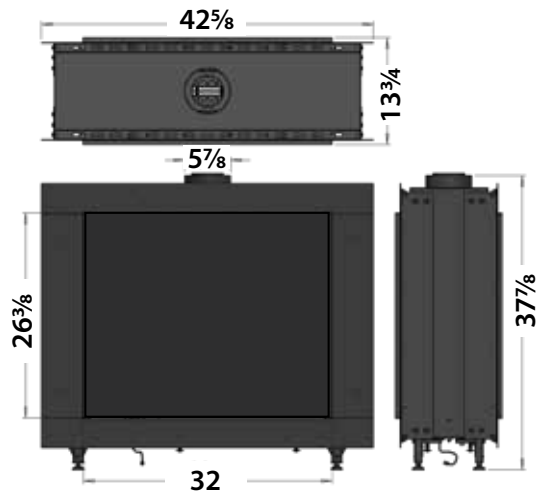



-  Multi Burner 
- Heat Output (Natural Gas): 26,000 - 88,000 BTU/hr
- Heat Output (LPG): 19,500 - 64,800 BTU/hr
- Efficiency: 89%
-  InvisiMesh Safety Barrier: Standard
-  Glass Safety Barrier: Standard
-  Standard Interior: Anthracite
-  Optional Interiors: Black Reflective, Concrete Style
- E-Save Remote: Standard
-  App Control (ProControl): Optional
-  Puck: Optional
- Power Vent: Optional
- Home Automation Cable: Optional





BIOPTICA





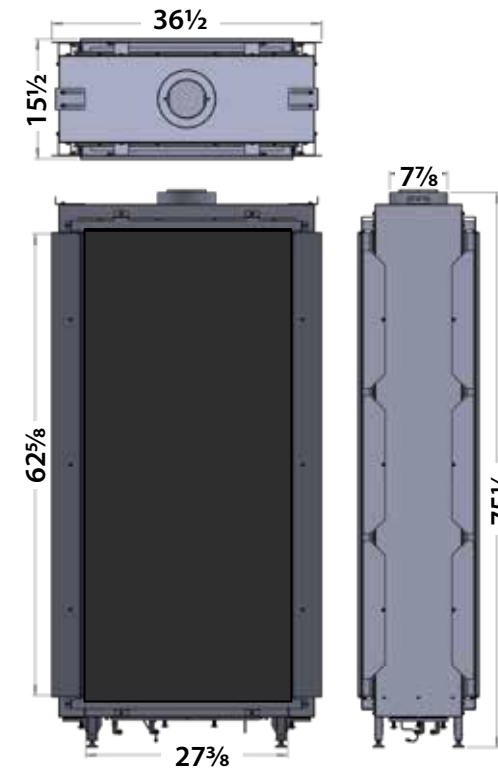



Dramatic and see-through, the Bioptica offers a tall (26") viewable opening. It is a true reflection of Element4's passion for contemporary styling.

-  Single Burner
-  Heat Output (Natural Gas): 17,070 - 30,730 BTU/hr
Heat Output (LPG): 8,535 - 26,300 BTU/hr
Efficiency: 80%
-  InvisiMesh Safety Barrier: Standard
-  Standard Interior: Anthracite
-  E-Save Remote: Standard
-  App Control (ProControl): Optional
-  Puck: Optional
-  Power Vent: Optional
-  Home Automation Cable: Optional



SKY T

The Sky T is a vertical gas fireplace that comes in at an impressive 5 feet tall. Clean lines and a see-through design will bring head-turning drama to your home or commercial space.

-  Double Burner
-  Heat Output (Natural Gas): 17,000 - 44,000 BTU/hr
Heat Output (LPG): 11,000 - 36,000 BTU/hr
Efficiency: 86%
-  InvisiMesh Safety Barrier: Standard
-  Standard Interior: Anthracite
Optional Interiors: Black Reflective
Concrete Style
-  E-Save Remote: Standard
-  App Control (ProControl): Optional
-  Puck: Optional
-  Power Vent: Optional
-  Home Automation Cable: Optional





Introduction

CORNER FIREPLACES







With a corner fireplace you create maximum ambiance in your room. This type of gas fireplace offers a wide view of the robust flames and provides even more atmospheric experience thanks to the extra pane of glass. Element4 offers a choice of various sizes, installation possibilities and capabilities. This way you will always find a corner fireplace that matches your installation situation and interior.

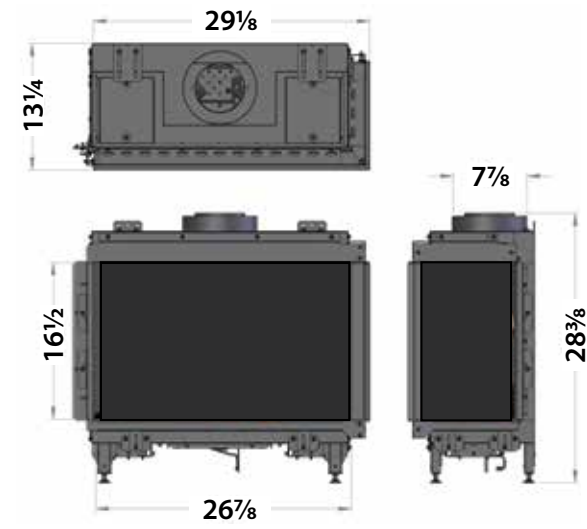

SUMMUM 70 C

You have to see the Real Flame Burner to believe it. Even in this modestly-sized corner fireplace, the drama can truly fill a room.







-  Real Flame Burner 
-  Heat Output (Natural Gas): 13,376 - 33,439 BTU/hr
Heat Output (LPG): 10,509 - 26,273 BTU/hr
Efficiency: 88%
-  InvisiMesh Safety Barrier: Standard
Glass Safety Barrier: By Request
-  Standard Interior: Anthracite
Optional Interiors: Black Reflective
Concrete Style (by request)
-  E-Save Remote: Standard
App Control (ProControl): Optional
Puck: Optional
Power Vent: Optional
Home Automation Cable: Optional



SUMMUM 100 C

The bigger sibling to the 70 C model, this corner fireplace produces lively, robust flames on finely crafted ceramic logs.

-  Real Flame Burner 
-  Heat Output (Natural Gas): 13,000 - 50,000 BTU/hr
Heat Output (LPG): 9,000 - 45,000 BTU/hr
Efficiency: 89%
-  InvisiMesh Safety Barrier: Standard
Glass Safety Barrier: By Request
-  Standard Interior: Anthracite
Optional Interiors: Black Reflective
Concrete Style (by request)
-  E-Save Remote: Standard
App Control (ProControl): Optional
Puck: Optional
Power Vent: Optional
Home Automation Cable: Optional

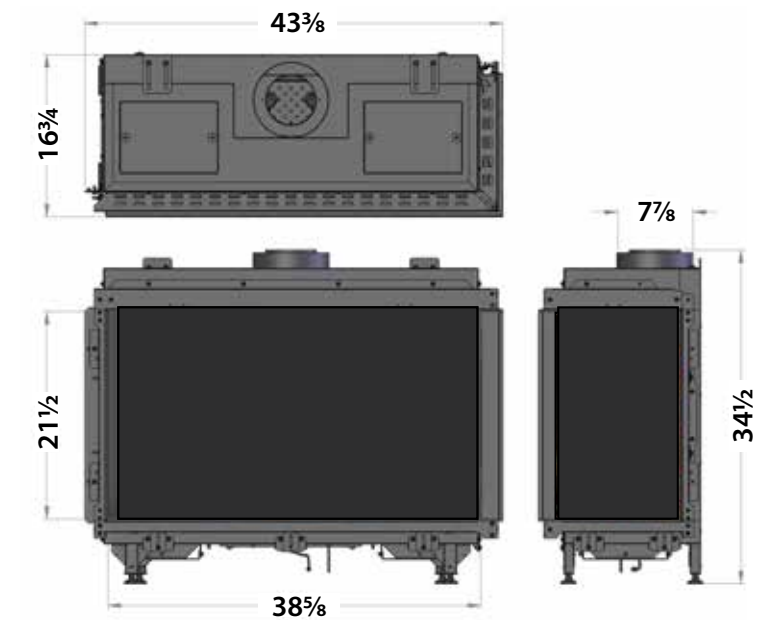

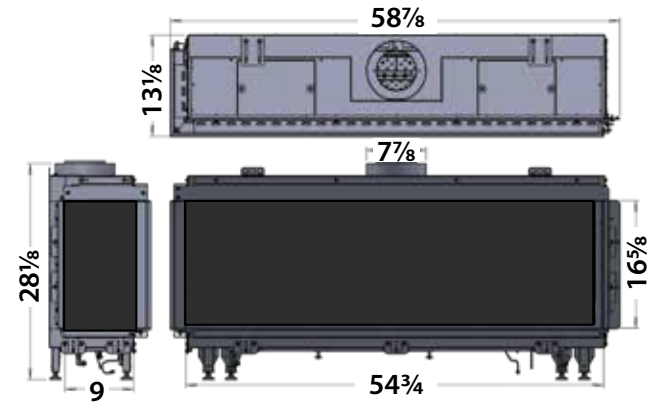





For ideal flames: Pair the Quad Burner with all log-based fire media options and the Double Burner with all others.

BIDORE 140

With its clean glass on glass corner this fireplace references Modernist architectural icons such as Le Corbusier.

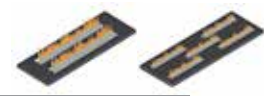

-  Double or Quad Burner
 - Double Burner**
 - Heat Output (Natural Gas): 13,650 - 38,200 BTU/hr
 - Heat Output (LPG): 11,950 - 34,100 BTU/hr
 - Quad Burner**
 - Heat Output (Natural Gas): 15,000 - 71,000 BTU/hr
 - Heat Output (LPG): 13,000 - 64,000 BTU/hr
 - Efficiency: 90%
-  InvisiMesh Safety Barrier: Standard
Glass Safety Barrier: Optional
-  Standard Interior: Anthracite
Optional Interiors: Black Reflective, Concrete Style
-  E-Save Remote: Standard
App Control (ProControl): Optional
Puck: Optional
Power Vent: Optional
Home Automation Cable: Optional



Left-Corner Unit Pictured

BIDORE 240H

Asymmetry. Scale. Glass. Fire. The minimalist's approach says you don't have to say much, but if you do say something, pronounce it exceptionally well.

-  Multi Burner
 - Heat Output (Natural Gas): 26,000 - 88,000 BTU/hr
 - Heat Output (LPG): 19,500 - 64,800 BTU/hr
 - Efficiency: 89%
-  InvisiMesh Safety Barrier: Standard
Glass Safety Barrier: By Request
-  Standard Interior: Anthracite
Optional Interiors: Black Reflective, Concrete Style (by request)
-  E-Save Remote: Standard
App Control (ProControl): Optional
Puck: Optional
Power Vent: Optional
Home Automation Cable: Optional

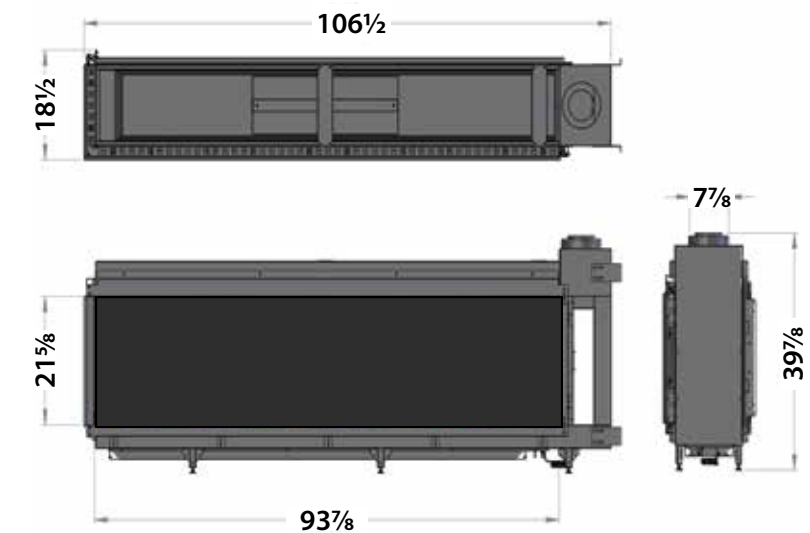



Introduction

3-SIDED FIREPLACES



The 3-sided gas fireplace gives you a view of the fire from multiple angles. Thanks to the use of multiple glass panes, you can use this fireplace in many creative ways within your interior. Element4 offers a suitable model for every taste and style, available in various sizes. Be inspired by the collection and find the 3-sided gas fireplace that best suits you.







SUMMUM 100 3/S

39" Wide. 21" Tall. 3 panes of modern glass between the most perfect fire and your favorite lounge chair.

-  Real Flame Burner 

- Heat Output (Natural Gas): 13,000 - 50,000 BTU/hr
Heat Output (LPG): 9,000 - 45,000 BTU/hr
Efficiency: 89%

-  InvisiMesh Safety Barrier: Standard
Glass Safety Barrier: By Request

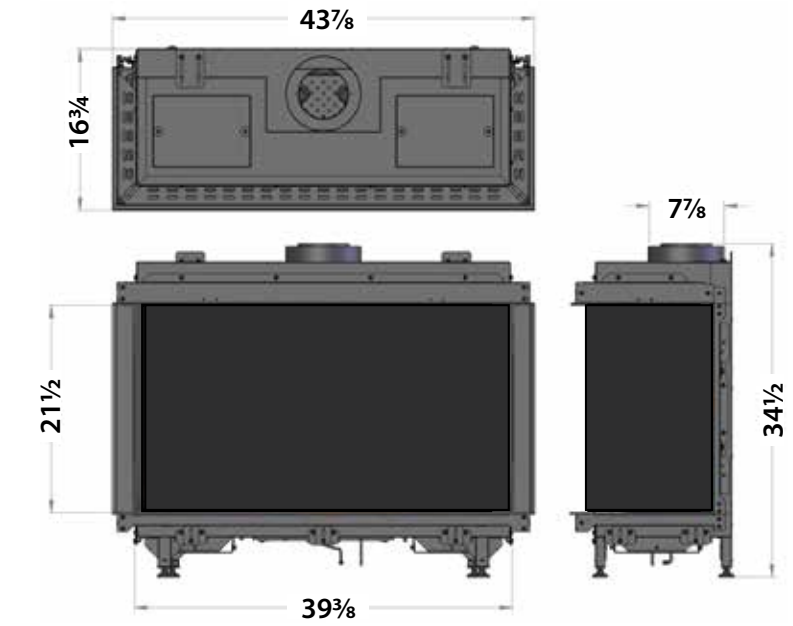

-  Standard Interior: Anthracite
Optional Interiors: Black Reflective
Concrete Style (by request)

-  E-Save Remote: Standard
App Control (ProControl): Optional
Puck: Optional
Power Vent: Optional
Home Automation Cable: Optional





SUMMUM 70 3/S

Clean glass corners, highly efficient, optional app control and the world's most natural gas flames. What's not to love?

-  Real Flame Burner 

- Heat Output (Natural Gas): 13,376 - 33,439 BTU/hr
Heat Output (LPG): 10,509 - 26,273 BTU/hr
Efficiency: 88%

-  InvisiMesh Safety Barrier: Standard
Glass Safety Barrier: By Request

-  Standard Interior: Anthracite
Optional Interiors: Black Reflective
Concrete Style (by request)

-  E-Save Remote: Standard
App Control (ProControl): Optional
Puck: Optional
Power Vent: Optional
Home Automation Cable: Optional

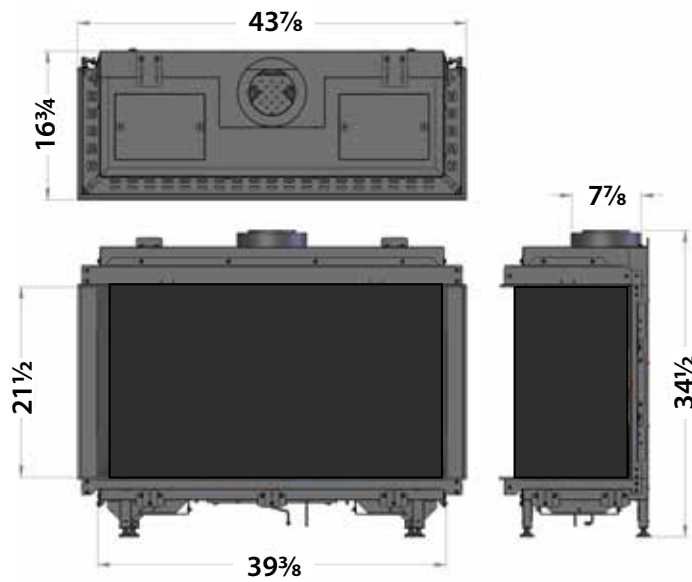

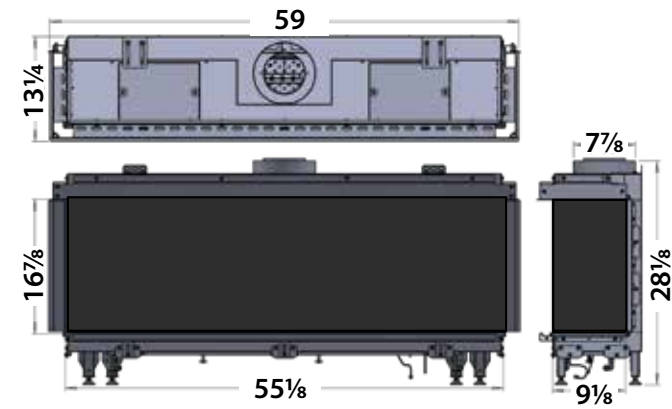

For ideal flames: Pair the Quad Burner with all log-based fire media options and the Double Burner with all others.

TRISORE 140

A three-sided, or bay-style fireplace, the Trisore 140 features two seamless glass on glass corners; the perfect embodiment of clean European design.



Double or Quad Burner



Double Burner

Heat Output (Natural Gas): 13,650 - 38,200 BTU/hr
Heat Output (LPG): 11,950 - 34,100 BTU/hr



Quad Burner

Heat Output (Natural Gas): 15,000 - 71,000 BTU/hr
Heat Output (LPG): 13,000 - 64,000 BTU/hr
Efficiency: 90%



InvisiMesh Safety Barrier: Standard
Glass Safety Barrier: Optional



Standard Interior: Anthracite
Optional Interiors: Black Reflective
Concrete Style



E-Save Remote: Standard
App Control (ProControl): Optional
Puck: Optional
Power Vent: Optional
Home Automation Cable: Optional

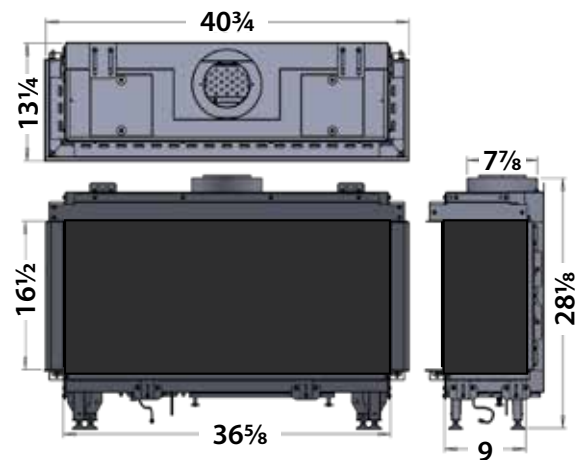

TRISORE 95

Proportioned for smaller spaces with plenty of drama to spare. The Trisore 95 features a beautiful design and fuel efficient settings to ensure an Eco-friendly experience.



Single Burner



Heat Output (Natural Gas): 17,050 - 36,200 BTU/hr
Heat Output (LPG): 13,650 - 32,400 BTU/hr
Efficiency: 83%



InvisiMesh Safety Barrier: Standard
Glass Safety Barrier: Optional



Standard Interior: Anthracite
Optional Interiors: Black Reflective
Concrete Style



E-Save Remote: Standard
App Control (ProControl): Optional
Puck: Optional
Power Vent: Optional
Home Automation Cable: Optional





Introduction

PENINSULA STYLE





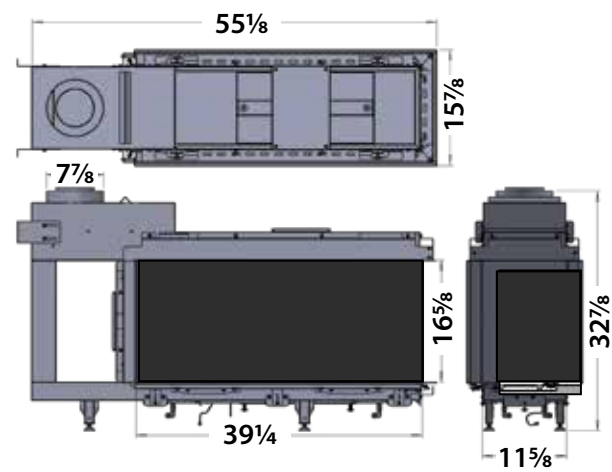



Choose a peninsula style gas fireplace and create a stylish separation between two different spaces. Thanks to the tall glass pane, you can view the beautifully natural flames from several positions. As an added benefit, you will enjoy the efficient warmth from your fireplace in both spaces. Peninsula style fireplaces can be installed floating or in a wall. Discover our collection of peninsula style fireplaces and be inspired by the ambiance they create.





LUCIUS 100











The Lucius 100 room divider is a stunning, frameless peninsula fireplace featuring an unobstructed view of your flames on three sides.

-  Double Burner
-  Heat Output (Natural Gas): 22,000 - 59,000 BTU/hr
Heat Output (LPG): 20,500 - 46,000 BTU/hr
Efficiency: 89%
-  InvisiMesh Safety Barrier: Standard
Glass Safety Barrier: Optional
-  Standard Interior: Anthracite
Optional Interiors: Black Reflective
Concrete Style
-  E-Save Remote: Standard
-  App Control (ProControl): Optional
-  Puck: Optional
-  Power Vent: Optional
-  Home Automation Cable: Optional



LUCIUS 140

Perfect for open floor plans. This fireplace divides space in an ingenious way so that you may see its flickering flames from nearly anywhere.

-  Double or Quad Burner
-  **Double Burner**
Heat Output (Natural Gas): 13,650 - 38,200 BTU/hr
Heat Output (LPG): 11,950 - 34,100 BTU/hr
-  **Quad Burner**
Heat Output (Natural Gas): 15,000 - 71,000 BTU/hr
Heat Output (LPG): 13,000 - 64,000 BTU/hr
Efficiency: 90%
-  InvisiMesh Safety Barrier: Standard
Glass Safety Barrier: Optional
-  Standard Interior: Anthracite
Optional Interiors: Black Reflective
Concrete Style
-  E-Save Remote: Standard
-  App Control (ProControl): Optional
-  Puck: Optional
-  Power Vent: Optional
-  Home Automation Cable: Optional

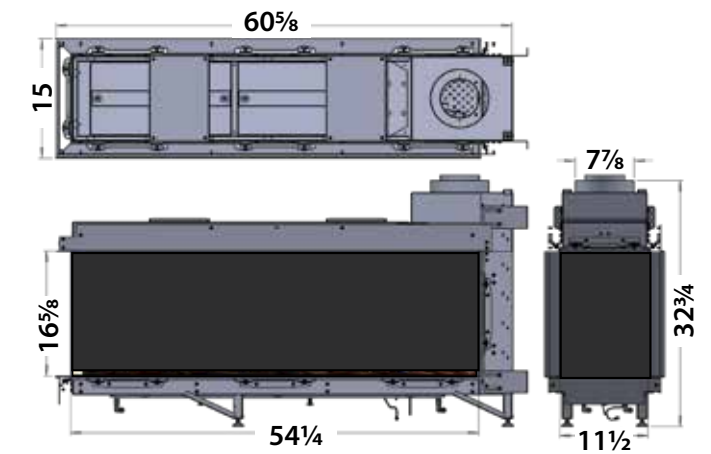

For ideal flames: Pair the Quad Burner with all log-based fire media options and the Double Burner with all others.



LUCIUS 240H

Nearly 8' wide this peninsula style fireplace is the perfect combination of form and function. Beautiful, efficient, and an ingenious way to divide a large space.



Multi Burner



Heat Output (Natural Gas): 26,000 - 88,000 BTU/hr
 Heat Output (LPG): 19,500 - 64,800 BTU/hr
 Efficiency: 89%



InvisiMesh Safety Barrier: Standard
 Glass Safety Barrier: By Request



Standard Interior: Anthracite
 Optional Interiors: Black Reflective
 Concrete Style (by request)



E-Save Remote: Standard
 App Control (ProControl): Optional
 Puck: Optional
 Power Vent: Optional
 Home Automation Cable: Optional

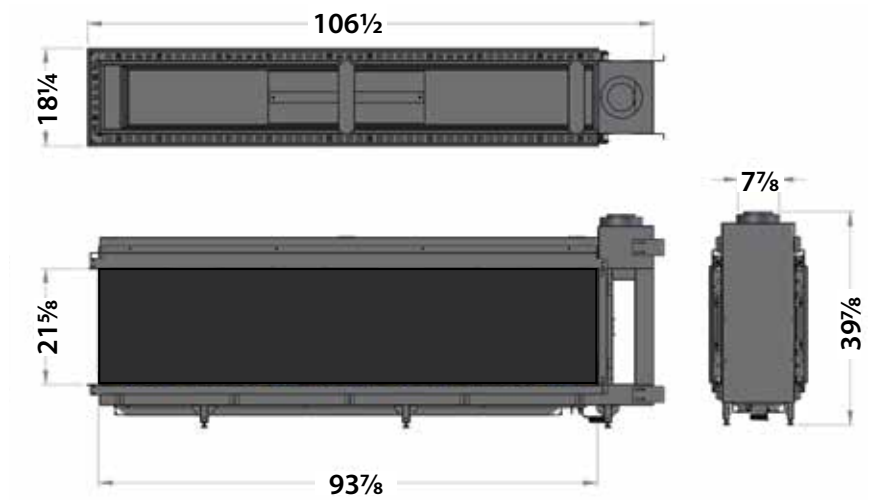

Great for commercial projects too!





	<i>BIDORE 95</i>	<i>BIDORE 140</i>	<i>BIDORE 240H</i>	<i>BIOPTICA</i>	<i>LUCIUS 100</i>	<i>LUCIUS 140</i>	<i>LUCIUS 240H</i>	<i>MODORE 75H</i>	<i>MODORE 95</i>	<i>MODORE 140</i>
Burner	Single	Dub/Quad	Multi	Single	Double	Dub/Quad	Multi	Double	Single	Dub/Quad
Natural Gas	●	●	●	●	●	●	●	●	●	●
Propane	●	●	●	●	●	●	●	●	●	●
Heat Input Natural Gas (Btu/hr)	17,050	15,000	26,000	17,070	22,000	15,000	26,000	14,300	17,050	15,000
Min.-Max.	36,200	71,000	88,000	30,730	59,000	71,000	88,000	46,400	36,200	71,000
Heat Input LPG (Btu/hr)	13,650	13,000	19,500	8,535	20,500	13,000	19,500	16,000	13,650	13,000
Min. - Max.	32,400	64,000	64,800	26,300	46,000	64,000	64,800	37,000	32,400	64,000
Efficiency	83%	90%	89%	80%	89%	90%	89%	89%	83%	90%
INTERIORS										
Anthracite	●	●	●	●	●	●	●	●	●	●
Reflective Black	○	○	○	-	○	○	○	○	○	○
Concrete Style	○	○	○	-	○	○	○	○	○	○
Rustic Brick	-	-	-	-	-	-	-	○	-	-
FIRE MEDIA										
Log Set	○	○	○	○	○	○	○	○	○	○
Forest Path	○	○	○	○	○	○	○	○	○	○
Fallen Birch	○	○	○	○	○	○	○	○	○	○
Tundra	○	○	○	○	○	○	○	-	○	○
White Carrara Pebbles	○	○	○	○	○	○	○	-	○	○
Brilliants	○	○	○	○	○	○	○	-	○	○
Black Quartz	○	○	○	○	○	○	○	-	○	○
Grey Stones	○	○	○	○	○	○	○	-	○	○
E-Save Remote	●	●	●	●	●	●	●	●	●	●
ProControl via app	○	○	○	○	○	○	○	○	○	○
Direct Vent size Ø (in./in.)	5/8	5/8	5/8	4/6	5/8	5/8	5/8	5/8	5/8	5/8
Power Vent	○	○	○	○	○	○	○	○	○	○

● = standard ○ = optional



	<i>MODORE 185</i>	<i>MODORE 240</i>	<i>MODORE 240H</i>	<i>OPTICA</i>	<i>SKY</i>	<i>SKY T</i>	<i>SUMMUM 70 3/S</i>	<i>SUMMUM 70 C</i>	<i>SUMMUM 70 F</i>
Burner	Multi	Multi	Multi	Single	Double	Double	Real Flame	Real Flame	Real Flame
Natural Gas	●	●	●	●	●	●	●	●	●
Propane	●	●	●	●	●	●	●	●	●
Heat Input Natural Gas (Btu/hr)	10,919	26,000	26,000	17,070	17,000	17,000	13,376	13,376	13,376
Min.-Max.	44,699	88,000	88,000	30,730	44,000	44,000	33,439	33,439	33,439
Heat Input LPG (Btu/hr)	9,213	19,500	19,500	8,535	11,000	11,000	10,509	10,509	10,509
Min. - Max.	46,746	64,800	64,800	26,300	36,000	36,000	26,273	26,273	26,273
Efficiency	90%	89%	89%	80%	86%	86%	88%	88%	88%
INTERIORS									
Anthracite	●	●	●	●	●	●	●	●	●
Reflective Black	○	○	○	-	○	○	○	○	○
Concrete Style	○	○	○	-	○	○	○	○	○
Rustic Brick	-	-	-	-	-	-	-	-	-
FIRE MEDIA									
Log Set	○	○	○	○	○	○	○	○	○
Forest Path	○	○	○	○	○	○	-	-	-
Fallen Birch	○	○	○	○	○	○	-	-	-
Tundra	○	○	○	○	○	○	-	-	-
White Carrara Pebbles	○	○	○	○	○	○	-	-	-
Brilliants	○	○	○	○	○	○	-	-	-
Black Quartz	○	○	○	○	○	○	-	-	-
Grey Stones	○	○	○	○	○	○	-	-	-
E-Save Remote	●	●	●	●	●	●	●	●	●
ProControl via app	○	○	○	○	○	○	○	○	○
Direct Vent size Ø (in./in.)	5/8	5/8	5/8	4/6	5/8	5/8	5/8	5/8	5/8
Power Vent	○	○	○	○	○	○	○	○	○

● = standard ○ = optional



	<i>SUMMUM 100 3/S</i>	<i>SUMMUM 100 C</i>	<i>SUMMUM 100 F</i>	<i>TENORE 100</i>	<i>TENORE 140</i>	<i>TENORE 240</i>	<i>TENORE 240H</i>	<i>TRISORE 95</i>	<i>TRISORE 140</i>
Burner	Real Flame	Real Flame	Real Flame	Double	Dub/Quad	Multi	Multi	Double	Dub/Quad
Natural Gas	●	●	●	●	●	●	●	●	●
Propane	●	●	●	●	●	●	●	●	●
Heat Input Natural Gas (Btu/hr)	13,000	13,000	13,000	22,000	15,000	26,000	26,000	17,050	15,000
Min.-Max.	50,000	50,000	50,000	59,000	71,000	88,000	88,000	36,200	71,000
Heat Input LPG (Btu/hr)	9,000	9,000	9,000	20,500	13,000	19,500	19,500	13,650	13,000
Min. - Max.	45,000	45,000	45,000	46,000	64,000	64,800	64,800	32,400	64,000
Efficiency	89%	89%	89%	89%	90%	89%	89%	83%	90%
INTERIORS									
Anthracite	●	●	●	●	●	●	●	●	●
Reflective Black	○	○	○	○	○	○	○	○	○
Concrete Style	○	○	○	○	○	○	○	○	○
Rustic Brick	-	-	-	-	-	-	-	-	-
FIRE MEDIA									
Log Set	○	○	○	○	○	○	○	○	○
Forest Path	-	-	-	○	○	○	○	○	○
Fallen Birch	-	-	-	○	○	○	○	○	○
Tundra	-	-	-	○	○	○	○	○	○
White Carrara Pebbles	-	-	-	○	○	○	○	○	○
Brilliants	-	-	-	○	○	○	○	○	○
Black Quartz	-	-	-	○	○	○	○	○	○
Grey Stones	-	-	-	○	○	○	○	○	○
E-Save Remote	●	●	●	●	●	●	●	●	●
ProControl via app	○	○	○	○	○	○	○	○	○
Direct Vent size Ø (in./in.)	5/8	5/8	5/8	5/8	5/8	5/8	5/8	5/8	5/8
Power Vent	○	○	○	○	○	○	○	○	○

● = standard ○ = optional



www.europeanhome.com
info@europeanhome.com
781.324.8383

Find Your Local Dealer Today:



You can also visit:
www.europeanhome.com/dealer

Intertek, a nationally recognized testing laboratory (NRTL), has certified that the Element4 fireplaces imported by European Home meet the North American standards (ANSI Z21.50a, CSA 2.22a) for direct-vent appliances.

These direct-vent appliances are approved for use by all current North American building codes including California, Florida and New York state building codes.



2019 - 2.7