

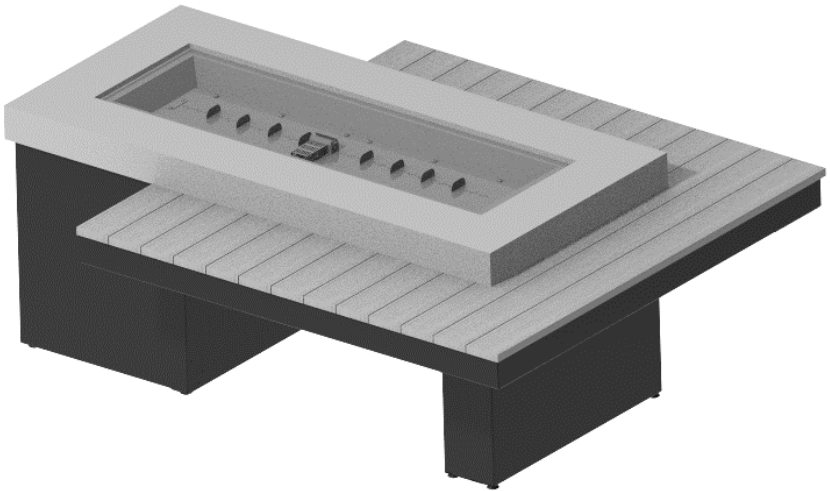

the **outdoor**  
**greatroom**  
company

## Uptown Fire Pit Table

Installation Instructions for:  
UPT-1242-AMH  
UPT-1242-CGR  
UPT-1242-SHL



# Contents

|  |    |
|--|----|
| Required Tools.....                        | 2  |
| Placing and assembling the Fire Table..... | 3  |
| Sparker Installation.....                  | 6  |
| Gas Connections.....                       | 6  |
| Thermocouple Connection.....               | 7  |
| Sparker Connection.....                    | 7  |
| Locating Propane tank.....                 | 8  |
| Locating Natual Gas Line.....              | 9  |
| Care and Maintenance.....                  | 9  |
| Fire Media Installation.....               | 10 |
| Warranty Information.....                  | 11 |
| Service Parts .....                        | 12 |

## Required Tools



- **Utility Knife** - *To cut and remove packaging.*



- **Phillips Screwdriver** – *To attach support base to top.*



- **Leather Gloves** - *To protect hands from rough edges found on the coffee table.*



- **One (1) AAA Battery (not included)** - *Required for piezoelectric igniter installation.*



- Do not attempt to perform installation by yourself. This fire pit table is constructed of steel and heavy stone products. Have at least one other person help you.

## Placing and Assembling the Fire Table

1. Remove all components from packaging.
2. Move the base sections to desired location and set into place spaced approximately 28 ½" from each other.
3. When locating your table, refer to the Crystal Fire® Plus manual and maintain clearance to combustibles.

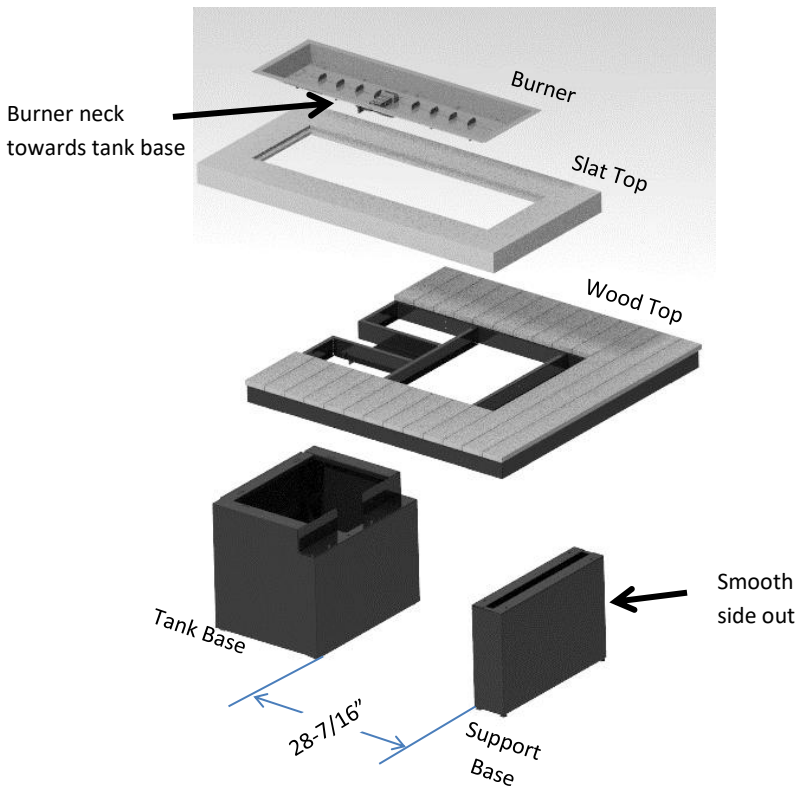

4. Place tank base in desired location, then adjust leveling legs on bottom to ensure tank door operates smoothly.
5. Use Phillips screwdriver and supplied bolts (6) to attach wood top to tank base.

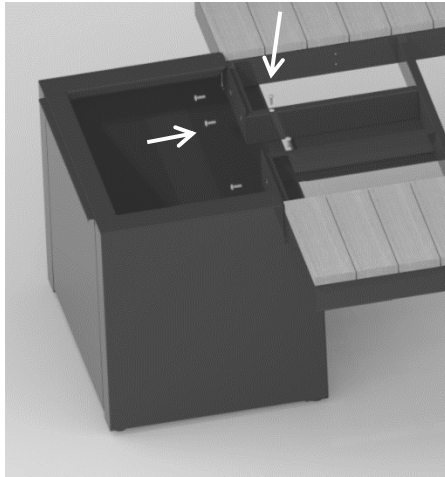

6. Using a Philips screwdriver and supplied bolts (4), attach the support base to the top as shown in the image below. Top may be needed to be lifted to help position support base.

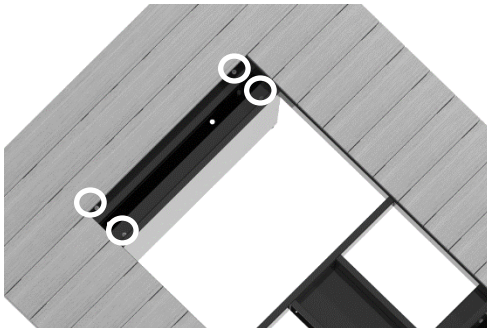

7. Align concrete top to be centered on tank base & overhanging rear to match sides.

**\*DO NOT SLIDE SUPERCAST ON WOOD TOP\***

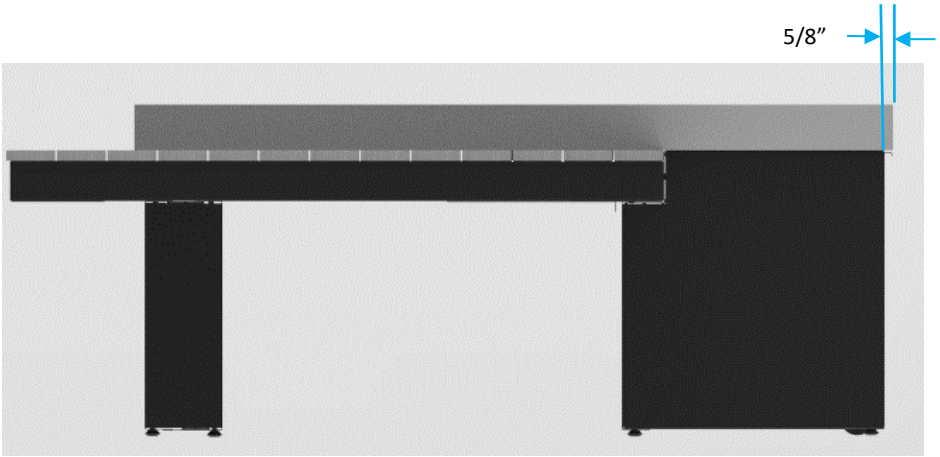

**\*May have to adjust level legs to get Supercast top to sit flat\***

**If the table is relocated, remove Supercast top while moving.  
Failure to do so may result in the wood frame warping.**

**Read and understand your Crystal Fire® Plus owner's manual  
before installing burner or operating the device.**

# SPARKER Installation

- Remove CF-SPARKER cap and hex nut. Insert AAA battery (not included) with + end out.
- Install CF-SPARKER into control panel as shown below.
- Depress CF-SPARKER button to test your sparker.

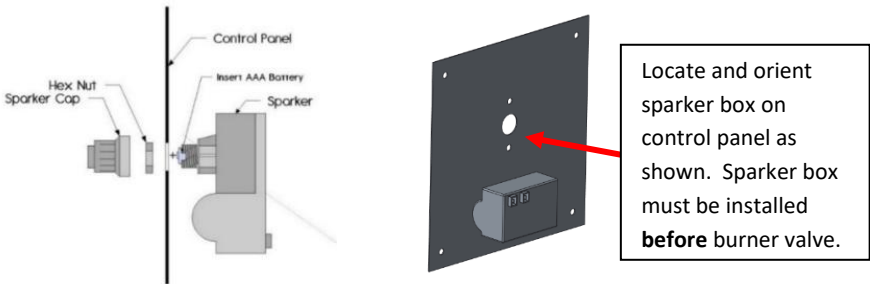

# Gas Connections

**Read and understand your Crystal Fire Burner Owner's manual before beginning burner hookups or using the device.**  
**Do not use Teflon tape or pipe dope on flare fittings.**

See Crystal Fire Plus® instructions for burner installation.

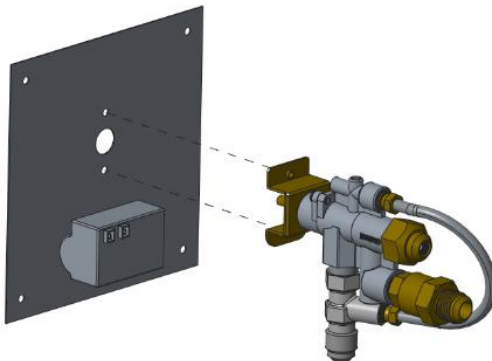

Attach burner valve to control panel with provided screws as shown below. Ensure sparker box is installed before this step.

# Thermocouple Connection

Refer to Crystal Fire® Plus instruction manual for detailed attachment of thermocouple.

- Attach thermocouple to burner valve as shown below.

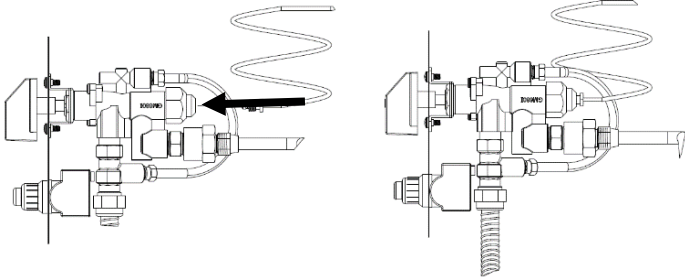

# Electrode Connection

- Connect igniter and ground wire to sparker box. Both wires can connect to either connection point. The unit will operate in either configuration.
- Test system by pushing the button on the ignitor. Consult the troubleshooting section of the Crystal Fire® Plus Burner Owner's Manual, if the spark is weak, intermittent, or not present.

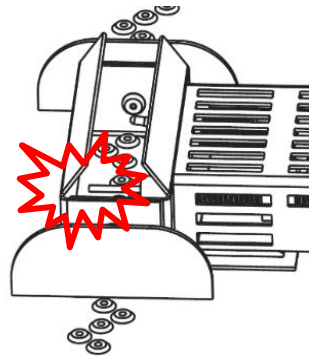
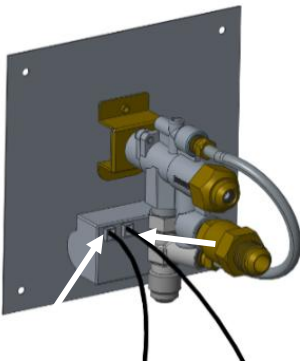

# Install Propane Tank

(If applicable)

- Tilt your propane tank into the slide out tank drawer.

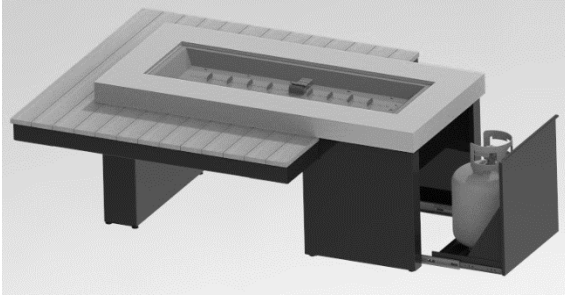

- With the propane tank and control valve in the OFF position, connect the Regulator Hose, included with the Crystal Fire® Plus burner, to your propane tank. Hand tighten connection, do not use tools to tighten this connection.

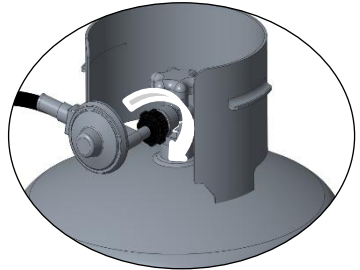

- Slide tank drawer in. Ensure that the Gas hose does not get pinched in the process of sliding the tank drawer.

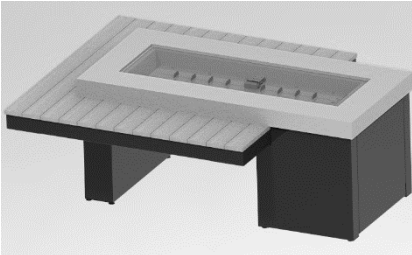

**NOTE:** Over time the bearings in the door glides may require re-greasing. Any spray lubricant, such as WD-40, may be used to lubricate drawer glides. Perform annually or on an as needed basis to maintain smooth operation.



## Locating Natural Gas Line

(If applicable)

17-3/4 x 4

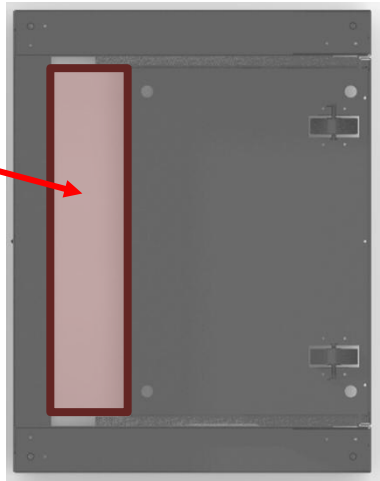

Top View of Base with Door

- Locate natural gas stub inside of the red outline to avoid clearance issues with the door for natural gas installations.

## Care and Maintenance

General cleaning: To remove surface dust, just wash furniture with cold, clear water. Scrub boards with soap and water solution using a soft sponge or plastic-bristled brush.

Cosmetic repairs: Fill any small gouges or scratches with colored silicone sealants and smooth the area for an even finish.

## Fire Media Installation

- Scatter all included glass beads, lava rock, or other approved fire media evenly across entire burner surface keeping it out of the guard on the burner. Consult the Crystal Fire® Plus manual for detailed instructions.

**DO NOT BURN WITHOUT GLASS OR OTHER APPROVED  
DECORATIVE FIRE MEDIA**

**DO NOT BURN WITH GLASS COVER INSTALLED**

### **IMPORTANT**

Please consult your Crystal Fire® Plus instruction manual for detailed instructions and important information related to connecting your linear burner, including safety information, proper tightening of connections and full burner installation and lighting instructions.

**DO NOT ATTEMPT TO INSTALL CFP1242 BURNER WITHOUT FIRST CONSULTING THE MANUAL. IF YOU ARE UNSURE OF HOW TO COMPLETE THE STEPS OUTLINED, CONSULT A QUALIFIED TECHNICIAN**

### **WARNING**

After consulting the manual and following instructions, remember; before operating, all gas connections must be fully checked for leaks.

 **WARNING:** This product can expose you to chemicals including Carbon Monoxide and Benzene which are known to the State of California to cause cancer or birth defects or reproductive harm. For more information, visit [www.P65Warnings.ca.gov](http://www.P65Warnings.ca.gov)

**Warranty:** Fire pit tables are covered under a 3-year manufacturer's warranty. Supercast concrete tops are covered under a 1-year warranty, see website for more warranty information. Please visit <https://www.outdoorrooms.com/product-registration>

Thank you for purchasing an Outdoor GreatRoom Company product! This fire pit was made with pride in the USA.



## Service Parts

- **Refer to Crystal Fire® Plus instruction manual for burner service parts**

| Part   | Part number     |
|--|-----------------|
| Supercast – Antique Mahogany                   | 2554-1242-LIN   |
| Supercast – Coastal Grey                       | 2554-1242-NAT   |
| Supercast – Seashell                           | 25541242GRMM    |
| Top Assembly – Antique Mahogany                | UPTOWN-AMH-TOP  |
| Top Assembly – Coastal Grey                    | UPTOWN-CGR-TOP  |
| Top Assembly – Seashell                        | UPTOWN-SHL-TOP  |
| Tank Base Assembly<br>(Includes door assembly) | UPT-BN-TNK-IRO  |
| Small Pedestal Assembly                        | UPTOWN-BASE-IRO |
| Glass Burner Cover                             | 1242GGC         |



9583 217<sup>th</sup> St. W. • Lakeville, MN 55044  
Toll Free: 1-866-303-4028 • [Sales@OutdoorRooms.com](mailto:Sales@OutdoorRooms.com)