



NEW! BI-50-DEEP-XT Electric Fireplace shown with Fire & Ice®



72-TRU-VIEW-XL Electric Fireplace shown with Fire & Ice®



BI-50-XTRASLIM Electric Fireplace shown with Fire & Ice®

PANORAMA SERIES

ELECTRIC FIREPLACES
INDOOR • OUTDOOR

Amantii

PANORAMA EXTRA SLIM



BI-60-XTRASLIM Electric Fireplace with Fire & Ice®



Our Panorama series family just got better with the addition of the Extra Slim! With an opening height of 11-7/8" and available in four sizes, you'll find a unit that is perfect for any space in your home, business or commercial space. At just 4" in depth, the XS is perfectly suited to installations where wall depth is at a premium.

Boasting our FIRE & ICE® Flame presentation with three color LED light strips allowing for multi-color flame options. With just a click of the included remote control, choose from blue, rose, violet, yellow or orange colored flames. The Extra Slim model comes standard with clear decorative media with additional media options available for purchase.

KEY FEATURES: Extra Slim

- Heater & Fan
- Hard-wire ready
Thermostat hard-wire ready
- Rated for indoor & outdoor use including bathrooms
- Very thin - only 4" in depth
- Perfect for zone heating.
Approx. 500 sq. ft. 4800 BTUs
- FIRE & ICE® Flame presentation.
Three light strips allow for yellow, orange, blue, violet & rose colored flames

LIGHTING



Fire & Ice Flame®: Vibrant multi-colored state-of-the-art FIRE & ICE® flame that is easily changed from purple to orange or yellow to blue to purple, rose or violet to blue with just a click of the remote.

FEATURES & ACCESSORIES

EXTRA SLIM

The heater and fan is located in the top of the unit and the glass is uniquely angled backwards to allow heat to cascade down over the front of the fireplace

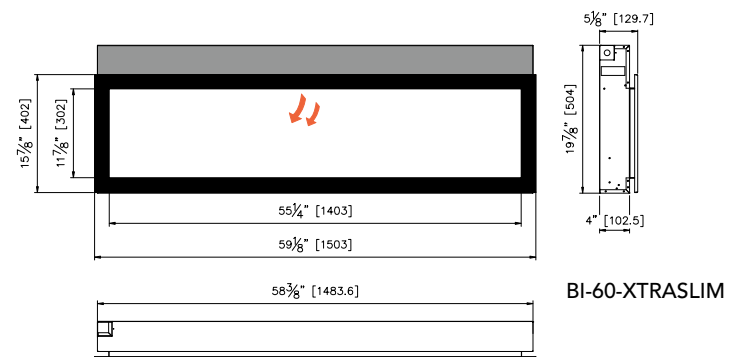
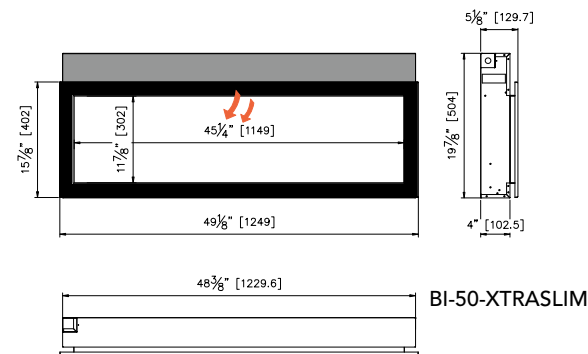
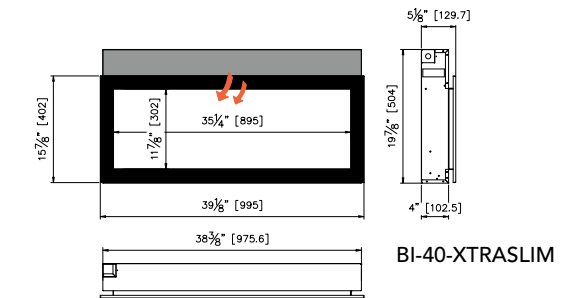
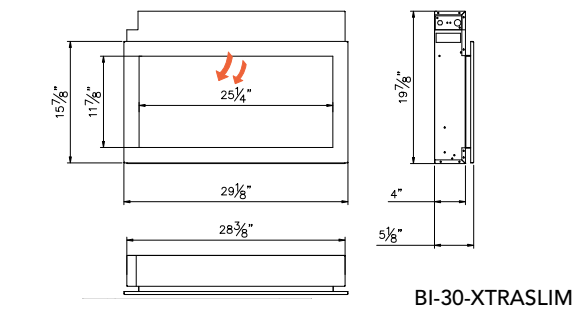
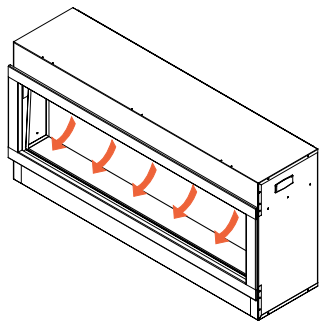

It's all in the Box!

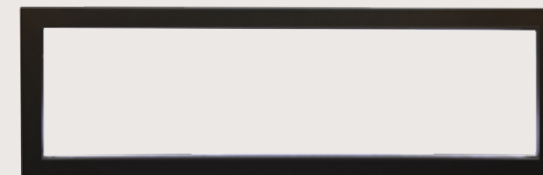

Panorama Series Stainless Steel Covers are available for an additional charge. Cover is required for all outdoor installations.

	BI-30	BI-40	BI-50	BI-60
Volts	120	120	120	120
Amps	12.5	12.5	12.5	12.5
Watts	1500 max	1500 max	1500 max	1500 max
Heater On	1500 watts high, 750 watts low	1500 watts high, 750 watts low	1500 watts high, 750 watts low	1500 watts high, 750 watts low
Heater Off	22 watts	22 watts	22 watts	22 watts
Lamps	LED 22 watts	LED 22 watts	LED 22 watts	LED 22 watts
Rotor Motor	1 at 5 watts	1 at 5 watts	1 at 5 watts	1 at 5 watts
Height, Width, Depth	19-7/8 x 29-1/8 x 4	19-7/8 x 39-1/8 x 4	19-7/8 x 49-1/8 x 4	19-7/8 x 59-1/8 x 4
Glass Viewing Opening	11-7/8 x 25-1/4	11-7/8 x 35-1/4	11-7/8 x 45-1/4	11-7/8 x 55-1/4
Surround Size	15-7/8 x 29-1/8	15-7/8 x 39-1/8	15-7/8 x 49-1/8	15-7/8 x 59-1/8
Shipping Size	35-3/4 x 7-1/2 x 23	45-3/4 x 7-1/2 x 23	55-3/4 x 7-1/2 x 23	65-3/4 x 7-1/2 x 23
Shipping Weight	89 lbs. Glass Included	88 lbs. Glass Included	105.6 lbs. Glass Included	123.2 lbs. Glass Included

PANORAMA SLIM



BI-40-SLIM Electric Fireplace shown with Fire & Ice® media

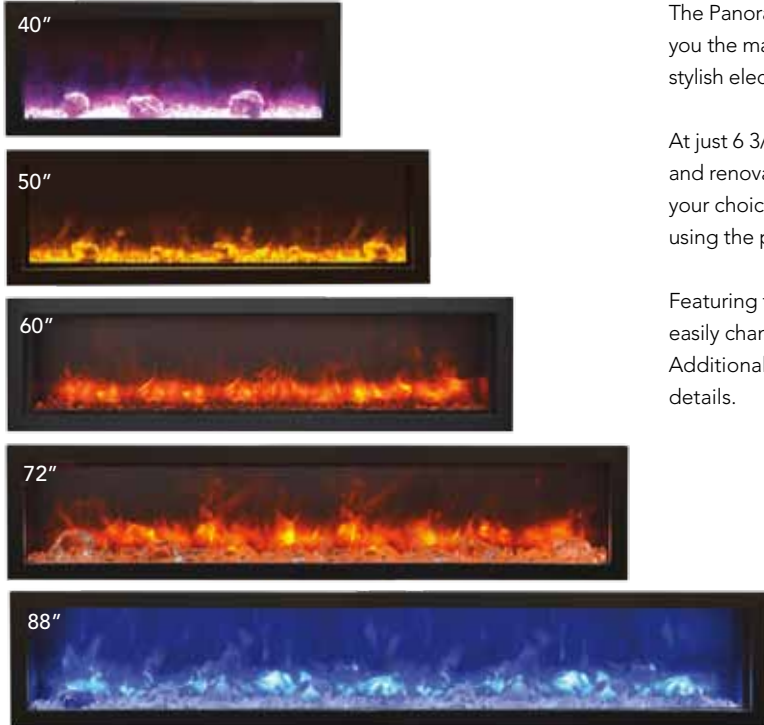

LIGHTING



Fire & Ice Flame®: Vibrant multi-colored state-of-the-art FIRE & ICE® flame that is easily changed from purple to orange or yellow to blue to purple, rose or violet to blue with just a click of the remote.

The Panorama Deep Series of built-in electric fireplaces have been designed to give you the maximum in flexibility in selecting a unit that perfectly suits your needs. The stylish electric fireplace will be a focal point in any room, indoor or outdoor.

At just 6 3/4" in depth, the Slim is a practical choice for new construction projects and renovations alike. As well as giving you the ability to install your fireplace with your choice of finishing material built right to the glass for a "clean face" design or using the provided black metal surround. Your choice – your design!

Featuring the vibrant FIRE & ICE® flame set, with just a click of your remote you can easily change the flame colour from blue to purple to violet to orange or yellow. Additional media options available for purchase, please see back page for more details.

KEY FEATURES: Slim

- FIRE & ICE® Flame presentation. Three light strips allow for yellow, orange, blue, violet & rose colored flames
- Heater & Fan Flame operates with or without heat
- Perfect for zone heating. Approx. 500 sq. ft. 4800 BTUs
- Hard-wire ready Thermostat hard-wire ready
- Slim 6-3/4" comes with large glass chunks, clear & blue diamond fire glass media, black steel surround that can be installed if preferred

FEATURES & ACCESSORIES SLIM

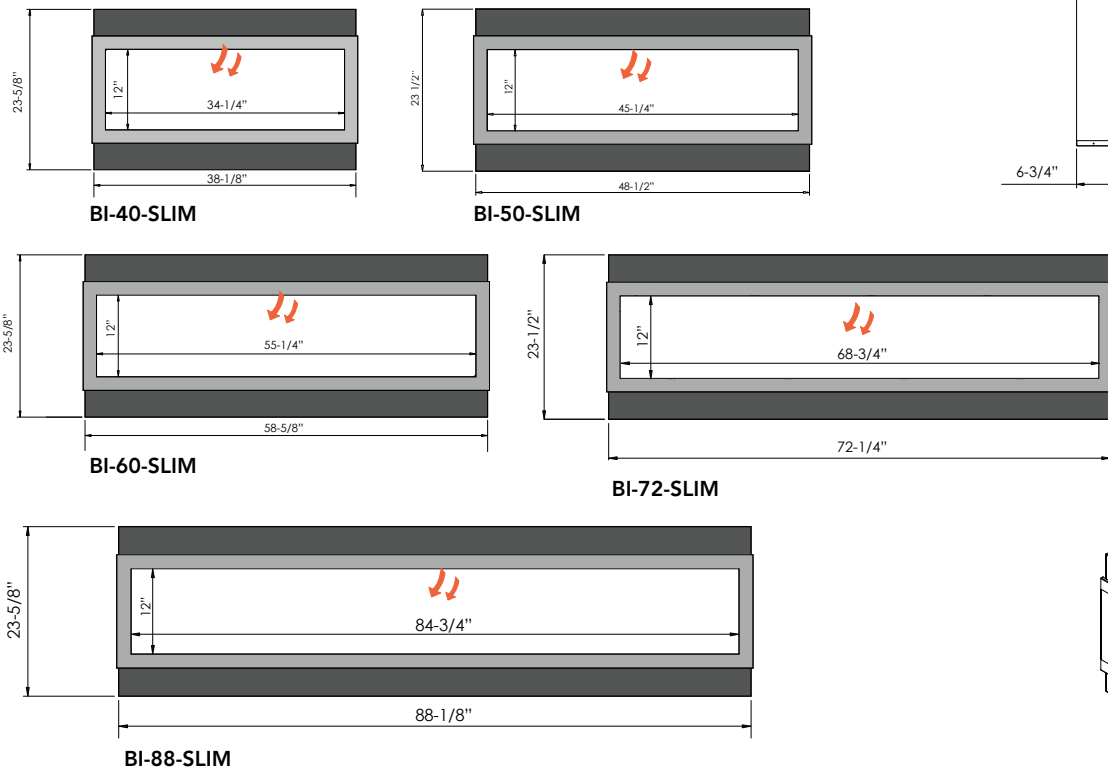

6-3/4" Slim Models - Single flame set

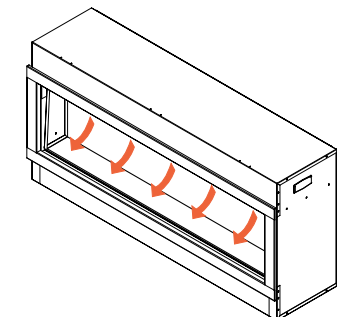
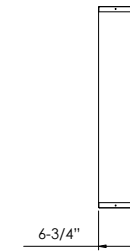

The heater and fan is located in the top of the unit and the glass is uniquely angled backwards to allow heat to cascade down over the front of the fireplace



Panorama Series Stainless Steel Covers are available for an additional charge. Cover is required for all outdoor installations.

It's all in the Box!

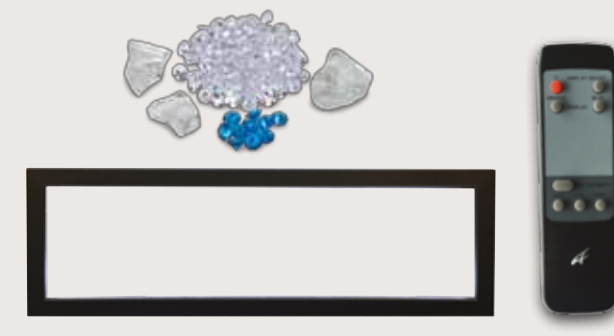

	BI-40	BI-50	BI-60	BI-72	BI-88
Volts	120	120	120	120	120
Amps	12.5	12.5	12.5	12.5	12.5
Watts	1500 max	1500 max	1500 max	1500 max	1500 max
Heater On	1500 watts high, 750 watts low	1500 watts high, 750 watts low	1500 watts high, 750 watts low	1500 watts high, 750 watts low	1500 watts high, 750 watts low
Heater Off	22 watts	22 watts	22 watts	22 watts	22 watts
Lamps	LED 22 watts	LED 22 watts	LED 22 watts	LED 22 watts	LED 22 watts
Rotor Motor	1 at 5 watts	1 at 5 watts	1 at 5 watts	1 at 5 watts	1 at 5 watts
Height, Width, Depth	23 5/8 x 38 1/8 x 6-3/4	23-1/2 x 48-1/2 x 6-3/4	23-1/2 x 58-5/8 x 6-3/4	23 1/2 x 72 1/4 x 6-3/4	23 1/2 x 88 1/8 x 6-3/4
Glass Viewing Opening	12 x 34-1/4	12 x 45-1/4	12 x 55-1/4	12 x 68-3/4	12 x 84-3/4
Surround Size	15-3/4 x 38-5/8	15-3/4 x 49-1/4	15-3/4 x 59-1/8	15-3/4 x 72-3/4	15-3/4 x 88-1/8
Shipping Size	25-1/4 x 49-3/4 x 10-1/4	25-3/4 x 58 x 10-1/4	25-1/2 x 58 x 10-1/4	25-1/4 x 81-1/8 x 10-1/4	25-1/4 x 97-1/4 x 10-1/4
Shipping Weight	89 lbs. Glass Included	106 lbs. Glass Included	124 lbs. Glass Included	150 lbs. Glass Included	188 lbs. Glass Included

PANORAMA DEEP



BI-50-DEEP Electric Fireplace shown with optional Sable fireglass and log set



The Panorama Deep Series of built-in electric fireplaces have been designed to give you the maximum in flexibility in selecting a unit that perfectly suits your needs.

The stylish electric fireplace will be a focal point in any room, indoor or outdoor.

The Deep Series gives you a 12" depth and multiple length options, as well as giving you the ability to install your fireplace with your choice of finishing material built right to the glass for a "clean face" design or using the provided black metal surround. Your choice – your design!

Featuring the vibrant Fire & Ice® flame set, with just a click of your remote you can easily change the flame colour from blue to purple to violet to orange or yellow. Additional media options available for purchase, please see back page for more details.

KEY FEATURES: Deep

-  FIRE & ICE® Flame presentation. Three light strips allow for yellow, orange, blue, violet & rose colored flames
-  Heater & Fan Flame operates with or without heat
-  Perfect for zone heating. Approx. 500 sq. ft. 4800 BTUs
-  Hard-wire ready Thermostat hard-wire ready
-  Illuminate decorative media like never before with ambient canopy lighting in 13 colors
-  Deep 12" comes with large glass chunks, clear & blue diamond fire glass media, an 11 piece log set, and black steel surround that can be installed if preferred

FEATURES & ACCESSORIES DEEP

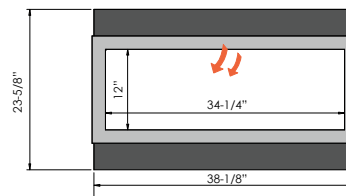

BI-40-DEEP

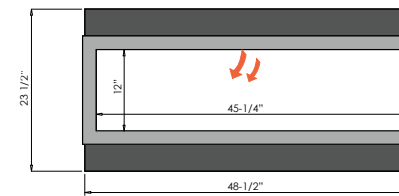

BI-50-DEEP

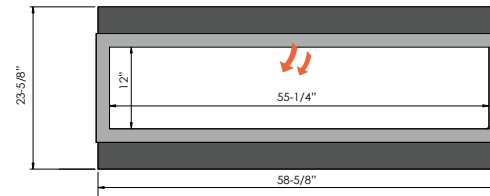

BI-60-DEEP

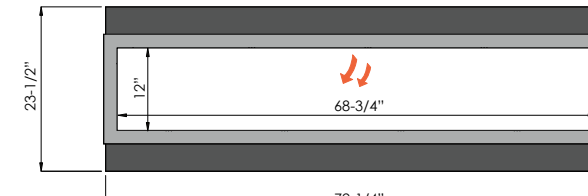

BI-72-DEEP

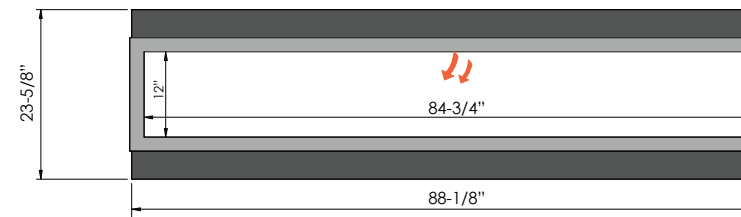

BI-88-DEEP

12" Deep Models - 2 flame sets

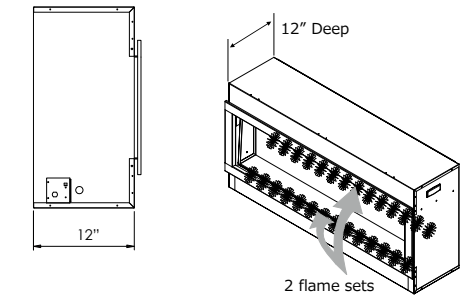

The heater and fan is located in the top of the unit and the glass is uniquely angled backwards to allow heat to cascade down over the front of the fireplace

LIGHTING



Ambient canopy lighting: Shown On and Off, illuminate media like never before with a spectrum of lighting in 13 different colors.



Fire & Ice Flame®: Vibrant multi-colored state-of-the-art FIRE & ICE® flame that is easily changed from purple to orange or yellow to blue to purple, rose or violet to blue with just a click of the remote.



Panorama Series Stainless Steel Covers are available for an additional charge. Cover is required for all outdoor installations.

It's all in the Box!



	BI-40	BI-50	BI-60	BI-72	BI-88
Volts	120	120	120	120	120
Amps	12.5	12.5	12.5	12.5	12.5
Watts	1500 max	1500 max	1500 max	1500 max	1500 max
Heater On	1500 watts high, 750 watts low	1500 watts high, 750 watts low	1500 watts high, 750 watts low	1500 watts high, 750 watts low	1500 watts high, 750 watts low
Heater Off	22 watts	22 watts	22 watts	22 watts	22 watts
Lamps	LED 22 watts	LED 22 watts	LED 22 watts	LED 22 watts	LED 22 watts
Rotor Motor	1 at 5 watts	1 at 5 watts	1 at 5 watts	1 at 5 watts	1 at 5 watts
Height, Width, Depth	23 5/8 x 38 1/8 x 12	23-1/2 x 48-1/2 x 12	23-1/2 x 58-5/8 x 12	23 1/2 x 72 1/4 x 12	23 1/2 x 88 1/8 x 12
Glass Viewing Opening	12 x 34-1/4	12 x 45-1/4	12 x 55-1/4	12 x 68-3/4	12 x 84-3/4
Surround Size	15-3/4 x 38-5/8	15-3/4 x 49-1/4	15-3/4 x 59-1/8	15-3/4 x 72-3/4	15-3/4 x 88-1/8
Shipping Size	25-1/4 x 47-3/4 x 14-1/2	25-3/4 x 58 x 14-1/2	25-1/2 x 58 x 14-1/2	25-1/4 x 81-1/8 x 14-1/2	25-1/4 x 97-1/4 x 14-1/2
Shipping Weight	93 lbs. Glass Included	111 lbs. Glass Included	128 lbs. Glass Included	157 lbs. Glass Included	197 lbs. Glass Included

PANORAMA EXTRA TALL



BI-60-DEEP-XT Electric Fireplace shown with log set



Featuring an Extra Tall viewing area that is 18" in height! That is 6" taller than our other Panorama models. It has a deep media tray and comes standard with an incredible 11 piece log set, ICE media, pebbles, stones, black glass and vermiculite embers allowing consumers to completely customize the look of their fireplace.

Built with Amantii's FIRE & ICE® Flame presentation made of three color LED light strips allowing for multi-color flame options. With just a click of the included remote control, choose from blue, rose, violet, yellow or orange colored flames. Additional media options available for purchase, please see back page for more details.

KEY FEATURES: Extra Tall

- Heater & Fan
- Rated for indoor & outdoor use including bathrooms
- Perfect for zone heating. Approx. 500 sq. ft. 4800 BTUs
- Hard-wire ready
Thermostat hard-wire ready
- Glass viewing area is 18" in height
- FIRE & ICE® Flame presentation. Three light strips allow for yellow, orange, blue, violet & rose colored flames

FEATURES & ACCESSORIES EXTRA TALL

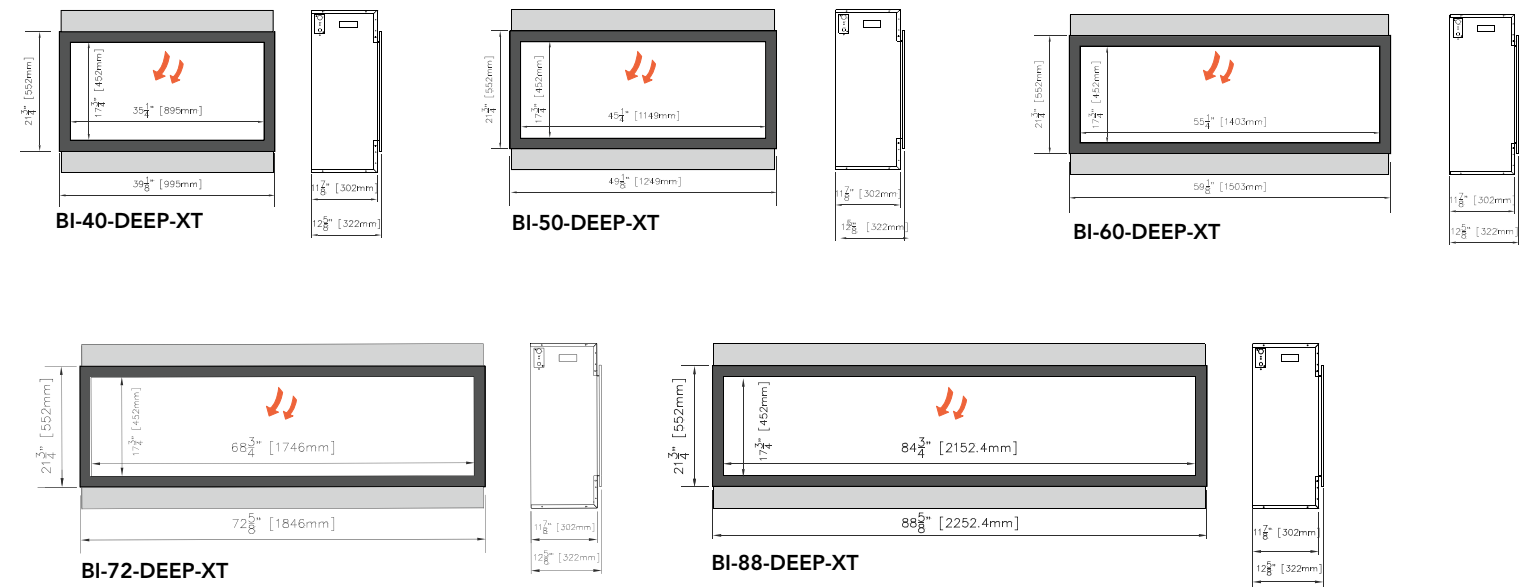

LIGHTING



Ambient canopy lighting: Shown On and Off, illuminate media like never before with a spectrum of lighting in 13 different colors.



Fire & Ice Flame®: Vibrant multi-colored state-of-the-art FIRE & ICE® flame that is easily changed from purple to orange or yellow to blue to purple, rose or violet to blue with just a click of the remote.

	BI-40	BI-50	BI-60	BI-72	BI-88
Volts	120	120	120	120	120
Amps	12.5	12.5	12.5	12.5	12.5
Watts	1500 max	1500 max	1500 max	1500 max	1500 max
Heater On	1500 watts high, 750 watts low	1500 watts high, 750 watts low	1500 watts high, 750 watts low	1500 watts high, 750 watts low	1500 watts high, 750 watts low
Heater Off	22 watts	22 watts	22 watts	22 watts	22 watts
Lamps	LED 22 watts	LED 22 watts	LED 22 watts	LED 22 watts	LED 22 watts
Rotor Motor	1 at 5 watts	1 at 5 watts	1 at 5 watts	1 at 5 watts	1 at 5 watts
Height, Width, Depth	29-1/2 x 38-5/8 x 12-5/8	29-1/2 x 48-5/8 x 12-5/8	29-1/2 x 58-5/8 x 12-5/8	29-1/2 x 72-1/8 x 12-5/8	29-1/2 x 88-5/8 x 12-5/8
Glass Viewing Opening	11-7/8 x 35-1/4	11-7/8 x 45-1/4	11-7/8 x 55-1/4	17-3/4 x 68-3/4	17-3/4 x 84-3/4
Surround Size	21-3/4 x 39-1/8	21-3/4 x 49-1/8	21-3/4 x 59-1/8	21-3/4 x 72-5/8	21-3/4 x 88-5/8
Shipping Size	45-1/4 x 14-1/2 x 31-1/4	55-1/2 x 14-1/2 x 31-1/4	65-1/2 x 14-1/2 x 31-1/4	82-1/2 x 14-1/2 x 31-1/4	98-1/2 x 14-1/2 x 31-1/4
Shipping Weight	94.6 lbs. Glass Included	110 lbs. Glass Included	127.6 lbs. Glass Included	156.2 lbs. Glass Included	195.8 lbs. Glass Included

TRU-VIEW XL



60-TRU-VIEW-XL Electric Fireplace shown with log set









The TRU-VIEW-XL 3 sided electric fireplace is truly innovative! The gorgeous flame presentation and unique media options can now be viewed from almost any angle through 3 sides of glass viewing area.

Designed for finishing materials are to built flush to the lip for a clean face finish. Built-In only. No trim or surround included.

Perfect for any space, inside or out, including bathrooms.

Boasting a depth of 14 1/4", the TRU-VIEW-XL features two flame sets, ambient canopy lighting in 13 colors to illuminate the decorative media like never before and our exclusive FIRE & ICE® flame presentation that allows users to choose from blue, rose, violet, yellow or orange colored flames with just the click of the remote control. Additional media options available for purchase, please see back page for more details.

KEY FEATURES: Tru-View XL

-  FIRE & ICE® Flame Presentation. Three light strips allow for yellow, orange, blue, violet & rose colored flames
-  Illuminate decorative media like never before with ambient canopy lighting in 13 colors
-  Heater & Fan Flame operates with or without heat
-  Thermostat hard-wire ready Electrical hard-wire ready
-  Perfect for zone heating approx. 400-500 sq ft. 4800 BTU
-  14-1/4" deep comes with large glass chunks, clear & blue diamond fire glass media, and our new Designer media kit that includes a deluxe 11 piece log set, black stones, rocks, pebbles, two kinds of vermiculite chips and two kinds of vermiculite embers

FEATURES & ACCESSORIES

TRU-VIEW XL

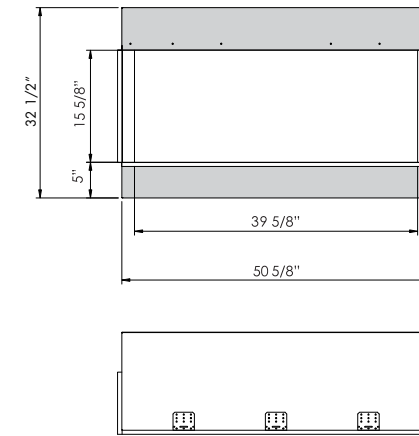

40-TRU-VIEW-XL

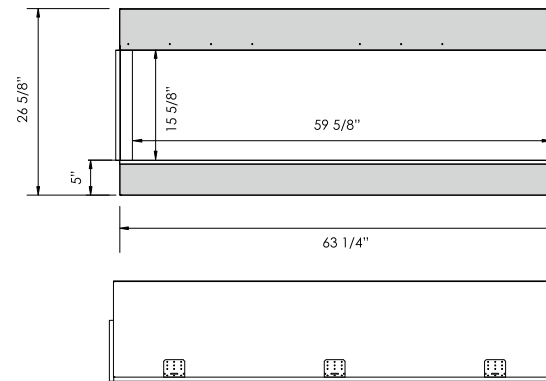

60-TRU-VIEW-XL

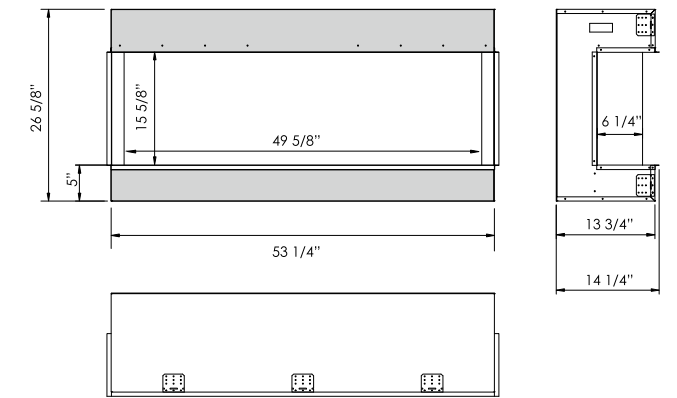

50-TRU-VIEW-XL

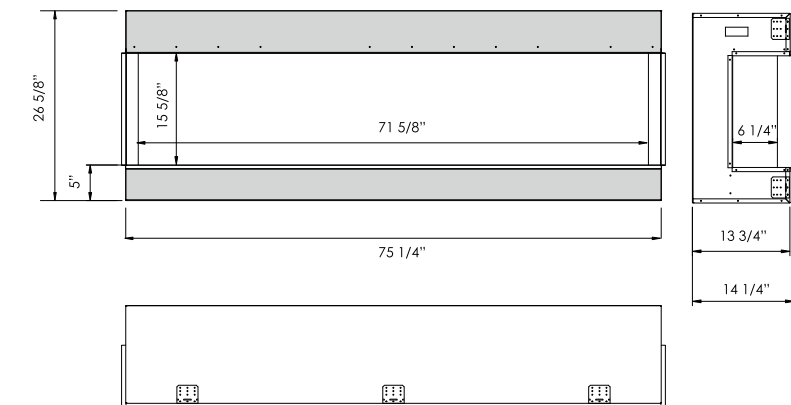

72-TRU-VIEW-XL

LIGHTING



Ambient canopy lighting: Shown On and Off, illuminate media like never before with a spectrum of lighting in 13 different colors.



Fire & Ice Flame®: Vibrant multi-colored state-of-the-art FIRE & ICE® flame that is easily changed from purple to orange or yellow to blue to purple, rose or violet to blue with just a click of the remote.

Volts	120
Amps	12.5
Watts	1500 max
Heater On	1500 watts high, 750 watts low
Heater Off	22 watts
Lamps	LED 22 watts
Rotor Motor	1 at 5 watts
Plug Location	Left Side
Cord Length	70 7/8"
Approx. Heat Area	400 sq. ft.



FIRE GLASS & MEDIA OPTIONS

Amantii / Sierra Flame decorative fire glass media is a beautiful addition to your electric fireplace. Turn your fireplace into a expressive work of art by simply adding our decorative fire glass media. Our fire glass adds a distinctly modern feel to your electric fireplace - mix colors and textures for a unique appearance.

Always wear protective gloves when handling fire glass media. One 5lb container of media will cover 1 square foot.

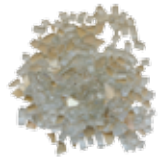

AMSF-GLASS-01

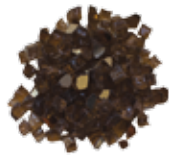

AMSF-GLASS-02



AMSF-GLASS-03

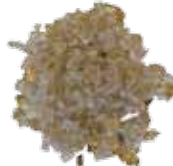

AMSF-GLASS-04



AMSF-GLASS-05



AMSF-GLASS-06



AMSF-GLASS-07



AMSF-GLASS-08



AMSF-GLASS-09



AMSF-GLASS-10

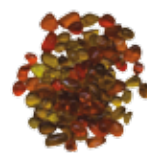

AMSF-GLASS-11



AMSF-GLASS-12



AMSF-GLASS-13

DESIGNER MEDIA KITS

DESIGN-MEDIA-6PCE



DESIGN-MEDIA-11PCE



DESIGN-MEDIA-14PCE



DECORATIVE MEDIA OPTIONS



Note: Log sets and Designer Media Kits will fit in all sizes of the following models - Panorama DEEP, DEEP-XT and TRU-VIEW-XL ONLY

(For the Design Media 11 piece & Design Media 14 piece, depending on the size of the fireplace model, some logs may not be needed.)



February 2018

Distributed By:

Images are not to scale, please visit your local dealer to view the actual accessories. Variations in the color and shade are inherent in all printing processes, the actual colors may vary slightly from those shown in this brochure. Please visit your local dealer to view a sample.

Amantii

Phone: 877.850.9458

Web site: www.amantii.com

We reserve the right to update products, specifications and dimensions are subject to change. Please refer to the product manual to verify measurements and clearance requirements. All local building codes must be followed.