

Modore 240 Tenore 240

Product Information



Tenore 240 Promotional Video



Gas Fireplaces

DANGER

**HOT GLASS WILL CAUSE BURNS.
DO NOT TOUCH GLASS UNTIL COOLED.
NEVER ALLOW CHILDREN TO TOUCH GLASS.**



Une surface vitrée chaude peut causer des brûlures. Laisser refroidir la surface vitrée avant d'y toucher. Ne permettez jamais à un enfant de toucher la surface vitrée.

A barrier designed to reduce the risk of burns from the hot viewing glass is provided with this appliance and shall be installed for the protection of children and other at-risk individuals.

Une barrière conçu pour réduire le risque de brûlure par le verre de visualisation chaude est fournie avec cet appareil et doit être installé pour la protection des enfants et autres personnes à risque.

 **WARNING:**
FIRE OR EXPLOSION HAZARD
Failure to follow safety warnings exactly could result in serious injury, death, or property damage.

- Do not store or use gasoline or other flammable vapors and liquids in the vicinity of this or any other appliance.
- **WHAT TO DO IF YOU SMELL GAS**
 - Do not try to light any appliance.
 - Do not touch any electrical switch; do not use any phone in your building.
 - Leave the building immediately.
 - Immediately call your gas supplier from a neighbor's phone. Follow the gas supplier's instructions.
 - If you cannot reach your gas supplier, call the fire department.
- Installation and service must be performed by a qualified installer, service agency or the gas supplier.

 **AVERTISSEMENT:**
INCENDIE OU D'EXPLOSION
Le non-respect des avertissements de sécurité à la lettre pourrait entraîner de graves blessures, la mort ou des dommages matériels.

- Ne pas entreposer ni utiliser d'essence ni d'autres vapeurs ou liquides inflammables dans le voisinage de cet appareil ou de tout autre appareil.
- **QUE FAIRE SI VOUS SENTEZ UNE ODEUR DE GAZ**
 - Ne pas tenter d'allumer d'appareil.
 - Ne touchez à aucun interrupteur. Ne pas vous servir des téléphones se trouvant dans le bâtiment ou vous trouvez.
 - Quitter immédiatement le bâtiment.
 - Appelez immédiatement votre fournisseur de gaz depuis un voisin. Suivez les instructions du fournisseur.
 - Si vous ne pouvez rejoindre le fournisseur de gaz appelez le service des incendies.
- Installation et l'entretien doivent être effectués par un installateur qualifié, une agence de service ou le fournisseur de gaz.

INSTALLER: Leave this manual with the appliance.
CONSUMER: Retain this manual for future reference.

INSTALLATEUR: Laissez cette notice avec l'appareil.
CONSOMMATEUR: Conservez cette notice pour consultation ultérieure.

TABLE OF CONTENTS

Important Safety Information	3
User Information	6
Specifications and Dimensions	7
<i>Modore 240</i>	9
<i>Tenore 240</i>	10
<i>Parts of the Fireplace</i>	11
Clearances	13
Gas and Electric	18
Venting	19
<i>Horizontal</i>	21
<i>Vertical</i>	24
Enclosing the Fireplace	28
<i>Non- combustible Materials List</i>	28
<i>Convection Air Opening</i>	29
<i>Rough Opening Dimensions</i>	32
Operating the Fireplace	36
Installing the Fire Media	40
<i>Logs</i>	41
<i>Stones</i>	43
Screen Installation	44
Maintenance	49
<i>Glass</i>	49
<i>Burner</i>	52
<i>Pilot</i>	52
<i>Thermocouple</i>	53
<i>Venting</i>	53
Replacement Parts	53
Warranty	54
Massachusetts Certification	Appendix One
Troubleshooting Flowchart	Appendix Two
LP Conversion	Appendix Three
Installing the Optional Wall Switch	Appendix Four
Index	---

IMPORTANT SAFETY INFORMATION

CAUTION - HOT! HOT! HOT!

This appliance is a HEATING appliance and it does become very hot in operation. UNDER ANY CIRCUMSTANCES, DO NOT PLACE any object, furniture, draperies or other item LESS THAN 36"/90 cm IN FRONT OF THE GLASS OF THE FIREPLACE.

CHILDREN AND PETS

Radiant heat can heat surfaces such as the surround and trims of the fireplace to temperatures that, although approved safe, can be quite uncomfortable to touch - particularly for children and pets. Children and pets should always be supervised when in the room where the appliance is located. Remote control handset should be kept out of reach of children. In the presence of children, we STRONGLY RECOMMEND that you install in front of the fireplace: a fire screen or, to protect young toddlers, a "hearth gate".

HOT SURFACES

Be aware that, although safe, some combustible materials and finishes, even though installed at listed clearances may, over time, discolor, warp or show cracks.

Convective heat will exit the unit and travel up the wall surface if not impeded. Protruding mantels and projections can help direct the heat away from the wall. AVOID placing heat sensitive items such as televisions, paintings, decorations, etc. above fireplaces or near the edge of protrusions unless appropriate.

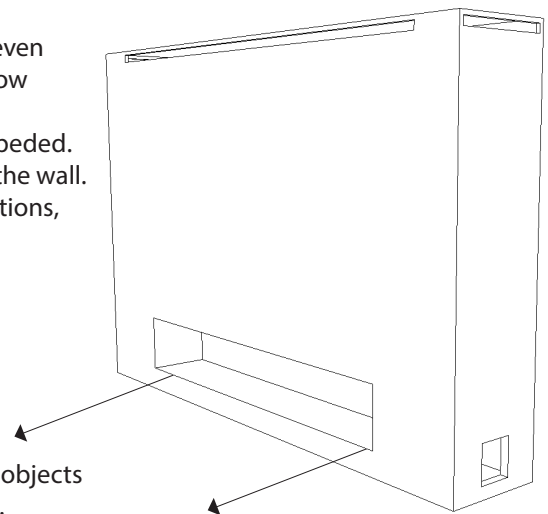

Do not place furniture or other objects within 36" of the fireplace glass.

SAVE THESE INSTRUCTIONS

Make yourself fully aware of all the following instructions and the many features of the Element4 direct vent gas fireplace appliance.

INSTALLER: Leave this manual with the appliance.

OWNER: Keep this manual for future reference.

IMPORTANT SAFETY INFORMATION

WARNING

Children and adults should be alerted to the hazards of high surface temperature and should stay away to avoid burns or clothing ignition.

WARNING

This direct vent system appliance must be installed as an OEM installation in manufactured homes (USA only) or an aftermarket permanently located, or a mobile home, **where not prohibited by local codes** and must be installed in accordance with Manufacturer's instructions and the Manufactured Home Construction and Safety Standard, Title 24 CFR, Part 3280, in the United States, or the Standard for Installation in Mobile Homes, CAN/CSA Z240 MH Series, in Canada.

If the information in these instructions is not followed exactly a fire or explosion may result causing property damage, personal injury or death.

Do not store or use gasoline or other flammable vapors and liquids in the vicinity of this appliance.

WARNING: Glass Handling

The glass must only be removed by a qualified person. Gloves should be worn when removing the glass.

WARNING: Installation and Service

Installation and service must be performed by an authorized qualified installer, service agency or gas supplier.

Any alteration to the product that causes soot or carbon to form and results in damage is not the responsibility of the manufacturer.

ONLY a qualified person may open the door/remove the glass.

Do not modify or substitute any part of this appliance.

WARNING: Electrical Grounding

These direct vent appliances must be electrically grounded in accordance with the local codes or, in the absence of local codes, with National Electric code, ANSI/NFPA 70, or the Canadian Electric Code, CSA C22.1

WARNING: Gas Appliance

This appliance is only for use with the type of gas indicated on the rating plate. These appliances are not convertible for use with other gases unless a certified kit is used and the conversion is performed by an authorized qualified technician.

Applicable standards are ANSI Z21.50/CSA 2.22 (Vented Gas Fireplaces) and CAN/CGA 2.17-M91 (Gas-fired Appliances for Use at High Altitudes.) If your installation is at an elevation greater than 2000' in the US or 4500' in Canada, consult with the local authority having jurisdiction for gas product installations to determine their specific requirements for high altitude installations.

IMPORTANT SAFETY INFORMATION

This gas fireplace and vent assembly **MUST** be vented directly to the outside and **MUST NEVER** be attached to a chimney serving a separate solid fuel burning appliance. Each gas appliance **MUST BE** a separate vent system. Common vent systems are prohibited.

TURN OFF the gas before servicing the appliance. It is recommended that a qualified service technician perform an appliance check-up/service once a year.

Any safety screen or guard removed for servicing **MUST BE REPLACED** before operating this appliance.

This unit **MUST** be used with a vent system as described in this installation manual. **NO OTHER VENT SYSTEM OR COMPONENTS MAY BE USED.**

THIS UNIT IS NOT FOR USE WITH SOLID FUEL, and must only be used with gas supply conditions as indicated on the rating label.

INSPECT the external vent cap on a regular basis to make sure that no debris, plants, trees, or shrubs are interfering with the air flow.

DO NOT USE this appliance if any part has been under water. Immediately call a qualified service technician to inspect the unit and to replace any part of the control system and any gas control that has been under water.

NEVER OBSTRUCT the flow of ventilation air. Keep the front of the appliance **CLEAR** of all obstacles and materials for servicing and proper operation.

DO NOT use this appliance as a temporary source of heat during construction.

This appliance is a vented gas fireplace. It must not be used for any other purposes such as drying clothes, etc.

The glass panels **MUST** be in place and sealed before the unit can be placed into safe operation.

DO NOT OPERATE this appliance with the glass panels removed, cracked or broken. Replacement of the glass panels should be performed by a licensed or qualified service person. **DO NOT** strike or slam the glass panels.

The glass panels **SHALL ONLY** be replaced by units supplied by the manufacturer. **NO SUBSTITUTE** panels shall be used.

DO NOT USE abrasive cleaners on the panels. **DO NOT ATTEMPT** to clean the glass panels when they are hot.

If the pilot flame is extinguished either intentionally or unintentionally, no attempt should be made to re-light the gas until at least 3 minutes have elapsed.

Dimensions will appear as **INCHES**/^{metric} throughout this manual. For convenience, the inches are rounded to the nearest 1/16" when converted. If greater accuracy is required, use the metric dimensions.

USER INFORMATION

WARMTH AND BEAUTY - HOW IT WORKS

The Element4 fireplaces are direct vent fireplaces and, as such, the intake and exhaust are both handled through the vent pipe. The fireplace also provides convection air to your room. The illustration shows one of the unique features of the Element4 fireplaces - its use of warm, convection air flow.

Other fireplaces have louvered metal boxes around them to keep temperatures under control. The Element4 fireplaces use your enclosing walls, or chase, to guide this warm air. This design, therefore, requires the use of non-combustible wall materials and gives you beauty for your effort.

When the air within the chase is warmed by the fireplace, it rises and exits through the Convection Air Outlet. This air is then replaced by room air which enters the chase just above the fireplace glass and through the Wall Access Door. As the exiting warm air cools, it falls to the floor where it's drawn into the inlets and the cycle repeats.

The fireplace provides the *inlet* for room air as part of its design; you provide the warm air *outlet* as part of your design.

See the **ENCLOSING the FIREPLACE** section of this manual for more information.

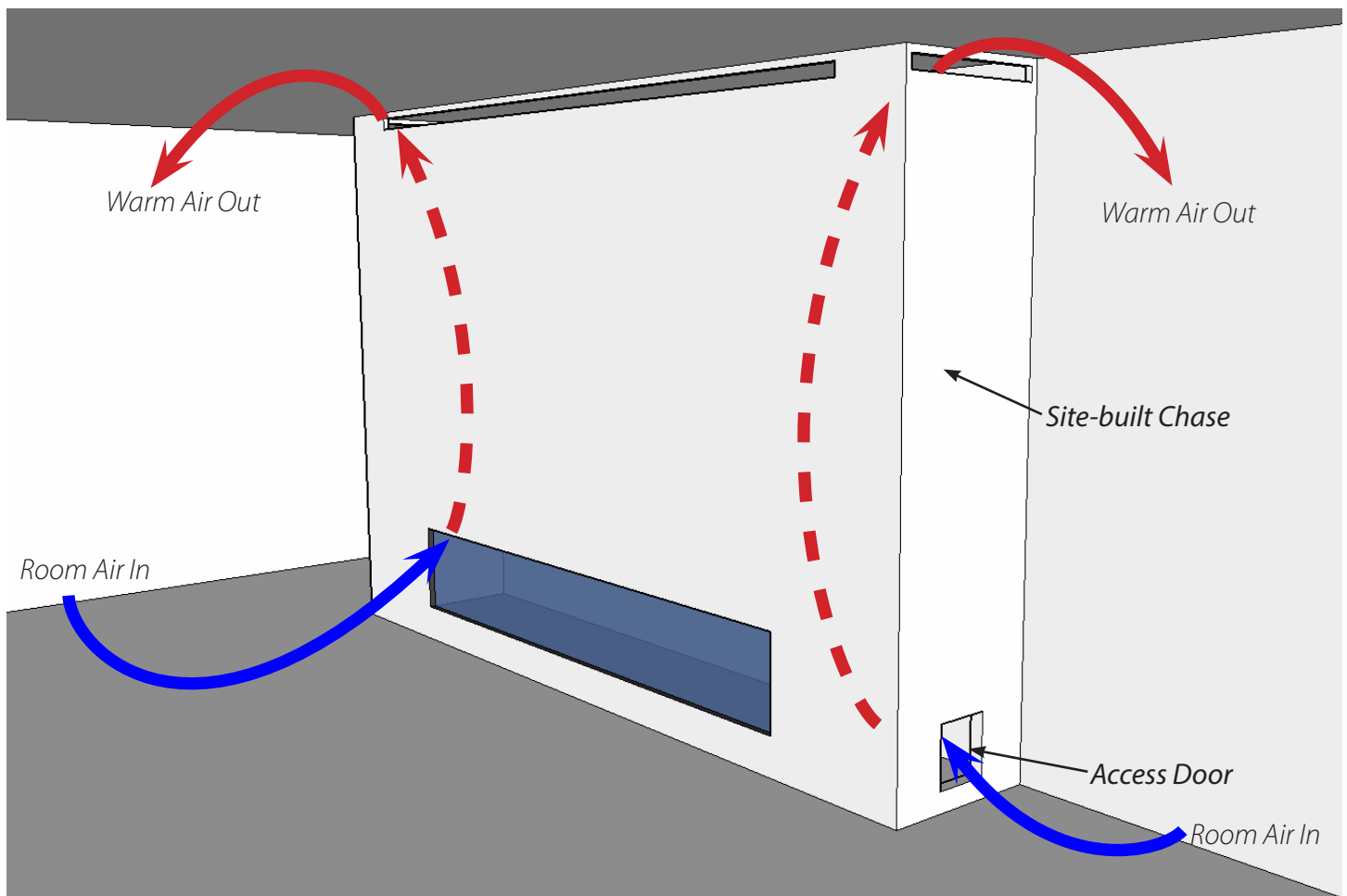

Figure 1

SPECIFICATIONS and DIMENSIONS

APPLIANCE RATINGS

Model		Modore 240 Tenore 240	
Gas		Natural Gas	Propane
Input Maximum	Btu/hr	89,100	64,700
Input Minimum	Btu/hr	25,900	19,500
Maximum Supply Pressure	in. w.c.	7	11
	kpa	1.74	2.74
Minimum Supply Pressure	in. w.c.	4	8
	kpa	1	2
Manifold Pressure Maximum	in. w.c.	4.0	10.8
	kpa	0.99	2.68
Manifold Pressure Minimum	in. w.c.	0.4	1.5
	kpa	0.1	0.38
Main Burner Injector Marking		1200 (x3)	220 (x3)
Pilot Injector Marking		31.2	27.1

AC ADAPTER SPECIFICATIONS	
Input Voltage	120V AC
Input Power	9 W
Output Voltage	6V DC
Output Current	500 mA
Size	3.1"H x 2"W x 1.7"D
Output Cord Length	6 Feet
Agency Approvals	UL, CSA



Figure 2 AC Adapter Connection (arrow)



SPECIFICATIONS and DIMENSIONS

<p>DO NOT REMOVE</p> <p>DIRECT VENT GAS FIREPLACE - Not for use with solid fuel.</p> <p>This appliance is only for use with the type of gas indicated on the rating plate and may be installed in an aftermarket, permanently located, manufactured home (USA only) or mobile home where not prohibited by local codes. See owner's manual for details. This appliance is not convertible for use with other gases, unless a certified kit is used.</p> <p>For use only with Vent, Glass Panels and Ceramic Logs (or stones) certified and approved for use with this appliance.</p> <p>This appliance must be installed in accordance with local codes, if any; if none, follow ANSI Z21.50/NFPA 54, or CSA B149.1. The appliance must be properly connected to a venting system in accordance with the manufacturer's installation instructions.</p> <p>The system must be installed by a qualified installing agency.</p>	<p>NE PAS RETIRER</p> <p>FOYER GAZ À AÉRATION DIRECTE - Ne pas utiliser avec un combustible solide</p> <p>Cet appareil est destiné uniquement avec le type de gaz indiqué sur la plaque signalétique et peut être installé dans une habitation en dur, à emplacement fixe (USA uniquement) ou dans une résidence mobile si la législation locale l'autorise. Consultez le manuel du propriétaire pour les détails. Cet appareil ne doit pas être modifié pour une utilisation avec d'autres gaz, sauf à l'aide d'un kit certifié.</p> <p>À utiliser uniquement avec des ventilations, panneaux en verre et poutres (ou pierres) en céramique dont l'utilisation est autorisée avec cet appareil.</p> <p>Cet appareil doit être installé conformément à la législation locale. À défaut d'une telle législation, suivre ANSI Z221.50/NFPA 54, ou CSA B149.1. L'appareil doit être correctement raccordé à un système de ventilation, conformément aux instructions d'installation du fabricant.</p> <p>Le système doit être installé par un installateur qualifié.</p>															
<p>Manufacturer / Fabricant: Element4 Paxtonstraat 23 NL-8013 RP Zwolle The Netherlands / Pays-Bas Tel / Tél : 0031 38 4209020 Fax:0031 38 4209021</p>	<p>Approved By / Approuvé par:</p> <p>Control No. / No. de contrôle: 4006611 Conformity to std. / Conforme à la norme: ANSI Z21.50a-2008 Approval No. / No. d'approbation: CSA 2.22a-2008 - Vented Gas Fireplaces</p> <p></p>															
<p>Product name: (check one) / Nom du produit: (cochez un)</p> <p>Trisore 100H [] Bidco 100H []</p> <p>Modore 100H []</p> <p>Serial No. / N° de série: _____</p>																
<p>This appliance equipped only for altitudes / Cet appareil est équipé uniquement pour les altitudes : 0-4500 ft / 0-1371 m</p>																
<p>Fuel Type / Type de combustible</p> <table border="0"> <tr> <td>(check one) / (cochez...)</td> <td>Natural Gas / Gaz naturel</td> <td>Propane / Gaz propane</td> </tr> <tr> <td></td> <td>[]</td> <td>[]</td> </tr> </table>		(check one) / (cochez...)	Natural Gas / Gaz naturel	Propane / Gaz propane		[]	[]									
(check one) / (cochez...)	Natural Gas / Gaz naturel	Propane / Gaz propane														
	[]	[]														
<table border="0"> <tr> <td>Max. Input / Capacité d'entrée maxi (BTU/HR)</td> <td>34145</td> <td>17145</td> </tr> <tr> <td>Min. Input / Capacité d'entrée mini (BTU/HR)</td> <td>15025</td> <td>17075</td> </tr> <tr> <td>Gas Inlet Pressure (in w.c.) / Pression d'entrée du gaz (en w.c.)</td> <td>7</td> <td>11</td> </tr> <tr> <td>Manifold Pressure (in w.c.) / Pression d'admission (en w.c.)</td> <td>2.1</td> <td>1.1</td> </tr> <tr> <td>Orifice Size / Taille de l'ouverture</td> <td>650 (x2)</td> <td>650 (x2)</td> </tr> </table>		Max. Input / Capacité d'entrée maxi (BTU/HR)	34145	17145	Min. Input / Capacité d'entrée mini (BTU/HR)	15025	17075	Gas Inlet Pressure (in w.c.) / Pression d'entrée du gaz (en w.c.)	7	11	Manifold Pressure (in w.c.) / Pression d'admission (en w.c.)	2.1	1.1	Orifice Size / Taille de l'ouverture	650 (x2)	650 (x2)
Max. Input / Capacité d'entrée maxi (BTU/HR)	34145	17145														
Min. Input / Capacité d'entrée mini (BTU/HR)	15025	17075														
Gas Inlet Pressure (in w.c.) / Pression d'entrée du gaz (en w.c.)	7	11														
Manifold Pressure (in w.c.) / Pression d'admission (en w.c.)	2.1	1.1														
Orifice Size / Taille de l'ouverture	650 (x2)	650 (x2)														
<p>Clearances to combustible / Dégagement jusqu'au combustible :</p> <table border="0"> <tr> <td>Back / Arrière : 11" (28cm)</td> <td>Sides / Côtés : 11" (28cm)</td> </tr> <tr> <td>Top / Haut : 26" (66cm)</td> <td>Floor / Sol : 4" (10cm)</td> </tr> <tr> <td>Mantel / Linteau: 2" (5cm)</td> <td></td> </tr> </table>		Back / Arrière : 11" (28cm)	Sides / Côtés : 11" (28cm)	Top / Haut : 26" (66cm)	Floor / Sol : 4" (10cm)	Mantel / Linteau: 2" (5cm)										
Back / Arrière : 11" (28cm)	Sides / Côtés : 11" (28cm)															
Top / Haut : 26" (66cm)	Floor / Sol : 4" (10cm)															
Mantel / Linteau: 2" (5cm)																

Figure 3 Typical Rating Label

A typical rating label is shown in Figure 3. It is attached to every Element4 fireplace and contains important certification information. It must not be removed from the fireplace.

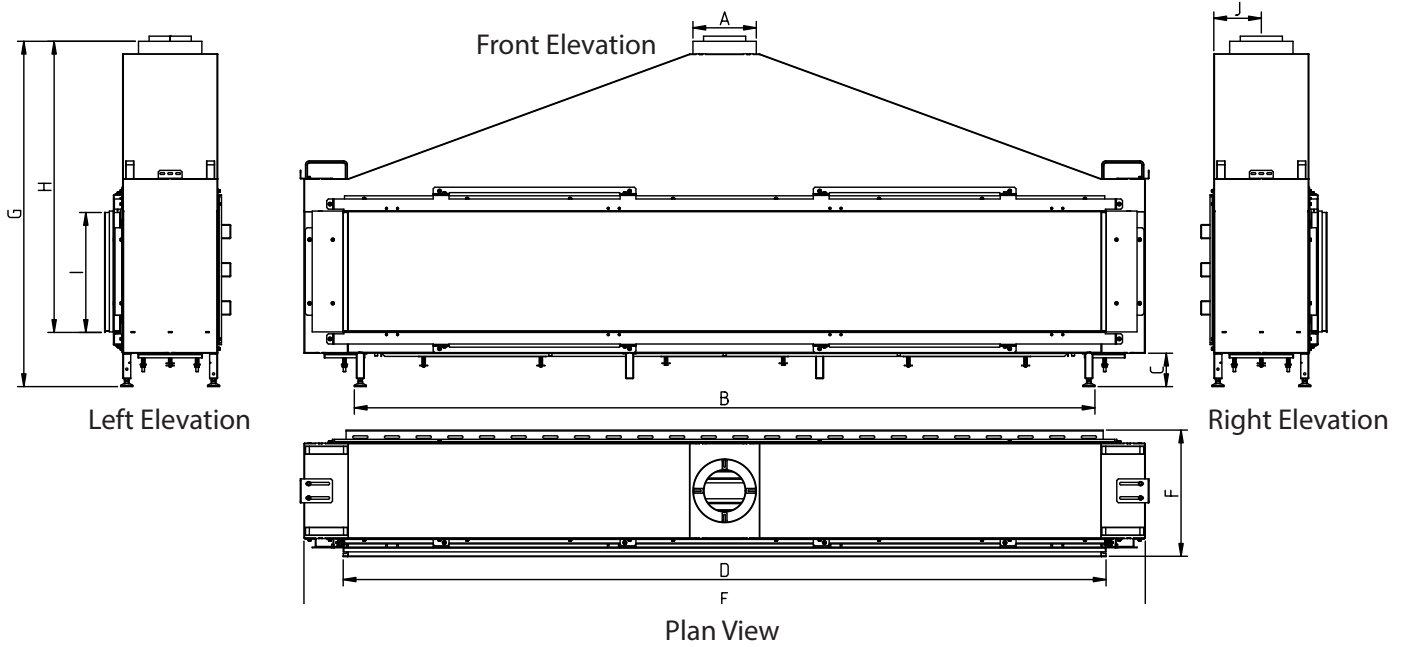

Letter	Inches	Millimeters
A	7 ⁷ / ₈	200
B	92 ¹ / ₆	2338
C	4	102
D	94 ¹³ / ₁₆	2408
E	104 ⁵ / ₈	2656
F	15 ⁵ / ₈	398
G	42 ¹³ / ₁₆	1086
H	36	915
I	14 ¹³ / ₁₆	377
J	5 ¹⁵ / ₁₆	150

MODORE 240

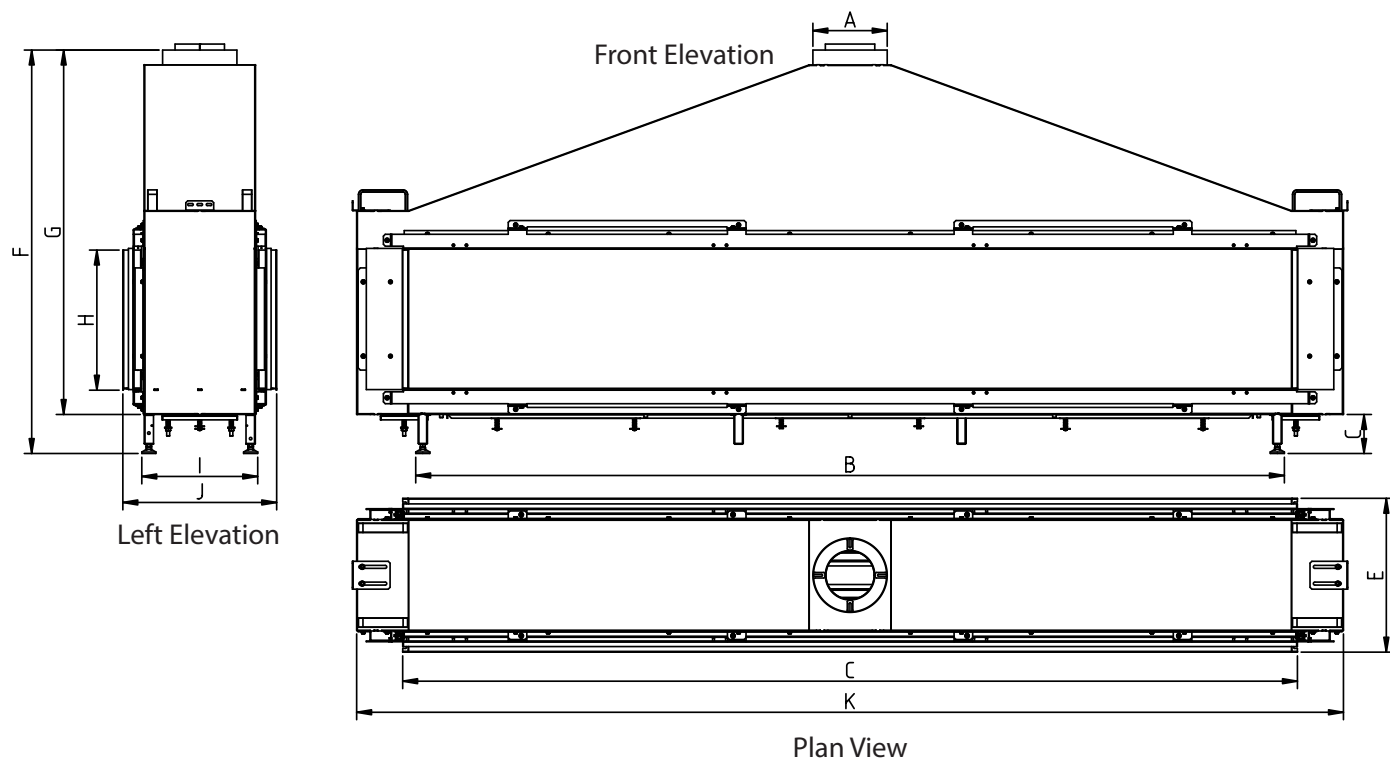

Letter	Inches	Millimeters
A	7 $\frac{7}{8}$	200
B	92 $\frac{1}{16}$	2338
C	94 $\frac{13}{16}$	2408
D	4 $\frac{3}{16}$	105
E	16 $\frac{5}{16}$	413
F	42 $\frac{13}{16}$	1086
G	38 $\frac{5}{8}$	981
H	14 $\frac{3}{4}$	374
I	12 $\frac{5}{16}$	312
J	16 $\frac{5}{16}$	413
K	104 $\frac{5}{8}$	2656

TENORE 240

SPECIFICATIONS and DIMENSIONS

PARTS OF THE FIREPLACE

Parts of the Modore 240 fireplace are shown in Figures 4, 5 and 6. These parts are also in the Tenore 240.

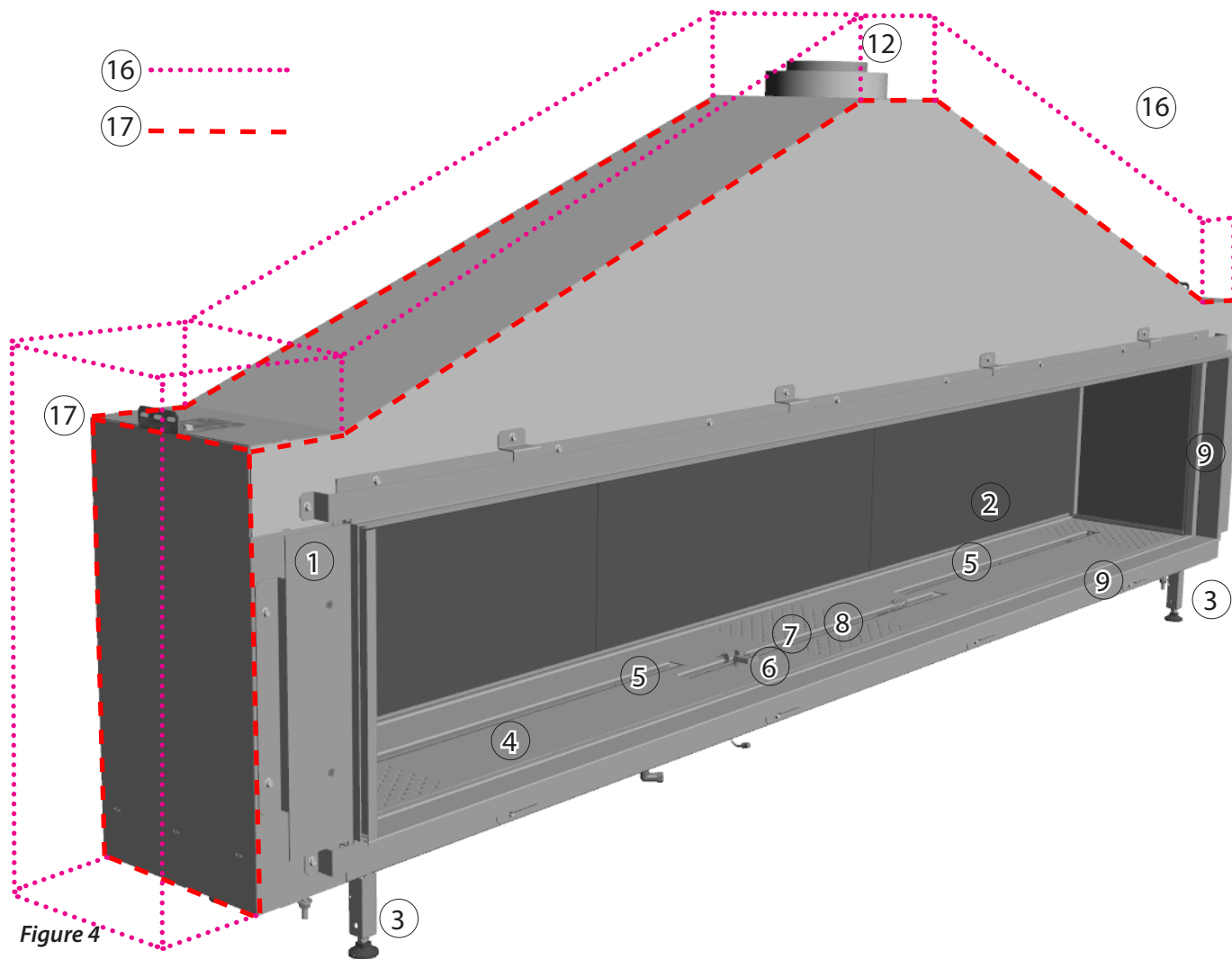

Figure 4

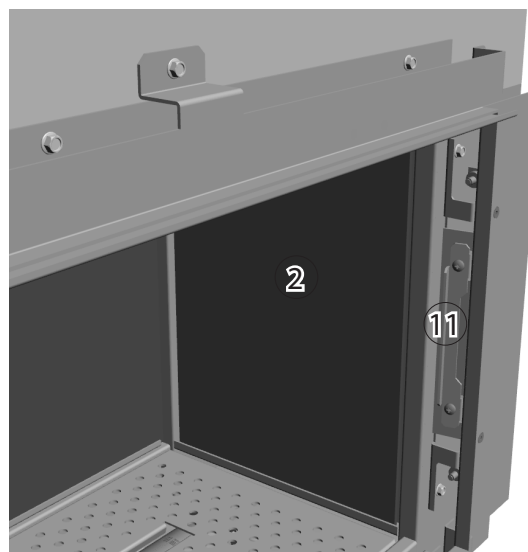

Figure 5

SPECIFICATIONS and DIMENSIONS

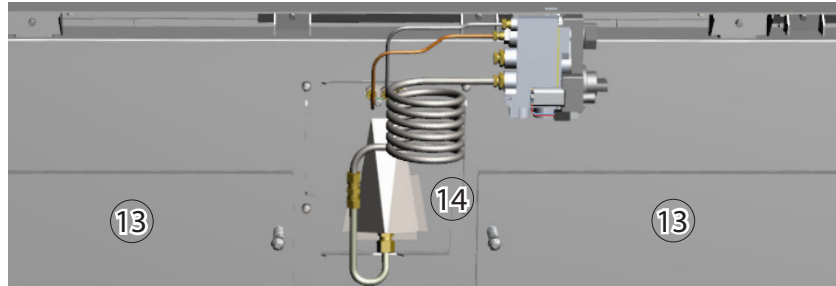

Figure 6

Figure 6 shows a view from below.

Table of Fireplace Parts	
①	Outer Frame Face- surrounds the glass panels and limits the non-combustible wall board
②	Exterior Glass Panel - 1 or 2 depending on model
③	Support Feet - six adjustable feet allow the fireplace to be levelled
④	Hearth Panel - supports various Fire Media
⑤	Primary Burner - produces the main flame
⑥	Secondary Burner - produces the second flame; may be controlled separately
⑦	Pilot Burner - the part of the safety circuit which lights the Main Burner
⑧	2 nd Thermocouple - the part of the safety circuit which monitors the Main Burner
⑨	Finish Trim - hides the Glass Clamps
⑩	Interior Glass Panel (N/A - Modore 240, 1 - Tenore 240)
⑪	Glass Clamp - holds the Glass Panel in place (2 ea. - Modore 240, 4 ea. - Tenore 240)
⑫	Vent Collar - accepts the 5" x 8" venting adapter (included)
⑬	Relief Door - part of the safety system. Do NOT block the operation.
⑭	Pilot Assembly
⑮	Upright Trim - (2 ea. - Modore 240, 4 ea. - Tenore 240 hides the vertical Glass Clamps)
⑯	No material zone
⑰	Top of fireplace
⑱	Flange

Table 1

CLEARANCES

The Modore 240 and Tenore 240 fireplaces require non-combustible framing. These are **NOT** zero-clearance fireplaces. All clearances to combustible AND non-combustible materials **MUST** be maintained as described in this manual.

LOCATING THE FIREPLACE

When selecting a location for the fireplace:

- Ensure that all minimum clearances to combustible AND non-combustible materials are met.
- Provide adequate clearances for servicing.
- Consider venting dimensions (rise, run and number of elbows, etc.) when selecting the location for your fireplace.
- Locate the appliance out of traffic and away from furniture and draperies.
- Keep the location free of electrical, plumbing or other heating/air conditioning ducting.

PLACING THE FIREPLACE

The base upon which the appliance rests must be sturdy, level and built to safely support at least 500 pounds/230 kilograms. The base may be the floor or a purpose built raised platform (e.g. wood, metal). The base upon which the fireplace is installed must have a 25 in.²/161 cm² opening centered in it to allow the free flow of air to the fireplace above unless placed on a floor. See below.

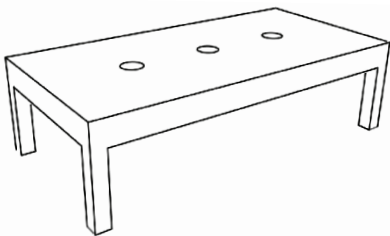

The feet on the appliance are designed to sit on a flat platform, however the appliance must not be installed on any combustible material other than wood. For example, carpet or linoleum bases are not permitted.

Do not place anything between the bottom of the firebox and the bottom of the feet. Ensure that the lineset (which includes the gas valve, electrical wiring, and gas lines) does not impede the full operation of the relief doors.

MINIMUM CLEARANCE TO COMBUSTIBLES

- The appliance is approved with a minimum clearance to combustible materials of 26"/660 mm to the top, 11"/280 mm on all sides and 4"/100 mm to the bottom. Any spacer or framing used closer than this dimension must be non-combustible (e.g. metal).
- The minimum clearance to non-combustible material is 2"/50 mm. (See Figures 7 - 12, clearance shown in red)
- The minimum distance from the bottom of the appliance to the room ceiling is 72"/1830 mm. (See Figure 15, Table 2)
- When installing the venting the following clearances to combustible materials **MUST** be maintained:
 - a. 3"/76 mm above any horizontal venting
 - b. 1"/25 mm to venting sides or below any horizontal venting
- Non-combustible materials may be installed to a zero clearance, to the outer faces of the appliance outer frame. However, they must not cover (or prevent the removal of) the glass panels or the control equipment.
- Do not block or restrict the convection gap between the appliance firebox and the appliance outer frame (top of glass panels).

The minimum clearances (air spaces) to combustible materials must be maintained. It is of the greatest importance that the fireplace and vent system be installed only in accordance with these instructions.

Clearance to combustibles summary:

Back:	11"/280 mm
Sides:	11"/280 mm
Top:	26"/660 mm
Floor:	4"/100 mm

The **Floor** dimension (above) is measured from the bottom of the firebox. This allows the feet to sit on the floor giving adequate clearance in their lowest position.

MODORE 240

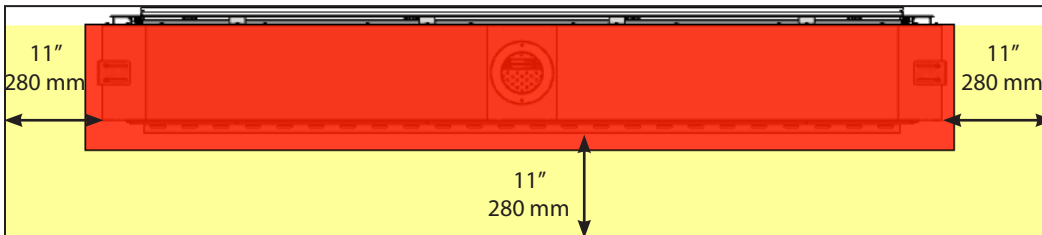

Figure 7 Plan View - Modore 240

Figures 7* through 9* show (in yellow) the clearances to combustible material which *must* be maintained.

No material of any kind is allowed between the bottom of the support feet and the bottom of the firebox (shown in red).

No material of any kind is allowed within 2"/50 mm from the top of the fireplace (shown in red).

No material of any kind is allowed within 2"/50 mm from the metal sides the fireplace (shown in red).

Facing material should be installed against the outer frame of the fireplace, with an 1/8" vertical clearance to allow for heat expansion.

*drawings not to scale

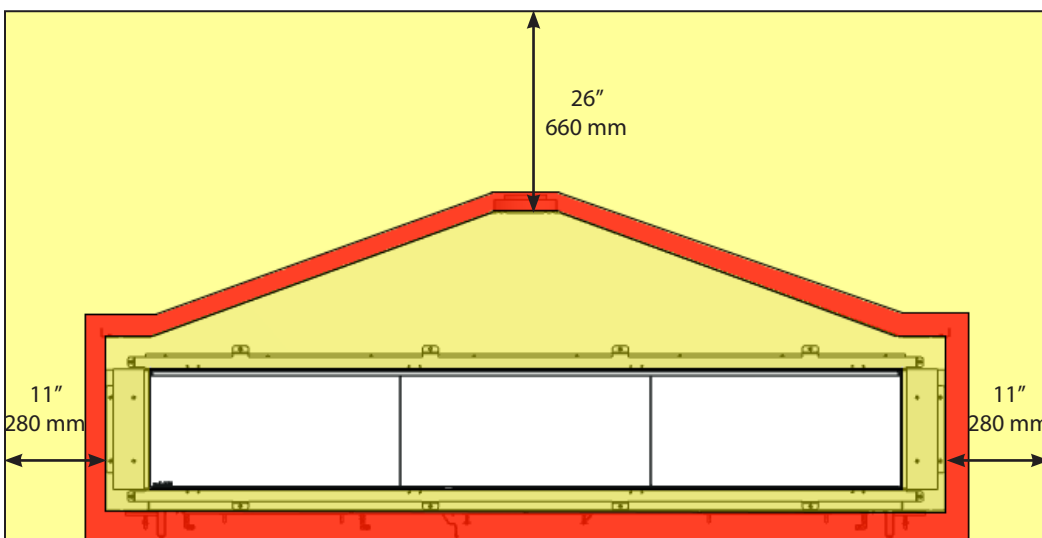

Figure 8 Front Elevation View - Modore 240

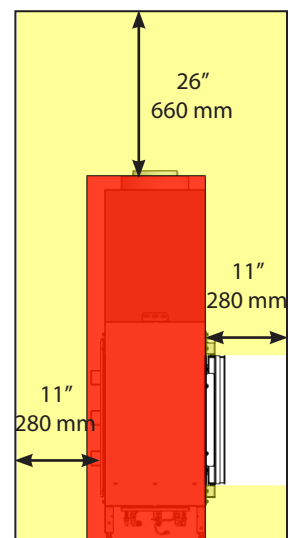

Figure 9 Side Elevation View - Modore 240

TENORE 240

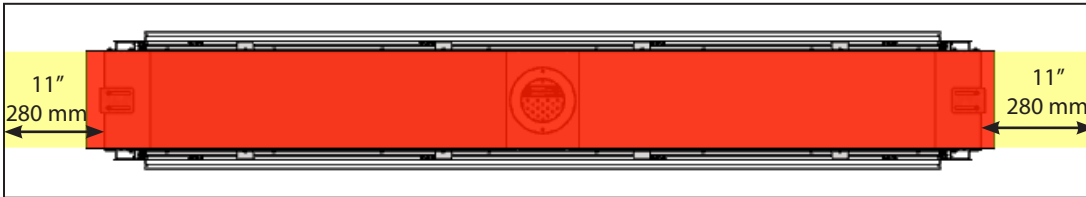

Figure 10 Plan View - Tenore 240

Figures 10* through 12* show (in yellow) the clearances to combustible material which *must* be maintained.

No material of any kind is allowed between the bottom of the support feet and the bottom of the firebox (shown in red).

No material of any kind is allowed within 2"/50 mm from the top of the fireplace (shown in red).

No material of any kind is allowed within 2"/50 mm from the metal sides the fireplace (shown in red).

Facing material should be installed against the outer frame of the fireplace, with an 1/8" vertical clearance to allow for heat expansion.

*drawings not to scale

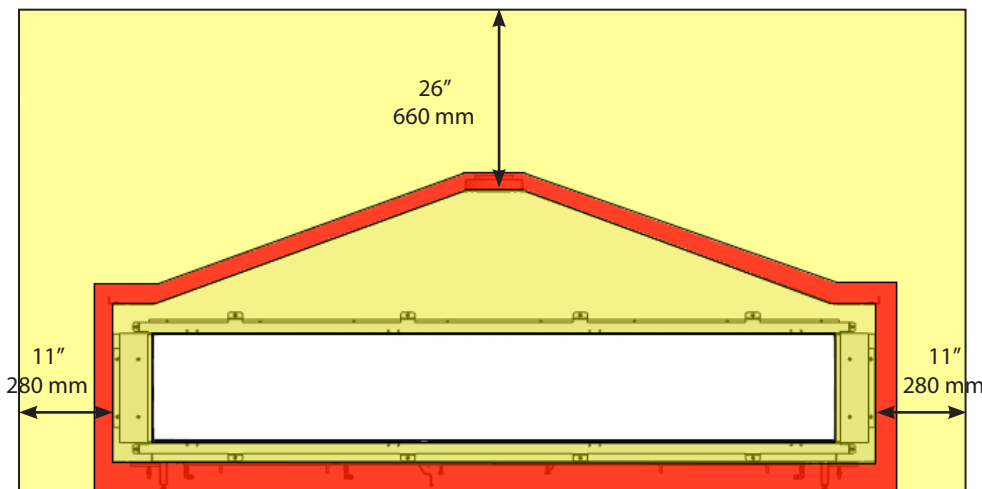

Figure 11 Front Elevation View - Tenore 240

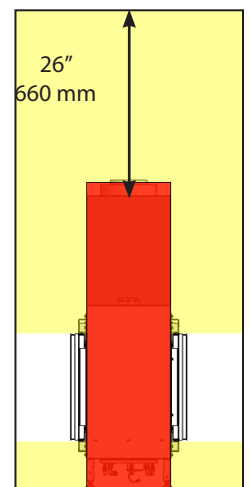

Figure 12 Side Elevation View - Tenore 240

CLEARANCES

MANTELS

The graph in Figure 13 shows a range of allowable depths and heights for a *combustible* mantel installation.

As shown, the minimum allowable mantel height above the fireplace opening is 2"/50 mm with a 1"/25 mm deep mantel.

The maximum mantel depth is 12"/300 mm at a minimum height above the fireplace opening of 13"/330 mm.

All of the mantel height/depth combinations fall in between these extremes in accordance with Figure 13.

Mantels made of *non-combustible* material are allowed inside these dimensions but they will be subjected to elevated temperatures and may become too hot to touch.

A typical completed installation with mantel is shown in Figure 14.

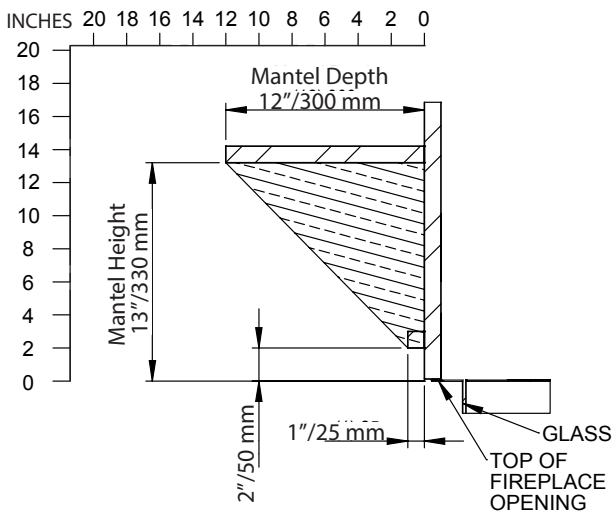

Figure 13

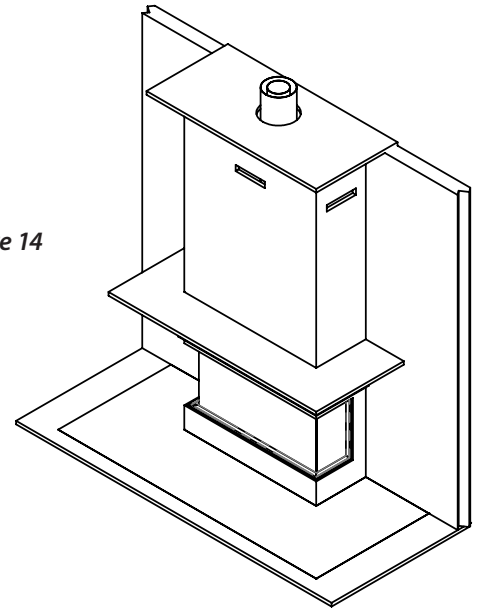

Figure 14

CLEARANCES

TYPICAL CLEARANCE DIAGRAMS

The total area of the convection air outlet(s) depends on the fireplace model. The location of the outlet(s) must allow for the free movement of air and must not allow excessive convection air to build up within the chase. The top of the outlet(s) must be at least 1"/25 mm down from the ceiling and we recommend no more than 3"/76 mm down. The minimum distance from the bottom of the appliance to the room ceiling is 72"/1830 mm.

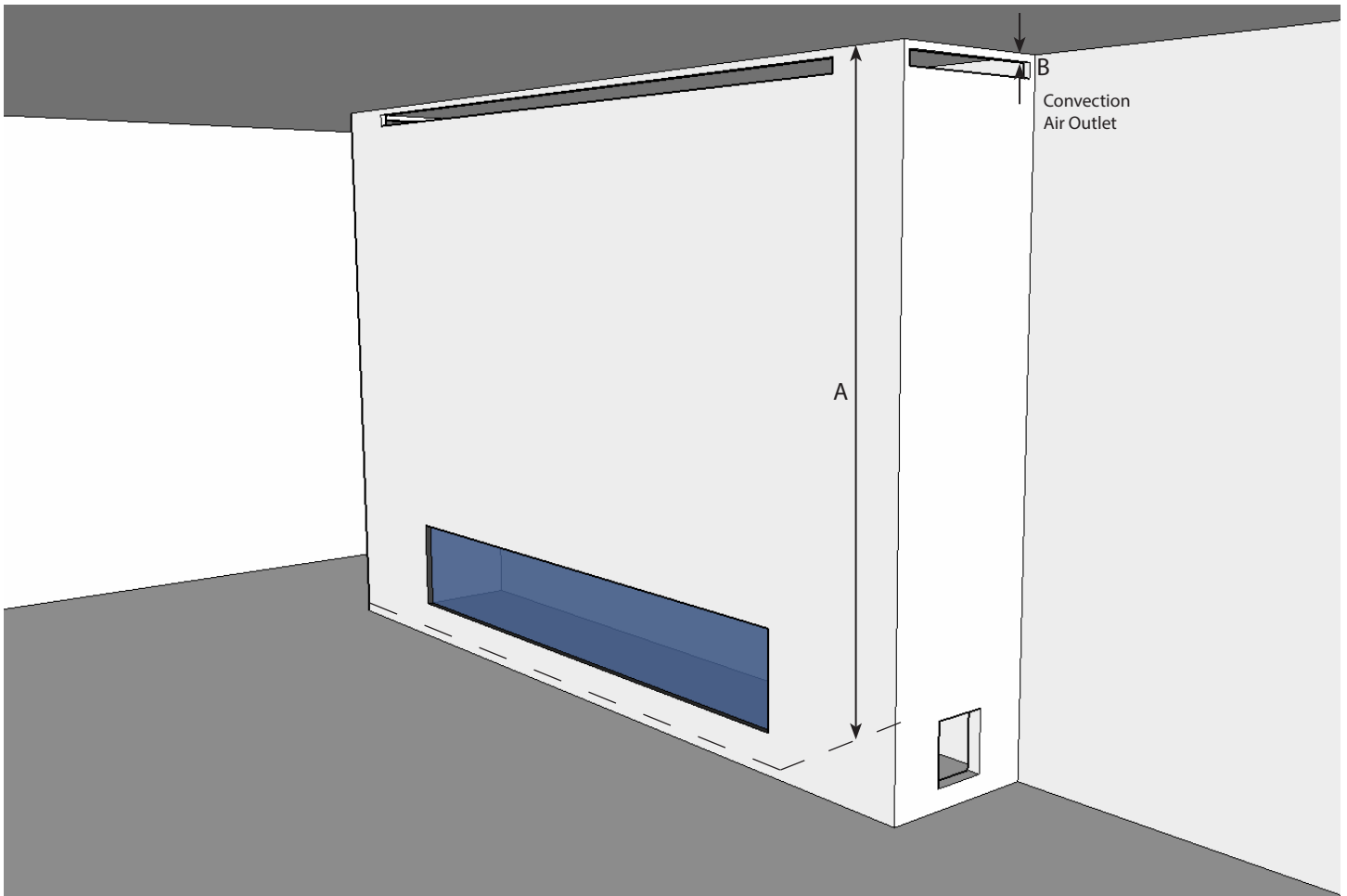

Figure 15

Minimum Distances		
A	Room ceiling to appliance bottom	72" 1830 mm
B	Room ceiling to top of Convection Air Outlet	1" 25 mm

Table 2

Convection Air Outlet Area by Model		
Model	Square Inches	Square Centimeters
Modore 240	102	658
Tenore 240	204	1316

Table 3

GAS and ELECTRIC

INSTALLING THE GAS LINE

Correctly size and route the gas supply line from the supply regulator to the area where the appliance is to be installed as per requirements outlined in the latest edition of the National Fuel Gas Code, NFPA 54 (USA) or CAN/CSA-B149.1 (Canada).

Never use galvanized or plastic pipe unless specified for use with gas. Refer to the table below for proper sizing of the supply gas line. Gas lines must be routed, constructed and made of materials that are in strict accordance with local codes and regulations. A qualified plumber or gas fitter should be hired to correctly size and route the gas supply line to the appliance.

Installing a gas supply line from the fuel supply to the appliance involves numerous considerations of materials, protection, sizing, locations, controls, pressure, sediment trap, and other criteria. The sizing and/or installing of gas piping should only be performed by a qualified plumber or gasfitter.

The gas control inlet accepts a $\frac{3}{8}$ " NPT fitting.

This fireplace arrives from the factory for use with natural gas. See Appendix Three for LP (propane) conversion instructions.

Schedule 40 Black Iron Pipe		
	Natural Gas	Propane Gas
Length (feet)	Inside Diameter (Inches)	
0 - 10	$\frac{1}{2}$	$\frac{3}{8}$
10 - 40	$\frac{1}{2}$	$\frac{1}{2}$
40 - 100	$\frac{1}{2}$	$\frac{1}{2}$
100 - 150	$\frac{3}{4}$	$\frac{1}{2}$
150 - 200	$\frac{3}{4}$	$\frac{1}{2}$

Table 4

ELECTRICAL REQUIREMENTS

The Element4 fireplaces use a receiver and remote control for their burner operation. The remote control comes with (3) AAA batteries and the receiver is powered by a 120V AC adapter, included.

The installer must provide an approved 120V AC wall receptacle to be placed within the six foot cord limit of the AC adapter.

The receiver may be powered by *either* the AC adapter *or* (4) AA batteries - **not both**. **Batteries do not provide an electrical backup for the AC adapter. Using batteries in combination with the AC adapter can damage the receiver.**



WARNING

Electrical work must be performed by a qualified, licensed electrician.

All wiring shall be in compliance with all local, city, and state codes.

VENTING

CONFIGURING THE VENTING

The fireplaces in this manual are direct vent fireplaces that use a co-axial or “pipe within a pipe” venting system. The outer “pipe” or vent conducts fresh, outside air into the fireplace and the inner vent carries the exhaust outside. This system, which can run either horizontally through a side wall or vertically through the roof, produces an efficient system because conditioned building air is not used for combustion.

All of the following points apply to every installation:

- The maximum allowable rise is 36’/11.0 m and the maximum allowable run is 9’10”/3.0 m but not in combination; see venting charts.
- The minimum vent configuration is a 39”/1.0 m vertical rise to a 90° elbow plus a 19”/0.5 m horizontal run to a wall termination.
- Only the 5” x 8” direct vent components from M&G DuraVent are approved for use with these fireplaces. Any of the M&G DuraVent 5” x 8” direct vent components suitable for the local condition are permitted. Please visit www.europeanhome.com/qr-support or via the QR code below for installation instructions.
- This fireplace is shipped with a North American venting adapter. It MUST attach to the vent collar of the fireplace.
- All venting measurements are taken from the top center of the vent collar on the top of the fireplace and all configurations must fall within the acceptable range of the venting charts.
- When using wall terminations no more than three vertically-oriented 45° or 90° elbows are permitted. See the **HORIZONTAL TERMINATIONS** section.
- When using vertical terminations no more than four 90° elbows OR eight 45° elbows OR a combination totaling no more than 360 ‘elbow degrees’. For example, a combination of two 90° elbows and two 45° elbows is allowed (90° + 90° + 45° + 45° equals 270°) but a combination of three 90° elbows and three 45° elbows is not allowed (the total equals 405°.) These elbows can be installed either horizontally or vertically.
- A minimum clearance of 3”/75 mm must be maintained between combustible materials and the top of any horizontal vent pipe surface; a minimum clearance of 1”/25 mm must be maintained between combustible materials and any other vent pipe surface.
- The horizontal parts of the venting must be pitched up, away from the fireplace. For every 12” / 305 mm of horizontal run, the venting must rise ¼” / 6.5 mm toward the termination. The venting must never run downward unless with the use of a power vent.
- Whenever venting passes through a wall, an approved heat shield or ‘wall thimble’ must be installed.
- A power vent system is available and must be used for any venting configuration which is outside of the vent graphs.

For the M&G venting installation guide or power venting installation manuals please visit the link below.



VENTING

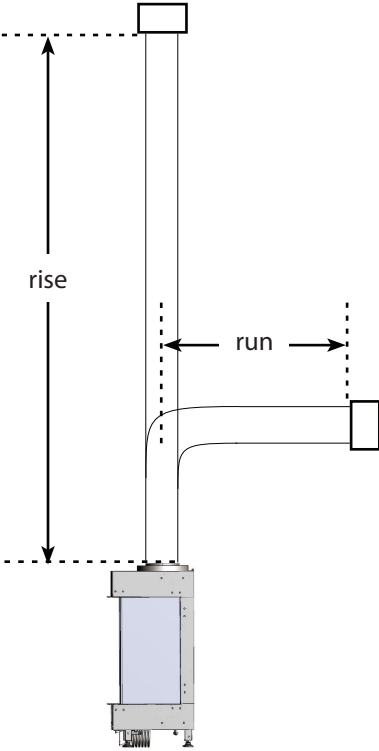
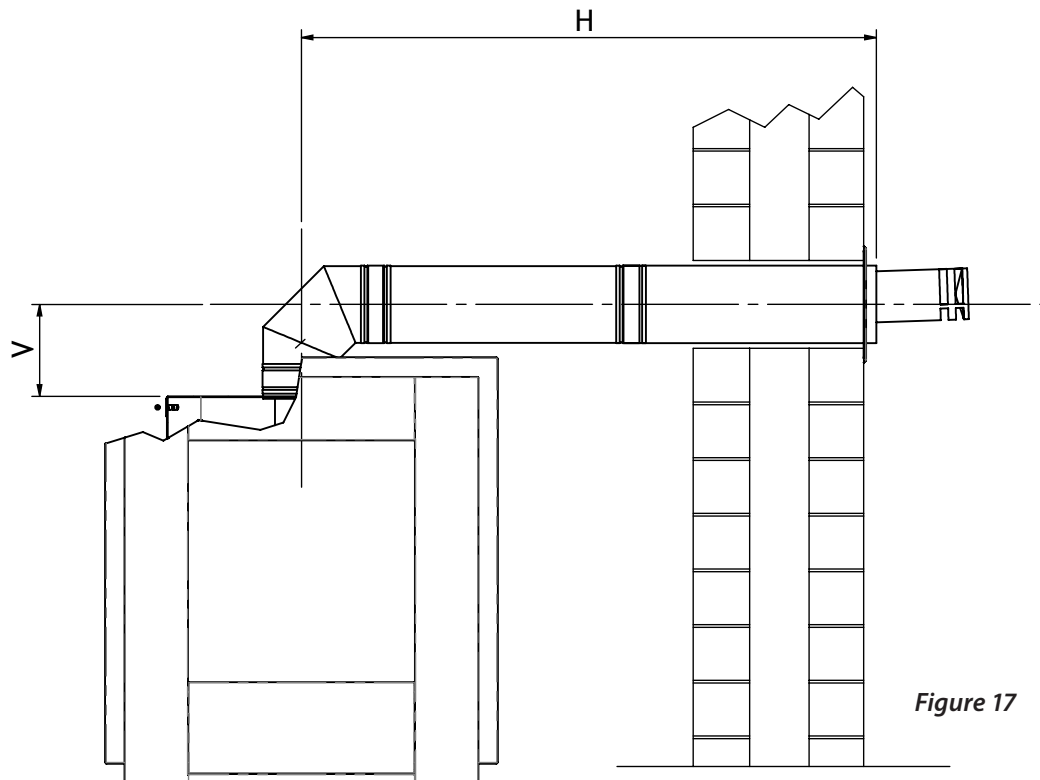

Figure 16

APPROVED MANUFACTURERS and COMPONENTS	
<i>Manufacturer</i>	<i>Components</i>
M&G DuraVent, Inc.*	only DirectVent Pro® 5" x 8" venting components

Table 5

HORIZONTAL TERMINATIONS



Dimension "H" (run) can vary between 19"/500 mm minimum to 9'10"/3.0 m maximum depending on Dimension "V". (See Graph 1)

Dimension "V" (rise) can vary between 3'3"/1.0 m minimum to 23'/7.0 m maximum depending on Dimension "H". (See Graph 1)

HORIZONTAL TERMINATIONS

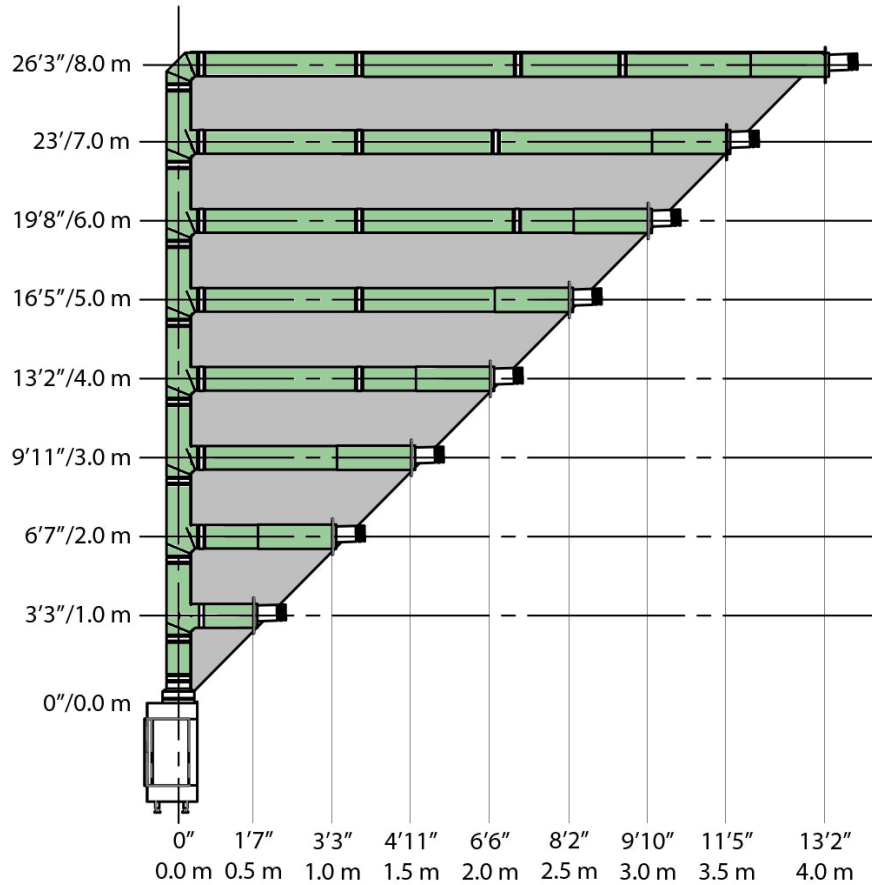

Graph 1 Horizontal Termination Graph

Graph 1 shows the maximum horizontal vent run (to the outside wall) for the corresponding vertical vent rise. The allowable venting configuration **MUST** be within the shaded area. A power vent system is available for configurations which are not allowed by these requirements.

- When using a wall-mounted termination, a maximum of **3** elbows (45° or 90°) may be used.
- For each second or third elbow:
 - 20"/500 mm must be subtracted from the horizontal length allowance when using a 45° elbow
 - 40"/1000 mm must be subtracted from the horizontal length allowance when using a 90° elbow

Example A: With a total rise of 13'2"/4.0 m and one horizontal 90° elbow, a total run of 6'6"/2.0 m is allowed.

Example B: If the rise is 19'8"/6.0 m then the run can be no longer than 9'10"/3.0 m.

Example C: If the run is 13'2"/4.0 m then the rise must be at least 26'3"/8.0 m.

HORIZONTAL VENT TERMINATION CLEARANCES AND REQUIREMENTS

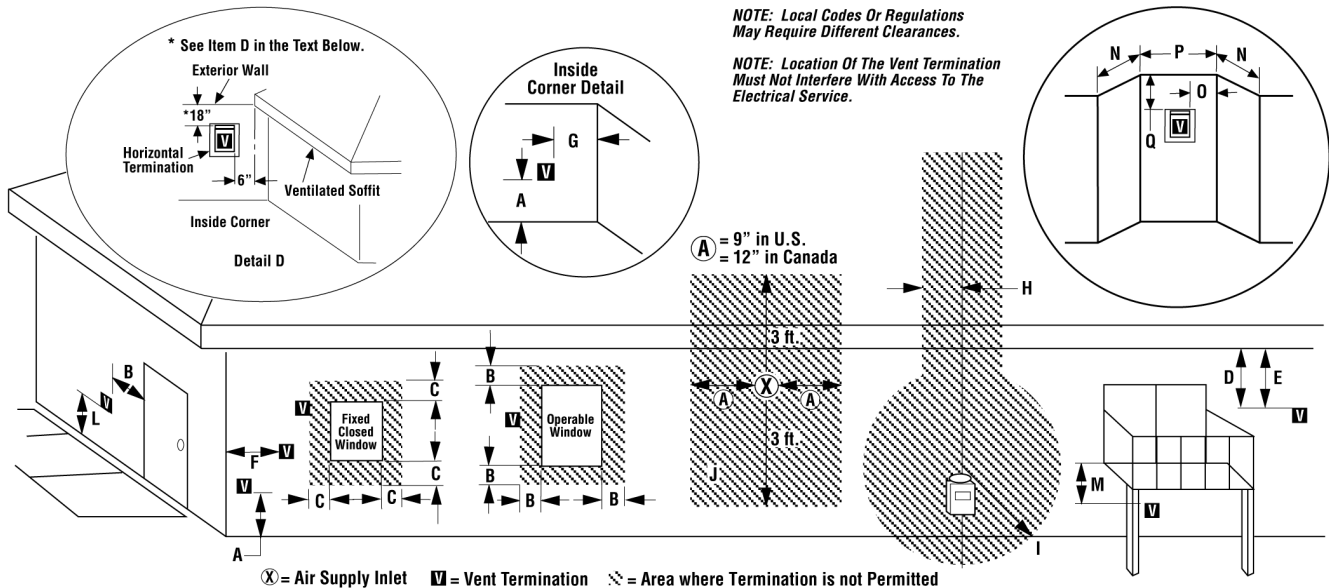

	Canadian Installation*	US Installation**
A = Clearance above grade, veranda, porch, deck, or balcony.	12 inches (30cm)*	12 inches (30cm)**
B = Clearance to window or door that may be opened.	6 inches (15cm) for appliances < 10,000 Btuh (3kW), 12 inches (30cm) for appliances > 10,000 Btuh (3kW)	6 inches (15cm) for appliances < 10,000 Btuh (3kW), 9 inches (23cm) for appliances > 10,000 Btuh (3kW) and < 50,000 Btuh (15kW), 12 inches (30cm) for appliances > 50,000 Btuh (15kW)**
C = Clearance to permanently closed window	12 inches (305mm) recommended to prevent window condensation	9 inches (229mm) recommended to prevent window condensation
D = Vertical clearance to ventilated soffit located above the termination within a horizontal distance of 18 inches (458mm) from the center line of the termination	18 inches (458mm)	18 inches (458mm)
E = Clearance to unventilated soffit	12 inches (305mm)	12 inches (305mm)
F = Clearance to outside corner	5 inches (12.7cm) minimum	5 inches (12.7cm) minimum
G = Clearance to inside corner	2 inches (5.08cm) minimum - SV4.5HT-2	2 inches (5.08cm) minimum - SV4.5HT-2
H = Clearance to each inside of center line extended above meter/regulator assembly	3 feet (91cm) within a height of 15 feet above the meter/regulator assembly*	3 feet (91cm) within a height of 15 feet above the meter/regulator assembly**
I = Clearance to service regulator vent outlet	3 feet (91cm)*	3 feet (91cm)**
J = Clearance to nonmechanical air supply inlet to building or the combustion air inlet to any other appliance	6 inches (15cm) for appliances < 10,000 Btuh (3kW), 12 inches (30cm) for appliances > 10,000 Btuh (3kW)	6 inches (15cm) for appliances < 10,000 Btuh (3kW), 9 inches (23cm) for appliances > 10,000 Btuh (3kW) and < 50,000 Btuh (15kW), 12 inches (30cm) for appliances > 50,000 Btuh (15kW)**
K = Clearance to a mechanical air supply inlet	6 feet (1.83m)*	3 feet (91cm) above if within 10 feet (3m) horizontally**
L = Clearance above paved sidewalk or paved driveway located on public property	7 feet (2.13m)‡	7 feet (2.13m)‡
M = Clearance under veranda, porch, deck or balcony	12 inches (30cm)*‡	12 inches (30cm)‡
N = Depth of Alcove (Maximum)	6 feet (1.83m)*	6 feet (1.83m)**
O = Clearance to Termination (Alcove)	6 inches (15.2mm)*	6 inches (15.2mm)**
P = Width of Alcove (Minimum)	3 feet (91cm)*	3 feet (91cm)*
Q = Clearance to Combustible Above (Alcove)	18 inches (457mm)*	18 inches (457mm)**
* In accordance with the current CSA-B149.1 National Gas And Propane Installation Code.		
** In accordance with the current ANSI S223.1/NFPA 54 National Fuel Gas Codes.		
‡ A vent shall not terminate directly above a sidewalk or paved driveway which is located between two single family dwellings and serves both dwellings.		
*‡ Only permitted if veranda, porch, deck or balcony is fully open on a minimum 2 sides beneath the floor:		

VERTICAL TERMINATIONS

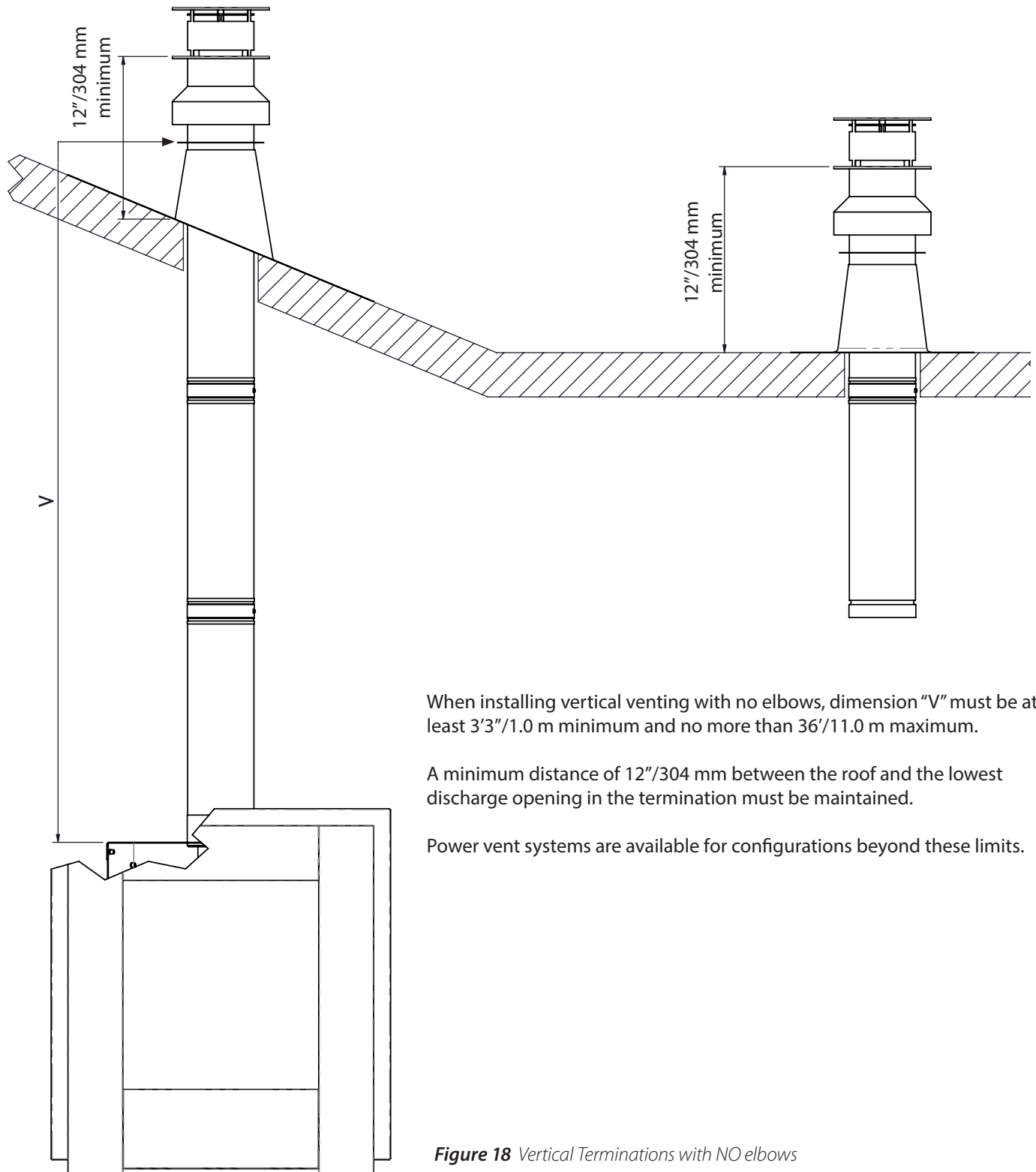

When installing vertical venting with no elbows, dimension "V" must be at least 3'3"/1.0 m minimum and no more than 36'/11.0 m maximum.

A minimum distance of 12"/304 mm between the roof and the lowest discharge opening in the termination must be maintained.

Power vent systems are available for configurations beyond these limits.

Figure 18 Vertical Terminations with NO elbows

VERTICAL TERMINATIONS WITH 90° ELBOWS

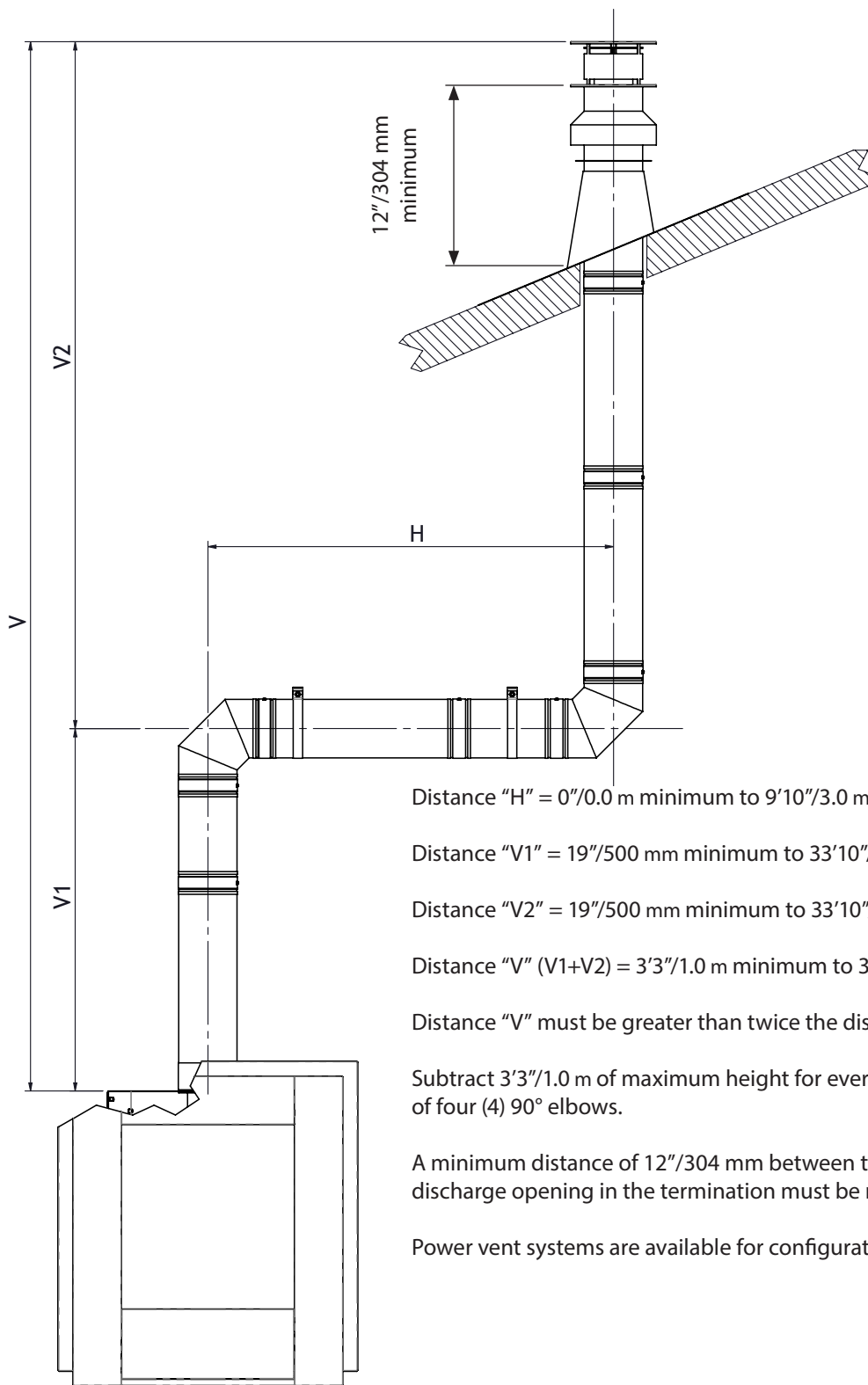

Distance "H" = 0"/0.0 m minimum to 9'10"/3.0 m maximum

Distance "V1" = 19"/500 mm minimum to 33'10"/10.0 m maximum

Distance "V2" = 19"/500 mm minimum to 33'10"/10.0 m maximum

Distance "V" (V1+V2) = 3'3"/1.0 m minimum to 36'/11.0 m maximum

Distance "V" must be greater than twice the distance of "H"

Subtract 3'3"/1.0 m of maximum height for every 90° elbow up to a maximum of four (4) 90° elbows.

A minimum distance of 12"/304 mm between the roof and the lowest discharge opening in the termination must be maintained.

Power vent systems are available for configurations beyond these limits.

Figure 19 Vertical Terminations with 90° elbows

VERTICAL TERMINATIONS WITH 45° ELBOWS

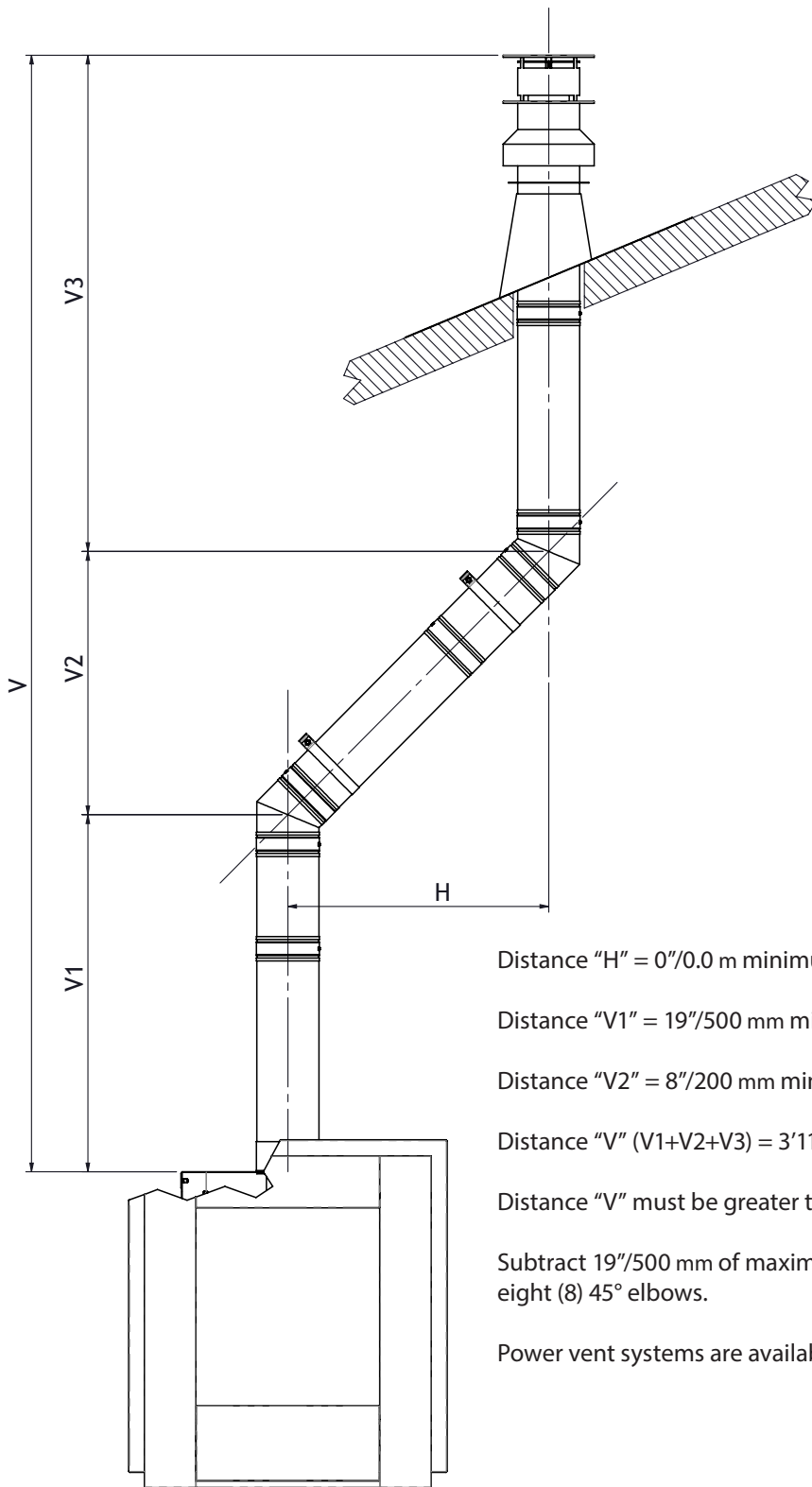

Distance "H" = 0"/0.0 m minimum to 9'10"/3.0 m maximum

Distance "V1" = 19"/500 mm minimum to 33'10"/10.0 m maximum

Distance "V2" = 8"/200 mm minimum to 33'10"/10.0 m maximum

Distance "V" (V1+V2+V3) = 3'11"/1.2 m minimum to 36'/11.0 m maximum

Distance "V" must be greater than twice the distance of "H"

Subtract 19"/500 mm of maximum height for every 45° elbow up to a maximum of eight (8) 45° elbows.

Power vent systems are available for configurations beyond these limits.

Figure 20 Vertical Terminations with 45° elbows

VERTICAL TERMINATION CLEARANCES AND REQUIREMENTS

Important Note for Roof Terminations

These instructions should be used as a guideline and do not supersede local codes in any way. Install venting according to local codes, these instructions, the current National Fuel Gas Code (ANSI Z223.1 in the USA) or the current standard of CAN/CSA-B149.1 in Canada.

Vertical Vent Termination Clearances

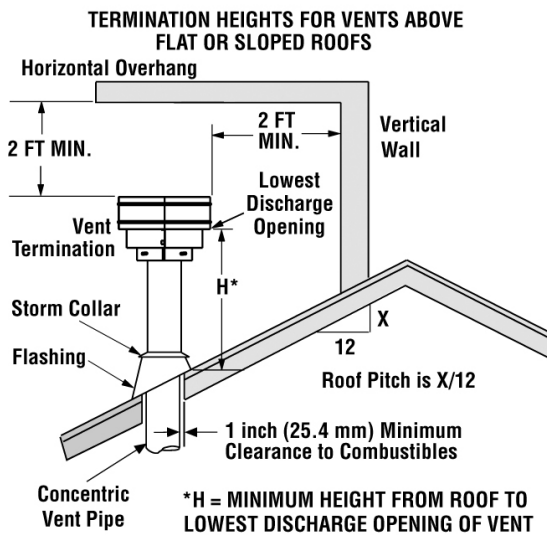

The vent / air intake termination clearances above the high side of an angled roof is as shown in the following chart:

Termination Heights For Vents Above Flat Or Sloped Roofs Ref. NFPA 54 / ANSI Z223.1		
Roof Pitch	* Feet	* Meters
Flat to 6/12	1.0	0.3
6/12 to 7/12	1.25	0.38
7/12 to 8/12	1.5	0.46
8/12 to 9/12	2.0	0.61
9/12 to 10/12	2.5	0.76
10/12 to 11/12	3.25	0.99
11/12 to 12/12	4.0	1.22
12/12 to 14/12	5.0	1.52
14/12 to 16/12	6.0	1.83
16/12 to 18/12	7.0	2.13
18/12 to 20/12	7.5	2.29
20/12 to 21/12	8.0	2.44

Chart 1 Termination Heights

A second termination may be no closer than 12"/305 mm. (See Figure 21)

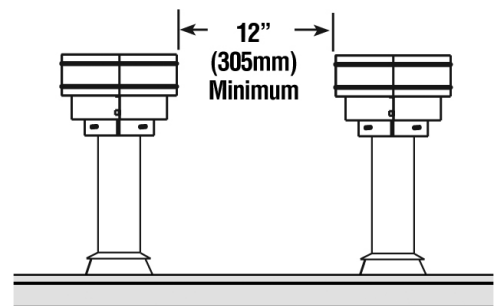

Figure 21 Multiple Termination Clearance

ENCLOSING the FIREPLACE



When enclosing your Element4 fireplace the use of non-combustible building materials is **REQUIRED**. Please read and understand the following.

COMBUSTIBLE MATERIALS

Materials that can catch fire and burn are considered combustible. Any material that is made of, or faced with, wood, wood pulp, paper, plastic or any other material that can catch fire and burn is considered combustible. Even though these materials may have been 'flame-proofed', made 'fire-resistant' or are 'fire-rated' they are considered combustible. Standard and Type X drywall are both combustible.

NON-COMBUSTIBLE MATERIALS

A given material is said to be non-combustible when it cannot catch fire and burn. For example, materials made entirely, or in combinations, of, stone, brick, concrete, tile, steel, plaster or glass are considered non-combustible.

The table below shows a list of materials which, as of this writing, are reported by their manufacturers to be non-combustible (in accordance with the ASTM E136 standard) **AND** approved for use around fireplaces.

Skamol Skamotec® 225 and Promat PROMATECT®-L are preferred products for enclosing fireplaces.

Product*
Skamol Skamotec® 225 Fireplace Building Board
Promat PROMATECT®-L Insulating Boards
James Hardie Building Products HardieBacker® 500 ½" Cement Board
James Hardie Building Products HardieBacker® ¼" Cement Board
U.S. Architectural Products Versaroc® Cement Bonded Particle Board
U.S. Architectural Products Cem-Clad® Cement Panel

* The listed brand names are trademarks of their respective companies

¹ Skamol Americas, Inc.
Toll Free: (844) 475-2665
E-mail: skamotec225@skamol.com
www.skamotec225.com

² Promat Inc.
(865) 681-0155
E-mail: sales@promat.us
www.promat.co.uk

³ James Hardie Building Products
231 S. LaSalle St., Suite 2000
Chicago, Illinois 60604
Toll Free: (888) 542-7343
www.jameshardie.com

⁴ U.S. Architectural Products, Inc.
1117 Douglas Avenue, Unit 1
North Providence, Rhode Island 02904
Toll Free: (800) 243-6677
www.architecturalproducts.com

ENCLOSING the FIREPLACE

THE ENCLOSURE

A safe installation of your Element4 fireplace requires that four things be clearly understood.

1. Most important, these fireplaces are NOT zero-clearance fireplaces. Unlike zero-clearance fireplaces, there is not a metal box around the Element4 fireplaces. With no metal box there are no louvers to distract your view of the fire. However, we want the cooling advantage of a metal box so your site-built, non-combustible enclosure will substitute.
2. Your fireplace enclosure must be made to *act* the way a metal fireplace box acts - letting room air in below and warm convection air out above. The framing cannot interfere with the air flow. The *inlet* for the room air is part of the fireplace and cannot be changed or adjusted. The convection air outlet is part of your enclosure design, is provided by you and **MUST** be included. *Note: The Convection Air Outlet must be installed in the same room as the fireplace and a space which ALWAYS flows air into the room in which the fireplace is installed. The flow of convection air must NOT be blocked.*
3. Since these are not zero-clearance fireplaces, the clearances and dimensions listed in the **CLEARANCES** section **MUST** be maintained. Only the non-combustible wall, the mounting brackets and the venting may touch the fireplace. As previously stated, *nothing* may be built closer than 2"/50 mm to the non-glass sides.
4. The controls will be mounted to your enclosure and below the burner. The controls are at the end of a 50"/1270 mm line set and are to be mounted to the Wall Access Door which is included. The controls must be located for ease of physical access (gas line, maintenance, etc.) as well as wireless signal (remote control) access. See the **LOCATING THE CONTROLS** and the **MOUNTING THE CONTROLS** sections.

The combination of multiple glass sides and no zero-clearance box makes for a non-typical enclosure project. It may seem straightforward to build the 'rough opening', set the fireplace then attach the wall. However, for most projects, it will be easier to first set the fireplace in position then enclose it with Skamol Skamotec® or Promat PROMATECT® building board.

ONLY non-combustible framing must be used to enclose these fireplaces.

In all cases, the framing/wall around these fireplaces must NOT be supported by the fireplace. The enclosing walls must be attached to another structure which can bear their entire weight and the weight of any attachments to the walls such as TVs, shelves, artwork, etc.

When installing the fireplace against an existing finished wall, the wall **MUST BE** completely covered with Skamotec 225 or Promatect building board. All clearances between the fireplace and wall **MUST BE** maintained.

CONVECTION AIR OPENING

A convection air outlet is always required. The opening size of the convection air outlet varies by fireplace model. Table 3, on page 17, shows the minimum total area required for the various models in this manual. The convection air outlet may take many forms and must always allow the free flow of warm air up through the chase and out into the room in which the fireplace is installed. Shown on the next page are a number of ways to design the convection air outlet into your project.

ENCLOSING the FIREPLACE

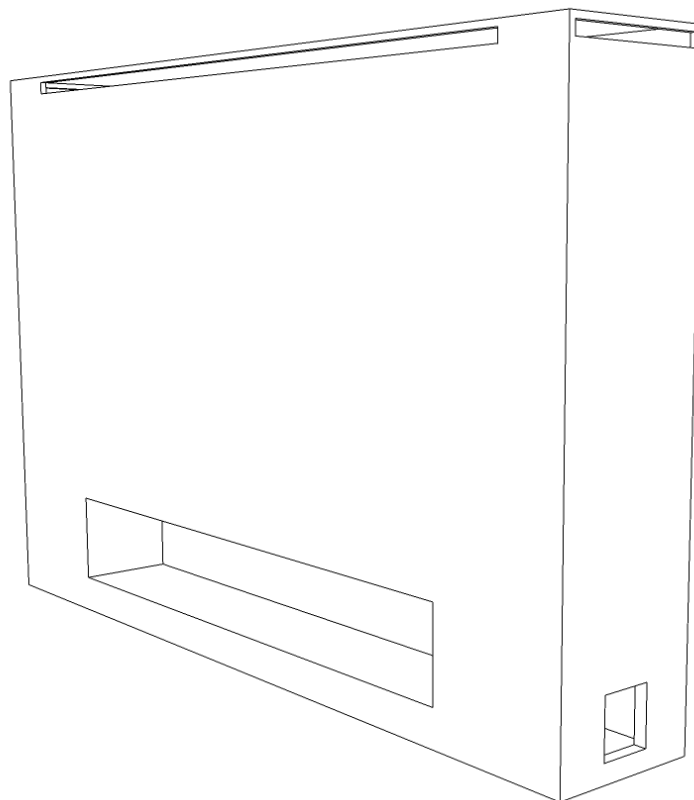

*Modore/Tenore 240
with Wall Outlets*

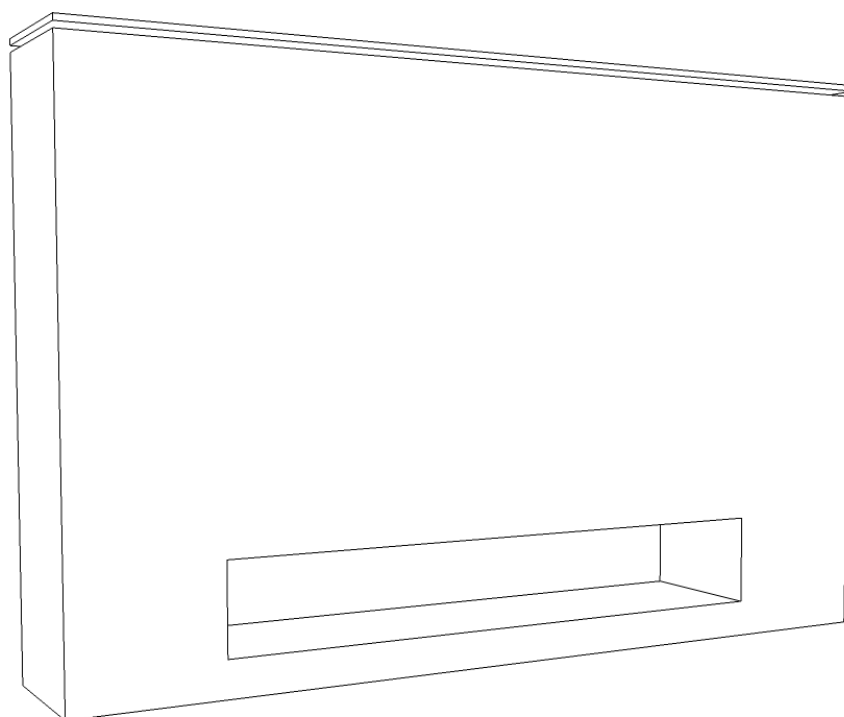

*Modore/Tenore 240
with Outlet in Reveal*

ENCLOSING the FIREPLACE



**DO NOT ALLOW THE FIREPLACE
TO BEAR ANY WEIGHT**



Dimension A and Dimension B (see below) must be equal throughout the installation.

Any support framing must be at least 2"/50 mm (NON-combustible framing ONLY) above and beside the fireplace. The entire weight of the non-combustible walls must be borne by a structure other than the fireplace.

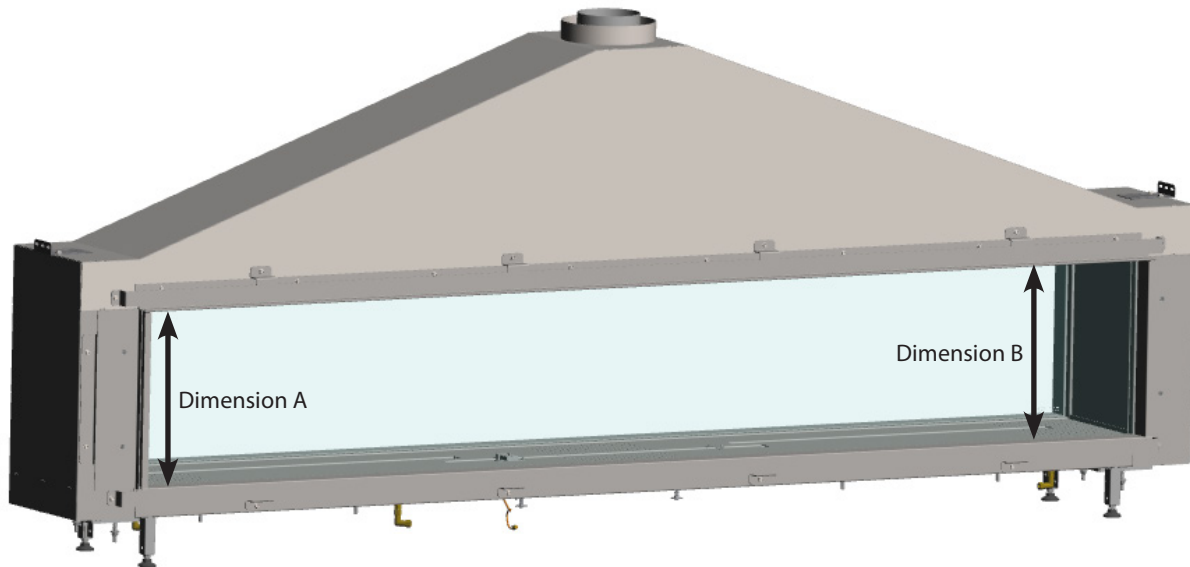

ENCLOSING the FIREPLACE

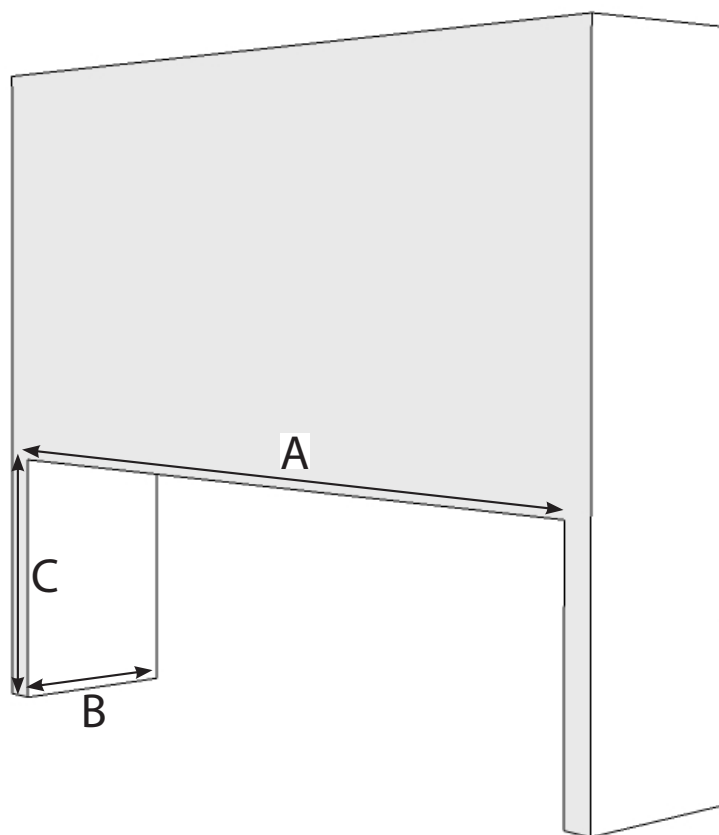

Rough Opening Dimensions for NON-COMBUSTIBLE Framing			
Model	A	B	C
Modore 240	109½"/2780 mm	17"/434 mm	41¼"/1048 mm
Tenore 240	109½"/2780 mm	15⅞"/384 mm	41¼"/1048 mm

ENCLOSING the FIREPLACE

COLD CLIMATE INSULATION

For cold climate installations, it is especially important to insulate outside the chase cavity, between studs and under the floor on which appliance rests, if floor is above ground level. Gas line holes and other openings should be filled with approved firestop.

If the fireplace is being installed on a cement slab in cold climates, a sheet of plywood or a raised platform can be placed underneath to prevent cold transferring to the fireplace and into the room. It also helps to tape the venting for maximum air tightness and to caulk firestops.

LOCATING THE CONTROLS

The control system for the Element4 fireplaces consist of three major components: the receiver, the transmitter and the gas valve. The transmitter is the remote control by which you operate the fireplace. The receiver and the gas control are at one end of a line set which will extend approximately 16"/406 mm to the *left* of the fireplace. The other end of the line set is connected to the firebox just left of center. As shipped, the line set is wrapped together and fixed beneath the fireplace.

The Wall Access Door is provided with your fireplace and is designed to hold the receiver and gas control. When locating the Wall Access Door you must consider four types of access:

1. *Air access.* Room air must be allowed to flow freely through the door perforations, up through the site-built platform and above, through the enclosing fireplace chase.
2. *Line set access.* The line set is to be unwrapped which allows the controls to be then placed within approximately 16"/406 mm from the left end of the fireplace, as the cable runs.
3. *Physical access.* The gas valve/receiver must be readily accessible for maintenance, etc.
4. *Wireless access.* The signals from the transmitter (handheld, remote control) must get to the receiver, inside the access door.

Note that if the Access Door is not used its equivalent in air (25 square inches) as well as line set, physical and wireless access must be provided.

MOUNTING THE CONTROLS

Do not place the controls above the level of the burner. If the fireplace is to set directly on the floor, the controls must be placed outside the non-combustible zone or insulated from the heat from the fireplace.

The Wall Access Door requires a rough opening of 9¹³/₁₆"/250 mm high by 6¹⁵/₁₆"/175 mm wide. The door should be mounted with the hinge on the left side or with the hinge side down.

- Carefully cut the black tie wraps which hold the line set to the bottom of the fireplace then carefully unwrap the line set. Lay the line set out towards the location of the Access Door. Do not kink the lineset and do not bend to a radius of less than 2"/50 mm. See Figure 23.
- Remove the four bolts holding the white door/frame cover to the frame. Separate the frame and cover then mount the Access Door frame to the rough opening as shown in Figure 24.
- Replace the white door/frame cover onto the frame and secure it with the four bolts.
- Fit the gas control tab into the bracket on the Access Door frame then tighten the bolt through the mounting bosses . See Figures 25 and 26.
- Set the receiver into the Access Door bracket as shown in Figure 27 and connect the AC adapter.

When mounted, the Access Door should look like that shown in Figure 28.

ENCLOSING the FIREPLACE

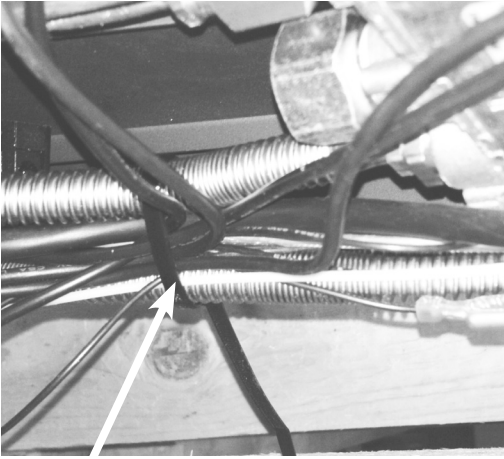

One of the tie wraps which secure the line set.
Figure 23

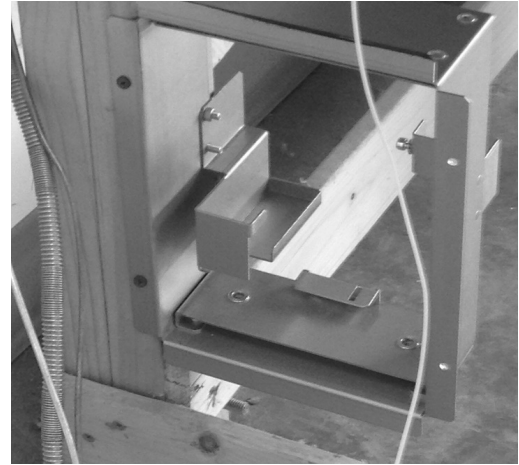
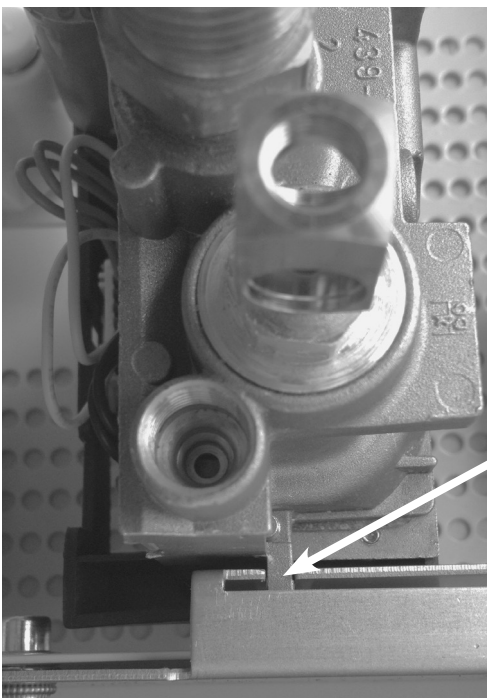
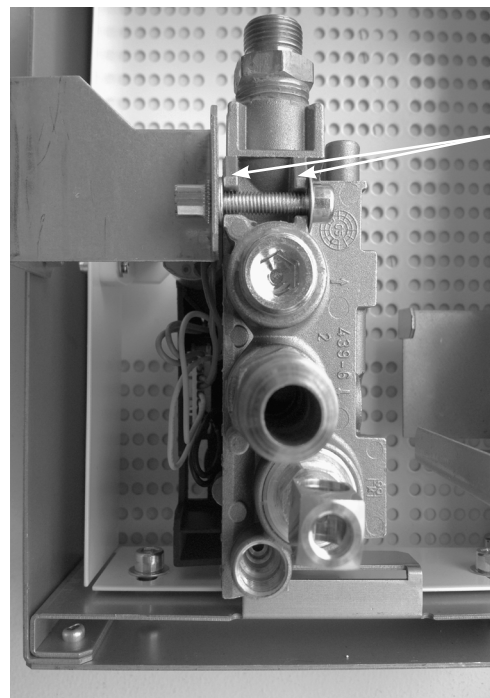

Figure 24 Wall Access Door Frame



Fit tab into bracket
on Access Door

Figure 25



Tighten bolt
through
mounting bosses
(at arrows)

Figure 26

ENCLOSING the FIREPLACE



Figure 27 Receiver in Wall Access Door

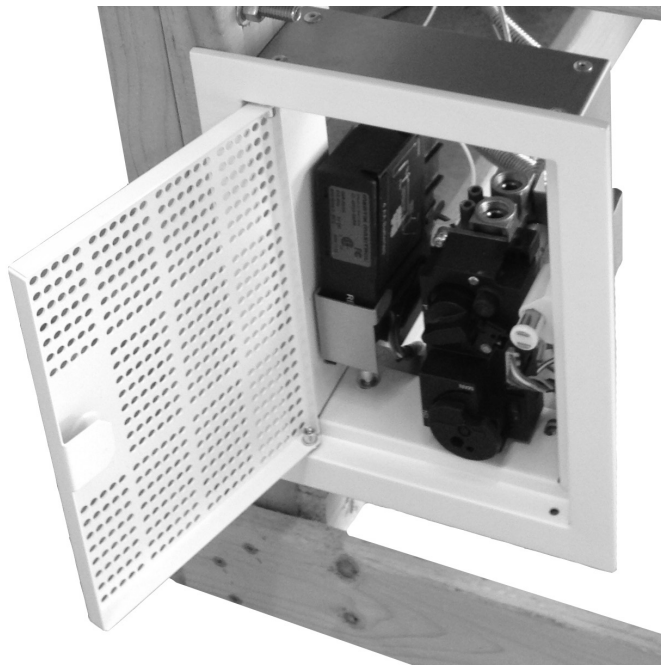

Figure 28 Access Door Installed

OPERATING the FIREPLACE

BEFORE THE FIRST FIRE

1. Make certain that all construction materials have been removed from inside and around the fireplace and the fireplace has been cleaned of any construction dust.
2. Confirm that the gas valve is properly connected and bled.
3. Check the gas supply for leaks and proper pressure.
4. Check that the venting is unobstructed and in proper working condition.
- 5. PROPERLY PLACE, CLAMP, AND SEAL THE GLASS PANELS.**
6. Place the three AAA batteries into the remote control and confirm that it will communicate with the receiver by pressing the **ON/OFF**. (See Figure 30) If necessary pair the remote and receiver.
7. Follow **USING THE REMOTE CONTROL ELECTRONIC IGNITION SEQUENCE** to setup and use remote.

THIS PART WAS INTENTIONALLY LEFT
BLANK

OPERATING the FIREPLACE

PAIRING THE REMOTE AND RECEIVER (for first fire and when reset is needed)

From the factory, the remote control will communicate with the receiver; they are 'paired' and should need no further attention. If the receiver does not respond to commands from the remote they should be paired to each other. This is done as follows:

1. Press and hold the receiver reset button (Figure 29) using a small, long tool until you hear the second of two beeps. After the second beep release the reset button.
2. Press and hold the ↓ (down) button on the remote until you hear the second of two beeps. Release the ↓ (down) button.



Figure 29 Receiver

USING THE REMOTE CONTROL ELECTRONIC IGNITION SYSTEM

Note: The system shuts off the appliance completely if there is no change in the flame height for 5 days.

Setting °C/24 Hour or °F/12 Hour Clock.

Press **ON/OFF** and ↓ to toggle between °F/12 hr and °C/24 hr clock.

Setting the time.

Simultaneously press the ↓ and ↑ buttons, the display will flash.

Press ↑ to set the hour and ↓ to set the minute.

Press **ON/OFF** to return to manual mode.

HOW TO LIGHT YOUR FIREPLACE

Igniting the Appliance.

NOTE: During start-up, the *MANUAL* knob on the gas valve cannot be in the *MAN* position. It must be in the *ON* position. See Figure 31.

On the remote control, simultaneously press and hold the **ON/OFF** and ↑ buttons.

An acoustic signal indicates that the start sequence has begun. Release the buttons.

The electronic system then checks that the main gas is flowing and ignites the main burner; this may take up to 20 seconds.

Changing the Mode of Operation.

Briefly pressing the **SET** button changes the mode of operation in the following order:

Man - *Temp - ⤵Temp - Timer - back to **Man**

*Man - Manual Flame Height Adjustment.

To increase the flame, the ↑ button should be depressed. Pressing the ↓ button on the handset will reduce the flame. The main flame may be lowered all the way down until it is off, leaving only the pilot ignited. This is called standby mode.

Fully Extinguishing the Appliance

From any heat setting, press the **ON/OFF** button for a few seconds. This will cause the burner to fully extinguish.

The system has a safety interlock which will not allow the ignition until the interlock rests. This may take a few minutes.

The appliance should be shut off completely using the **ON/OFF** button on the handset and not left on pilot only, except for temporary use. This resets the system and all safety features.

*Temp - Daytime Temperature mode.

The appliance must be in standby mode, pilot ignited. The room temperature is measured and compared to the set temperature.

The flame height is then automatically adjusted to reach the daytime set temperature.

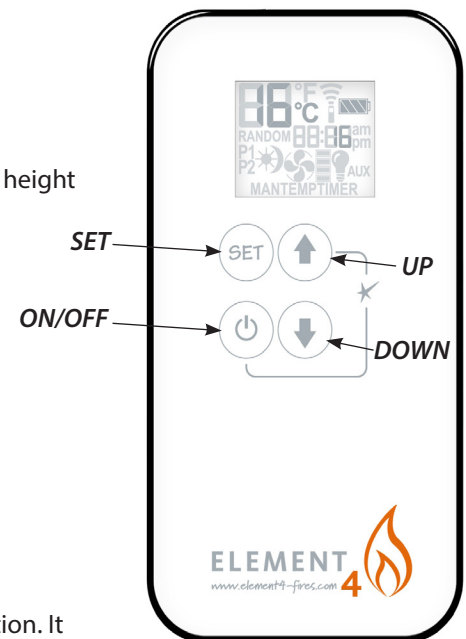

Figure 30 Remote Control

OPERATING the FIREPLACE

⤵Temp - Nighttime setback Temperature mode.

The appliance must be in standby mode, pilot ignited. The room temperature is measured and compared to the nighttime setback temperature. The flame height is then automatically adjusted to achieve the nighttime setback temperature.

Timer mode.

The appliance must be in standby mode, pilot ignited. The Timer setting allows you to set 2 burner **★Temp** times and 2 burner **⤵Temp** times every 24 hrs.

For **⤵Temp** to operate as a thermostat, TEMP must be set at 4°C or higher.

If the **⤵Temp** setting is decreased to --, the motor will turn the valve to the standby position in the moon times and await the next burner **★Temp** cycle.

Setting the Temperature.

Select either the **★Temp** MODE or the **⤵Temp** MODE by briefly pressing the **SET** button.

Hold the **SET** button until the TEMP display flashes.

Set the desired temperature with **↓** or **↑**.

Press **OFF** to complete the program.

Setting the Timer.

Select Timer mode by briefly pressing the **SET** button.

Press and hold the **SET** button until the P1**★** is displayed, and the time flashes. Set the hour by pressing **↑** and set the minutes by pressing **↓**.

Briefly press **SET** button for the next burner cycle time.

Once all 4 times are set, press **OFF** to complete the programming.



Figure 31 Gas Valve

Automatic Turndown.

1. In Manual/Temperature/Timer modes, the valve will turn to pilot flame if there is no change in flame height for a six hour period. In Temperature or Timer mode, if the ambient room temperature changes, the flame height will adjust automatically to maintain set temperature and the fire will continue to function normally. The valve will turn to pilot flame if the set temperature and the ambient room temperature remain the same over a six hour period.

2. The valve turns to pilot flame if the temperature in the receiver is higher than 140°F/60°C. The main burner comes back on only when the temperature is below 140°F/60°C.

Automatic Shut Off.

1. With low battery power in the receiver, the system shuts off the fire completely. This does not happen if the power supply is interrupted.

2. The system shuts off the fire completely if there is no change in flame height for 5 days.

3. The system shuts off the fire if the main burner does not completely ignite approximately 20 seconds after ignition or after pushing the **↑** button.

OPERATING the FIREPLACE

TEST FIRE

Prior to being placed into operation, the fireplace should be test-fired in stages to ensure that all components are in good working order. This fireplace has a 2nd thermocouple which senses the main burner flame. The system will turn itself off if the system does not sense the 2nd thermocouple output within 20 seconds after the main valve opens.

Note that a single, long beep indicates that the 2nd thermocouple is still hot enough to produce electricity at the receiver which will not allow the fireplace to start. Allow time for the 2nd thermocouple to cool down before attempting a start. The system is ready to start when pressing the ON/OFF button produces a response from the valve.

1. Start the fireplace without the hearth panel in place and with the front glass off. Ensure that the pilot flame both heats the primary thermocouple and lights the main burner. For safety, a post-purge delay is built into the system. Subsequent start attempts **MUST NOT** take place for at least five (5) minutes.
2. Start the fireplace with the hearth panel in place and with all of the glass panels fixed correctly in place. Ensure that the main burner flames engulf the 2nd thermocouple and the fireplace stays lit for at least 1 full minute. If the system turns itself off after 20 seconds install the required media (next section) and return here. Installing the fire media will help with the flame around the 2nd thermocouple. Subsequent start attempts **MUST NOT** take place for at least five (5) minutes.
3. Start the fireplace with the media installed. If the system turns itself off after 20 seconds, rearrange the media to produce a good flame at the 2nd thermocouple. This step may have to be repeated several times before the media is in the best place for consistent operation. A single, long beep indicates that the 2nd thermocouple is still too hot to start the ignition sequence. Allow time for the 2nd thermocouple to cool down. Once the system stays lit for at least one full minute, turn the fireplace off, fix the glass panels in place and operate the fireplace for at least 45 minutes to ensure the system works properly when heated.

THE FIRST FIRE

When the fireplace is first heated, an odor may be given off by the hot metal. This is normal and is a result of the 'burn off' of the lubricants and sealants used when manufacturing the fireplace. We recommend that you open the nearby windows for extra ventilation and then operate the fireplace for at least four hours.

When the glass is cold, some condensation may appear on the glass after lighting the fireplace. This is normal and the condensation will disappear as the glass warms.

During this first fire, examine the flame for appearance and quality. Examine the burner media for sooting. The flames should look like those shown in Figure 32.

After this burn-off period, turn off the fireplace and let it cool completely to room temperature and clean both sides of the glass and the interior panels as described in the **MAINTENANCE** section.

Since it is a metal fireplace, the heat-up and cool-down cycles may produce some noises caused by the expansion and contraction of these metals. The premium materials and build quality of your fireplace will keep these sounds to a minimum.

Figure 32



To see an Element4 fireplace starting and running normally please visit the link below.

WWW.EUROPEANHOME.COM/RESOURCES/VIDEOS/



INSTALLING THE FIRE MEDIA

INSTALLING THE HEARTH PANELS (ALL MODELS)

The fireplace has an eight piece hearth panel set which is assembled in the order shown below. Note that panel number 1 is screwed in place, all other panels are packaged separately.

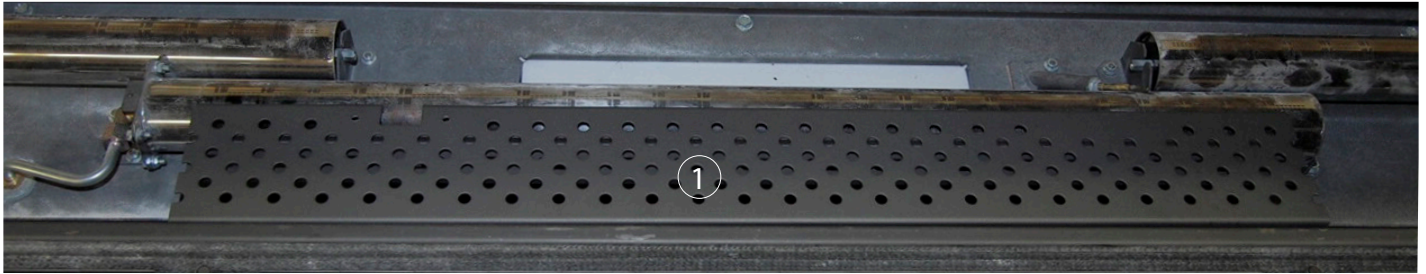

Figure 33 Center

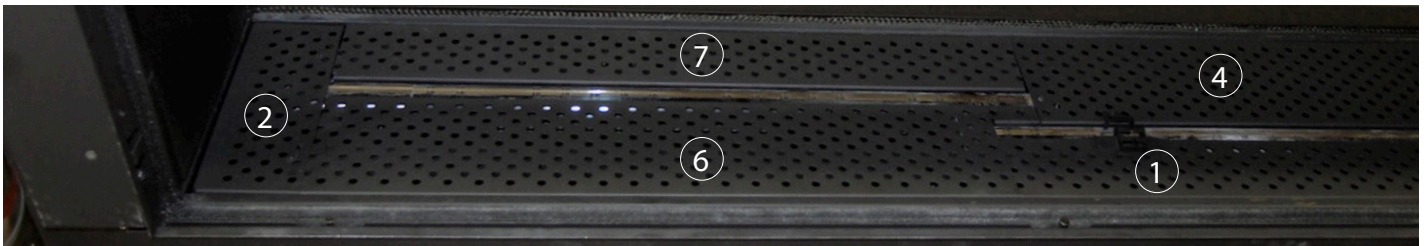

Figure 34 Left Side

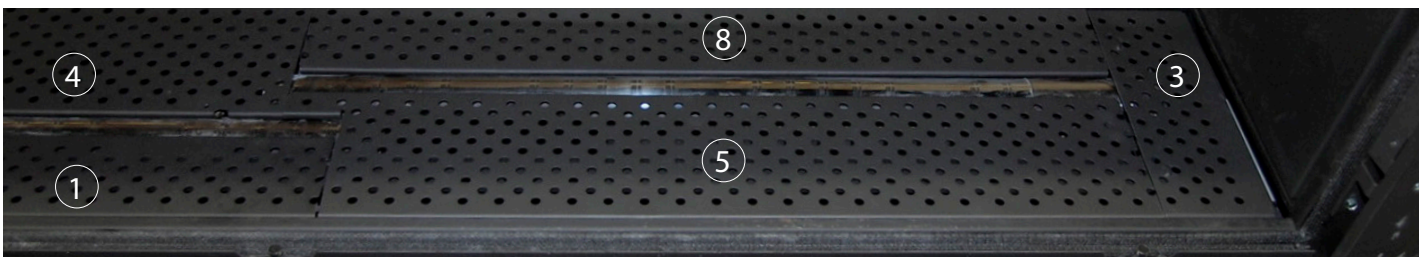

Figure 35 Right Side

INSTALLING THE FIRE MEDIA

LOG ARRANGEMENTS

Ensure that the hearth panel is sitting firmly in the base of the fire box with the long slot in the center of the panel aligning with the top of the burner. The pilot flame must be visible through the panel and the cut-out in the pilot shield. Place the six coals and two cones as shown in Figures 36 - 40. Ensure that the area around the pilot and second thermocouple remains clear.

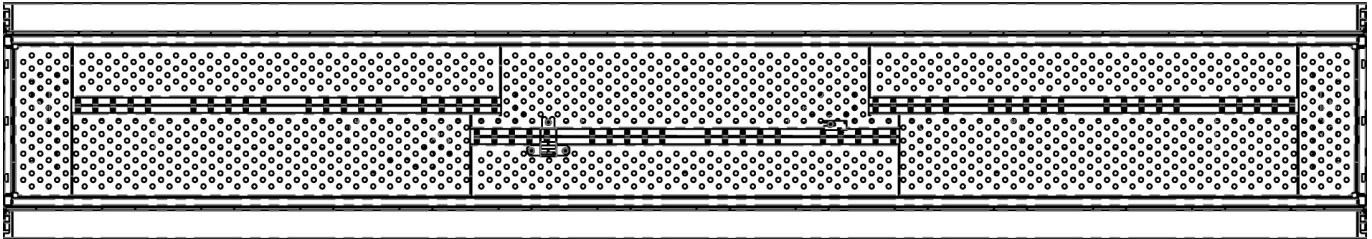

Figure 36

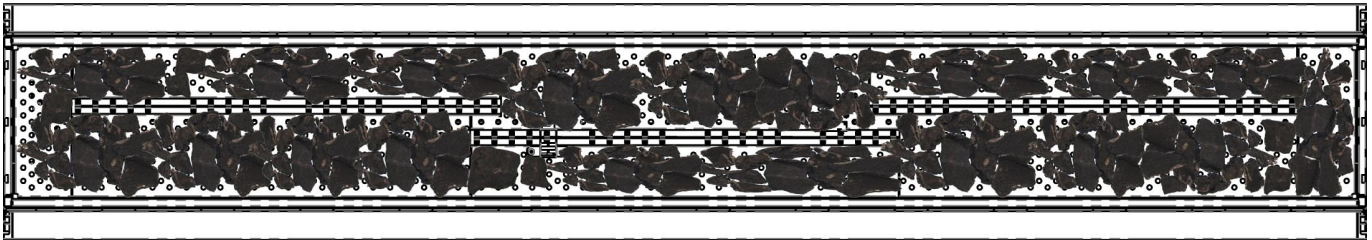

Figure 37

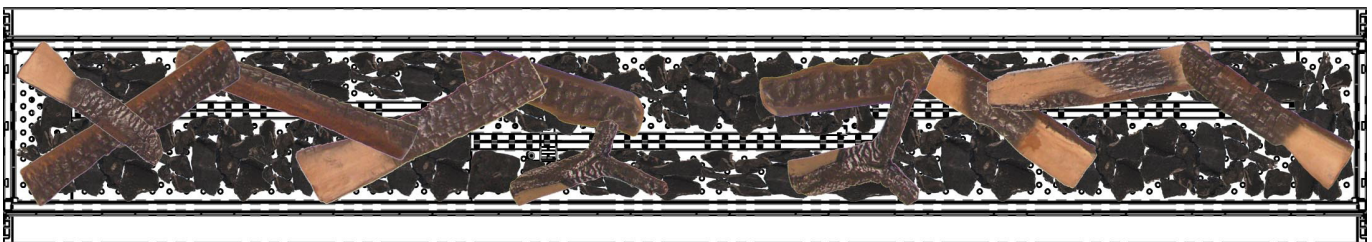

Figure 38



The bag of ash (shown on the left) comes with your logset. Its purpose is to make the logs look more realistic. The use of this ash is optional.

To use:

- Sprinkle the ash onto the logs as desired.
- Make sure that the ash **DOES NOT** get inside of the burner ports. If so, clogging may occur.

INSTALLING THE FIRE MEDIA



Figure 39



Figure 40

INSTALLING THE FIRE MEDIA

STONES/GLASS ARRANGEMENTS

Ensure that the hearth panel is sitting firmly on the base of the fire box and the shield is installed around the 2nd thermocouple. The center panel must be inserted in between the burner tubes. The pilot flame must be visible through the hearth panel and the pilot shield.

Evenly scatter the contents of the bag of stones/glass over the top of the hearth panel and burner. Ensure that none of the stones/glass enters the pilot area or restricts the operation of the 2nd thermocouple.

The arrangement is now complete. However, it is important to check that the pilot flame is still visible.

A shows the arrangement for stones; the arrangement for glass is similar.



B shows the pilot area (arrow) clear of media.

C shows the 2nd thermocouple area (arrow) clear of media.



To see how to arrange media in an Element4 fireplace please visit the link below.

WWW.EUROPEANHOME.COM/RESOURCES/VIDEOS/



SCREEN INSTALLATION

MODORE 240		TENORE 240	
Tabs	4	Tabs	8
Magnets	12	Magnets	24
Long Screen	1	Long Screen	2

Figure 41

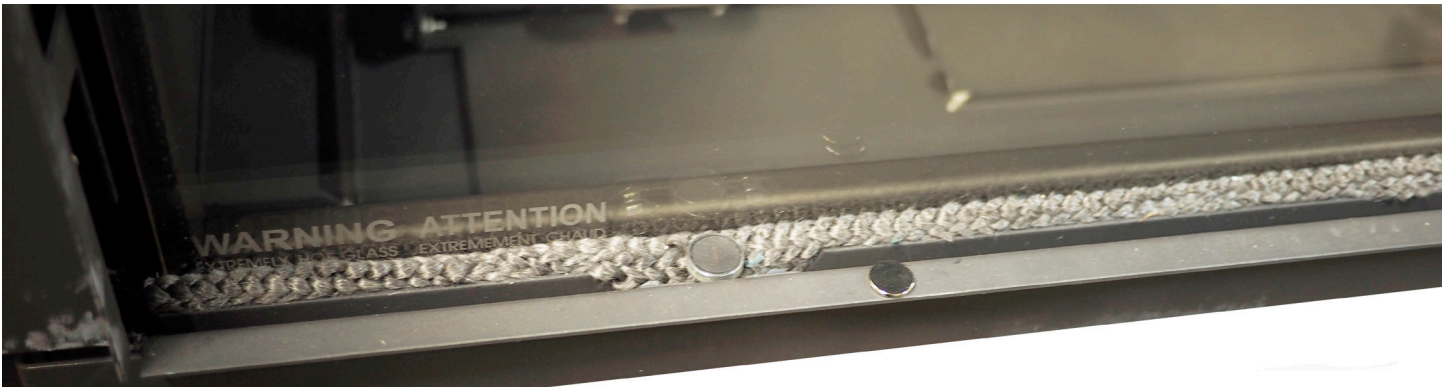

Figure 42 Place a single magnet on the bottom return flange 12" from the lower left corner, lower right corner, and the center.

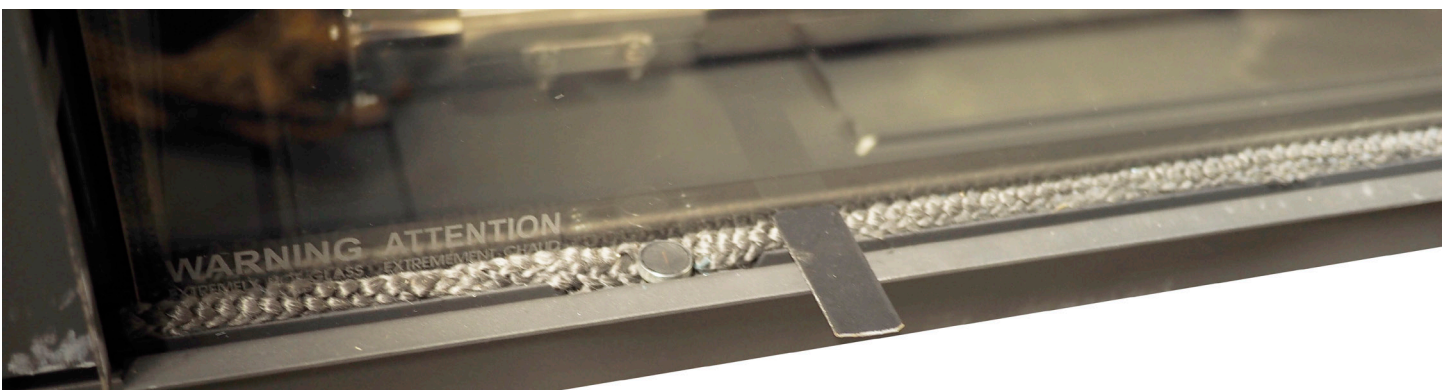

Figure 43 Place flat metal tab on magnet and push against glass on both left and right sides (not center).

SCREEN INSTALLATION

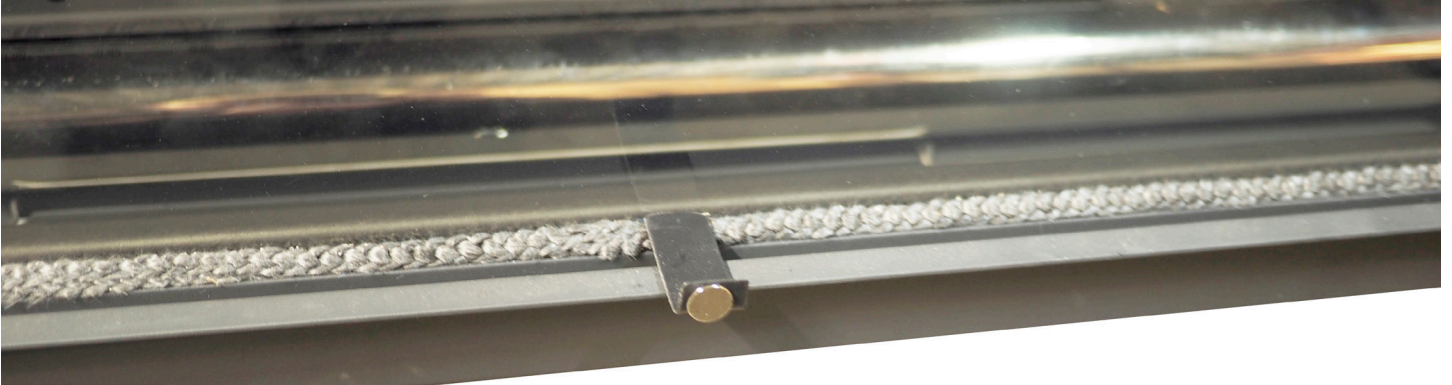

Figure 44 Place "L" shaped metal tab on center magnet with the short end facing up and out. Place magnet on short end face.

Using the "S" shaped metal tab, place a magnet on both face ends. Position metal tab at the top center of the fireplace. Slide tab up to the top of the trim so that one end of the tab sticks to the fireplace cabinet, not the outer frame (see below).

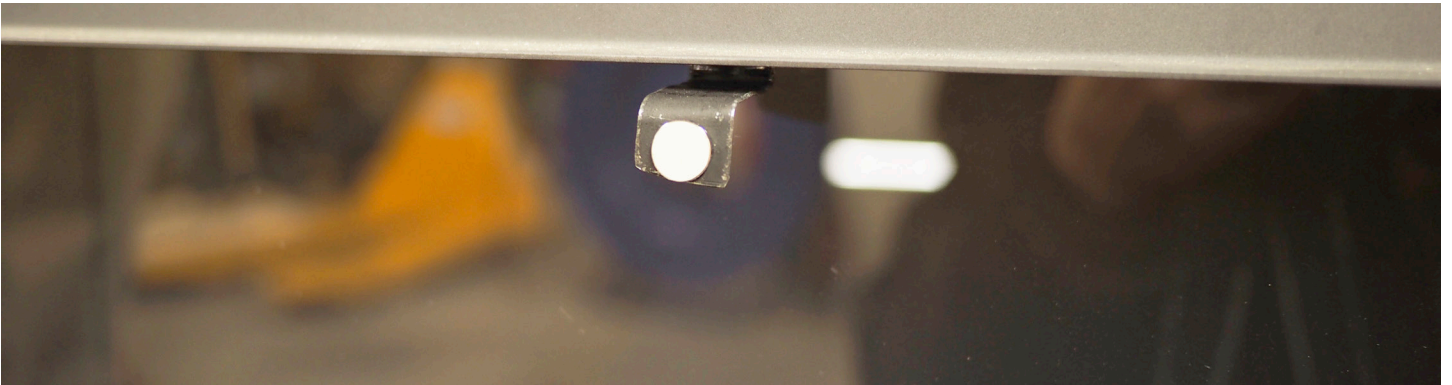

Figure 45 *Straight View*
(Straight view of top, center, tab.)

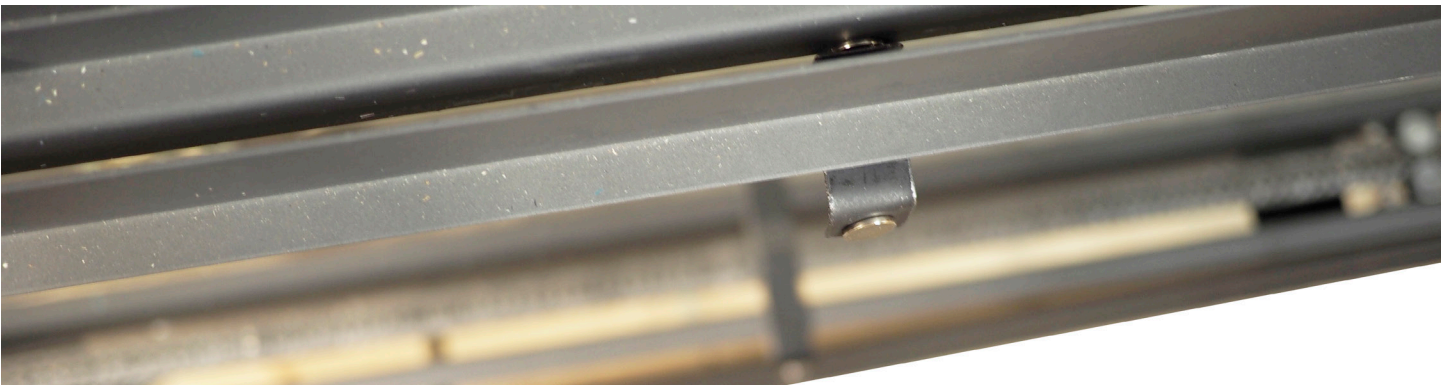

Figure 46 *Overhead View*
(Overhead view of top, center, tab.)

SCREEN INSTALLATION

When the bottom trim put into place the 3 metal tabs will be exposed (see below).

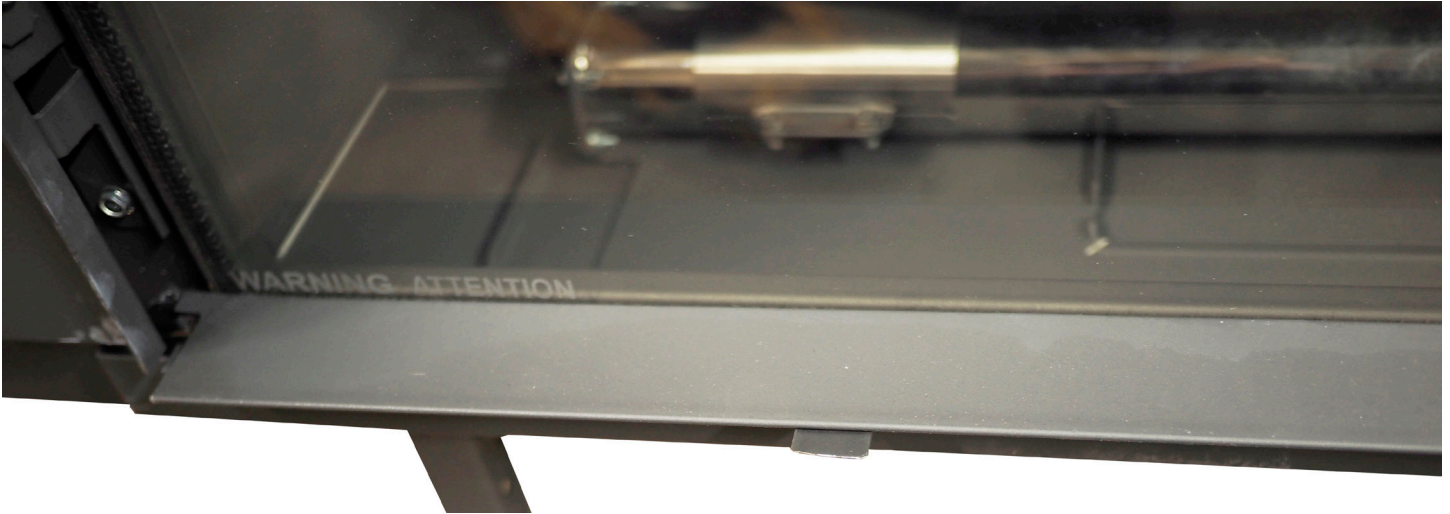

Figure 47

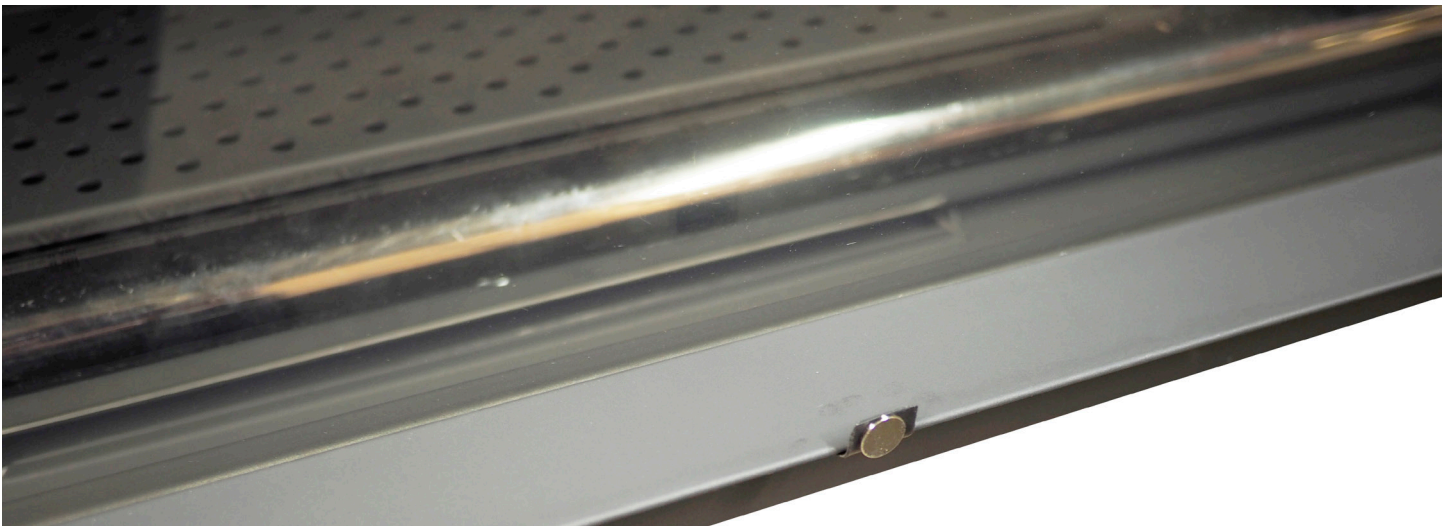

Figure 48

SCREEN INSTALLATION

Place 3 magnets on both left and right trims (top, center, bottom) and attach trims to fireplace.



Figure 49 Without side trim



Figure 50 With side trim plus magnets



Figure 51 Rest the bottom of the screen on the 3 tabs that are under the trim. Push the screen into position so that the exposed magnets come in contact with the screen frame.

SCREEN INSTALLATION

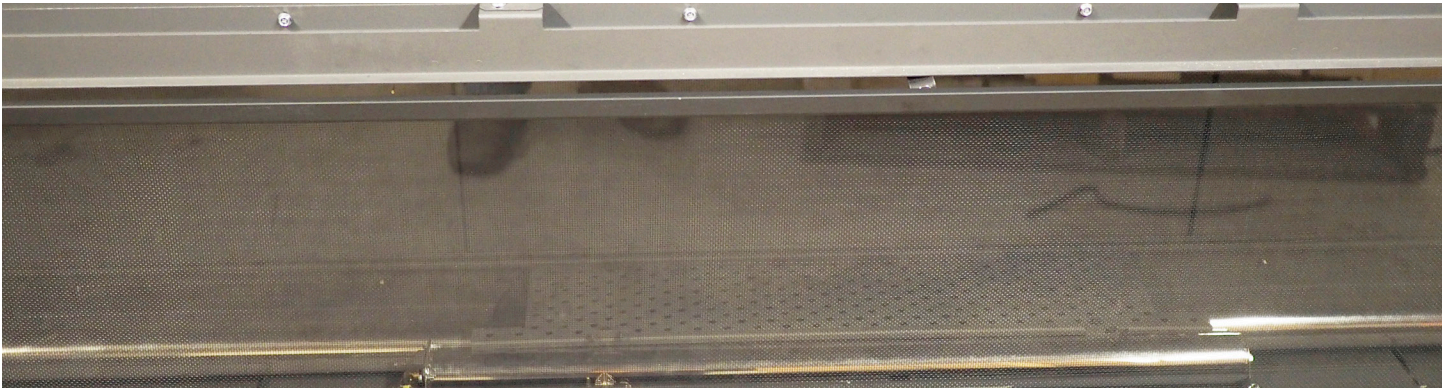

Figure 52 *Screen in Position*

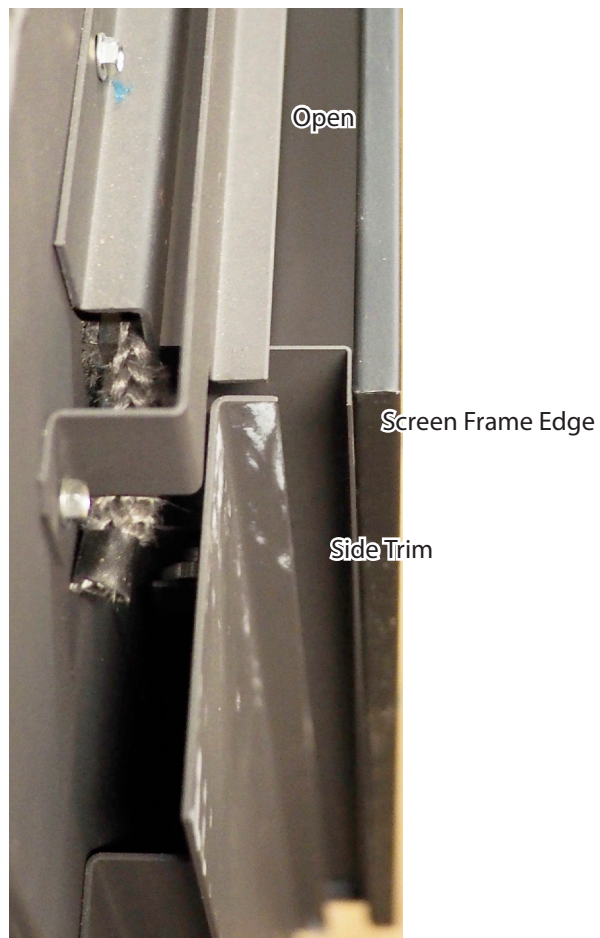

Figure 53 *Top View with Screen Attached*

MAINTENANCE

REMOVING AND CLEANING THE GLASS

OVERVIEW

The glass panel(s) are held in place by two gasketed clamps (one on either side with two bolts each) and a rope gasket at the lower edge of the glass. These instructions require two technicians and will show you how to remove and install the glass panel(s).

Please read these instructions completely before proceeding.

TOOLS REQUIRED

- No. 2 Phillips screwdriver (not included)
- Gloves (not included)
- 2 Suction Cups

REMOVING THE GLASS

Step 1.

Remove all of the trim pieces (magnetically attached) from the fireplace. (See Figure 54) The Tenore has two glass panels, therefore, twice the number of trim pieces. There is no top trim on either fireplace. The trim pieces are held firmly in place with magnets and will simply lift out. The bottom (horizontal) trim pieces are at the lower edge of the glass panels and the side (vertical pieces) are where the glass meets the wall.

Step 2.

The glass panel is held in place by a gasketed glass clamp on the left and right ends and a rope gasket along the bottom edge. Remove the retaining bolt(s) holding the glass clamps and then remove the clamps. (See Figure 55) Gently pull the rope gasket from its channel.

Step 3.

Securely attach a vacuum glass clamp to the glass approximately 24"/600 mm from either end and lift the glass up into the clearance notch.

With the glass panel raised into the upper rail, swing the lower edge of the glass panel out towards the room and gently lower the glass towards the floor until it clears the fireplace.

Step 4.

Repeat Steps 2 and 3 for the other glass panel, if present.

PROPERLY PLACE, CLAMP AND SEAL THE GLASS PANEL(S) BEFORE LIGHTING THE FIRE!

To see how to remove the glass from an Element4 fireplace please visit the link below.

WWW.EUROPEANHOME.COM/RESOURCES/VIDEOS/

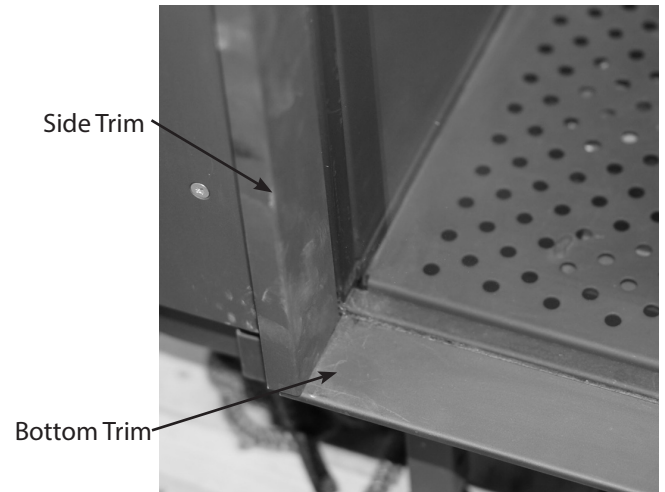

Figure 54



Figure 55

MAINTENANCE

CLEANING THE GLASS

Burning natural gas (NG) or propane (LP) in this fireplace will always result in some of the gas components being deposited on the glass. Hydrogen sulfides and mercaptans, which are present in the burning gas, condense onto the relatively cooler glass surface and cause white film to build up over time.

The amount of this white film is influenced by a number of factors such as; the configuration of the system venting, thermal efficiency of the fireplace design, the humidity of combustion air, frequency of fireplace use, burner performance and, the fireplace design itself.

Do not use normal household (usually ammonia-based) glass cleaners to clean the glass as these cleaners can leave a permanent stain. Only a gas fireplace glass cleaner should be used. Products such as Stove Bright® Gas Appliance Glass Cleaner by Forrest Technical Coatings, Imperial Gas Fireplace Glass Cleaner by Imperial Manufacturing Group and GFC™ Gas Fireplace Glass Cleaner by A.W. Perkins Co. are designed for this purpose.

Follow the instructions for use and **do not clean the glass when it is hot!** If the glass becomes coated with deposits which cannot be removed it must be replaced.

The fireplace glass should be cleaned before the fireplace is first lit and then after the fireplace has been through its four hour burn-in cycle. This will reduce potential build up on your glass.

MAINTENANCE

INSTALLING THE GLASS

The glass panel(s) should be installed in reverse order of their removal.

Step 1.

Securely attach the two vacuum glass clamps, each approximately 24"/600 mm from either end. Lift the glass panel up into the upper rail and swing the lower edge of the glass panel against the firebox gasket. Set the glass clamps into place and hold them loosely into place with a retaining bolt. DO NOT tighten the retaining bolts yet.

Step 2.

Ensure that the glass is flat against the firebox gasket and centered on the firebox.

Step 3.

Center the rope gasket on top of the gasket channel (in front of the lower edge of the glass.) While holding the center in place, gently stretch the gasket while laying it into the gasket channel, left and right. Press the gasket down into the length of the gasket channel. (See Figure 57)

Step 4.

Hand tighten the bolts onto the glass clamps. Tighten the bolts ¼ turn further.

Step 5.

While ensuring that the glass panels are tight and square to each other, tighten the retaining bolt(s) on each clamp NO MORE THAN ¼ TURN.

PROPERLY PLACE, CLAMP AND SEAL THE GLASS PANEL(S) BEFORE LIGHTING THE FIRE!

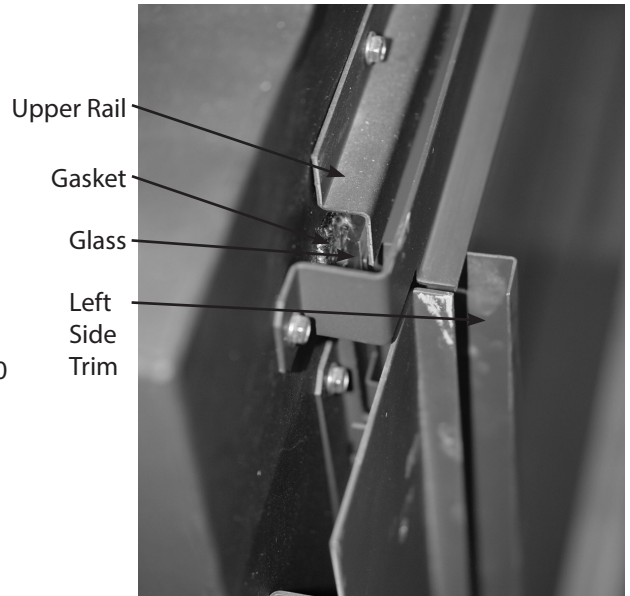

Figure 56

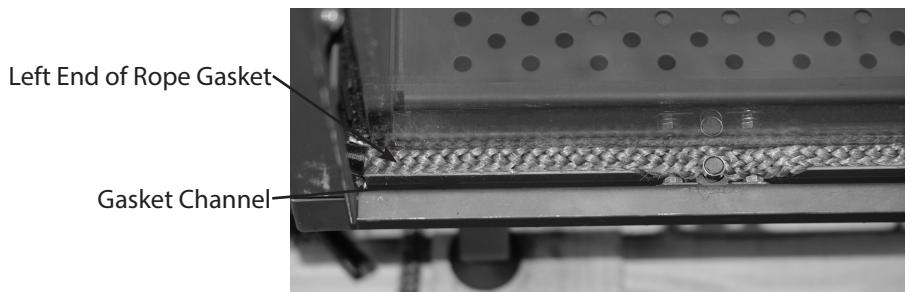

Figure 57

MAINTENANCE

BURNER MAINTENANCE

The flames from the burner should be visually checked. The flame should have a blue base and yellow tops and be candle-like in appearance.

PILOT MAINTENANCE

The pilot flame must be visually checked. The pilot flame must always be present when the appliance is in operation and should appear as in Figure 59 (shown with hearth panel removed.)

The pilot has two distinct flames, one engulfing the thermocouple on its left, the other reaching across to the main burner.

The area around the pilot should be inspected. Lint or foreign material must be removed with a brush or vacuum.

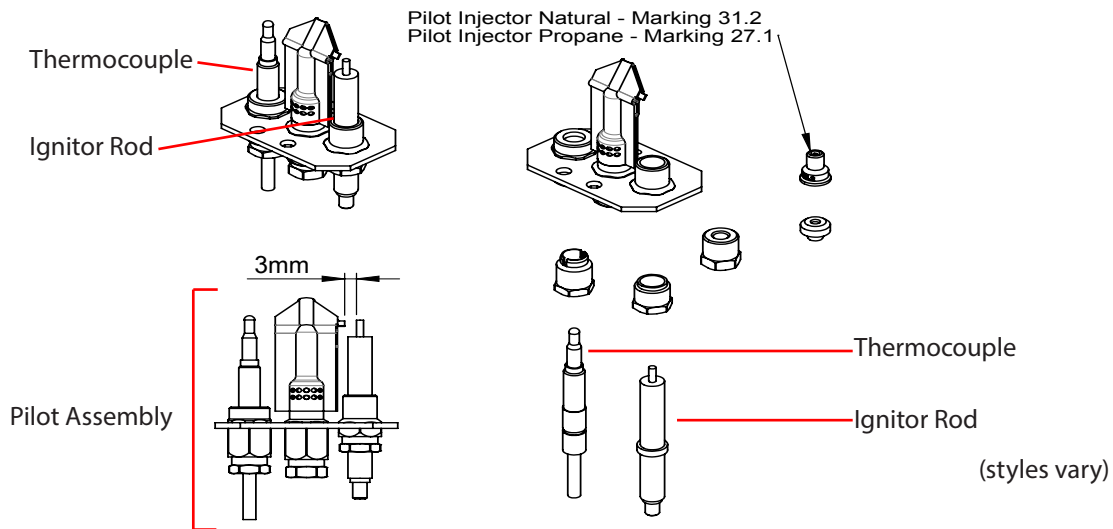

Figure 58 Pilot Assembly Detail

WARNING

Installation and maintenance must be performed by an authorized qualified installer, service agency or gas supplier.

TURN OFF THE GAS before servicing the appliance. It is recommended that a qualified service technician perform an appliance check-up/service once a year.

Any safety screen or guard removed for servicing MUST BE REPLACED before operating this appliance.

DO NOT USE this appliance if any part has been under water. Immediately call a qualified service technician to inspect the unit and to replace any part of the control system and any gas valve that has been under water.

Any alteration to the product that causes soot or carbon to form and results in damage is not the responsibility of the manufacturer.

Inspect the external vent cap on a regular basis to make sure that no debris, plants, trees, or shrubs are interfering with the air flow.

MAINTENANCE

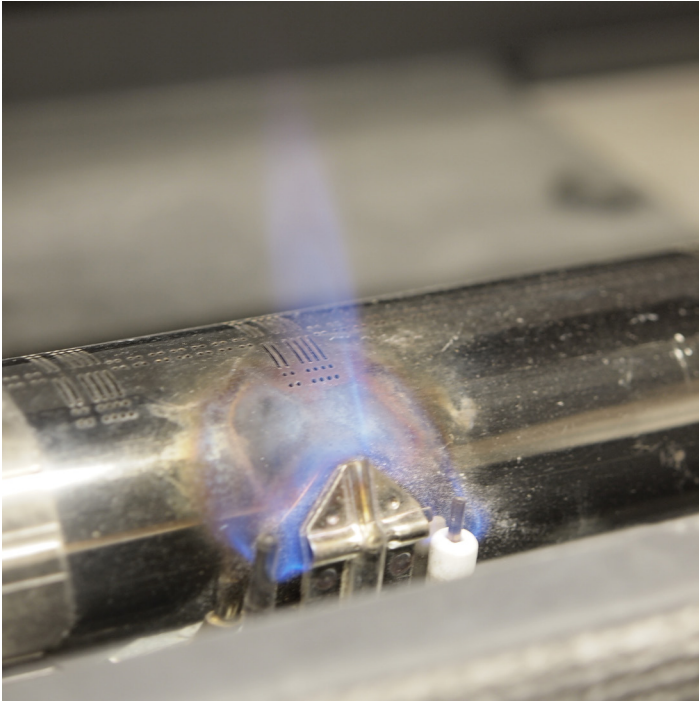

Figure 59

THERMOCOUPLE MAINTENANCE

The Element4 fireplaces have two thermocouples; one next to the pilot and one opposite the pilot side of the main burner. The completeness and operation of both must be checked. A qualified installer must confirm that both thermocouples are in place and not damaged. While checking the thermocouple, please ensure that the ignitor rod is not cracked as well.

VENT MAINTENANCE

The following venting system inspection by a qualified service technician is recommended every six months:

1. Inspect for excessive condensation, e.g. water droplets forming in the inner lining and subsequently dripping out of the joints. This can cause corrosion in the system.
2. Check for corrosion in areas exposed to the elements. Where rust spots or holes have appeared, these must be immediately replaced.
3. Ensure that there is no foreign material in the vents. Survey by removing the cap and shining a light down the vent.
4. Check all joints and pipes to make sure that nothing has been disturbed or loosened.

REPLACEMENT PARTS

The orifice for the burners is shown in Figure 60. The **NG** orifices are marked 650, **LP** orifices are marked 220.

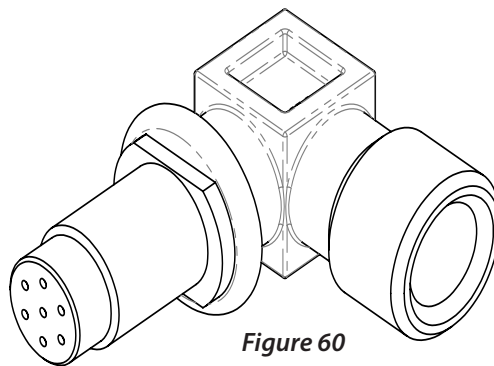

Figure 60

E4-SA-LPCK-240-04
REPL-E4-GS-1T-01
REPL-E4-GS-2T95-02
REPL-E4-GS-CM-01
REPL-E4-GS-PABT-01
REPL-E4-GS-RC-01

LP Conversion Kit
Primary Thermocouple
2nd Thermocouple
Receiver
Pilot Assembly
Remote Control

WARRANTY

European Home Warranty Element4 Gas Fireplace

European Home warrants these gas fireplaces against defects in materials and workmanship for a period of ONE (1) YEAR from the date of original retail purchase. Glass is expressly NOT covered by this warranty.

If a defect exists, European Home will, at its option, either (1) provide needed components using new or refurbished replacement parts or (2) exchange the product with one which is new or which has been manufactured from new or serviceable used parts and is at least functionally equivalent to the original product. A replacement product/part assumes the remaining warranty of the original product or ninety (90) days from the date of replacement or repair, whichever provides longer coverage for you. When a product or part is exchanged, any replacement item becomes your property and the replaced item becomes the property of European Home. All warranty claims must be submitted through the dealer from which you purchased the product. Check with your dealer in advance for any costs to you when arranging a warranty call. Shipping and/or delivery charges for parts are not covered by this warranty.

Nothing in the above shall be deemed to imply that this warranty shall apply to work which has been abused or neglected or shows evidence of changes or modifications by others with or without permit, damages caused by the acts of God, building settlement or moving, fire or vandalism. In addition, installation of this product that varies from the requirements stated in the instruction manual will void the warranty.

PRODUCT INSTALLATION RECORD

Installer: Please complete this form.

Customer: Please retain this information.

Model (check one)	MODORE 240 <input type="radio"/>	TENORE 240 <input type="radio"/>
Purchased From		
Date of Purchase		
Installed By		
Date of Installation		
Fireplace Serial Number		
Fuel Type		
Total Venting Horizontal		
Total Venting Vertical		

APPENDIX ONE

MASSACHUSETTS CERTIFICATION

This appliance is approved for installation in the Commonwealth of Massachusetts. The Board of State Examiners of Plumbers and Gas Fitters has issued approval number G1-0515-495 for this appliance.

The following must be observed when installing the Element4 fireplaces within the Commonwealth of Massachusetts:

(a) For all side wall horizontally vented gas fueled equipment installed in every dwelling, building or structure used in whole or in part for residential purposes, including those owned or operated by the Commonwealth and where the side wall exhaust vent termination is less than seven (7) feet above finished grade in the area of the venting, including but not limited to decks and porches, the following requirements shall be satisfied:

1. **INSTALLATION OF CARBON MONOXIDE DETECTORS.** At the time of installation of the side wall horizontal vented gas fueled equipment, the installing plumber or gasfitter shall observe that a hard wired carbon monoxide detector with an alarm and battery back-up is installed on the floor level where the gas equipment is to be installed. In addition, the installing plumber or gasfitter shall observe that a battery operated or hard wired carbon monoxide detector with an alarm is installed on each additional level of the dwelling, building or structure served by the side wall horizontal vented gas fueled equipment. It shall be the responsibility of the property owner to secure the services of qualified licensed professionals for the installation of hard wired carbon monoxide detectors

a. In the event that the side wall horizontally vented gas fueled equipment is installed in a crawl space or an attic, the hard wired carbon monoxide detector with alarm and battery back-up may be installed on the next adjacent floor level.

b. In the event that the requirements of this subdivision can not be met at the time of completion of installation, the owner shall have a period of thirty (30) days to comply with the above requirements; provided, however, that during said thirty (30) day period, a battery operated carbon monoxide detector with an alarm shall be installed.

2. **APPROVED CARBON MONOXIDE DETECTORS.** Each carbon monoxide detector as required in accordance with the above provisions shall comply with NFPA 720 and be ANSI/UL 2034 listed and IAS certified.

3. **SIGNAGE.** A metal or plastic identification plate shall be permanently mounted to the exterior of the building at a minimum height of eight (8) feet above grade directly in line with the exhaust vent terminal for the horizontally vented gas fueled heating appliance or equipment. The sign shall read, in print size no less than one-half (½) inch in size, "GAS VENT DIRECTLY BELOW. KEEP CLEAR OF ALL OBSTRUCTIONS".

4. **INSPECTION.** The state or local gas inspector of the side wall horizontally vented gas fueled equipment shall not approve the installation unless, upon inspection, the inspector observes carbon monoxide detectors and signage installed in accordance with the provisions of 248 CMR 5.08(2)(a)1 through 4.

(b) **EXEMPTIONS:** The following equipment is exempt from 248 CMR 5.08(2)(a)1 through 4:

1. The equipment listed in Chapter 10 entitled "Equipment Not Required To Be Vented" in the most current edition of NFPA 54 as adopted by the Board; and

2. Product Approved side wall horizontally vented gas fueled equipment installed in a room or structure separate from the dwelling, building or structure used in whole or in part for residential purposes.

(c) **MANUFACTURER REQUIREMENTS - GAS EQUIPMENT VENTING SYSTEM PROVIDED.** When the manufacturer of Product Approved side wall horizontally vented gas equipment provides a venting system design or venting system components with the equipment, the instructions provided by the manufacturer for installation of the equipment and the venting system shall include:

1. Detailed instructions for the installation of the venting system design or the venting system components; and

2. A complete parts list for the venting system design or venting system.

(d) **MANUFACTURER REQUIREMENTS - GAS EQUIPMENT VENTING SYSTEM NOT PROVIDED.** When the manufacturer of a Product Approved side wall horizontally vented gas fueled equipment does not provide the parts for venting the flue gases, but identifies "special venting systems", the following requirements shall be satisfied by the manufacturer:

1. The referenced "special venting system" instructions shall be included with the appliance or equipment installation instructions; and

2. The "special venting systems" shall be Product Approved by the Board, and the instructions for that system shall include a parts list and detailed installation instructions.

(e) A copy of all installation instructions for all Product Approved side wall horizontally vented gas fueled equipment, all venting instructions, all parts lists for venting instructions, and/or all venting design instructions shall remain with the appliance or equipment at the completion of the installation.

APPENDIX TWO

START

FUNCTION

1.
Press UP and OFF buttons to start ignition sequence. Beep will occur each second.

Yes

2.
Magnet unit is energized thus producing an obvious latching sound.

Yes

3.
Spark will occur each second.

Yes

(continued)

POSSIBLE CAUSE

REMEDY

No →	Transmitter batteries low.	Replace transmitter batteries. Quality alkaline recommended.	
	Receiver batteries low.	Replace receiver batteries. Quality 1.5V AA alkaline recommended.	
	Check that transmitter and receiver are synchronized.	Reset system, see the installation manual or the label on the receiver.	
	Transmitter distance is limited.	1. Straighten the antenna. 2. Replace the receiver.	
No →	No beep →	Impulse magnet not operating properly.	Replace gas valve.
No →	3 short beeps →	Receiver batteries low.	Replace receiver batteries. Quality 1.5V AA alkaline recommended.
No →	1 long beep →	8-wire cable is off or not operating properly.	Confirm proper operation of the 8-wire cable.
		SW-cable disconnected.	Confirm proper operation of the SW-cable.
		Motor not operating properly.	Replace gas valve.
		Micro switch not operating properly.	Replace gas valve.
No →	Ignition components not operating properly.	Check connection between ignition cable and ignition electrode.	
		Check ignition electrode spark gap.	
		Check ignition electrode.	
		Check ignition cable for damage.	
		Increase distance between ignition cable and all metal parts.	
No →	Ignition sequence stops, no pilot flame. No reaction to transmitter command.	Reset system.	
		Remove ground bolt and clean ground lug.	
		Do not coil the ignition cable.	
		Shorten the ignition cable, if possible.	
No →	Ignition sequence stops, no pilot flame. Transmitter command is possible.	Replace receiver batteries. Quality 1.5V AA alkaline recommended.	

APPENDIX TWO

FUNCTION		POSSIBLE CAUSE	REMEDY	
4. Pilot lit.	No →	TC- and SW-cable reversed.	Check cable connection between receiver and interrupter block.	
		Magnet unit not operating properly.	Replace gas valve.	
		Short between interrupter and SW cable.	Check interrupter block connection.	
		No gas (magnet unit drops after 30 second audible count.)	Check gas supply.	
		Spark not lighting the pilot.	Check spark is crossing pilot orifice.	
Yes ↓				
5. Sparking stops after pilot is lit.	No →	Short between interrupter and TC-cable.	Check connection to interrupter block.	
		Electronic measuring amplifier defective.	Replace the receiver.	
Yes ↓				
6. Motor turns to main gas and pilot stays lit.	No →	Resistance in thermocouple circuit too high.	Check thermocouple circuit.	
		Not enough heat on thermocouple.	Check position of pilot to thermocouple and intensity of pilot flame.	
		Low voltage from thermocouple.	Replace thermocouple. Do not over tighten - hand tight + ¼ turn maximum.	
		No gas (magnet unit drops after 30 second audible count.)	Check gas supply.	
	Magnet unit drops (audible sound)	No →	Broken receiver	Ensure powered/unpowered receiver allows manual operation.
			Ignition sequence stops. No reaction to transmitter command.	Reset system.
	Add ground wire between pilot burner and gas valve.			
	Do not coil the ignition cable.			
	Shorten the ignition cable, if possible.			
	Yes ↓			
7. Main burner is lit.	No →	Manual knob is in the "MAN" position.	Turn the control knob to "ON" position (positive latch is required.)	
		Pilot flame is too low.	Confirm correct gas pressure. Increase pilot flame if necessary.	
Yes ↓				
8. Main burner stays lit.	No →	Too much draft at pilot flame (poor flame impingement of thermocouple.)	Check installation.	
		2 nd thermocouple is not heated.	Ensure 2 nd thermocouple is in the flame. Check 2 nd thermocouple wiring.	
Yes ↓				
9. Magnet unit drops while motor turns. 3 beeps.	Yes →	Receiver batteries low.	Replace transmitter batteries. Quality 1.5V AA alkaline recommended.	
No ↓				
NORMAL OPERATION				

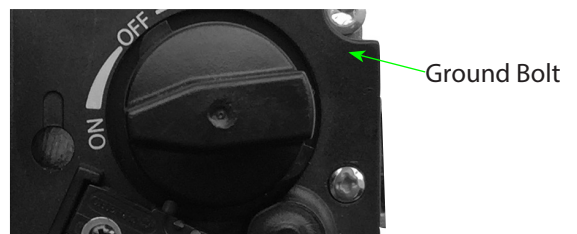

Figure 3.1

APPENDIX THREE



LP (PROPANE) CONVERSION

APPLICABLE MODELS

Modore 240, Tenore 240

CONTENTS

This LP conversion kit contains these instructions plus the following:

- one Pilot Orifice (stamped 27)
- three Main Burner Orifices (stamped 220)

TOOLS REQUIRED

Converting your fireplace to LP gas requires the following tools:

- a 7 mm box/open end wrench
- a 10 mm box/open end wrench
- a 13 mm box/open end wrench
- a 17 mm box/open end wrench
- a No. 2 Phillips screwdriver
- a pair of small needle nose pliers
- a bright work light



WARNING!

This conversion must be done by a licensed plumber or gasfitter.
Turn off the gas supply before proceeding.
Begin by reading all instructions thoroughly.

INSTALLATION

These models have a triple burner and, therefore, three main burner orifices must be replaced.

Step 1: Remove the longest glass panel and carefully store it.

Step 2: Remove all of the fire media.

Step 3: Remove hearth (bottom) panel by lifting it up and out. Figure 1 shows panel removed.

Step 4: Remove the bolts keeping the burner base attached to the firebox.

Orifice and Shutter

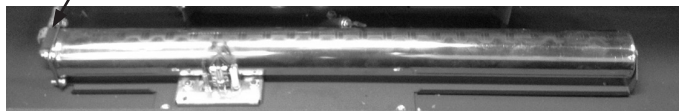

Figure 1.

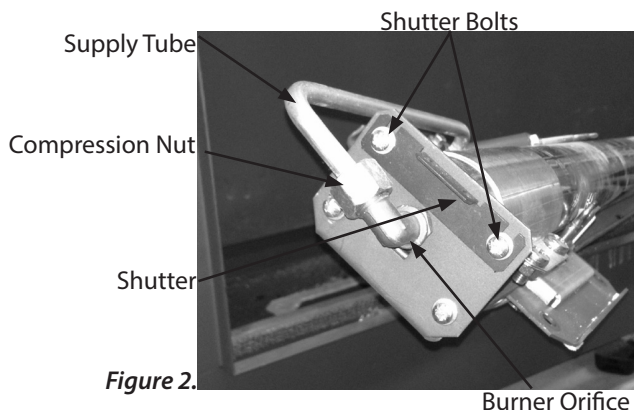

Figure 2.

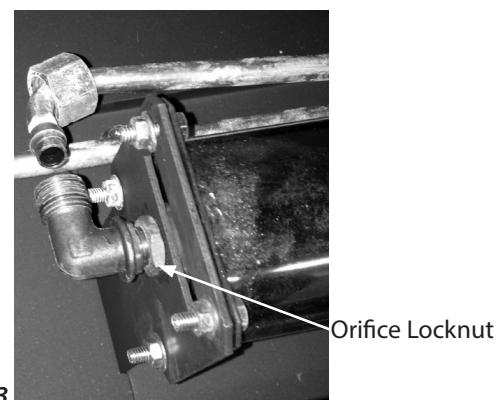

Figure 3.

Step 5: Loosen the top two shutter bolts (7 mm) holding each of the three shutters in place, remove the shutters and tighten the bolts.

Step 6: Remove the compression nuts (17 mm) from each of the orifices and, taking care to not deform the supply tube, slide the supply tube out of the orifice.

Step 7: Loosen the orifice locknut (Figure 3, 13 mm) and unscrew the NG burner orifice from each of the burners

Step 8: Screw an LP orifice into each burner until the orifice is aligned with the supply tube. See Figure 3.

Step 9: Connect the supply tube to each of the burner orifices

APPENDIX THREE

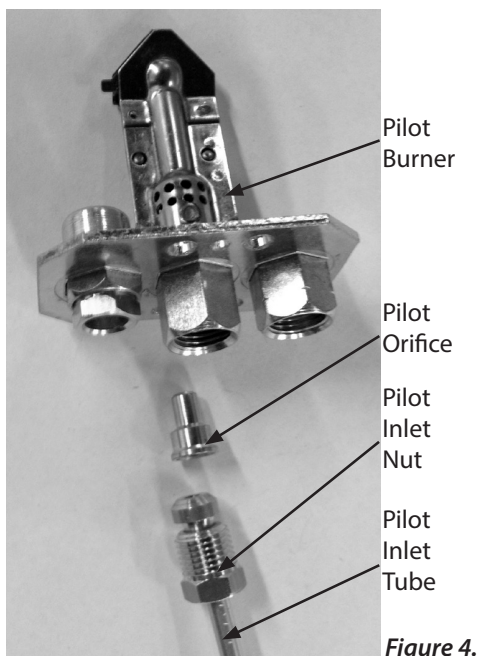

Figure 4.

and tighten the compression nuts.

Step 10: Tighten the orifice locknuts.

Step 11: Remove the pilot burner inlet tube (10 mm) from the pilot burner. See Figure 4.

CAUTION: The next step involves small parts which can be easily lost.

Note: The pilot inlet nut is easily reached at the bottom of the fireplace when the fireplace is tilted slightly rearward. Take care to stabilize the fireplace!

Step 12: Using a 10mm wrench, loosen the pilot inlet nut and remove the pilot burner inlet tube from the pilot burner. The pilot orifice should drop out of the pilot burner. See Figure 4.

Step 13: Remove the pilot burner orifice and replace it with the LP orifice (stamped 27) provided. Take care to observe the proper orientation. See Figure 4.

Step 14: Connect the pilot burner inlet tube and tighten the inlet nut.

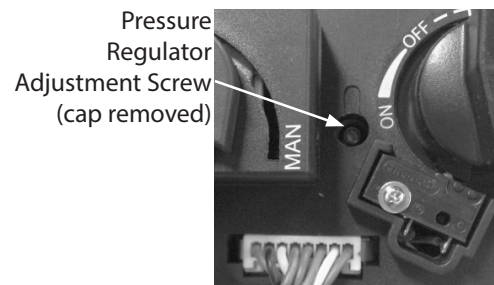

Figure 5.

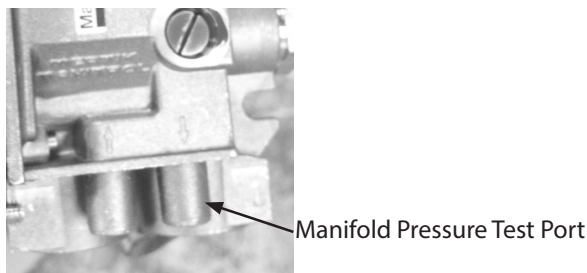

Figure 6.

Step 15: Insert the burner into the firebox and securely fasten with the bolts removed earlier.

Step 16: On the gas valve, between the Manual Knob and the Main Valve Knob is a black plastic cap which hides access to the pressure regulator adjustment screw. Remove black plastic cap to gain access to the pressure regulator adjustment screw. See Figure 5.

Step 17: Connect LP gas supply to fireplace. Loosen the screw inside the manifold pressure test port and connect the manometer to the port. See Figure 6.

Step 18: Turn on the fireplace and set the flames to high. While turning the pressure regulator screw, adjust the manifold pressure to the setting in the installation manual.

Step 19: Turn off the fireplace, remove the manometer and close the test port screw.

Step 20: Replace the hearth panel, the burner media and the glass panel. Check for proper fireplace operation.

To see how to convert the gas on an Element4 fireplace, please visit the link below.

WWW.EUROPEANHOME.COM/RESOURCES/VIDEOS/



APPENDIX FOUR

INSTALLING AN OPTIONAL WALL SWITCH

see Figure 5.1

1. Install a single-gang electrical workbox (not supplied) at the desired location - no more than 26 feet as the cable runs.
2. While keeping the black connector (A) inside the work box, thread the black 4-wire cable through the workbox and bring the red connector (B) to the location of the receiver.
3. Connect the black connector (A) to the wall switch, the red connector (C) to the receiver.
4. Test for proper operation then screw the wall switchplate to the workbox with the two screws provided and attach the faceplate (included).



Figure 5.1

USING THE WALL SWITCH

see Figure 5.2

Note that, with the wall switch, you can turn the fireplace on and off and adjust the flames up and down. *The rear burner, however, can only be turned on/off with the remote control (model applicable).*

- Turn fireplace ON: Press the ON/OFF button until a short beep confirms the start sequence has begun then release the button.
- Increase the flame height: Press and hold the UP button.
- Decrease the flame height: Press and hold the DOWN button.
- For fine adjustment tap the UP or DOWN button as necessary.
- Turn fireplace OFF: Press the ON/OFF button.

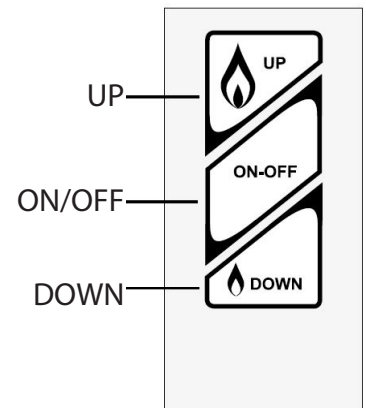

Figure 5.2

INDEX

A

APPLIANCE RATINGS **7**
AC ADAPTER SPECIFICATIONS **7**

C

CERTIFICATION

LISTING LABEL **8**
MASSACHUSETTS **55**

CLEARANCES

DRAWINGS **14**
LOCATION **13**
MANTELS **16**
WARM AIR OUTLET(S) **17**

E

ELECTRIC

REQUIREMENTS **18**
AC ADAPTER SPECIFICATIONS **7**

ENCLOSING THE FIREPLACE **28**

F

FIRE MEDIA

INSTALLING THE LOGSET **41**
INSTALLING THE STONES **43**

FIRST FIRE **39**

G

GAS

CONVERTING TO LP **58**
INSTALLING THE GAS LINE **18**
PRESSURES **7**

L

LISTING LABEL **8**
LP (PROPANE) CONVERSION **58**

M

MAINTENANCE

BURNER **52**
PILOT **52**
THERMOCOUPLES **53**
VENT **53**

MANTELS **16**

N

NON-COMBUSTIBLE MATERIALS

MINIMUM CLEARANCES **13**

O

OPERATING THE FIREPLACE

TEST FIRE **39**
USING THE REMOTE CONTROL **37**
USING THE WALL SWITCH **60**

P

PARTS OF THE FIREPLACE **11**

S

SAFETY INFORMATION **3**
SPECIFICATIONS

APPLIANCE RATINGS **7**
DIMENSIONS - MODORE 240 **9**
DIMENSIONS - TENORE 240 **10**

V

VENTING

CONFIGURATION **19**
HORIZONTAL TERMINATIONS **21**
VERTICAL TERMINATIONS **24**

W

WARRANTY **54**

Imported and distributed in North America by:



EUROPEAN HOME
a division of Europa Ja, Inc.
376 Washington Street
Suite 203
Malden, MA 02148
www.europeanhome.com