

# Installation & Maintenance Manual



30FID Traditional

I-Series  
Indoor  
Residential  
Fireplace Insert

## **WARNING**

### **FIRE OR EXPLOSION HAZARD**

Failure to follow safety warnings exactly could result in serious injury, death, or property damage.

- Do not store or use gasoline or other flammable vapors and liquids in the vicinity of this or any other appliance.
- WHAT TO DO IF YOU SMELL GAS
  - Do not try to light any appliance.
  - Do not touch any electrical switch; do not use any phone in your building.
  - Leave the building immediately.
  - Immediately call your gas supplier from a neighbor's phone. Follow the gas supplier's instructions.
  - If you cannot reach your gas supplier, call the fire department.
- Installation and service must be performed by a qualified installer, service agency or the gas supplier.

## **NOTICE**

Installer: Leave this manual with the appliance.  
Consumer: Retain this manual for future reference.



# NOTICE

You must read and understand this manual prior to installation, operation or troubleshooting this appliance. Please retain this owner's manual for future reference and maintenance.

## Table of Contents

Instruction Manual Contents		<b>Connecting Power</b> .....	<b>34</b>
<b>Safety Alerts</b> .....	<b>3</b>	Battery Installation / Replacement.....	34
<b>Introduction</b> .....	<b>4</b>	<b>Brick Panel Installation</b> .....	<b>35</b>
<b>Section 1: Product Dimensions</b> .....	<b>7</b>	<b>Porcelain Panel Installation</b> .....	<b>36</b>
Standard Trim.....	7	<b>Log Installation</b> .....	<b>38</b>
Standard Trim with Offset Kit.....	8	<b>Operation</b> .....	<b>42</b>
Oversized Trim.....	9	Initial Operation.....	42
Four-sided Trim.....	10	Master Override Switch.....	43
<b>Section 2: Installation</b> .....	<b>11</b>	Aeration Adjustment.....	45
Install Dimensions:.....	11	Remote Operation.....	46
Clearances:.....	11	Burner Installation / Removal.....	52
Non Combustible Board Install.....	12	Burner Installation.....	53
<b>Section 3: Venting</b> .....	<b>13</b>	Accent Light Replacement.....	54
Approved Vent Components.....	13	Optional Fan / Blower Replacement.....	54
Vent Configurations.....	14	Window Cleaning / Screen Removal.....	57
<b>Section 4: Unpacking</b> .....	<b>16</b>	Battery Replacement.....	58
Standard Faceplate Kit.....	17	Heat Exchanger Bypass.....	58
<b>Door Installation &amp; Removal</b> .....	<b>18</b>	Pilot Maintenance / Replacement.....	60
<b>LP Conversion</b> .....	<b>19</b>	Control Board Replacement.....	63
Gas line connection.....	24	Control Board Fuse Replacement.....	64
Fuel Supply + Manifold Pressure Checking.....	25	Vent Maintenance / Inspection.....	65
<b>Faceplate Installation</b> .....	<b>26</b>	SIT Proflame 2 Troubleshooting:.....	66
Standard Faceplate Offset Installation.....	26	Appendix A: Warranty.....	67
Standard or Oversized Faceplate Installation.....	27	Appendix B: State of Massachusetts.....	68
Four Sided Faceplate Installation.....	30	<b>Replacement Parts</b> .....	<b>69</b>
<b>CPI [Continuous Pilot Ignition] / IPI [Intermittent Pilot Ignition] Jumper Cable Installation</b> .....	<b>33</b>		
<b>Leveling the Unit</b> .....	<b>34</b>		

# Safety Alert Legend



## DANGER

Indicates a hazardous situation which, if not avoided, **WILL** result in death or serious injury or property damage.



## WARNING

Indicates a hazardous situation which, if not avoided, **COULD** result in death or serious injury or property damage.



## CAUTION

Indicates a hazardous situation which, if not avoided, **WILL** result in minor or moderate injury.

## NOTICE

Addresses practices that are important, but not related to personal injury

# Safety Alerts

### Safety Alerts



## WARNING

If the information in these instructions is not followed exactly, a fire or explosion may result causing property damage, personal injury or death.



## WARNING

Do not store or use gasoline or any other flammable vapors and liquids in the vicinity of this or any other appliance.



## CAUTION

Installation and service must be performed by a qualified installer, service agency or the gas supplier.



## DANGER



**HOT GLASS WILL CAUSE BURNS.  
DO NOT TOUCH GLASS UNTIL COOLED.  
NEVER ALLOW CHILDREN TO TOUCH GLASS.**

A barrier designed to reduce the risk of burns from the hot viewing glass is provided with this appliance and shall be installed for the protection of children and other at-risk individuals.



# Introduction

## Introduction

Congratulations on your purchase of a **Montigo Fireplace**.

With over 30 years of experience, Montigo is committed to providing you with a gas fireplace that is not only a beautiful addition to your space, but that is also designed and manufactured to the highest safety, reliability and engineering standards.

We strongly encourage you to read and carefully follow the instructions laid out in this Installation, Operation and Maintenance Manual and retain it for your future reference. Pay special attention to all cautions, warnings, and notices throughout this manual intended to ensure your safety.

This manual covers installation, operation and maintenance. Lighting, operation and care of this fireplace can be easily performed by the homeowner. All installation and service work should be performed by a qualified or licensed installer, plumber or gas fitter as certified by the state, province, region or governing body where the fireplace is being installed.

This installation, operation and maintenance manual is applicable to the models described below. Refer to your rating plate to verify included options.

## Warranty and Installation Information: (See Appendix B)

The Montigo warranty will be voided by, and Montigo disclaims any responsibility for, the following actions:

- ▶ Modification of the fireplace and/or components including Direct-Vent assembly or glass doors.
- ▶ Use of any component part not manufactured or approved by Montigo in combination with this Montigo fireplace system.
- ▶ Installation other than as instructed in this manual.

Consult your local Gas Inspection Branch on installation requirements for factory-built gas fireplaces. Installation & repairs should be done by a qualified contractor.

This appliance is equipped for altitudes from 0 - 4500 feet [0 -1370 m]. For higher altitudes contact your Montigo dealer.

<b>Model Number</b>	<b>30FIDN-S-F [NG]</b>	<b>30FIDL-S-F [LP]</b>	
<b>Part Number</b>	<b>30FIDNIS-01</b>	<b>30FIDLIS-01</b>	
<b>Input Rating</b>	<b>24,000 BTU</b>	<b>23,000 BTU</b>	
<b>Gas Supply Pressure</b>	<b>7" WC</b>	<b>11" WC</b>	
<b>Manifold Pressure</b>			
<b>High</b>	<b>3.5"</b>	<b>10"</b>	
<b>Low</b>	<b>2.2"</b>	<b>6.4"</b>	
<b>Orifice Size (DMS)</b>	<b>41</b>	<b>54</b>	
<b>Pilot Orifice Size (No.)</b>	<b>62</b>	<b>35</b>	
<b>Air Shutter Min Settings</b>	<b>1/16"</b>	<b>3/16"</b>	
<b>Electrical Requirement</b>	<b>115 VAC, 60Hz</b>	<b>115 VAC, 60Hz</b>	
<b>Vent Size</b>	<b>3"</b>	<b>3"</b>	<b>Aluminum / Stainless Flex</b>
<b>Minimum Vent Length</b>	<b>10'</b>	<b>10'</b>	
<b>Maximum Vent Length</b>	<b>36'</b>	<b>36'</b>	
<b>Efficiency AFUE Method</b>	<b>71.30%</b>	<b>71.30%</b>	
<b>Efficiency P.4 Method</b>	<b>78.8%</b>	<b>80.1%</b>	
<b>Clearances</b>			
<b>Mantel</b>	<b>16"</b>	<b>16"</b>	
<b>Hearth</b>	<b>0"</b>	<b>0"</b>	
<b>Side Wall</b>	<b>7 7/8"</b>	<b>7 7/8"</b>	
<b>Control Type</b>	<b>SIT Proflame 2</b>	<b>SIT Proflame 2</b>	
<b>Light Bulb Specification</b>	<b>20W, G6.35, Qty 2</b>	<b>20W, G6.35, Qty 2</b>	
<b>Fuse Specification</b>	<b>3.15Amps</b>	<b>3.15Amps</b>	
<b>Fan Amperage</b>	<b>1.6Amps</b>	<b>1.6Amps</b>	
<b>Certification(s)</b>	<b>Ansi Z21.88-2014 / CSA 2.33-2014 VENTED GAS FIREPLACE HEATERS</b>		
	<b>CGA 2.17-M91 [R2009] GAS FIRED APPLIANCES FOR HIGH ALTITUDES</b>		
	<b>CSA P.4.1-09 [R2014] Fireplace Efficiency</b>		

# Introduction



## Before You Begin

### IMPORTANT MESSAGE: SAVE THESE INSTRUCTIONS

The **I-Series** insert fireplace must be installed in accordance with these instructions. Carefully read all the instructions in this manual prior to installation or operation. Consult the Local Gas Branch to determine the need for a permit prior to starting the installation. It is the responsibility of the installer to ensure this fireplace is installed in compliance with the manufacturers instructions and all applicable codes.

### Installations into a Factory Built Solid fuel Burning Fireplace

This gas appliance has been tested and approved for installation into any approved masonry or factory built solid fuel fireplace, in which this gas insert will fit.

In the event that the vertical height of the factory built fireplace is less than 20" you may remove some of the components such as the flue baffle, flue damper or surround panels. These components can be removed on the condition that:

- 1). The removal of such components in no way compromises the structural integrity of the unit.
- 2). A label supplied with your insert is prominently affixed to the existing fireplace. This label can be found included in the bag that contains the back-up batteries for the insert.

The bottom of the existing fireplace may be removed as long as it does not compromise the structural integrity of the existing fireplace and you maintain a mandatory minimum 3/4" clearance between the bottom of the insert and the bottom shell of the existing fireplace. This can be achieved by using strips of noncombustible material or by using the leveling bolts on the insert.

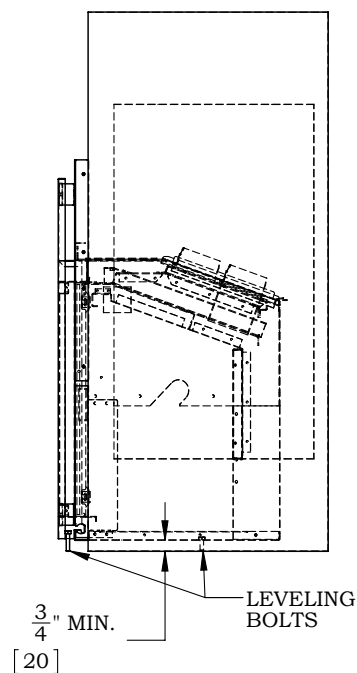
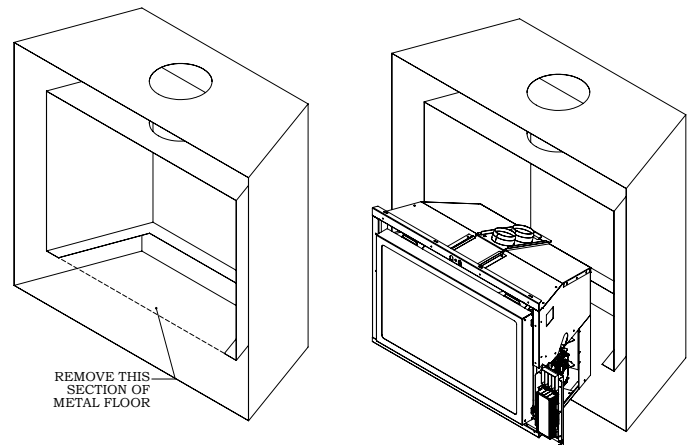

**⚠ WARNING**

This fireplace has been converted for use with a gas insert fireplace. The conversion of this fireplace voids its original certification and this appliance can no longer be used as a solid fuel burning fireplace.

Figure 1 Sec.1



# Introduction

**Rating label:**

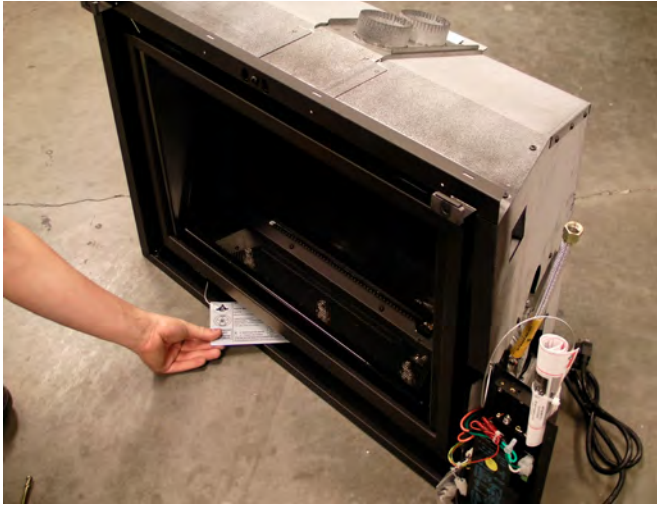

Figure 2 Sec.1 Rating label location

**Rating label sample: Natural Gas Sample Shown**

<b>*Clearance to Combustibles *Degagements Aux Combustibles</b>	
Sides/Côtés:	NC
Back/Derrière:	NC
Top-Top Vent/Du Haut-Évent Du Haut:	NC
Top-Rear Vent/Du Haut-Évent Arrière:	N/A
Floor/Plancher:	0"
Mantel/Manteau:	16"
Recess Depth/Profondeur D'Encadrement:	N/A
Min. Vent Height:	10"

<b>Vented Gas Fireplace Heater</b>		<b>For Indoor Use Only</b>	
Not for use with solid fuel. / Pas pour l'usage avec le combustible solide.		Not for use with air filters. / Pas pour l'usage avec des filtres à air.	
30FID-S-F 30FIDNIS -01		2-150911-000000	
Canadian Heating Products Inc., Langley BC, (www.montigo.com)		Montigo DelRay Corp., Ferndale, WA. (www.montigo.com)	
<b>ANSI Z21.88 / CSA 2.33-2014</b>		<b>ANSI Z21.88 / CSA 2.33-2014</b>	
Electrical Rating / Estimation Électrique: 115V / 1Ph / 60Hz / less than 12A		Altitude Rating / Estimation D'Altitude: N & H ( 0 - 4500 ft. / 0 - 1371 m.)	
Fuel Type / Type De Carburant:		Output / Rendement	
<input checked="" type="checkbox"/> N - Natural Gas / Gaz Naturel	<input type="checkbox"/> LP - Propane / Gaz Propane	Max. Input Max. Entrée BTU/H	Min. Input Min. Entrée BTU/H
		24,000	20,000
		23,000	19,000
		Orifice Size / Taille D'Orifice	Front/Avant
		Rear/Derrière	1@ 41 DMS / N/A
		1@ 54 DMS / N/A	

**\*Refer to installation manual for more information.**  
\*Référez-vous au manuel d'installation pour plus d'information.

**FOR USE WITH GLASS DOORS AND SCREENS CERTIFIED WITH THE APPLIANCE ONLY**  
Pour utilisation avec portes de verre and écrans de certifiés avec l'appareil seulement

LabelView Demo



**Do Not Remove This Label**  
**N'enlevez Pas Cette Étiquette**

# Introduction



## Section 1: Product Dimensions Standard Trim

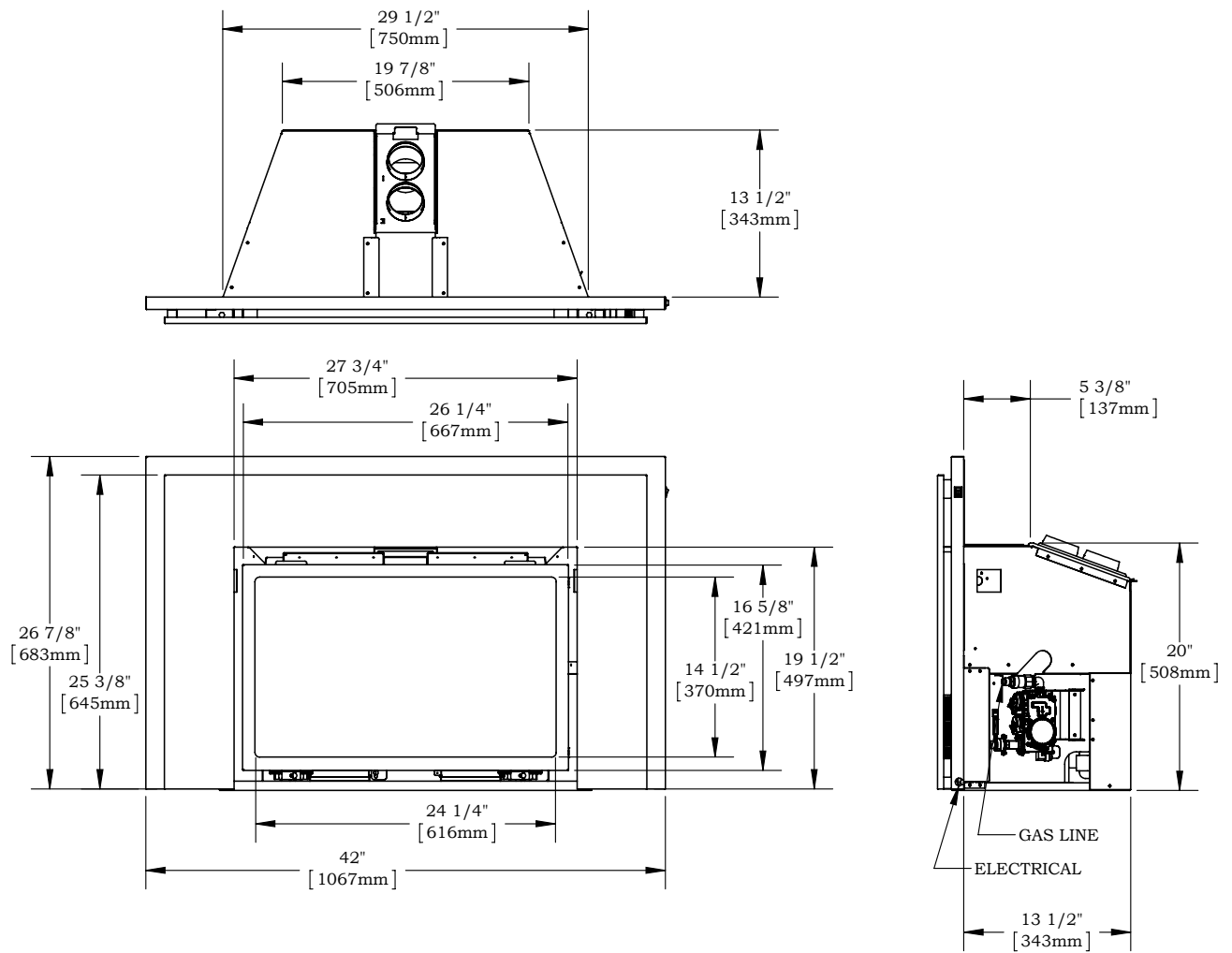

Figure 3 Sec.1 30DFID-S standard trim dimensions (Tolerance  $\pm 1/8"$ ) [1.25 mm]



# Introduction

## Section 1: Product Dimensions Standard Trim with Offset Kit

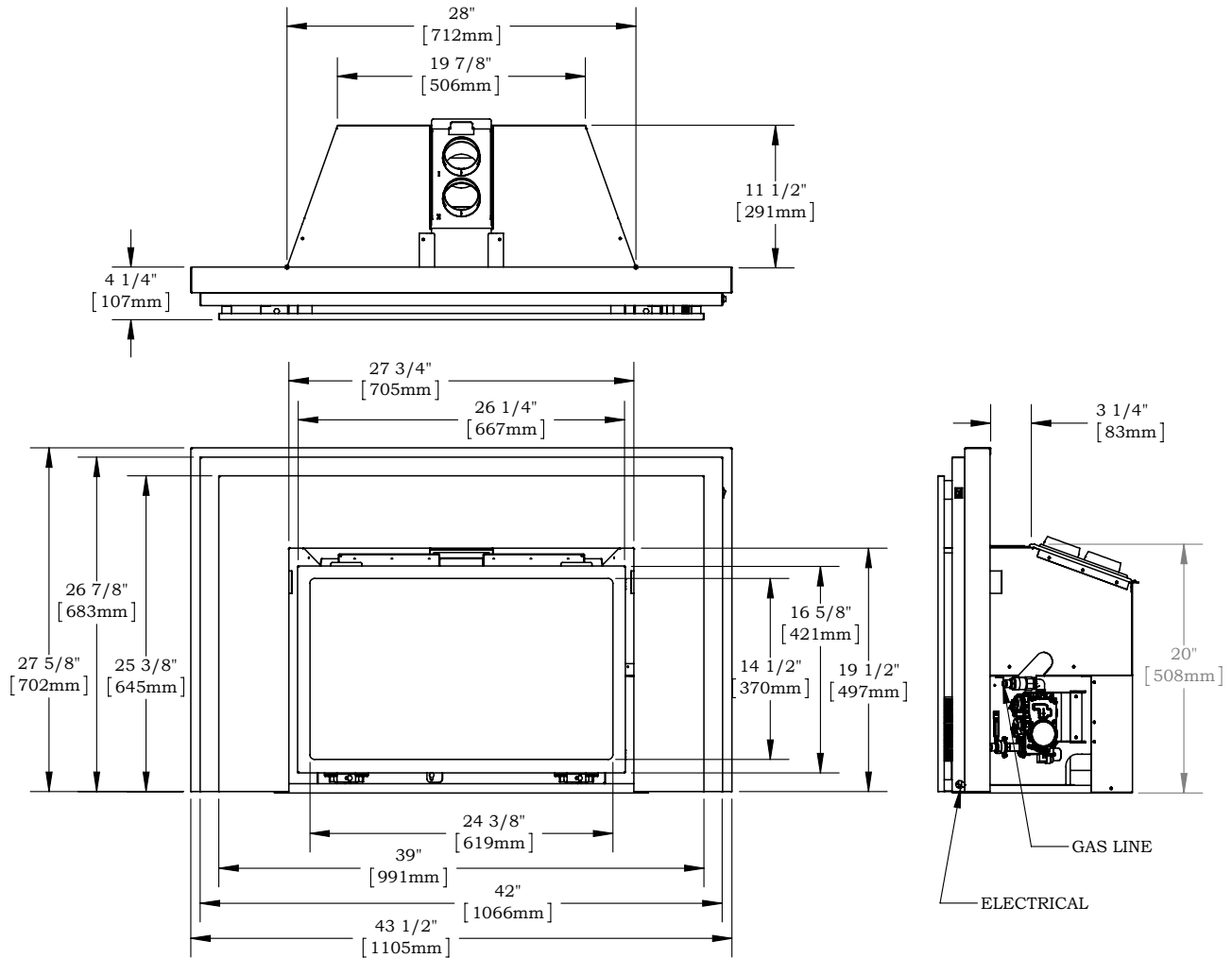

Figure 4 Sec.1 30DFID-S offset trim dimensions (Tolerance  $\pm 1/8"$ ) [1.25 mm]



# Introduction



## Section 1: Product Dimensions Oversized Trim

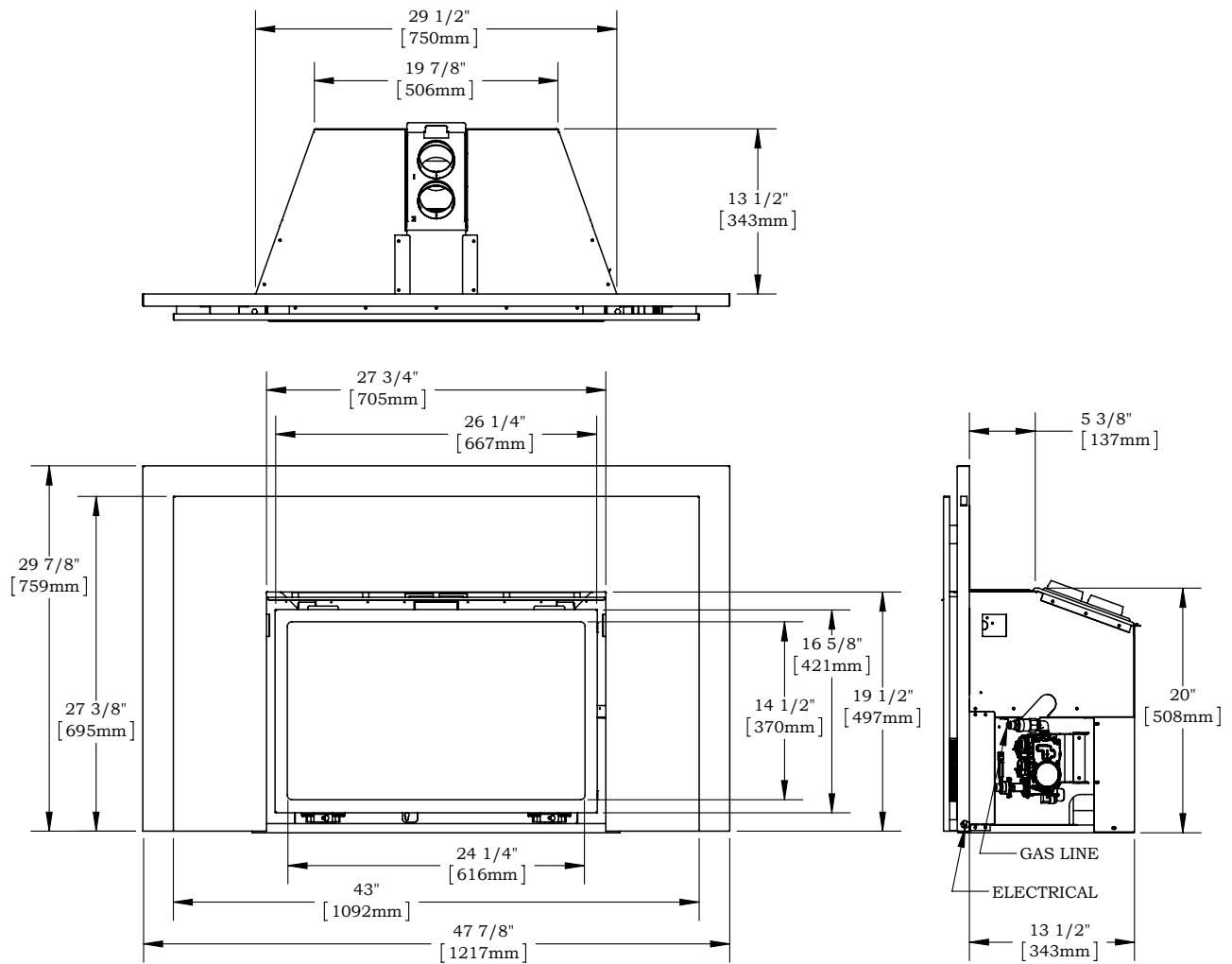

Figure 5 Sec.1 30DFID-S oversized trim dimensions (Tolerance  $\pm 1/8"$ ) [1.25 mm]



# Introduction

## Section 1: Product Dimensions Four-sided Trim

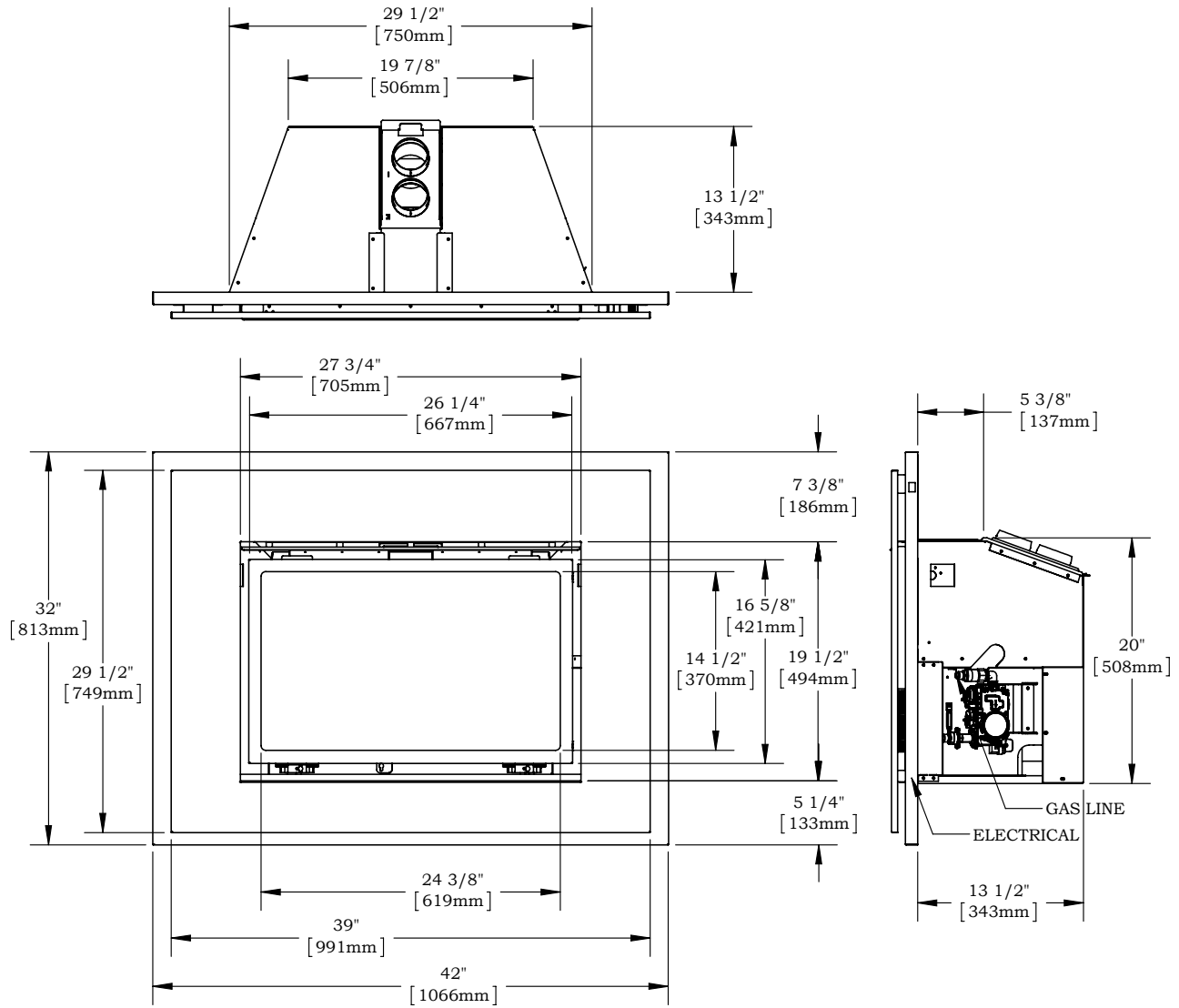

Figure 6 Sec.1 30DFID-S four-sided trim dimensions (Tolerance  $\pm 1/8"$  [1.25 mm])

# Installation



## Section 2: Installation

### Install Dimensions:

The install size requirements of your fireplace insert are dependent on several factors. Gas line location, electrical connection and gas line type can play into what the minimum installation size can be. The diagram below illustrates the smallest possible size requirement of this model. Please take into consideration these other factors when determining if this appliance will fit into your masonry or manufactured fireplace.

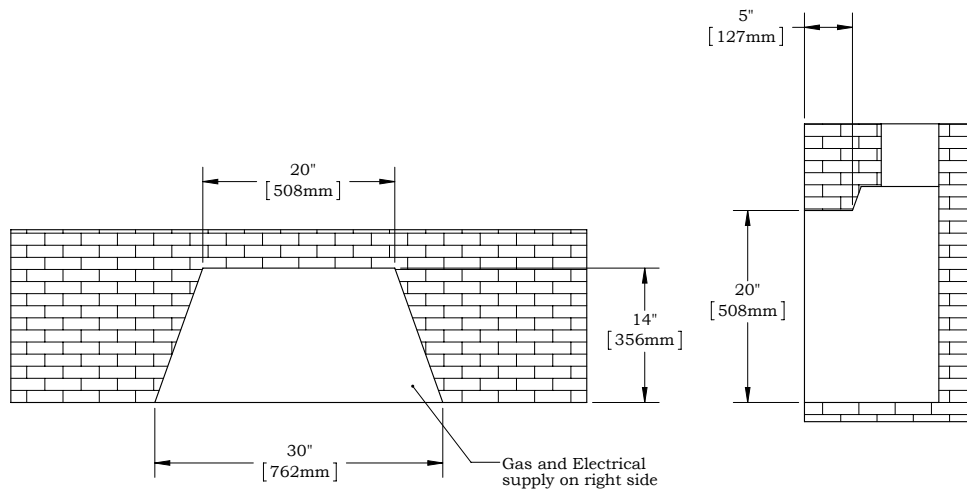

Figure 1 Sec.2 30DFID-S installation dimensions (standard trim)

### Clearances:

The 30DFID-S Insert is designed and built to be installed into masonry or manufactured fireplaces. There is no requirement to have a non-combustible hearth in front of the unit. Clearances to the underside of the mantel or sidewall are measured from the edge of the door/screen front. The Mantel is shown as 10" maximum at a distance of 16" minimum from the door edge top. The mantel can be extended further providing that you increase the height proportionately. For instance, if you want a mantel that is 2" beyond the 10" minimum, you have to install it 2" above the 16" minimum.

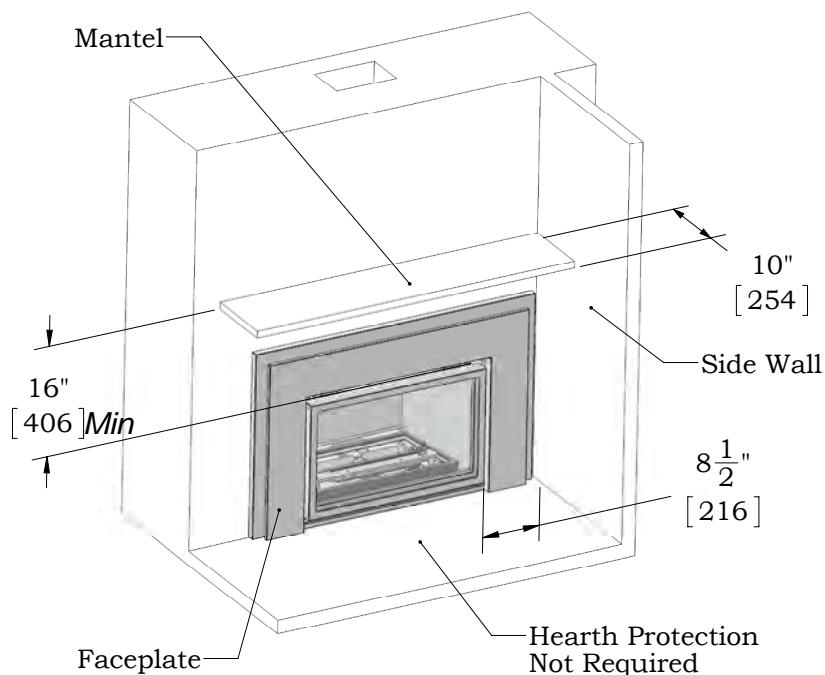

Figure 2 Sec.2 30DFID-S Clearances



# Installation

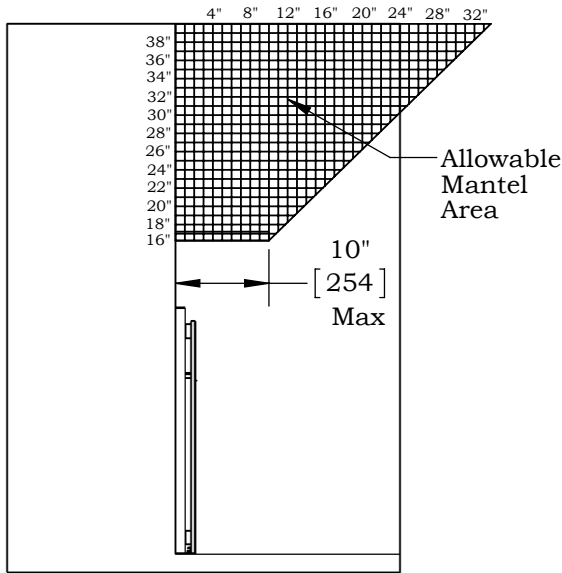
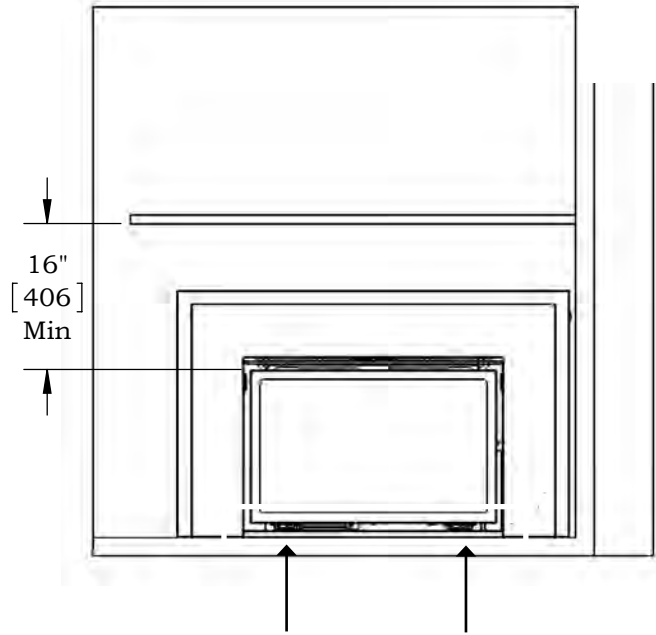

Figure 3 Sec.2 30FID-S Mantel Clearances



**⚠ WARNING**

Do not place any materials or objects in front of door relief. Doing so could result in failure of door relief system or heat dissipation.

## Non Combustible Board Install

Non combustible facing materials must be used above the unit, up to the minimum required mantel height clearance and for the entire width of the fireplace opening. This includes all types of possible installations.

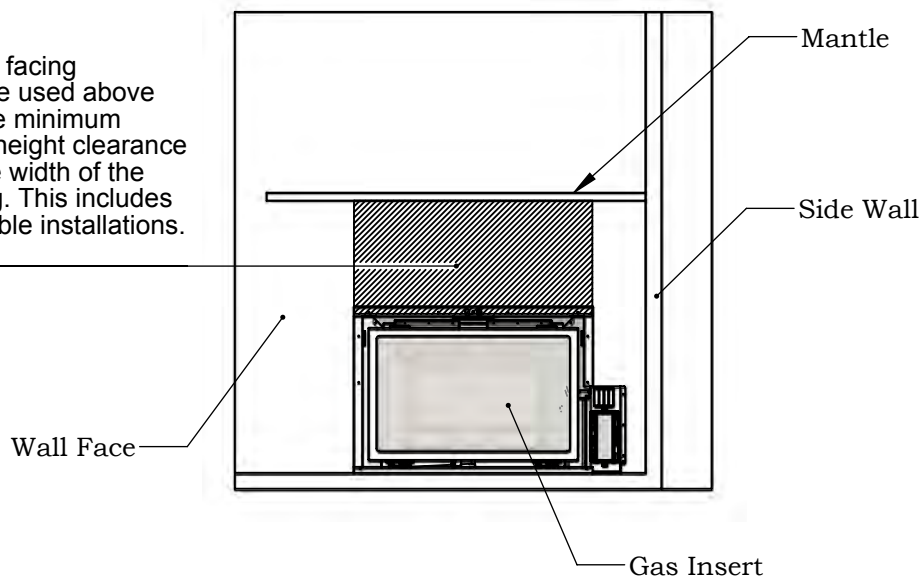

Figure 4 Sec.2 Non Combustible Board Install

# Installation



## Section 3: Venting

### Approved Vent Components

Your Montigo 30FID is approved to be installed with the following venting components:

#### Termination

46DVA-VCH, Duravent Vertical, High Wind Termination

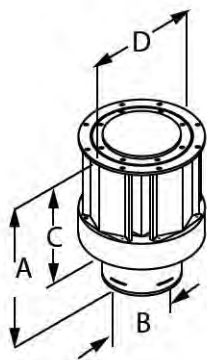

SIZE	ORDER #	A	B	C	D
4" x 6 5/8"	46DVA-VCH	12 3/8"	6 5/8"	7 5/8"	10 1/2"

#### Adaptor

46DVA-GK, Duravent 3" x 3" to 4" x 5 5/8" Co-linear to Co-axial Adaptor

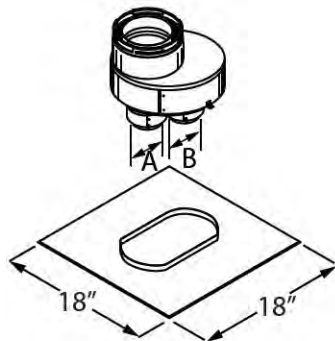

SIZE	ORDER #	ØA	ØB
4" x 6 5/8"	46DVA-GK	3"	3"

#### Connectors

3DFA-FC, Duravent 3" Flex Liner Coupling

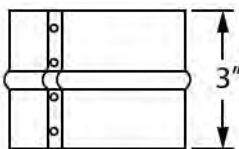

SIZE	ORDER #
3"	3DFA-FC

#### Venting

3" Flex Liner Coupling



#### MONTIGO

LENGTH	ORDER #
35'	VT35FL3 BC



# Installation

## Vent Configurations

This appliance can only be vented vertically. The minimum vent height measured from the floor under the unit to the bottom of the termination is 10'. The maximum height that a vent can extend is 36'. This unit uses 3" x 3" Co-linear venting. This is a direct vent unit and as such requires that both intake and exhaust vents are connected and operational. Using existing chases as a partial vent mechanism is not allowed. Due care is required to ensure that all vent components are properly connected and sealed. Care must also be taken when installing flashing or termination caps to make sure that the structure of the building cannot be subject to water penetration. Proper roofing and chimney finishing techniques must be used.

## Steps for vent connection

**\*\* Before installing the venting system, make sure that any dampers or baffle plates in the fireplace are removed or do not present any hindrance to your installation \*\***

- 1). Determine the length of flex venting that will be required. Cut 2 lengths a couple of feet longer than you anticipate needing. The length of these needs to be determined after the vent is stretched out. Flex venting generally comes compressed and needs to be stretch out to meet the lengths as specified.
- 2). From the roof, attach the Vent Lengths to the Adaptor. Don't forget to have the Flashing placed between the Flex Vent and the Adaptor before attaching the Flex Vent.
- 3). Using commercial grade sealant around the perimeter of the Collars of the Adaptor, use a minimum of 3 Tech screws in each Vent.
- 4). Install the Termination to the top of Adaptor. Use a minimum of 4 tech screws to attach the Termination to the Adaptor.
- 5). Feed the Flex Venting down the chimney until the Adaptor is situated near the top of the Chimney. Use a commercial grade of sealant between the Flashing and the Chimney top. Fasten the Flashing to the top of the Chimney using a fastening method that will properly secure the flashing permanently.
- 6). Attach the Adaptor to the top of the Flashing using 4 tech screws. Seal around the perimeter of the Adaptor where it meets the Flashing.
- 7). From inside the house check how long the vents protrude into the Fireplace. Read the section on installation where fuel supply pressure checking needs to be done. This procedure can be done at this point by installing the venting to the appliance prior to pushing the appliance into the fireplace cavity.
- 8). Once pre-installation steps have been completed, trim the vent length to the correct length for installation. The Correct length will leave the Flue Collar Slide Plate suspended around 18-19 inches from the floor of the Fireplace.
- 9). Remove the Flue Collar Slide Plate from the appliance. Attach both flex ends to the Flue Collar Slide plate. Use a commercial high temp sealant around the Flue Collars on Flue Collar Slide Plate before installing the Venting. Use a minimum of 3 tech screws to properly secure the Venting to the Flue Collar Slide Plate.

**\*\* Make certain that the Exhaust and Intake Vents are connected to the correct collars on the Flue Connection Plate. If they are connected in reverse, this unit will not operate and re-installation will be necessary. \*\***

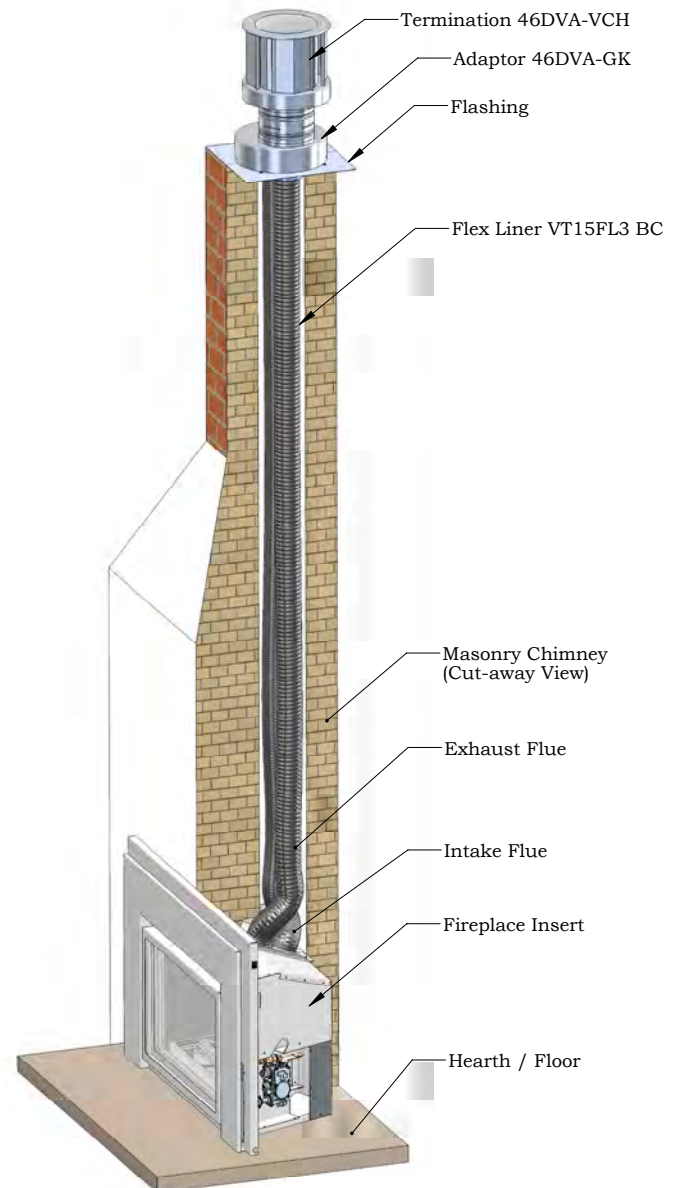

Figure 1 Sec.3

# Installation



\*\* For clarity, the pictures in this section show the Fireplace Insert in an open room. You will be performing these tasks in the Fireplace as you complete this installation \*\*

**10).** Using the Door Opening Tool provided with the Fireplace Insert, insert the tool through the Outer Shell of the Fireplace Insert. You will be inserting this tool through a keyhole on front edge of the Flue Collar Slide Plate.



Figure 2 Sec.3

**11).** The Flue Collar Slide Plate needs to be engaged into the Slide Plate Retainers as you pull it forward.

**12).** You will slowly slide the Fireplace Insert back into the Fireplace Cavity. At the same time, you will be pulling the Flue Slide Plate forward onto the Fireplace Insert.

\*\* Be extremely careful that the Gasket between the Fireplace Insert and the Flue Collar Slide Plate isn't damaged and remains in the correct position. Failure of this gasket will greatly diminish the operation of this appliance. \*\*

**13).** Make certain that when the Flue Collar Slide Plate comes forward that the tab at the back of the appliance engages into the Flue Collar Slide Plate. Without this engagement, the Flue Collar Slide Plate will not seal against the Gasket and the unit will not function.

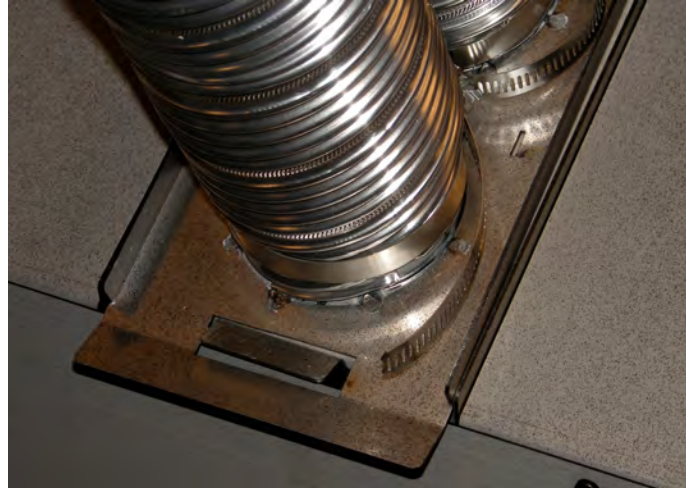

Figure 3 Sec.3

**14).** Once the Flue Collar Slide Plate is within 1" of the front, Use the 1/4" NC screw supplied and secure the Flue Collar Slide Plate to the front of the Fireplace Insert



Figure 4 Sec.3



# Installation

## Section 4: Unpacking

While unpacking your new fireplace, take special care to ensure that all the components shown here are included in your shipment and that all components are received in good condition. Please notify your retailer directly if there are any discrepancies with your shipment.



Figure 1 Sec.4 Opening the fireplace carton

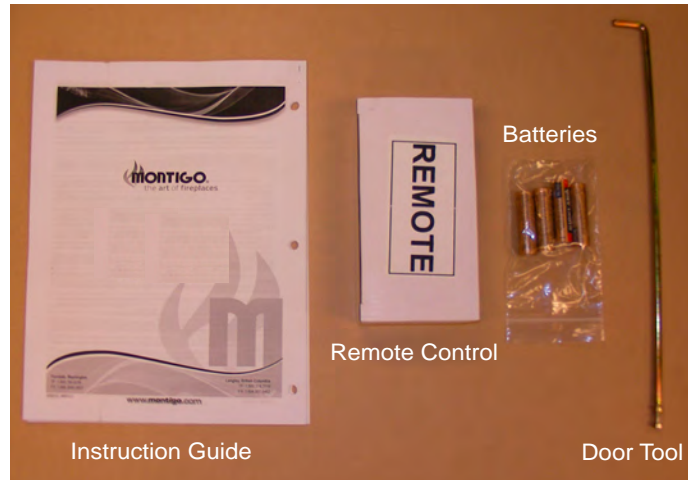

Figure 3 Sec.4 Items included in fireplace carton.



Figure 2 Sec.4 Top of the unit



Figure 4 Sec.4 Front of unit unpackaged.

### Additional Items Required To Be Ordered Separately

- Faceplate Kit
- Firebox Liners
- Venting
- Termination

See price list for ordering information

Note: Log set is included in firebox order, but is packaged separately.



# Installation



## Standard Faceplate Kit

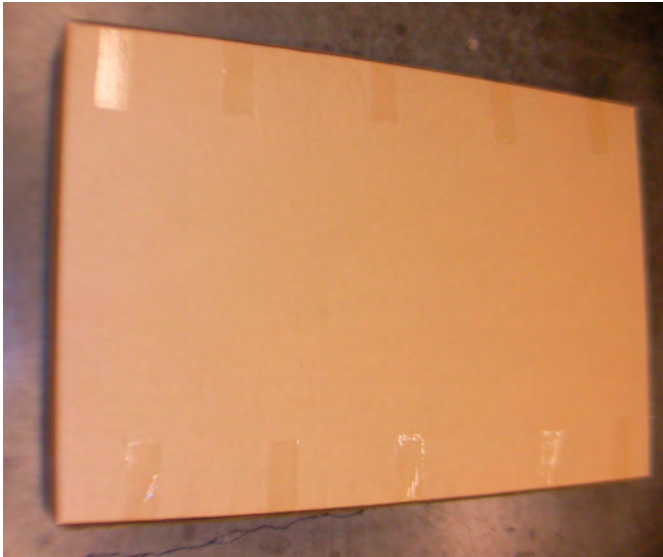

Figure 5 Sec.4 Faceplate Trim Box (standard trim)

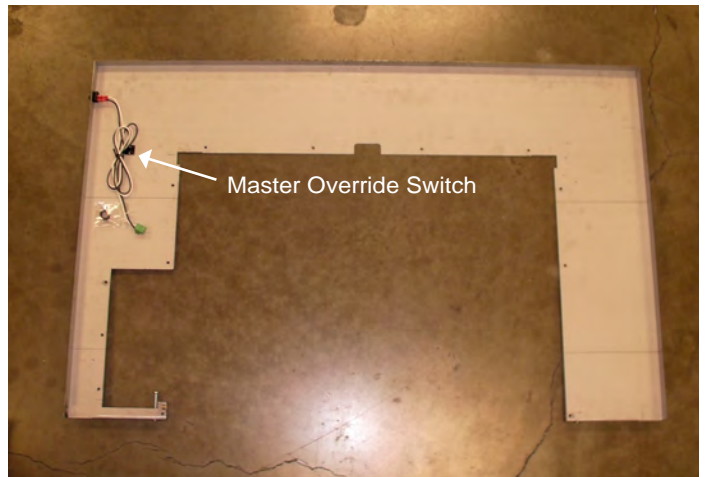

Figure 8 Sec.4 Back of Rear Faceplate



Figure 6 Sec.4 Supplied Screws



Figure 9 Sec.4 Suppled electrical strain relief and zap strap

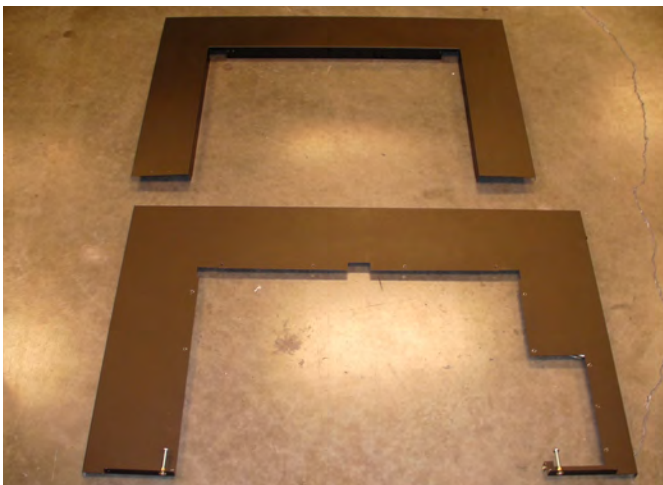

Figure 7 Sec.4 Front and Rear Standard Faceplates



# Installation

## Door Installation & Removal

This appliance is supplied with a safety screen installed. The Safety Screen is attached to the fireplace door using 4 screws, and can be removed when necessary for outer glass cleaning.

The Fireplace Door is attached to the Firebox by 2 tabs mounted to the top of the Firebox and by 2 spring loaded retainers at the bottom, underneath the Door. The Retainers at the bottom of the unit are manipulated using a Door Tool that is supplied with the unit. The general operation of the Door Retainers is:

### WARNING

When reinstalling door(s), always make sure all door buckles are properly hooked and fully engaged.

- a). Engage the Door Tool into the Door Retainer
- b). Move the Door Tool to the left to release the Door Retainer
- c). Move the retainer downward and then back underneath the Door
- d). Swing the Door outward from the unit and then lift the Door up and over the top Tabs



Figure 1 Sec.5 Door Retainer / Bottom of Door

Engage door tool into door retainer. Push door tool left, disengaging the door retainer from the door.

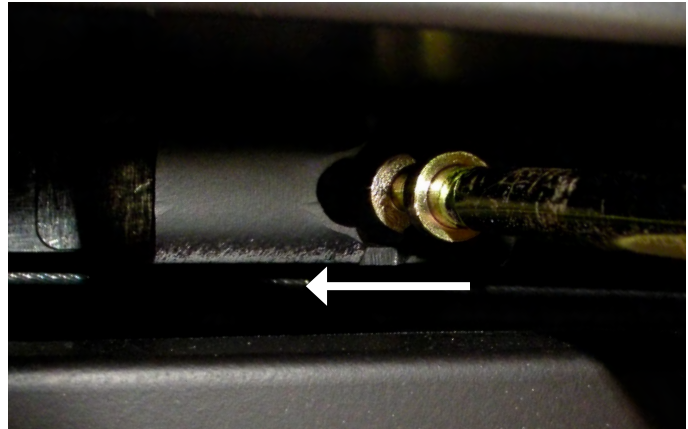

Figure 2 Sec.5 Insert Door Tool and slide left.

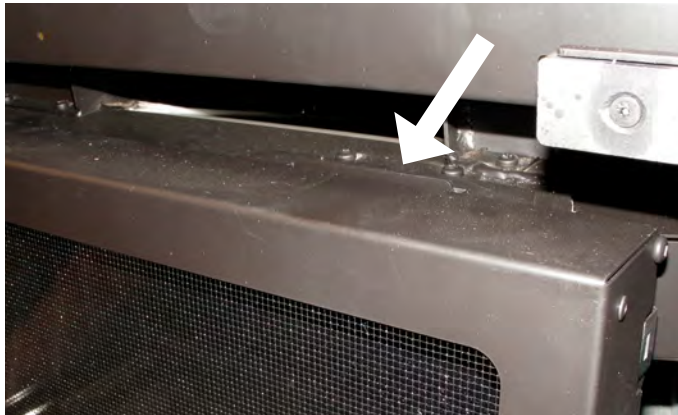

Figure 3 Sec.5 Door Retainer released.



Figure 4 Sec.5 Swing the Door away from the unit, lift over the retaining tabs on top of the firebox. Be careful to not roll the gasket up off the glass when reinstalling the door. Installation is the reverse of removal.

# Installation



**Figure 5 Sec. 5 Location of Door retainer tabs**

**Check that the door retainers are properly engaged. If they are not the door relief system may not operate properly. This can cause a risk of injury or improper operation of the appliance.**

## **WARNING**

When installing the fireplace - gas lines, fittings, accessories or any other objects cannot impede the proper movement of the door buckles.

## LP Conversion

The 30FID-S is available in Natural Gas or Liquid Propane versions. If you have a Natural Gas unit and would like to burn Propane you can purchase an optional LP conversion kit and install it using the following steps. To convert the unit to LP, the unit must be disconnected from any gas supply, disconnected from any electrical supply and batteries and removed from any installation cavity.

The 6 major items that need modification to convert a unit to LP

- 1). Variable regulator on the gas valve
- 2). The main burner orifice
- 3). The pilot burner orifice
- 4). Set minimum primary air tab
- 5). Label on the valve showing the new specifications
- 6). Gas fitter conversion label



**Figure 1 Sec.6 LP conversion kit showing pilot orifice, main burner orifice, LP stepper motor, zap strap and gas fitter conversion label.**

## Tools required

- 1). Torx T20 Screw Driver Bit
- 2). 3/8" Socket Driver
- 3). 5/32" Allen Key
- 4). Needle Nose Pliers or Small Flat Head Screw Driver



# Installation

## Converting the gas regulator on the valve

1). On the right side (control side) of the unit, remove 2 screws that enable the valve to swing away from the unit.

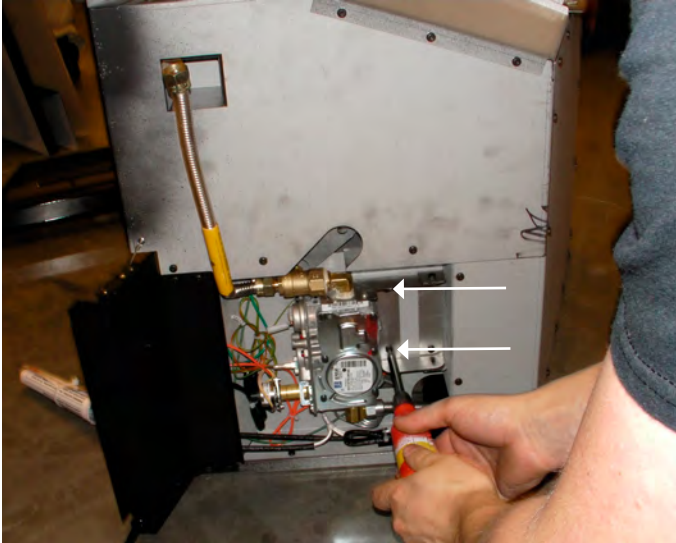

Figure 2 Sec.6

2). Swing the valve away from the unit in order to get access to the front of the valve and regulator. Be careful not to damage gas lines or wires.

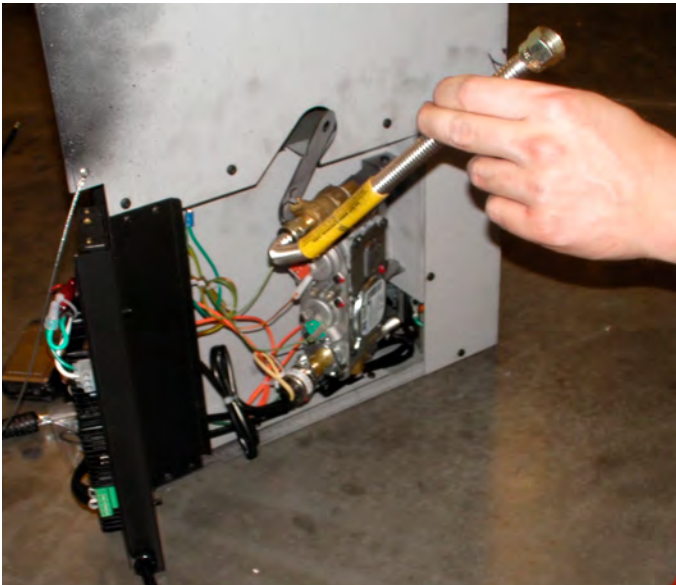

Figure 3 Sec.6

3). Using a T20 Torx screw driver, remove the 2 screws that attach the stepper motor to the valve.

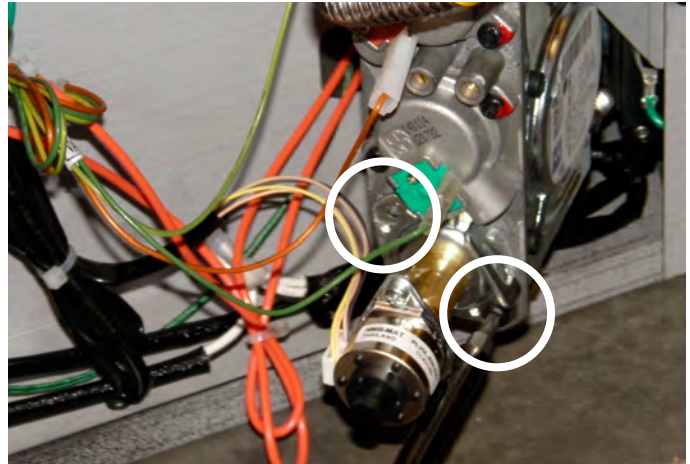

Figure 4 Sec.6

4). Remove the screws, stepper motor and rubber diaphragm.

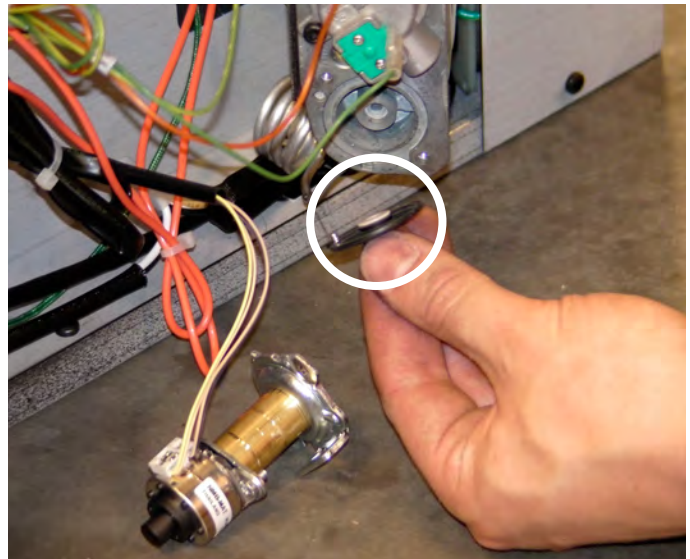

Figure 5 Sec.6

5). Remove the top 2 screws that hold the control mounting bracket in place.

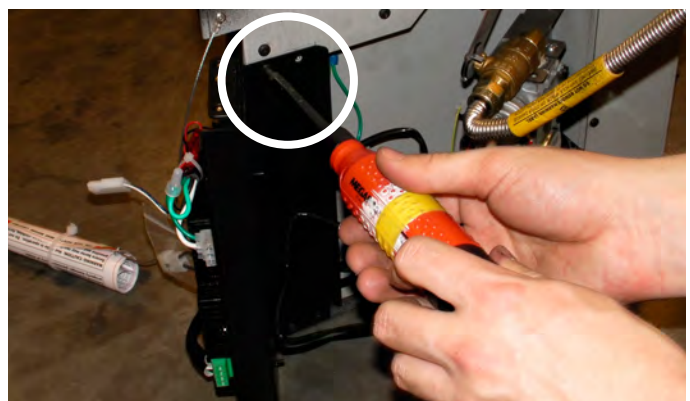

Figure 6 Sec.6

# Installation



6). Unplug the cable that runs from the stepper motor to the control board and remove it from in between the control board mounting bracket and the fireplace.

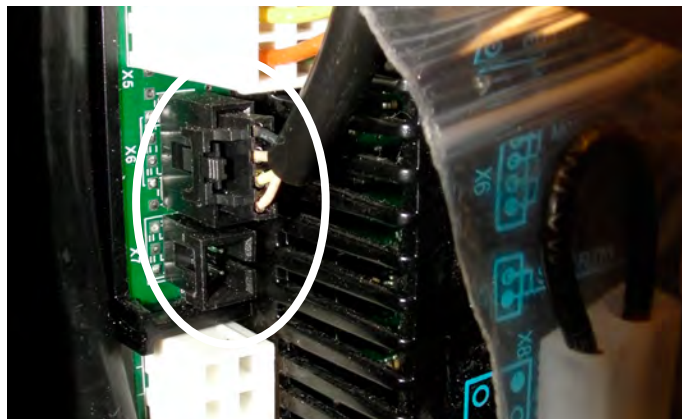

Figure 7 Sec.6

7). Place the LP stepper motor onto the valve being extremely careful that the orientation of the regulator is correct.

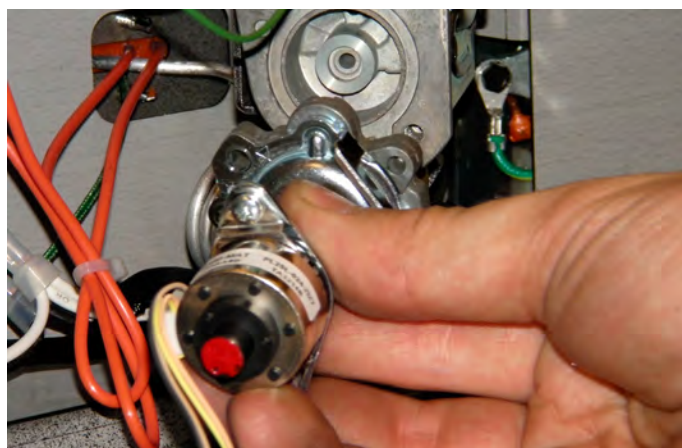

Figure 8 Sec.6

8). Reinstall the 2 screws supplied with the conversion kit to fasten the stepper motor to the valve body.



Figure 9 Sec.6

9). Attach the label provided to the side of the valve body. This label shows that the valve has been converted using SIT approved components.

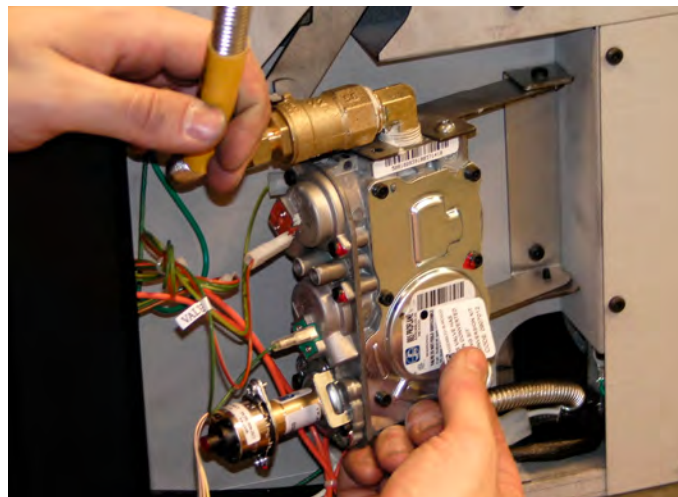

Figure 10 Sec.6

10). Run the cable from the stepper motor in between the control mounting bracket and fireplace.

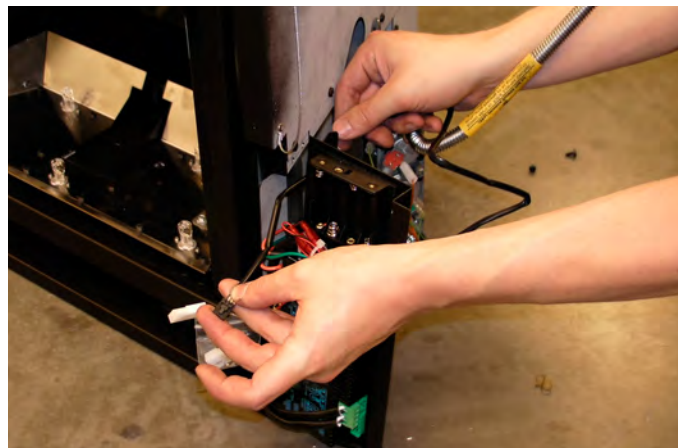

Figure 11 Sec.6

12). Plug the cable into the control board.



Figure 12 Sec.6



# Installation

13). Reinstall the 2 screws to secure the top of the control board mounting bracket. Using the zip strap supplied, secure the excess of wires neatly within the control / valve area. Re-install the 2 screws that keep the valve body from swinging out from the unit. **When swinging valve back in use care to not pinch or kink wires or pilot gas line. Inspect pilot gas line for leaks.**



Figure 13 Sec.6

## Converting the main burner orifice to LP

14). Remove burner, see burner removal section. Using a socket wrench and driver, loosen and remove the main burner orifice.



Figure 14 Sec.6

15). Place the LP main orifice into the end of the socket wrench. Being sure not to cross thread the orifice, install the orifice into the mounting within the air shutter box.



Figure 15 Sec.6

## Converting the pilot burner orifice to LP

16). Remove the spring clip that retains the Pilot Flame Hood.

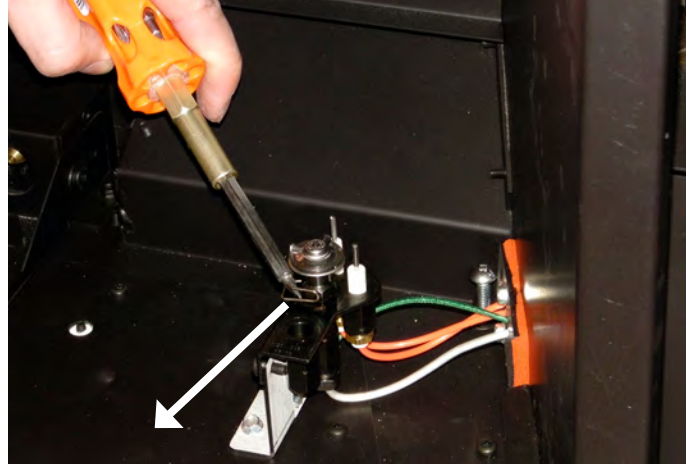

Figure 16 Sec.6

17). Remove the pilot hood from the pilot assembly

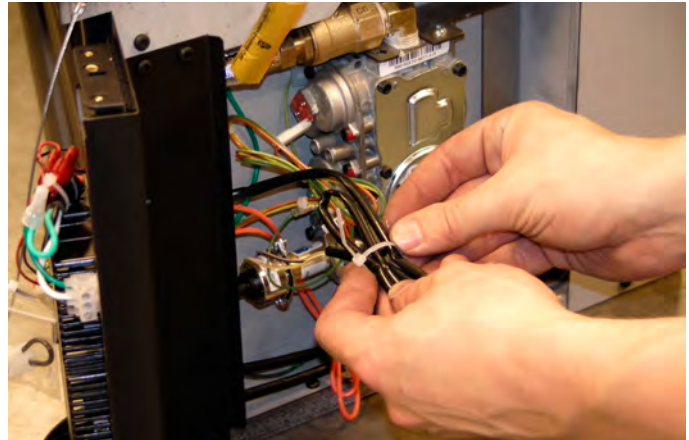

Figure 17 Sec.6

18). Using an Allen key, remove the NG Pilot Orifice

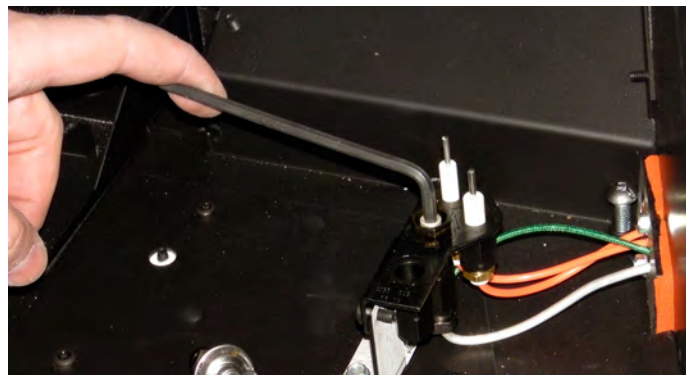

Figure 18 Sec.6

# Installation



19). Replace the NG Pilot orifice with the LP Pilot orifice. If you get the orifices mixed up, the LP orifice has a groove machined around the diameter near the end.

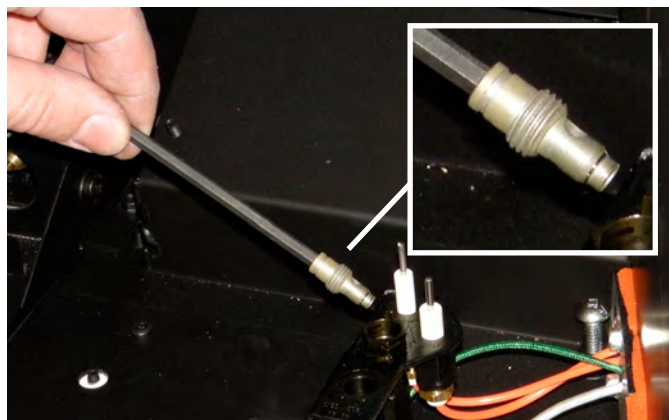

Figure 19 Sec.6

20). Reverse steps to install pilot hood.

21). The minimum primary air setting is different depending on fuel and burner. The minimum primary air is set by hand-bent tabs on the primary air adjustment. Bend the appropriate tab down for your fuel and burner. See specifications table or primary air adjustment for proper tab. See image below for tab lengths. If your setting is fully closed, bend both tabs up.

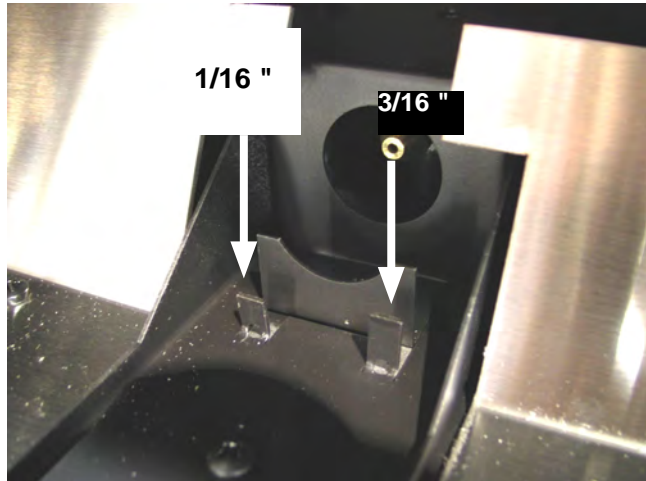

Figure 20 Sec.6

22). Connect the unit to the gas and electrical supply.

23). Before concluding the conversion, make sure you leak test the entire system and check all operational functions to ensure that the unit is performing safely and properly.

24). Fill out required information on LP conversion label.

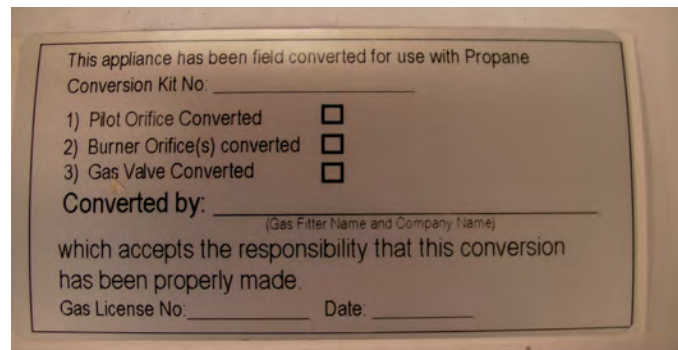

Figure 21 Sec.6

25). Remove rating plate from under appliance and turn it over to the blank side.



Figure 22 Sec.6

26). Apply sticker to blank side. Put rating plate back.



Figure 23 Sec.6



# Installation

## Gas line connection

The 30FID-S Insert is supplied with a flexible gas line that uses a ½" female flair to connect to your service. The flexible gas line is a one time connection. If you ever have to break the connection, you must replace the flexible gas line. There is also a safety shut-off valve that is built in and operated when needed using the door removal tool. Depending on your local gas codes, you may need to provide an additional gas shut off valve or even hard pipe the unit. In the event that you need to hard pipe the gas supply, a union will be required.

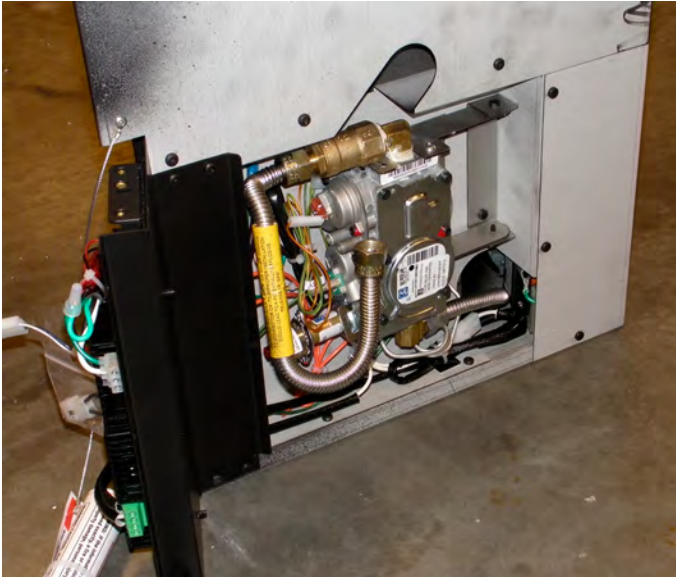

Figure 24 Sec.6



## WARNING

When installing the fireplace - gas lines, fittings, accessories or any other objects cannot impede the proper movement of the door buckles.

## Emergency Shut-off Valve

This appliance is equipped with a shut-off valve for use in case of emergency. It is located on top of the appliance gas valve and can be accessed and operated through the front of the fireplace using the door tool. The appliance is shipped from the manufacturer with the emergency shut-off valve in the closed position.



Figure 25 Sec.6 Inserting door tool through the front of the fireplace

Hook the door tool into the arm of the emergency shut-off valve. Pull the door tool towards you to open the valve and push it away from you to close the valve.

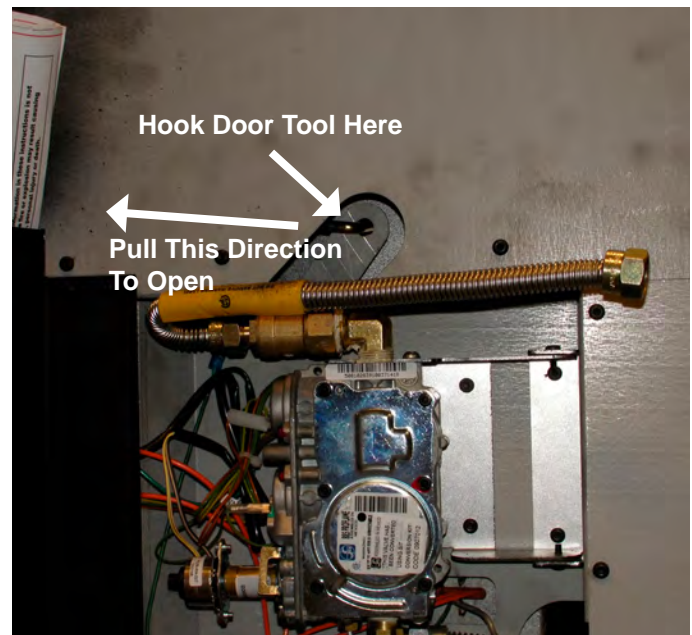

Figure 26 Sec.6 Emergency shut-off valve shown in closed position



# Installation



## Fuel Supply + Manifold Pressure Checking

It's imperative that you verify that the supply pressure to your appliance is adequate and that the valve is supplying the correct pressure to the pilot and main burner. The pilot burner operates at line pressure and may need further adjustment. The valve outlet pressure is set by the manufacturer of the valve but should be verified upon install. Follow the following steps to perform this system check. Inlet pressure must be checked with fireplace burning.

1). Remove the 2 screws from the Valve Mounting Bracket so that the valve can be swung away from the unit. The Shut off lever needs to be in the "off" position to be able to swing the valve out of the valve control box.

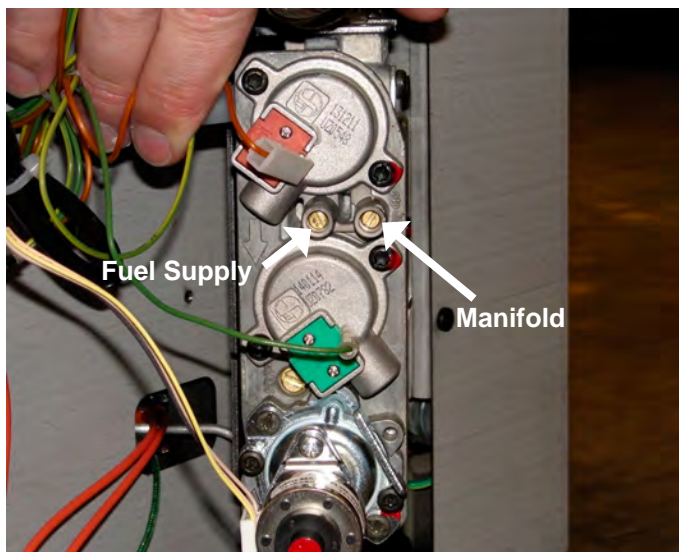

Figure 27 Sec.6

2) . Using a slotted screw driver, loosen the Manifold Tap on the valve front.

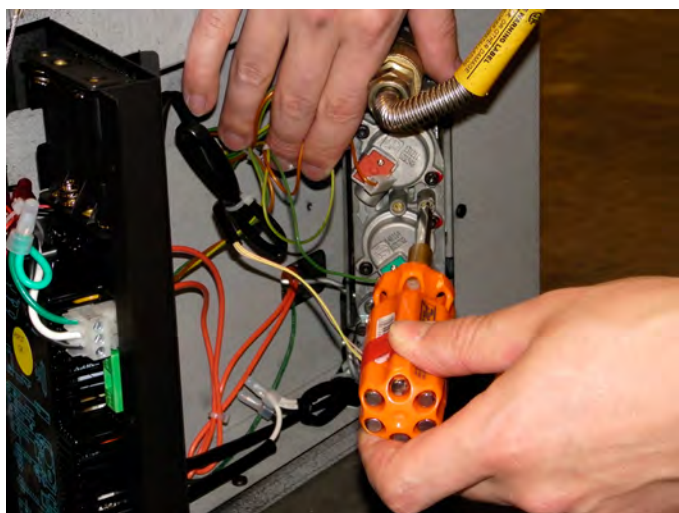

Figure 28 Sec.6

3). Attach a silicone hose to over top of the pressure tap on the valve face. Connect the hose to a manometer.



Figure 29 Sec.6 Shown on manifold top

4). The emergency shut-off valve needs to be placed in the "ON" position, see operation section for further information. The pressure tap on the left is to be used to measure supply line pressure. Refer to the specifications at the beginning of this manual for the gas pressure specs. Be sure to close and leak test all potential leak areas prior to closing in the install. Using the remote, turn the main burner on. Check the inlet pressure and the manifold pressure on high and low. Refer to specification sheet for acceptable values. Remove rubber tubes, close taps and check for leaks. Close emergency shut-off valve reinstall the valve mounting bracket. Make sure wires and pilot gas lines are not pinched or kinked. Check pilot gas line for leaks.



Figure 30 Sec.6



# Installation

## Faceplate Installation

### Standard Faceplate Offset Installation

When the standard faceplate is used the install width of the fireplace is 30 inches. If your install is smaller than 30 inches, you can use the offset kit, which will allow you to decrease the install size to 28 inches. This can only be done with the standard faceplate kit. You must install the offset kit on the standard faceplate before installing it on the appliance.



Figure 1 Sec.7 *Standard Faceplate Offset Kit Contents*

1). Unpack the standard faceplate kit. Take the rear faceplate and cut 0.325 inches away from the wire pass-through hole at the bottom right hand corner.



Figure 2 Sec.7 *Cutting away excess material*

2). Take the offset faceplate and peel the red protective plastic off of the self-adhesive tape.



Figure 3 Sec.7 *Peeling self-adhesive tape*

3). Place the rear panel from the standard faceplate over top of the offset trim. Press down on the adhesive to guarantee good adhesion.



Figure 4 Sec.7



Figure 5 Sec.7 *Offset Trim Installed on Rear Panel of Standard Faceplate*

4). Continue to **standard faceplate installation** section for remainder of installation.

# Installation



## Standard or Oversized Faceplate Installation

The Faceplate Surround includes two main parts: the Rear Panel and the Front Panel. The Rear Panel has a master override switch installed on the upper right corner. The Rear Panel must be installed prior to the Front Panel.

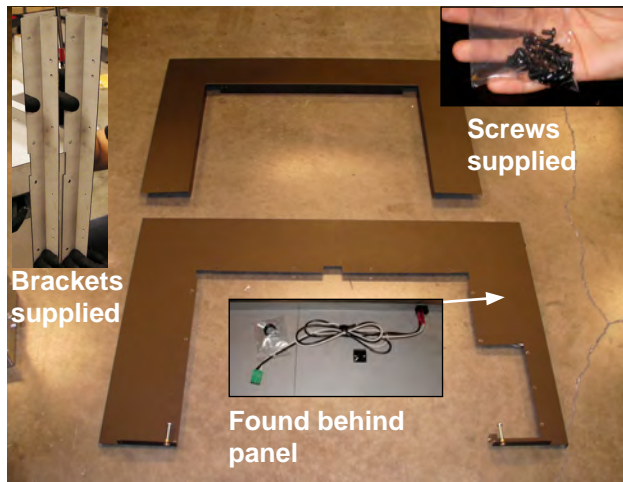

Figure 6 Sec.7 Standard or Oversized Faceplate Kit Contents

1). Remove the Lighting Instructions from the Control area and leave on the floor in front of the unit.

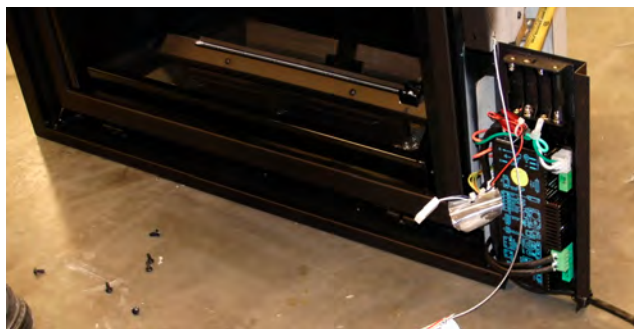

Figure 7 Sec.7

2). Install the Rear Faceplate Panel support brackets using screws provided (4 locations). Ensure proper orientation of the bracket.

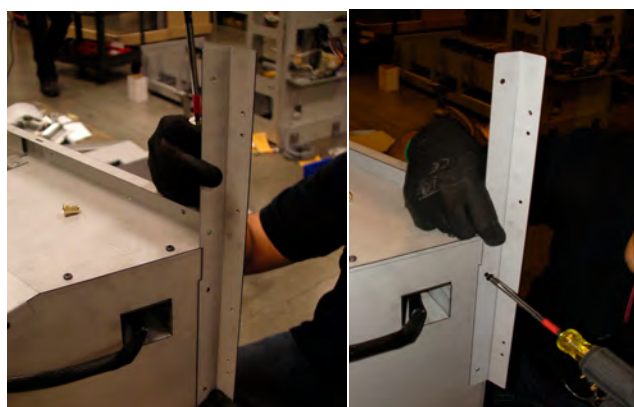

Figure 8 Sec.7



Figure 9 Sec.7

3) Align the Rear Faceplate with the front of the fireplace.



Figure 10 Sec.7 The Rear Faceplate Panel

4) . Temporarily place the Electrical Cord through the hole in the right side of the Rear Faceplate.

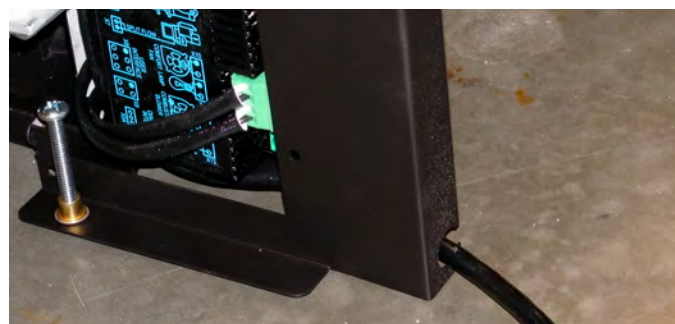

Figure 11 Sec.7



# Installation

5) Attach the Rear Faceplate to the Firebox using the screws provided (18 locations). Do not insert screws in magnet locations highlighted in Figure 13 below.



Figure 12 Sec.7

6) Install the four Front Faceplate Retainer Magnets using screws provided as shown (8 locations). Note proper orientation of magnets.



Figure 13 Sec.7

6) Remove the twist tie and Zip Strap that is on the On / Off Switch wire harness.



Figure 14 Sec.7

7) Slip the Split Plastic Grommet, found in the plastic bag attached to the master override switch, around the Power Cable and then press it into the provision on the right lower side of the Rear Faceplate to secure the Power Cord.



Figure 15 Sec.7

8) Thread the On/Off Wire Harness through the gap between the Control Board Mounting Bracket and the Rear Faceplate Panel.

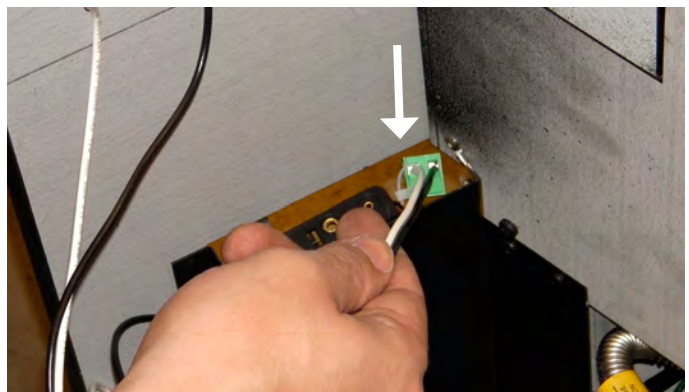

Figure 16 Sec.7

# Installation



9) Connect the Plug to the appropriate terminal on the Control Panel.

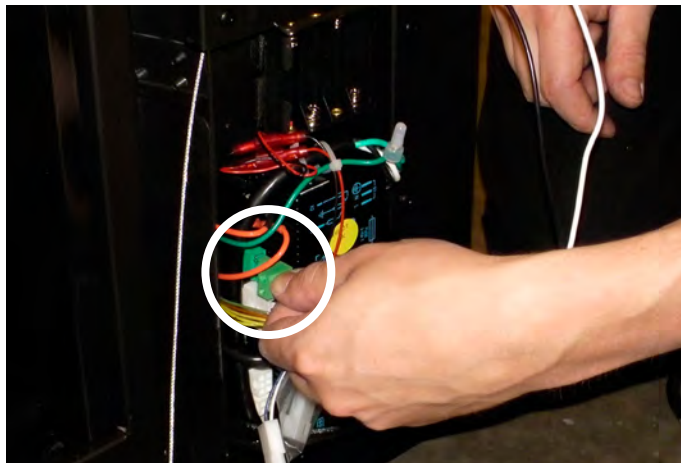

Figure 18 Sec.7

10) Place the Zip Strap through the hole in the Plastic Stick-on Retainer on the back of the Rear Faceplate. Zip the wires together in one tidy package as shown.

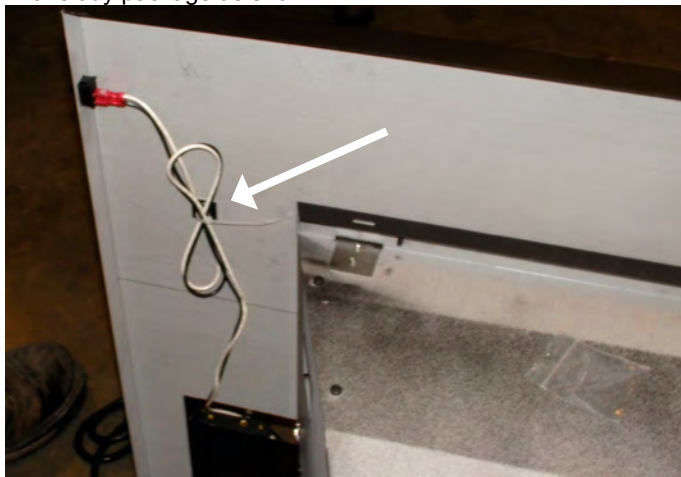

Figure 19 Sec.7

11) Place the master override switch in the OFF position. Until the remote is synced to the control board, this switch acts as a master. If you apply gas and power to the unit while this switch is in the ON position, it will initiate lighting.



Figure 20 Sec.7

12) At this stage it is easiest to install the batteries. See section 8 on battery installation and replacement.

13) Install the Front Trim. It has two hooks at the bottom which must be engaged in the bottom right and left of the Front Faceplate. Magnets hold it at the top right and left.

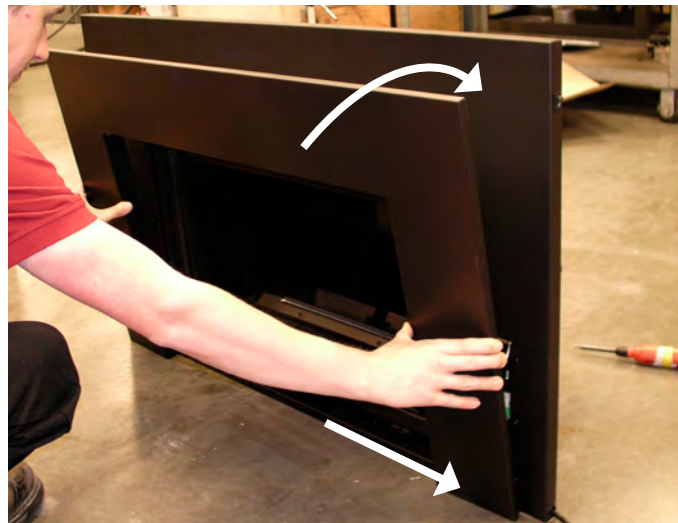

Figure 21 Sec.7

14) Hooks are used to secure the Front Faceplate at the bottom left and right.



Figure 17 Sec.7 (unpainted shown for illustration)

15) Trim installation completed.



Figure 22 Sec.7



# Installation

## Four Sided Faceplate Installation

The Faceplate Surround has two main parts: the Rear Panel and the Front Panel. The Rear Panel has a master override switch installed on the upper right corner. The Rear Panel must be installed prior to the Front Panel.

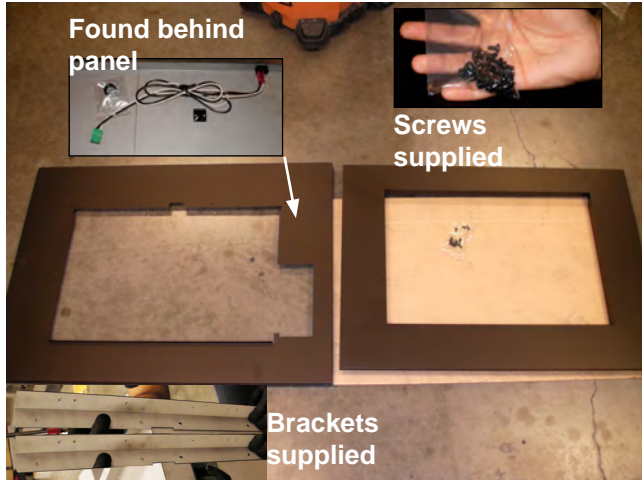

Figure 23 Sec.7 Four Sided Faceplate Kit Contents

1) Remove the Lighting Instructions from the Control area and leave on the floor in front of the unit.

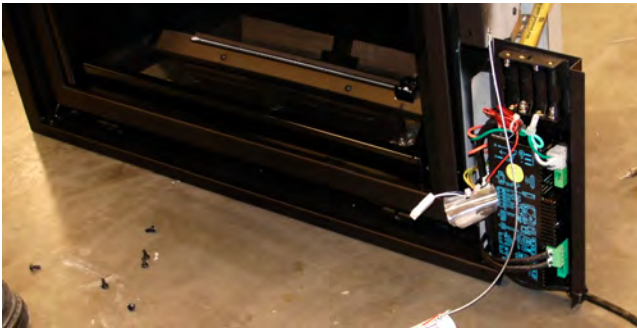

Figure 24 Sec.7

2) Install the Rear Faceplate Panel support brackets using screws provided (4 locations). Ensure proper orientation of the bracket.

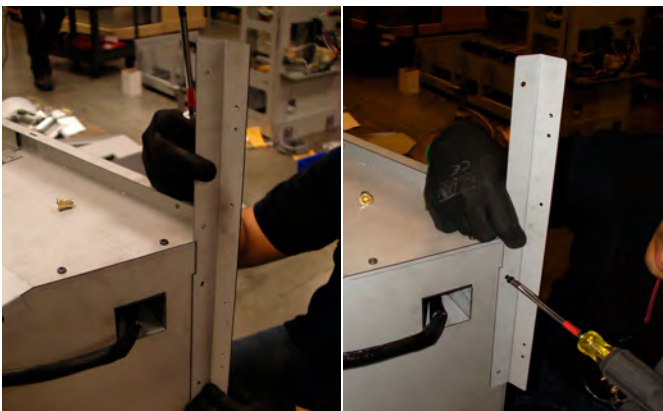

Figure 25 Sec.7



Figure 26 Sec.7

3) Hold the Rear Faceplate in place.



Figure 27 Sec.7

4) Temporarily, place the Electrical Cord through the hole in the bottom right corner of the Rear Faceplate

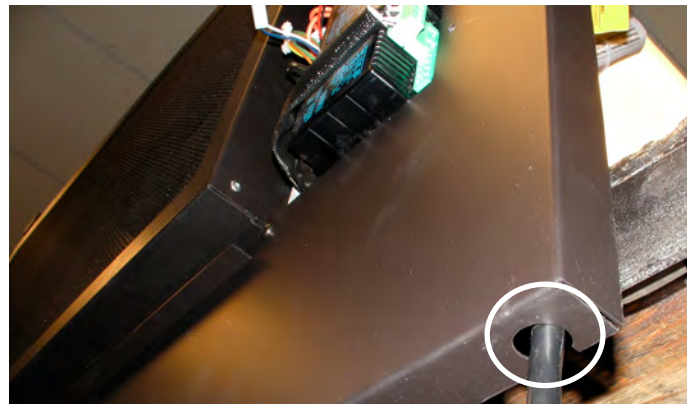

Figure 28 Sec.7

# Installation



5). Attach the Rear Faceplate to the Firebox using the screws provided (18 locations). Do not insert screws in magnet locations highlighted in Figure 30 below.



Figure 29 Sec.7

6) Install the four Front Faceplate Retainer Magnets using screws provided as shown (8 locations). Note proper orientation of magnets.

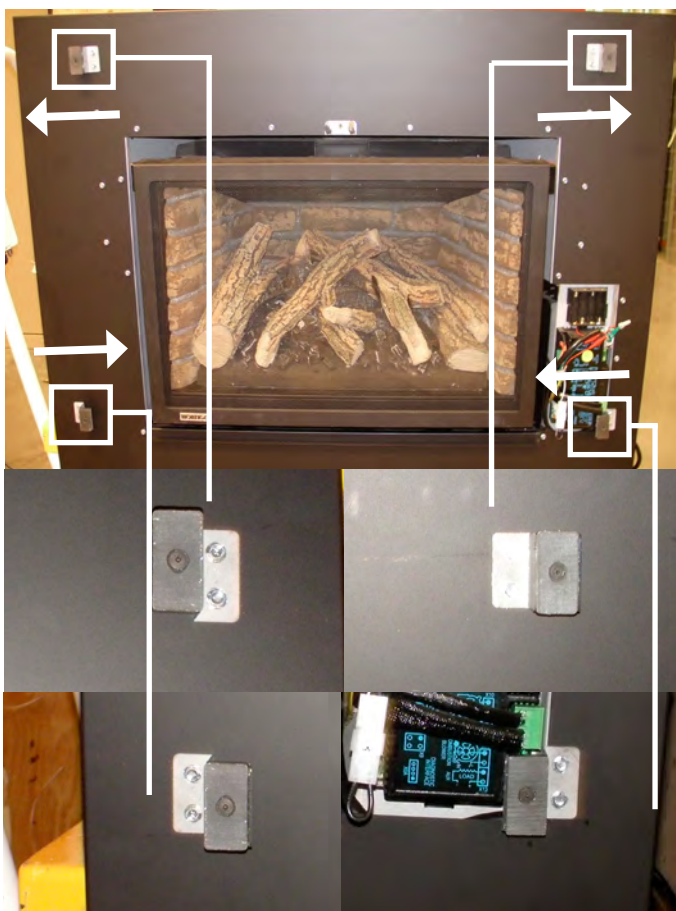

Figure 30 Sec.7

6). Remove the twist tie and Zip Strap that is on the On / Off Switch wire harness.

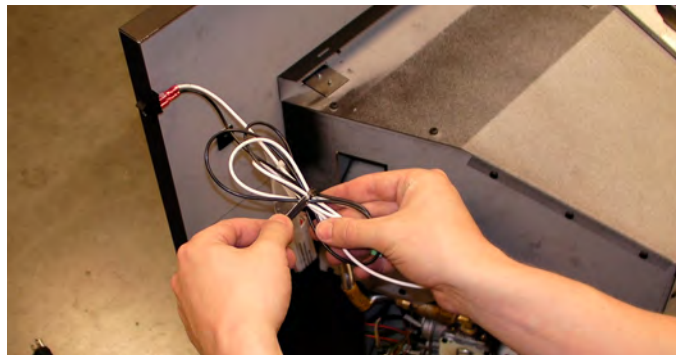

Figure 31 Sec.7

7). Slip the Split Plastic Grommet, found in the plastic bag attached to the master override switch, around the Power Cable and then press it into the provision on the right lower side of the Rear Faceplate to secure the Power Cord.



Figure 32 Sec.7

8). Thread the On/Off Wire Harness through the gap between the Control Board Mounting Bracket and the Rear Faceplate Panel.

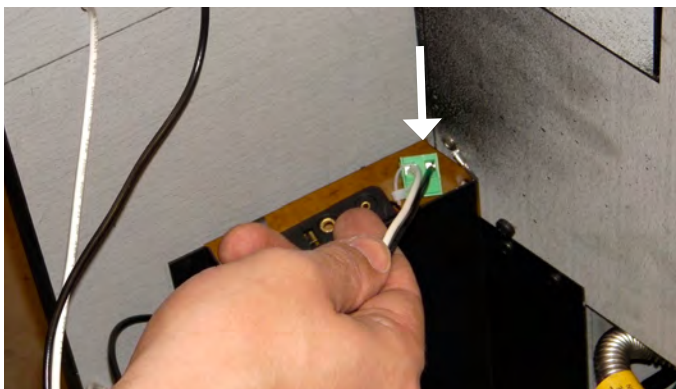

Figure 33 Sec.7



# Installation

9) Connect the Plug to the appropriate terminal on the Control Panel.



Figure 34 Sec.7

10). Place the Zip Strap through the hole in the Plastic Stick-on Retainer on the back of the Rear Faceplate. Zip the wires together in one tidy package as shown.

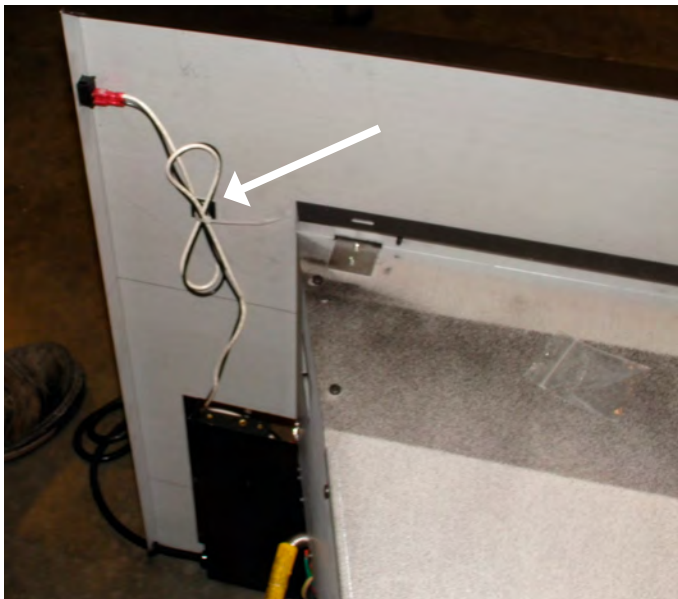

Figure 35 Sec.7

11). Place the master override switch in the OFF position. Until the remote is synced to the control board, this switch acts as a master. If you apply gas and power to the unit while this switch is in the ON position, it will initiate lighting.



Figure 36 Sec.7

12). At this stage it is easiest to install the batteries. See section 8 on battery installation and replacement.

13). Install the Front trim. It has two hooks at the bottom which must be engaged on the bottom right and left of the Front Faceplate (see Figure 38 Sec.7). Magnets hold it at the top right and left.



Figure 37 Sec.7

14) Hooks to secure the Front Faceplate are at the bottom left and right.

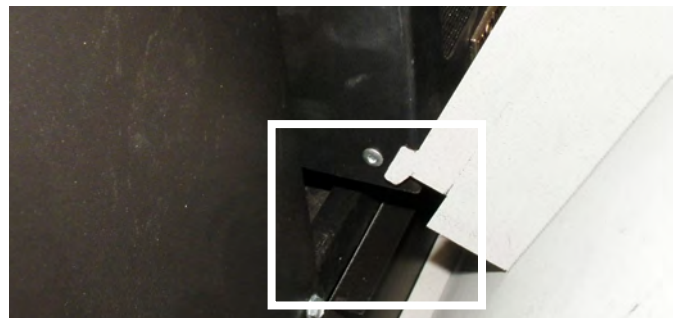

Figure 38 Sec.7 (Unpainted shown for illustration)

15). Trim installation completed.



Figure 39 Sec.7



# Installation



## CPI [Continuous Pilot Ignition] / IPI [Intermittent Pilot Ignition] Jumper Cable Installation

### “Why use CPI mode?”

There are several reasons why you may choose to use CPI mode. When a flue is cold it can be difficult to light the appliance. It can take a bit of time (particularly on tall vents) to initialize vent action. This can result in “lifting” or “ghosting” of the flames during the first two to three minutes of operation. It is also possible to encounter times when the fireplace fails to light successfully. The fireplace will then attempt to re-light a second or third time depending on prevailing temperatures or altitude. When in CPI mode the pilot also keeps the system warm. During a “cold” start, condensation will normally form on the inner glass surface of the door. This condensation will quickly dry, however, the condensation tends to run down the glass and cause some streaking. CPI mode helps to resolve this issue. If CPI mode is used during the winter months the energy it takes to run the pilot is partially recovered as heat into the building, so it does not waste as much energy as running a pilot in the off season.

A connector is supplied with this unit that can be plugged into the controller. This Jumper Cable gives the Remote Control the ability to operate the CPI / IPI switch and set the unit to operate in either condition. CPI means “Continuous Pilot Ignition” or “Standing Pilot” as it is commonly known. IPI means “Intermittent Pilot Ignition”, which only initializes the pilot when you are going to be using the appliance.

### The difference between IPI and CPI:

**IPI (Intermittent Pilot Ignition) Mode:** is a fuel saving mode in which the pilot is only used when the main burner is on.

**CPI (Continuous Pilot Ignition) Mode:** The Pilot runs continuously even when the main burner is off.

## Installing the CPI Jumper Cable

1). Remove the Face Plate Front panel.



Figure 1 Sec.8

2). Remove the bag containing the Jumper Cable from the plastic bag as shown. Remove the plastic bag from the unit.

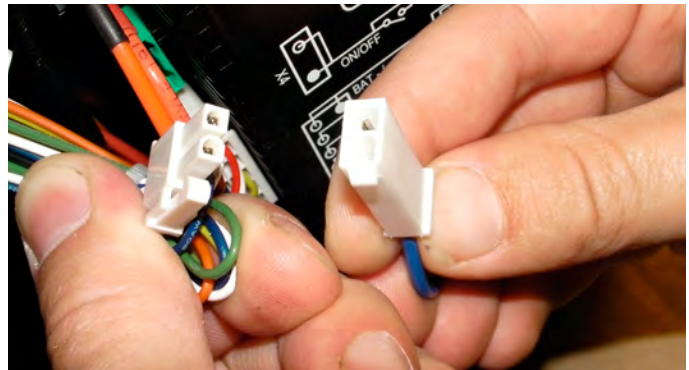

Figure 2 Sec.8

3). Find the corresponding plug attached to the control wire harness.



Figure 3 Sec.8

4). Pack the Cable and Plug back around the control set and re-install the Faceplate Front.

5). See operations section to turn remote into CPI mode.



# Installation

## Leveling the Unit

This unit has 4 leveling screws, 2 located inside the rear of the firebox and 2 located at the bottom front of the Rear Faceplate. Once the unit is in position, you can use a Phillips screw driver or Slotted screw drivers to adjust each leveling screw as required.

- 1). Remove burner, see section on burner removal and install
- 2). Rear leveling screw adjustment (Linear burner version shown)



Figure 4 Sec.8

- 3). Front leveling Screw adjustment (Linear burner version shown)



Figure 5 Sec.8

- 4). Reinstall the burner.

## Connecting Power

Please refer to the specification for power supply requirements. This appliance is supplied with a Power Cord located on the right side of the appliance. It can be connected directly to a standard electrical outlet.

### WARNING

#### Electrical Grounding Instructions

This appliance is equipped with a three-prong (grounding) plug for your protection against shock hazard and should be plugged directly into a properly grounded three-prong receptacle. Do not cut or remove the grounding prong from this plug.

## Battery Installation / Replacement

The 30FID-S uses 2 different sets of Batteries. The Control Backup uses 4x AA batteries to continue operations during power outages. The Remote Control uses 3x AAA Batteries for general operation. The Control Backup Batteries should be changed on a regular basis regardless of if they have been used or not so that in the event of a power failure, you will continue to have an operational heating appliance. To replace the Controller Backup Batteries, remove the Front Faceplate and remove and re-install new batteries into the Battery Holder located just above the main Control Board.



Figure 6 Sec.8



Figure 7 Sec.8

# Installation



## Brick Panel Installation

The 30FID-S must only be used with the Firebox Panels installed. With the Fireplace Door removed, the panels can be easily installed.

1). Make sure all the Brick Panels are received in good order



Figure 1 Sec.9

2). Slide the side panel along the wall of the Firebox towards the back of the Firebox. There is a retainer clip at the top and at the bottom of the Firebox. These Firebox Panels will slide within them. Leave enough room to slide the rear panel behind the side panel.



Figure 2 Sec.9

3). Place the Rear Brick Panel behind the Right Panel. This panel can be installed upside down, so make certain that the grout lines line up with the side panel, make sure grout line is at the top of the rear panel. Push right side panel back until it hits the rear panel. Adjust right panel so brick and grout lines line up.



Figure 3 Sec.9

4). Install the Left Brick Panel along the left side of the Firebox.



Figure 4 Sec.9

5). Push top retainer in tighter if needed.

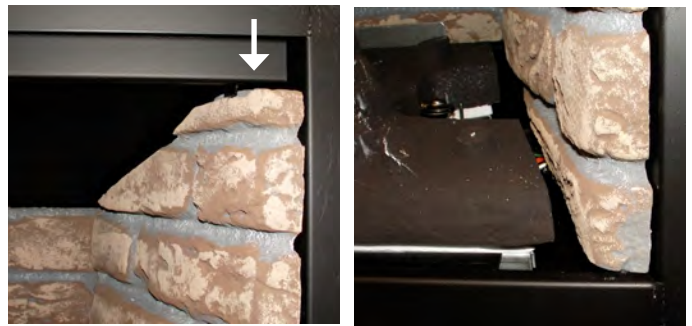

Figure 5 Sec.9 Retainer detail Top and Bottom



Figure 6 Sec.9 Completed brick installation



# Installation

## Porcelain Panel Installation

The 30FID-S must only be used with the Firebox Panels installed. With the Fireplace Door removed, the panels can be easily installed.

1). Make sure all the Porcelain Panels and fasteners are received in good order.



Figure 7 Sec.9



Figure 8 Sec.9

2). The back of the porcelain panels have insulation. Make sure insulation is in good order. Without insulation you may experience pilot stability issues.

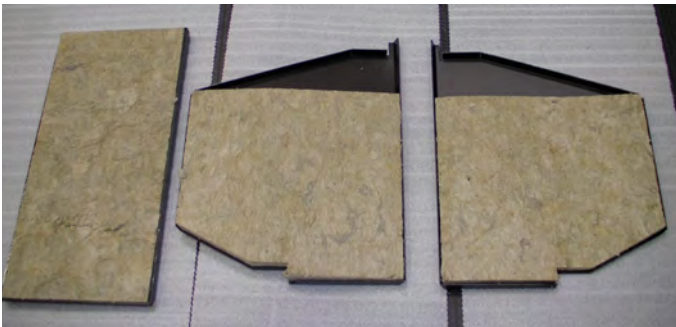

Figure 9 Sec.9

3). The porcelain panel kit comes with replacement panel retainers. Use if necessary. See **figure 13** for panel retainer location.

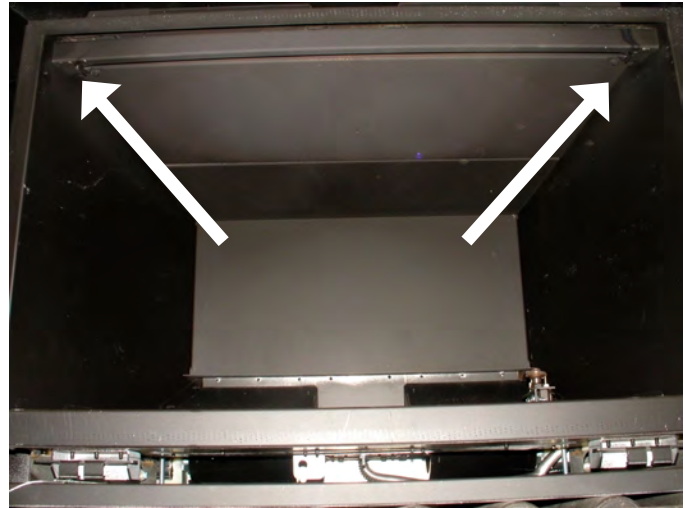

Figure 10 Sec.9

5). Carefully slide the right panel along the right side of the firebox leaving enough room to slide the rear panel behind it. Take care to not scratch the firebox paint.

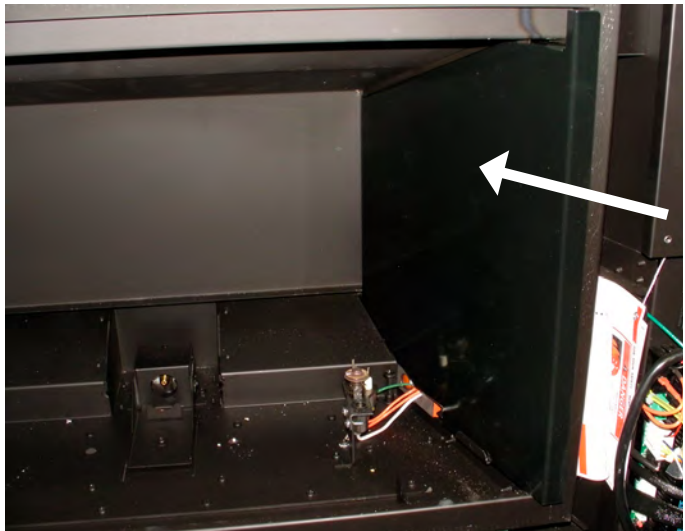

Figure 11 Sec.9

# Installation



6). Slide the rear panel behind the right panel and push the right panel back holding the rear panel in place.

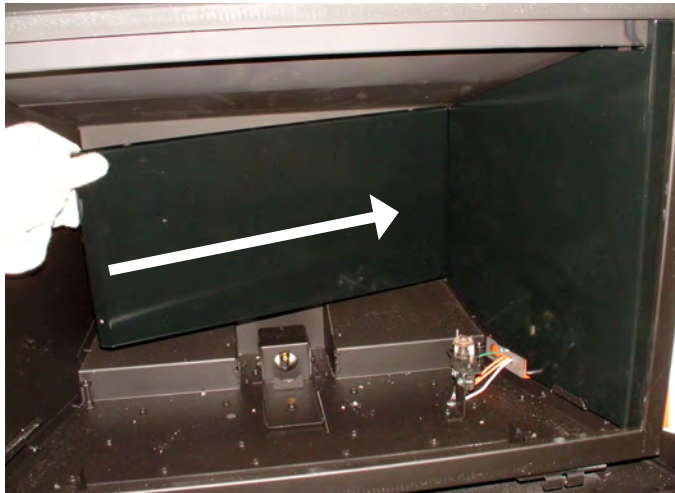

Figure 12 Sec.9

9). If needed, push the top panel retainers in with a screw driver to keep the panels tight against the firebox.

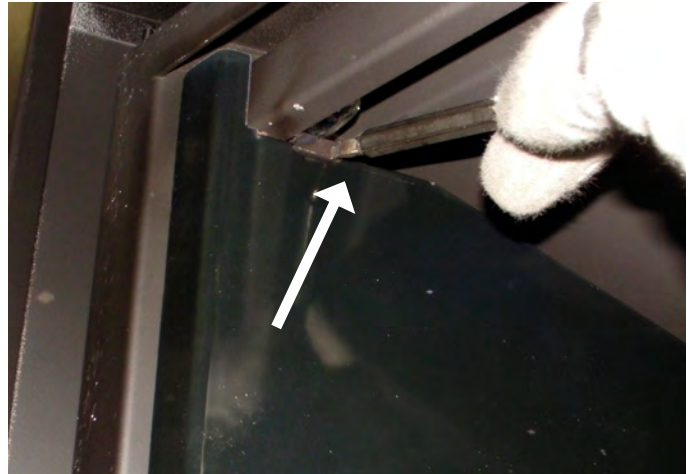

Figure 15 Sec.9

7). There is a securing hole in the bottom of the side panels. Using one of the supplied screws, secure the side panel to the bottom panel retainer. You may need to push the panel back into the firebox to get the holes to line up.

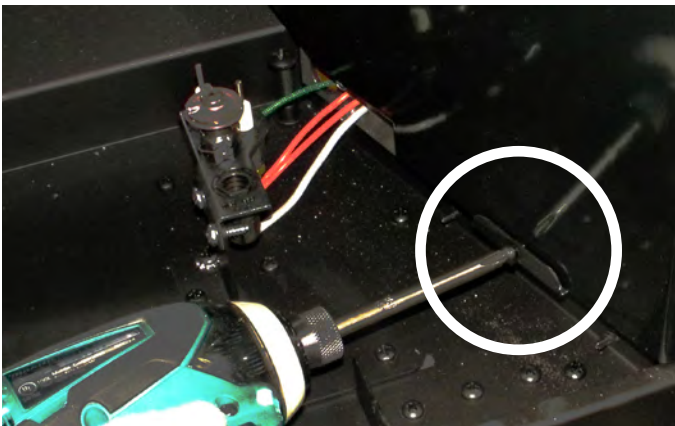

Figure 13 Sec.9

8). Slide the left panel into the firebox until it touches the rear panel. Secure with the supplied screw into the bottom panel retainer.

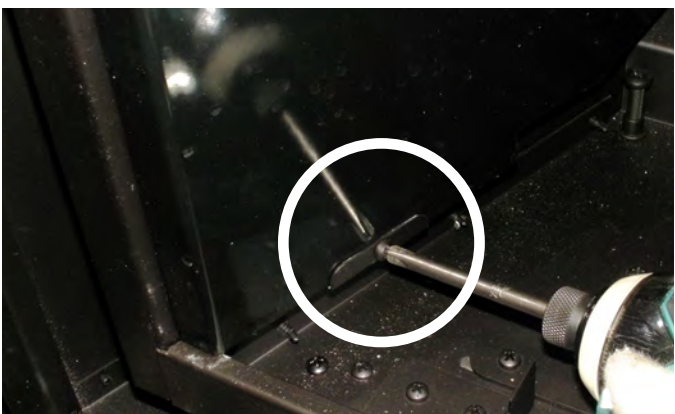

Figure 14 Sec.9



# Installation

## Log Installation

The 30FID-S uses cast ceramic logs for exceptionally high definition and realism. The ceramic is fragile and it can be easy to scuff or chip the logs. The inside of the logs are purple so you want to take care to not damage them. Each log has specific locating details such as pins, posts or embers to line up with. Follow the images provided to ensure proper operation and flame pattern.

- 1). Inspect the logs as received for any shipping or handling damage.



Figure 16 Sec.9

- 2). Place black ceramic air baffle on the left side of the firebox. The profile of the burner continues on the ceramic log baffle.



Figure 17 Sec.9 Burner as shipped



Figure 18 Sec.9 Ceramic baffle installation

- 3). Place first log on top of the ceramic pin, see **Figure 19**. Pull first log forward so that it bumps up against the ceramic embers and the ceramic air baffle, see **Figure 20**.



Figure 19 Sec.9 Log 2 installation

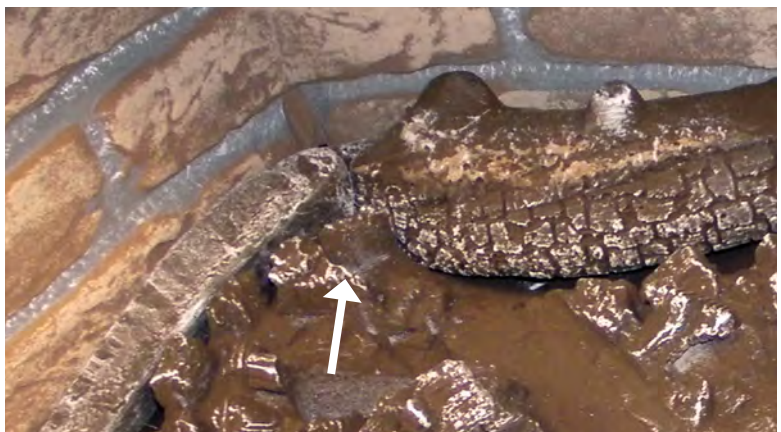

Figure 20 Sec.9 Log 2 installation

# Installation



4). Place the second log on top of the first log ceramic pin and fit the front end of the log into the cradle of the ceramic burner, see **Figure 21**.

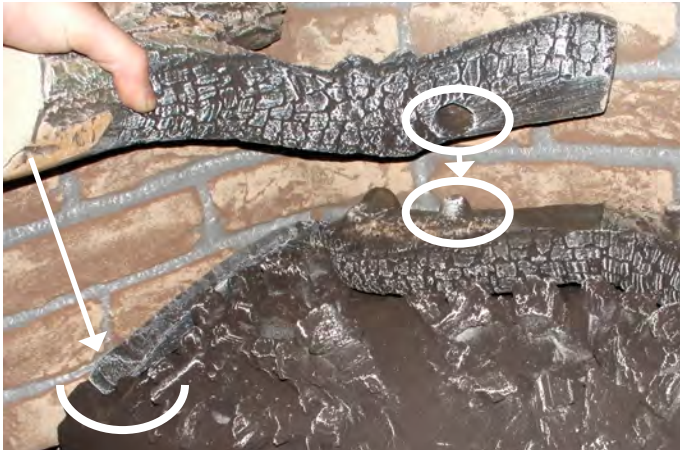

Figure 21 Sec.9 Log 2 installation

5). Place the third log on the ceramic burner. The ember part of the log locates on an ember on the burner. The front of the log locates to a groove in the burner, see **Figure 22-24**.



Figure 22 Sec.9 Log 3 installation



Figure 23 Sec.9 Log 3 installation details

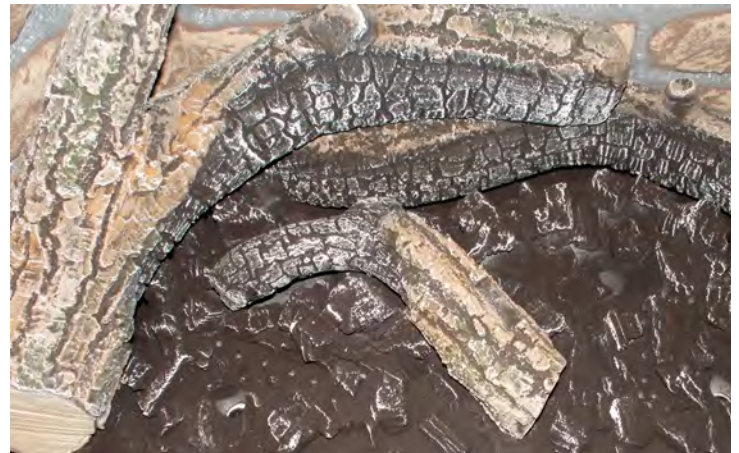

Figure 24 Sec.9 Log 3 installation details



# Installation

6). Place the fourth log on top of the third log. The ember part of the fourth log locates on a 'V' shaped bump on the burner, see **Figure 25**.



Figure 25 Sec.9 Log 4 installation



7). Place the fifth log on top of the first log. The first log has a ceramic pin to locate the fifth log, see **Figure 26**.

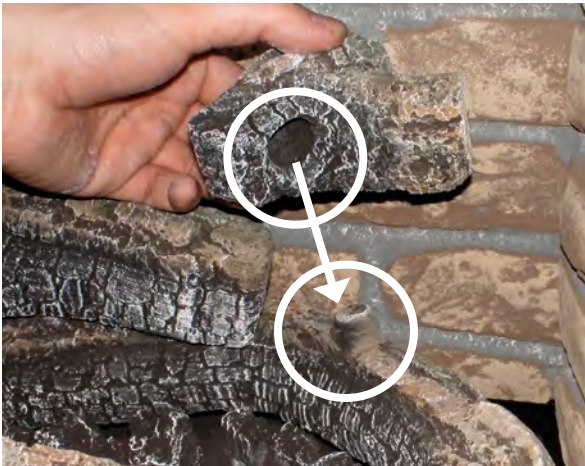

Figure 26 Sec.9 Log 5 installation details



Figure 27 Sec.9 Log 5 installation

8). Place the sixth log on top of the fifth and first log. The curve in the sixth log meets up with a locator on the first log. The fifth log has a groove in it. Line up the front and sixth log with this groove, see **Figure 28**.

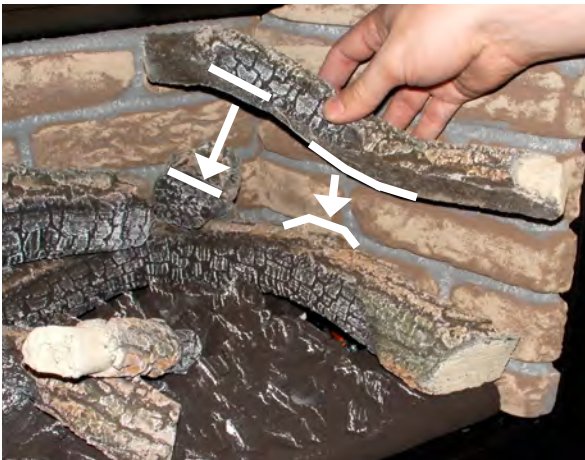

Figure 28 Sec.9 Log 6 installation details



Figure 29 Sec.9 Log 6 installation



# Installation



9). Place the split end of the 'Y' shaped seventh log on the ceramic burner and place the top end on the second log. Place the other end on the 'Y' on the sixth log, see **Figure 30**.



Figure 30 Sec.9 Log 7 installation details



Figure 31 Sec.9 Log 7 installation

10). Place the end of the eighth log in the ceramic burner. The cross the eighth log across the seventh log, see **Figure 32**.



Figure 32 Sec.9 Log 8 installation detail



Figure 33 Sec.9 Completed Log Installation



# Operation

## Operation

### Initial Operation

Your installation and setup is nearly complete. The first fire will result in some smoke and smell being emitted from the appliance. During the manufacturing of the product, paint, sealant and other materials are used, and when the unit is fired for the first time, the temperature will cure these materials. When you fire this unit for the first time, make certain that you've opened windows or use any other ventilation to keep these fumes from building up. Once at full operating temperature this will subside and then stop.

Your fireplace comes with decorative ceramic burner, log set and panel set. These items off gas as part of their curing process. This off gas can sometimes cause initial deposits on the glass. The glass may need to be cleaned after the first few hours of operation. See door removal and glass cleaning section.

### Pilot Flame Adjustment

Pilot height is factory set when inlet is 7" WC. Adjustment may be required if installation is not 7" WC. Refer to pilot flame height drawing, **Figure 3**. The pilot flame runs directly at line pressure. Variances in supply pressure can affect the size of the pilot flame. Excessive pilot size can overheat the flame proving components. Under-sized pilot flames will result in problems initializing or maintaining the pilot flame or main burner flame, or not carrying over to the main burner as intended. The pilot flame adjustment is on the front of the valve. You need to turn on the fireplace and then using remote control, turn down the flame height until the main burner goes out, leaving only the pilot flame on. If you reduce the pilot flame too much, the unit will go out and then try to re-lite automatically.

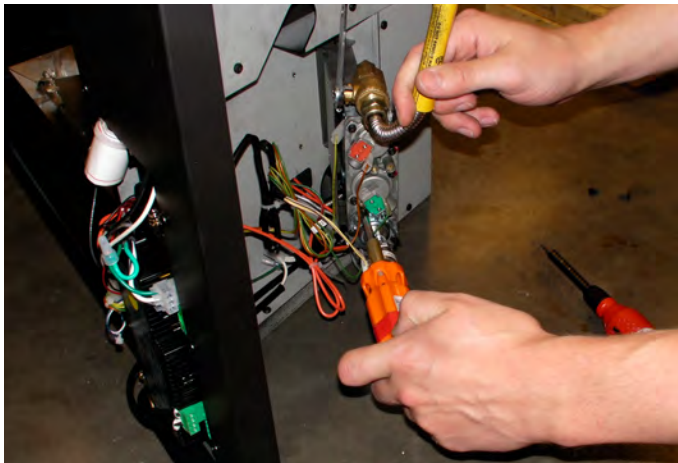

Figure 1 Sec.10 *Valve is swung away from the unit*

Pilot adjustment is made with a flat screw driver turning it in (clockwise) reduces the pilot flame size. Turning it out, (counter clockwise) will increase the flame size. If the pilot is too high the flame at the back right of burner can look too tall.



Figure 2 Sec.10

If the pilot flame is turned down too much, the flame will lift off the sensor and shut the unit off. The flame should be adjusted until it is not excessively large, but is large enough to operate the unit in a reliable fashion.

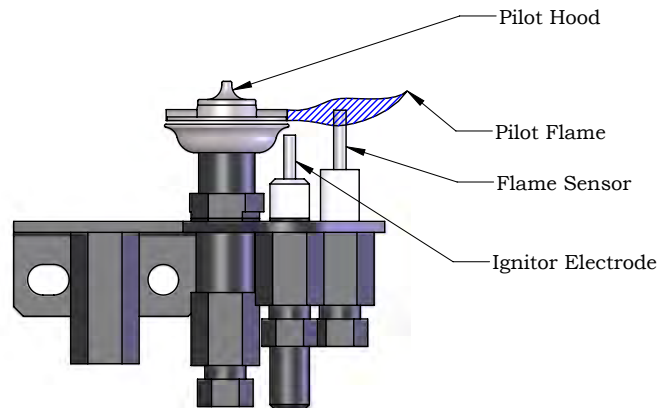

Figure 3 Sec.10 *Showing the approximate size of a pilot flame*

# Operation



## Master Override Switch

The on/off switch is located on the top right hand side of the Rear Faceplate.

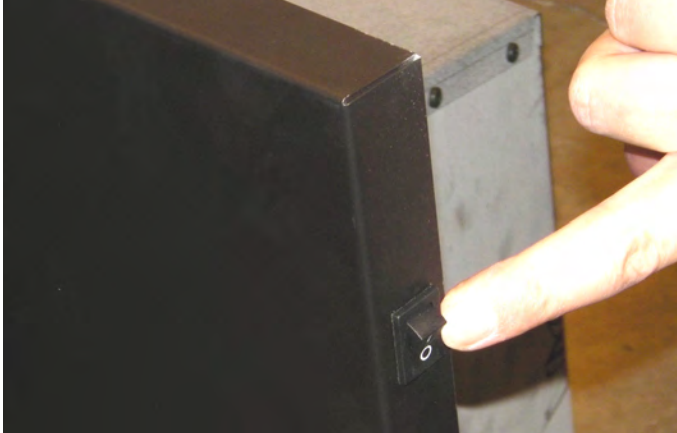

Figure 4 Sec.10

This switch is the master override switch. If it is in the off position the remote can not turn on the fireplace.



# Operation

**FOR YOUR SAFETY - READ BEFORE LIGHTING:**

**! DANGER**



**HOT GLASS WILL CAUSE BURNS. DO NOT TOUCH GLASS UNTIL COOLED.**

**NEVER ALLOW CHILDREN TO TOUCH GLASS.**

A barrier designed to reduce the risk of burns from the hot viewing glass is provided with this appliance and shall be installed for the protection of children and other at-risk individuals.

**WARNING: If the information in these instructions is not followed exactly, a fire or explosion may result causing property damage, personal injury or death.**

**WARNING/ CAUTION: Hot while in operation. Do not touch. Severe burns may result. Keep children, clothing, furniture, gasoline and other liquids having flammable vapours away.**

**See installation and operating instructions accompanying this appliance for more information.**

- A. This appliance is equipped with an ignition system that lights the pilot burner automatically. **Do not attempt to light the pilot by hand.**
- B. **BEFORE LIGHTING** smell all around the appliance area for gas. Be sure to smell next to the floor because some gas is heavier than air and will settle on the floor.
 

**What To Do If You Smell Gas:**

  - Do not try to light any appliance.
  - Do not touch any electrical switch; do not use any phone in your building.
- C. Use only your hand to operate gas control. Never use tools. If the control does not function, don't try to repair it, call a qualified service technician. Force or attempt to repair may result in a fire or explosion.
- D. Do not use this appliance if any part has been under water. Immediately call a qualified service technician to inspect the appliance and to replace any part of the control system, and any gas control which has been under water.

**LIGHTING INSTRUCTIONS:**

1. **STOP!** Read the safety information above on this label.
2. Turn "ON" manual "ON/OFF" switch. (If available)
3. Turn Incoming gas shut off valve to the "ON" position.
4. Wait 5 minutes to clear out any gas. If you smell gas, **STOP!** Follow "B" in the safety information above on this label. If you don't smell gas, go to the next step.
5. Turn fireplace "ON" using wall switch or remote control.
6. If the Fireplace does not light, the System will cycle through two trials, (one minute audible clicking, thirty seconds of silence, and then another one minute of audible clicking). If the system locks out due to inadequate gas flow, refer to "Troubleshooting" in instruction guide.
7. After completion of the information in the Troubleshooting section, Repeat step 5.
8. If the system will not function correctly, follow the instructions "To Turn Off Gas To Appliance" and call your service technician or gas supplier.

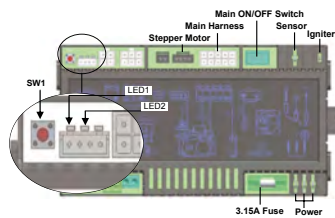

SW1 = Programming Button  
 LED1 = Red Diagnostic Light  
 LED2 = Amber Programming Remote Control Light  
 Typical Control Module shown

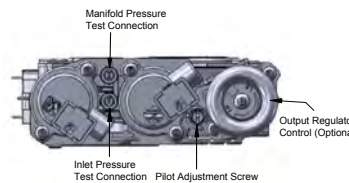

Gas Valve

**TO TURN OFF GAS TO APPLIANCE:**

1. Turn off fireplace using wall switch or remote control.
2. Turn the incoming gas shut off valve to "Off".

P/N LB1176-000614

# Operation



## Aeration Adjustment

All gas fireplaces mix a certain amount of air with the fuel prior to combustion. This is known as an "Aeration" setting. This is adjustable and needs to be set based on various factors such as:

- 1). Type of fuel
- 2). Altitude of installation
- 3). Type of burner
- 4). Home owners preference to blue or yellow flames.

The 30FID-S has an externally adjustable aeration setting, which means it can be adjusted during operation the minimum air aeration setting is factory set, but may need adjustment in the field. Fireplaces need a fair amount of time to get up to temperature, approximately 45 minutes. Aeration settings should only be made when the unit is at full operating temperature.

The aeration setting lever can be accessed using the Door Tool that comes with the unit. The aeration setting lever is located underneath the firebox, about half way into the unit. The lever pulled forwards increases the aeration setting and push rearward decreases the aeration setting. The ideal setting will result in a flame that is about 2/3 blue and 1/3 yellow. If you have a burner that is sooting or have soot deposits on your logs or glass, the aeration setting is too small and needs to be set larger.

## Minimum Aeration Setting

NG - 1/16" Open

LP- 1/16" Open

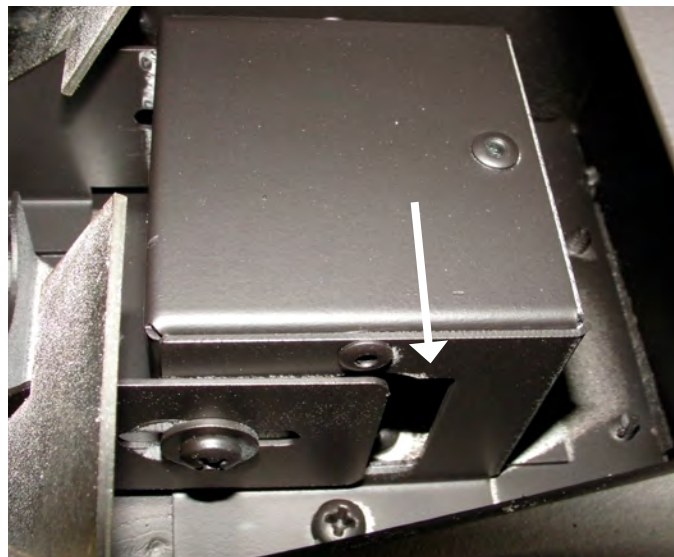

Figure 7 Sec.10 Aeration adjustment opening



Figure 5 Sec.10 *Using the door tool to operate the aeration setting.*

Engage the door tool into the keyhole in the Aeration Setting Lever

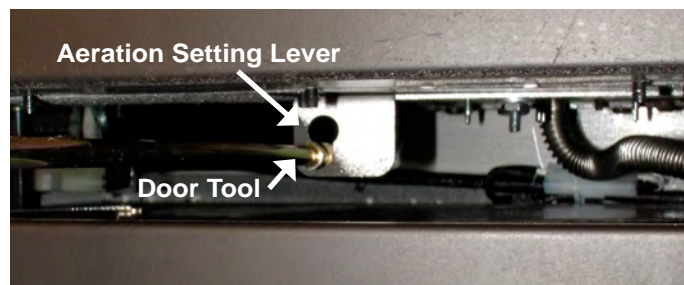

Figure 6 Sec.10



# Operation

## Remote Operation

The Proflame 2 System consists of the following elements:

1. Pilot Assembly
2. Proflame Gas Valve.
3. Proflame 2 Control Module
4. Wiring Harness
5. Variable Speed fans
6. Variable Accent Lights
7. Proflame 2 remote control
8. Battery Pack
- 9 Manual override switch

**NOTE:** Can not be used with home automation systems.

The Proflame 2 Transmitter controls the following fireplace functions:

1. Main Burner On/Off
2. Main Burner flame modulation (6 levels).
3. Choice of standing or intermittent pilot (CPI/IPI).
4. Thermostat and Smart thermostat functions.
5. Variable Accent light (6 Levels).
6. Fan speed modulation (6 levels).

The Proflame 2 Transmitter uses a streamlined design with a simple button layout and informative LCD display, see **Figure 8 Sec.10**. A Mode Key is provided to index between the features and a Thermostat Key is used to turn On/Off or index through Thermostat functions, see **Figure 10 Sec.10**. Additionally, a Key Lock feature is provided.



Figure 8 Sec.10 Proflame 2 Remote Control

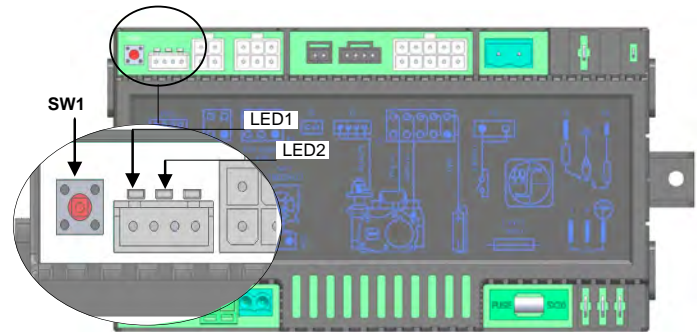

**SW1 = Programming Button**

**LED1 = Red Diagnostic Light**

**LED2 = Amber Programming Remote Control Light**

Figure 9 Sec.10 Proflame 2 Control Module

**⚠ WARNING**

Do not expose remote control to temperatures below 0°C (32°F) or above 50°C (122°F)

**⚠ CAUTION**

Property Damage Hazard. Excessive heat can cause property damage. The appliance can stay lit for many hours. Turn off the appliance if it is not going be attended for any length of time.

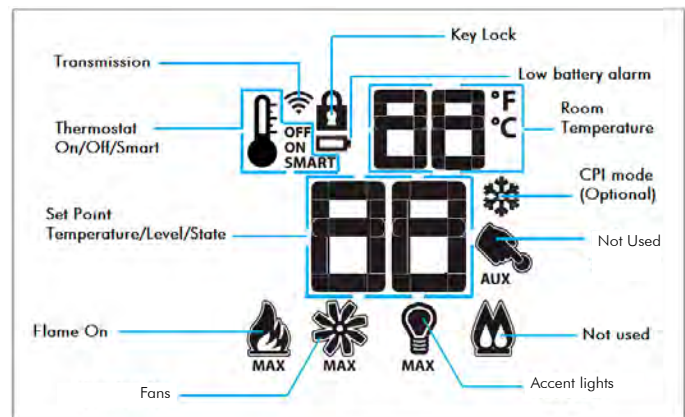

Figure 10 Sec.10 Remote Control LCD display.

# Operation



## Initializing the System for the first time

1. Set master override switch to off position.
2. Install four (4) AA batteries into the battery holder.
3. Install three (3) AAA batteries in the back of the remote control, see **Figure 11 Sec.10**.

Note the polarity of batteries and install them as indicated by the silk screen (+/-) on the holder.

4. Connect AC Power (115 volts, 60 Hz) to fireplace.

## Operating the System for the first time

5. Press SW1 button on the control module. The control module will beep three (3) times and an amber LED is illuminated to indicate that the IFC is ready to synchronize with a remote control within 10 sec. Push the ON button. The control module will "beep" four (4) times to indicate transmitter's command is accepted.

**The System is now initialized.**



## WARNING

Battery operated device. Read the battery instructions before installing them into the system. Do not expose any battery, or its holder, or a device in which batteries are installed, to a working temperature greater than 54°C / 129°F.



Figure 11 Sec.10 Remote control battery compartment.

## Temperature indication Display

With the system in the "Off" position, press the Thermostat Key and the Mode Key at the same time. Look at the LCD screen on the Remote Control to verify that a C or F is visible to the right of the Room Temperature display, see **Figure 12 Sec.10**.

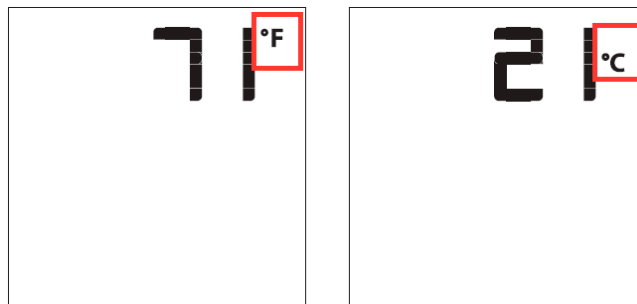

Figure 12 Sec.10 Remote Control display in Fahrenheit & Celsius.

## Turn On the Fireplace

With the system Off, turn the master override switch to on and press the On/Off Key on the Remote Control. The Remote Control display will show some other active Icons on the screen. At the same time the Control Module will activate the fireplace. A single "beep" from the Control Module will confirm reception of the command.

## Turn Off the Fireplace

With the system On, press the On/Off Key on the Remote Control. The Remote Control LCD display will only show the room temperature, see **Figure 13 Sec.10**. At the same time the Control Module will turn off the fireplace. A single "beep" from the Receiver confirms reception of the command.



Figure 13 Sec.10 Remote Control display.



# Operation

## Remote-Flame Control

When you turn on the fireplace it starts on high. The proflame 2 has six (6) flame levels. Each time you press the Down Arrow Key once the flame height will reduce by one step.

You can continue this until the main burner flame turns off. You can still operate the accent lights and fans in this mode.

If the main burner flame is off and you press the up arrow key once, the flame will automatically go to high, see **Figures 14 Sec.10** and **15 Sec.10**.

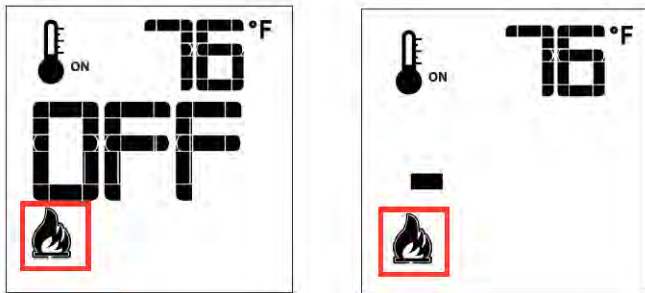

Figure 14 Sec.10 *Flame Off and Flame Level 1.*

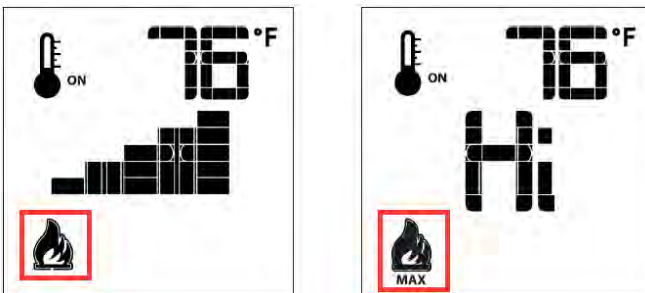

Figure 15 Sec.10 *Flame Level 5 and Flame Level Maximum.*

## Room Thermostat (Remote Control Operation)

The Remote Control can operate as a room thermostat. The thermostat can be set to a desired temperature to control the comfort level in a room. To activate the function, press the Thermostat Key, see **Figure 8 Sec.10**. The LCD display on the remote control will change to show that the room thermostat is "On" and the set temperature is now displayed, see **Figure 16 Sec.10**. To adjust the set temperature press the Up or Down Arrow Keys until the desired set temperature is displayed on the LCD screen of the Transmitter.

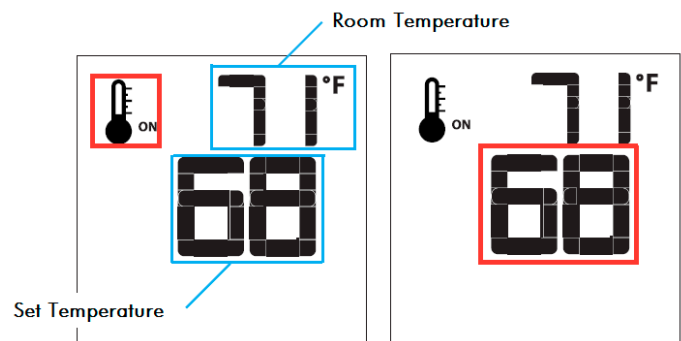

Figure 16 Sec.10 *Setting Room Thermostat*

## Smart Thermostat (Remote Control Operation)

The Smart Thermostat function adjusts the flame height in accordance to the difference between the set point temperature and the actual room temperatures. As the room temperature gets closer to the set point the Smart Function will modulate the flame down. To activate the function, press the Thermostat Key, see **Figure 8 Sec.10**, until the word "SMART" appears to the right of the temperature bulb graphic, see **Figure 17 Sec.10**.

**NOTE:** When smart Thermostat is activated, manual flame height adjustment is disabled.

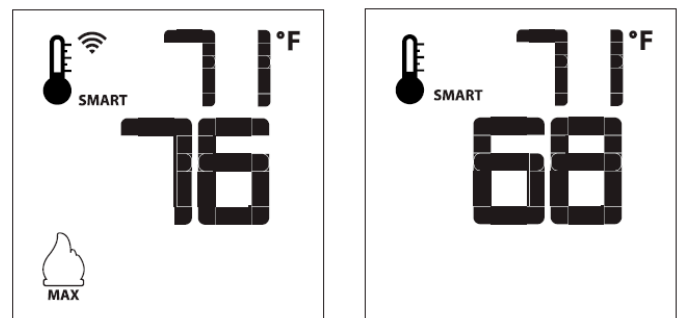

Figure 17 Sec.10 *Smart flame function*



# Operation



## Disabling Thermostat

Some jurisdictions and bedroom installations require the thermostat to be disabled.

1. Partially take out one battery, see **Figure 18 Sec.10**.
2. Insert the battery while holding down the thermostat button. The remote screen will display 'Clr' while the button is held down. See **Figure 19 Sec.10**.
3. To enable thermostat repeat steps 1-2. The remote screen will display 'set' while the thermostat button is held down.



Figure 18 Sec.10



Figure 19 Sec.10 *Light Control*

## Fan Speed Control

The fireplace is equipped with optional hot air circulating fans. The speed of the fans can be controlled by the Proflame system. The fan speed can be adjusted through six (6) speeds. To activate this function use the Mode Key, see **Figure 8 Sec.10**, to index to the fan control icon, see **Figure 20 Sec.10**. Use the Up/Down Arrow Keys, see **Figure 8 Sec.10**, to turn on, off, or adjust the fan speed, see **Figure 20 Sec.10**. A single "beep" will confirm reception of the command.

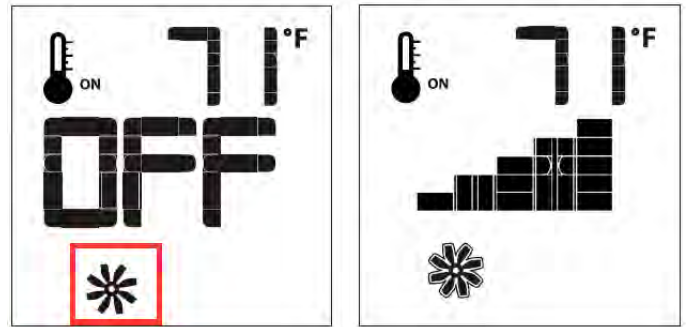

Figure 20 Sec.10 **Fan Speed Control**

## Accent Light Control

The fireplace is equipped with variable accent lights. The accent light function controls the Accent Lights. To activate this function use the Mode Key, see **Figure 8 Sec.10**, to index to the accent light icon, see **Figure 21 Sec.10**.

Pressing the Up Arrow Key will turn the light on at the lowest setting. Continue pressing up to get brighter. Pressing the Down Arrow Key will turn the lights down until you get to the off position. A single beep will confirm the reception of the command.

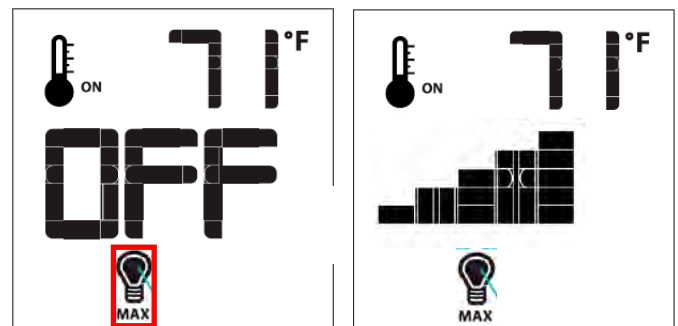

Figure 21 Sec.10 **Light Control**



# Operation

## Continuous Pilot (CPI) Selection (Optional)

In cold weather climates, the pilot burner can stay on continuously to prevent condensation or cold air temperatures near the fireplace glass. **Note**, some jurisdictions do not permit use of continuous pilot system. Check local codes or contact your Montigo dealer.

With the system in "off" position press the Mode Key, see **Figure 8 Sec.10**, to index to the CPI mode icon, see **Figure 22 Sec.10**. Pressing the Up Arrow Key will activate the Continuous Pilot Ignition mode (CPI). Pressing the Down Arrow Key will return to IPI. A single "beep" will confirm the reception of the command.

**NOTE:**

- Requires CPI/IPI jumper cable installed.

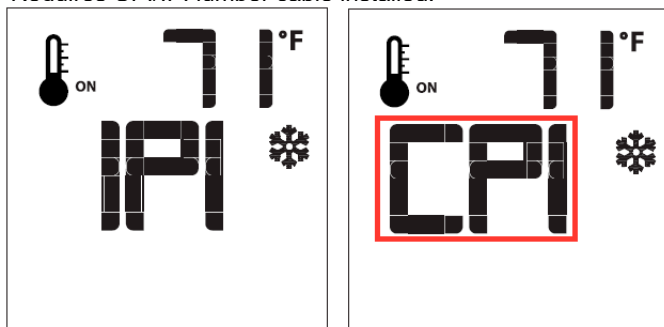

Figure 22 Sec.10 Continuous Pilot / Intermittent Pilot Selection

## Key Lock

This function will lock the keys to avoid unsupervised operation. To activate this function, press the Mode and Up Keys at the same time, see **Figure 23 Sec.10**. To de-activate this function, press the Mode and Up Keys at the same time.

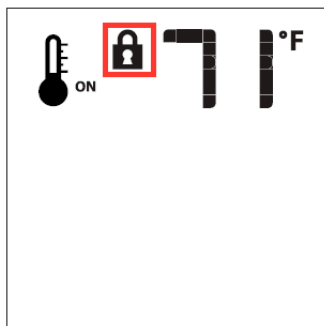

Figure 23 Sec.10 Key Lock

## Low Battery Power Detection

The life span of the batteries depends on various factors: quality of the batteries used, the number of ignitions of the appliance, the number of changes to the room thermostat set point, etc.

### Remote Control

When the Remote Control batteries are low, a Battery Icon will appear on the LCD display of the Remote Control, see **Figure 24 Sec.10**, before all battery power is lost. When the batteries are replaced this icon will disappear.

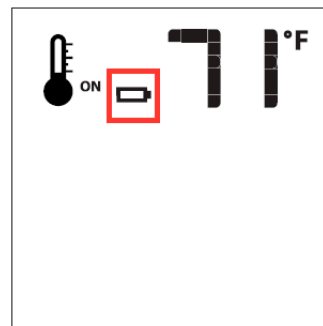

Figure 24 Sec.10 Low Battery Power Detection

### Control Module

When the back-up batteries are low, a "double-beep" will be emitted from the IFC when it receives an On/Off command from the Remote Control. This is an alert for a low battery condition of the receiver and after that no more commands will be accepted. When the batteries are replaced the "beep" will be emitted from the receiver as soon as powered.

# Operation

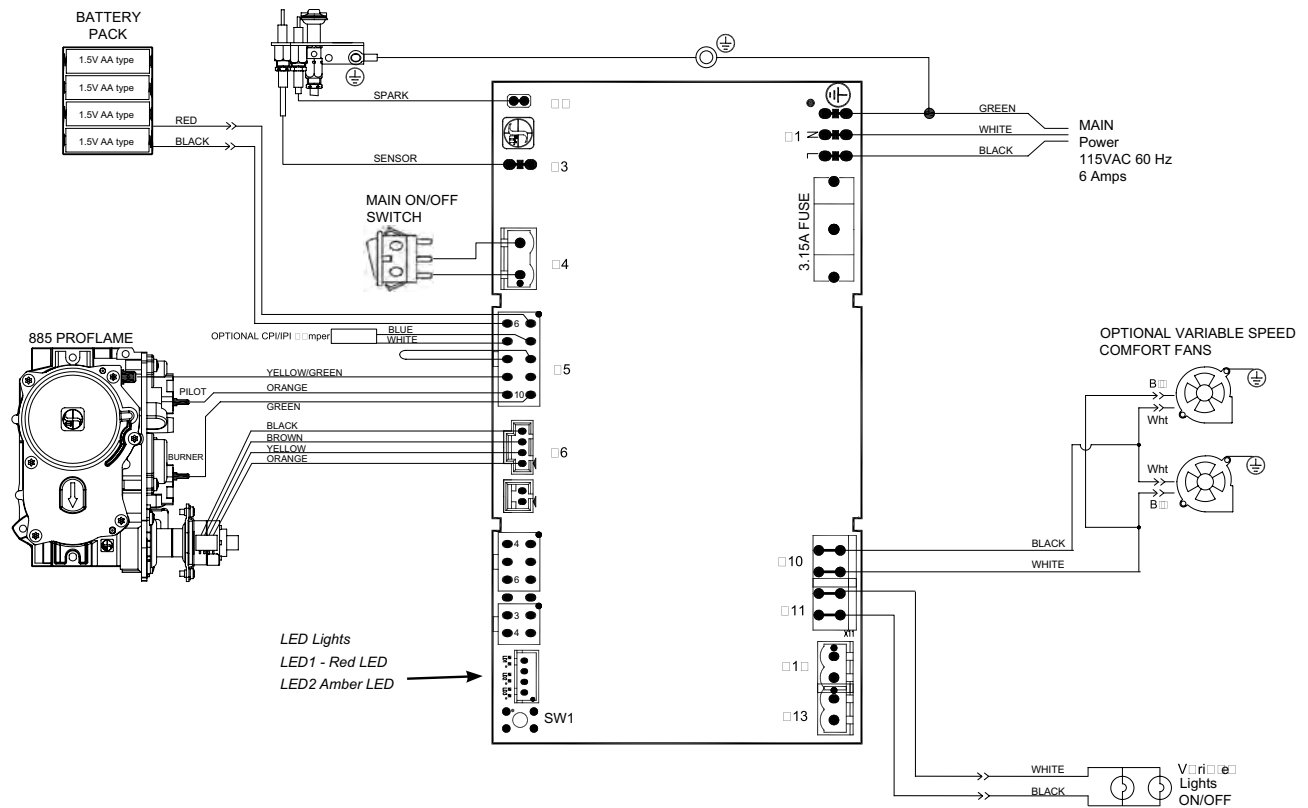
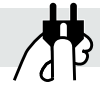

Figure 25 Sec.10 Proflame 2 Wiring Diagram



## CAUTION

Label all wires prior to disconnection when servicing controls. Wiring errors can cause improper and dangerous operation. Verify operation after servicing.



## Maintenance

### Burner Installation / Removal

Your new fireplace is shipped with the burner already in position. Periodically, the burner needs to be cleaned and inspected or perhaps if the pilot needs service or the unit is to be converted to LP, you will need to remove and/or re-install the burner. The burner is mounted to the fireplace in 3 places. At the rear of the burner is the Mixing Tube. At the front are two small tabs which fit through a slot and are simply bent to keep the Burner secure.

\*\* The Burner is a cast ceramic material. It is easily chipped or scratched. Take care when handling, removing or re-installing the burner not to damage it. \*\*

\*\* When installing or removing the Burner, take due care not to damage the Pilot Assembly. The Burner has to be lifted over the Pilot in either case and contact with the Pilot should be avoided \*\*

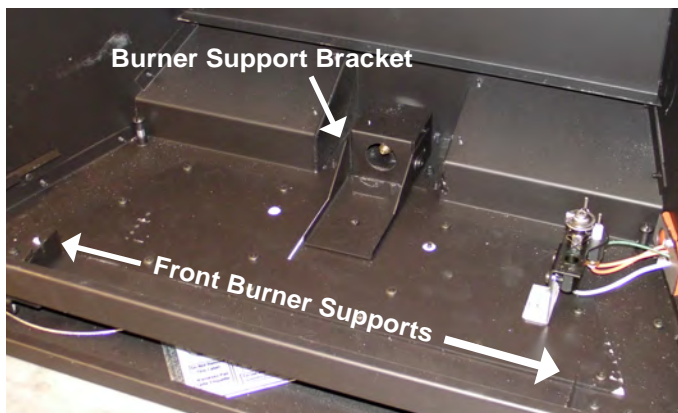

Figure 26 Sec.10 Burner support bracket location

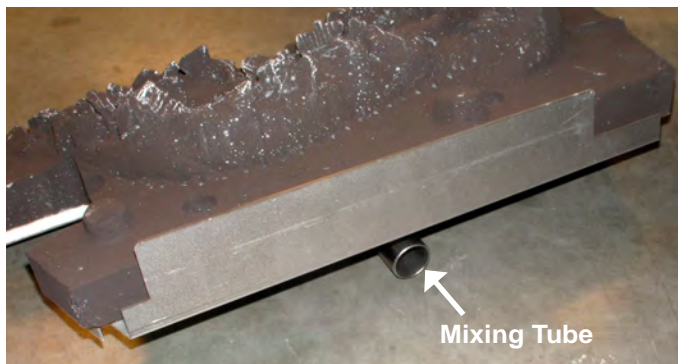

Figure 27 Sec.10 Log burner mixing tube

### Burner Removal

1). Using a small screw driver or pliers, bend the tabs straight so that they will fit through the slots when the burner is removed.



Figure 28 Sec.10

2). By grasping the burner at either side (if the Firebox Panels are both removed) or at the front and rear, first lift the front of the Burner up about 1-2 inches. Then pull the Burner towards you to remove the Mixing Tube from the Rear Burner Support. Lift the Burner out of the Firebox and store in a place where it won't get damaged.



Figure 29 Sec.10

# Maintenance



## Burner Installation

- 1). By grasping the burner with both hands, angle the burner into the rear of the firebox to engage the Mixing Tube into the Burner Support Bracket. The Mixing Tube goes into the Burner Support Bracket. If it does not go into the Burner Support Bracket, you will not get the burner to line up at the front and the burner may not operate correctly.
- 2). Once you have the Mixing Tube situated into the Rear Burner Support, lower the front of the Burner over the Front Burner Supports. Using the same small screw driver or pliers, bent the tabs just enough that the burner cannot be moved from its position.
- 3). Check again that the Mixing Tube is still inside the Rear Burner Support by grasping the rear of the Burner and pulling up. If the Mixing Tube is properly installed, the Log Burner will not move. If the Burner does rise up, stop and trouble shoot this situation. The Log Burner will not operate safely if this connection is not proper.



Figure 30 Sec.10



Figure 31 Sec.10 Log burner correctly installed



## Maintenance

### Accent Light Replacement

Replacement of the fireplace accent lights can be performed with a few simple steps. The accent lights are located at the top of the fireplace near the front on either side. Although they can be changed without removing any components, it would be easier to remove the Fireplace Panels and Upper Retaining Clip.

We recommend that if you have a need to replace one bulb, you replace them all at the same time. Another option would be to replace them at the same time as your annual service.

- 1). Disconnect the electrical and gas supply to the unit.
- 2). Remove door and safety screen barrier from the unit.
- 3). See the section on Fireplace Panel Installation for information on how to remove the Panels. Once they have been removed, the Upper Panel Retainers can be removed.



Figure 32 Sec.10

- 4). To remove a bulb, pull it out of its socket. New bulbs can be bought at most national hardware stores or through your Montigo fireplace dealer. See specs page for information on bulbs. If you supply your own bulbs, do not use greater than 20 watt bulbs.



Figure 33 Sec.10

- 5). Replace the Upper Panel Retainers and Firebox Liners.

### Optional Fan / Blower Replacement

The Optional Fans or Blowers supplied with your fan kit are the best quality available. These Fans should provide many years of trouble free service. There are 2 blowers for this appliance, one which has the motor on the right side and the other on the left side.

\*\* If the fireplace is installed, the Gas Supply may need to be disconnected from the Appliance. If this is the case, a licensed gas fitter will need to provide this service. Images of RKFID High Output Fan Kit shown. Installation instructions are the same for RKFIDECO Economy Fan Kit.\*\*

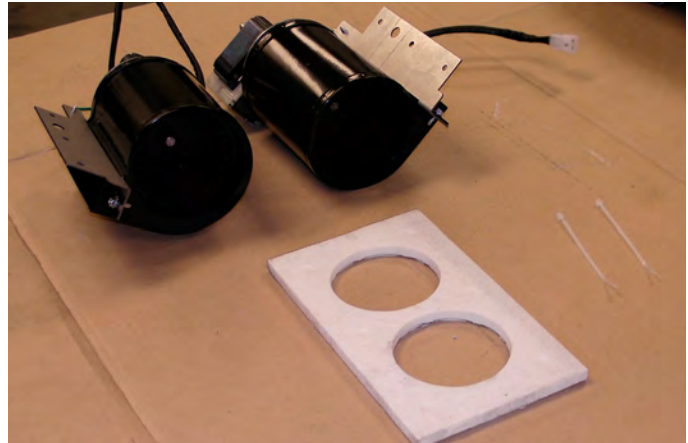

Figure 34 Sec.10

- 1). If installed, disconnect Electrical Power. **Always disconnect the power when servicing any appliance.**
- 2). Remove Front and Rear Faceplate. See the section on Faceplate installation for details.
- 3). Remove the Flue Collar Slide Plate. See the section on Vent Connection for details.
- 4). Remove the Fireplace from the cavity.
- 5). Remove all screws necessary to remove the Outer Shell Back.

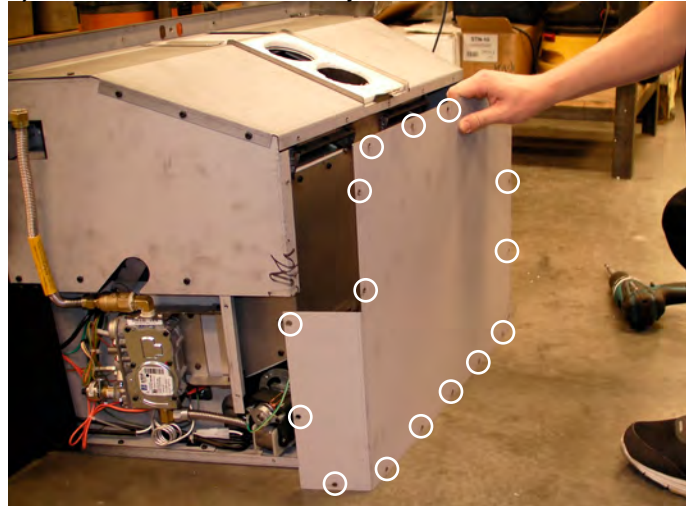

Figure 35 Sec.10

# Maintenance



6). Cut the Zip Strap holding the Fan Wire Harness.

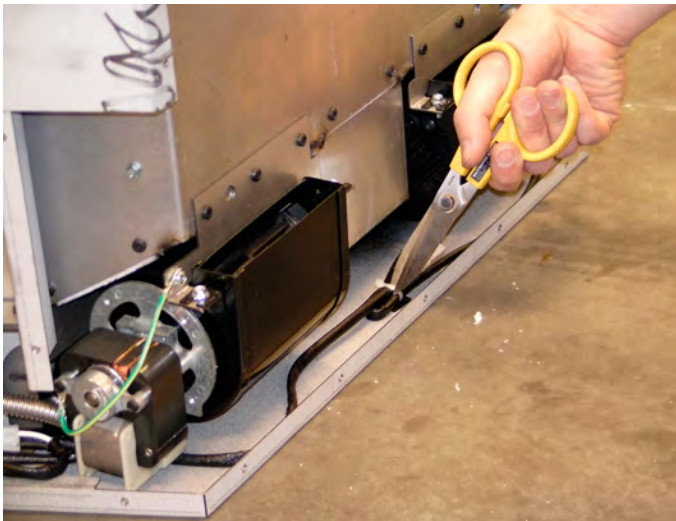

Figure 36 Sec.10

9). Disconnect the Fan Wire Harness at the back as well.



Figure 39 Sec.10

7). Cut the Zip Strap that holds the Fan Wire Harness in the Valve Compartment.



Figure 37 Sec.10

10). Remove 3 screws that mount each fan in place.

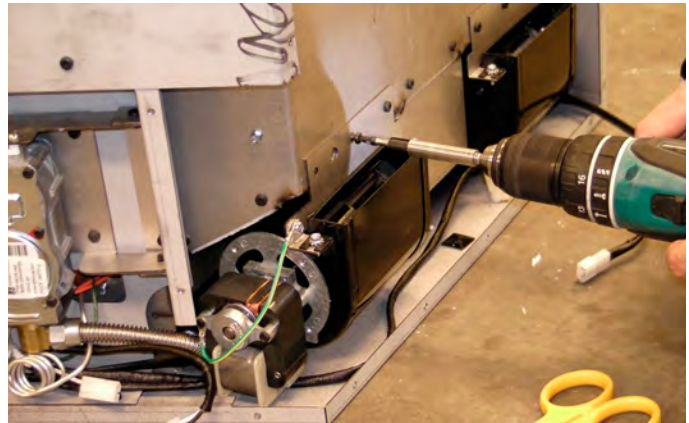

Figure 40 Sec.10

8). Disconnect the Fan Wire Harness.



Figure 38 Sec.10

11). Remove the Blowers from the Fireplace.



Figure 41 Sec.10



## Maintenance

**12).** Install both new Blowers. Secure the Wire Harness with the Zip Straps shown in the 2 pictures below.

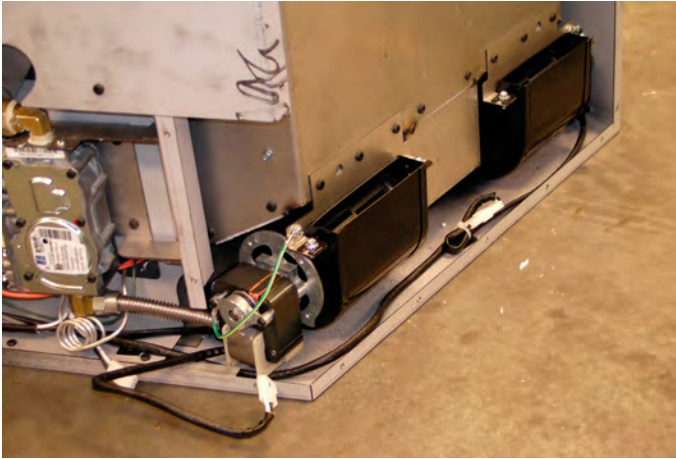

Figure 42 Sec.10



Figure 44 Sec.10

**13).** At this point, if you want to test the Blower operation, do so with the Gas Supply turned off or disconnected. To test the Blower operation, you will need to re-connect the electrical supply temporarily. Disconnect the Electrical Supply after testing the Blowers.

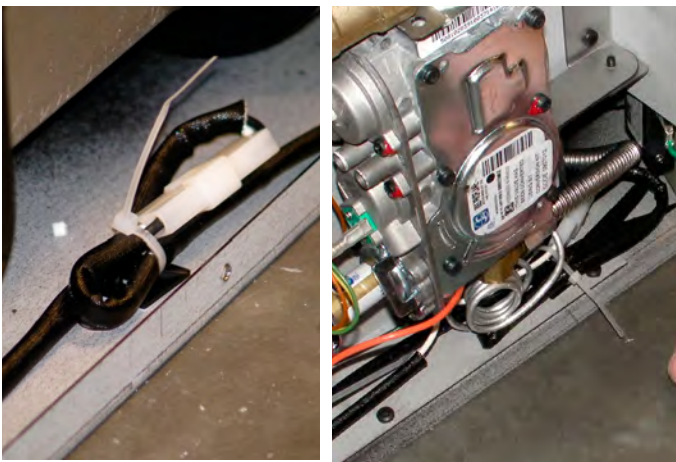

Figure 43 Sec.10

**14).** Re-install the Outer Shell Rear panel.

**15).** You will need to replace the Flue Collar Plate Gasket prior to re-installation into the cavity.

**16).** Replacing the Flue Connector Plate Gasket.

**17).** Re-install the unit into the Cavity. See the section on Vent Connections.

**18).** Re-install the Face Plate Panels. See the section on Setup.

**19).** Re-connect the Electrical Supply.



# Maintenance



## Window Cleaning / Screen Removal

All units are supplied with a Safety Barrier (screen) to prevent accidental touching of the hot glass. Glass doors however do require periodic cleaning. How often they need to be cleaned depends on several factors like how often the appliance is run, the prevailing temperatures in your area or even air quality. When cleaning the Window, you should clean both the inner on outer surfaces. In order to clean the outer surface, you will need to remove the Safety Barrier.

1). Remove the Fireplace Door. See the section on Setup for details on door installation and removal.



Figure 45 Sec.10

2). On a flat work surface, place the Door with the Safety Barrier facing up. Remove 4 screws that attach the Safety Barrier to the Firebox Door.

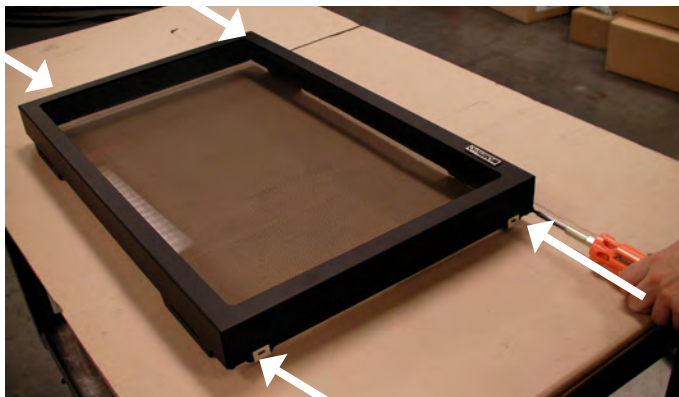

Figure 46 Sec.10

3). Lift the Safety Barrier away from the Firebox Door.

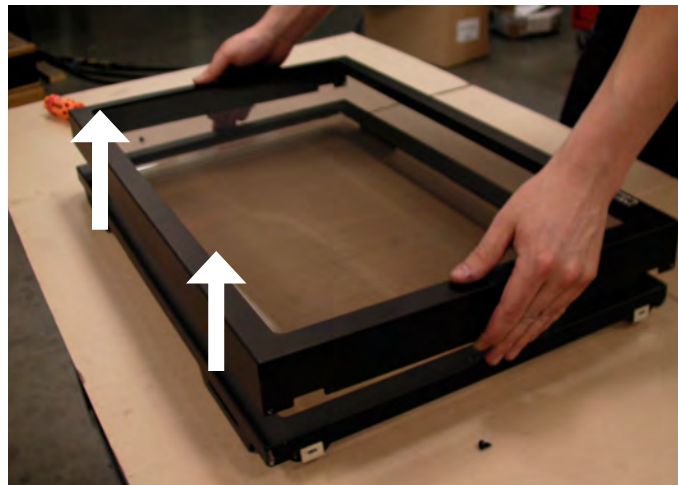

Figure 47 Sec.10

4). Using a non-abrasive cleaner, clean both the inner and outer surface of the Window.



Figure 48 Sec.10

5). Re-install the Safety Barrier and the Firebox Door in the reverse order they were removed.



## Maintenance

### Battery Replacement

We recommend that the batteries in this appliance be replaced at the start of each heating season even if they appear to be operational. You do not want to find out that you have dead batteries during a harsh winter storm. If you use your appliance often, they may need to be replaced more than once a year. See the section on Installation for information on the Battery installation for the Controller Backup. See the section on Remote Operation for information on how to install batteries in the hand held Remote Control.

### Heat Exchanger Bypass

This appliance was designed and built to meet newly proposed rules of efficiency proposed by Federal Regulatory Agencies. A great deal of engineering time was spent to ensure this appliance would provide years of reliable and durable service while operating at a very high efficiency level. Keeping this in mind, there may be several conditions where this level of efficiency may not be desirable. If you are operating this appliance at a very high altitude or in extremely cold climates, start-up may be difficult. There may also be a situation where the high level of efficiency isn't wanted such as if the unit is located in a very small room and the heat output is simply too great. An optional bypass has been designed into the heat exchanger which when removed reduces the operational efficiency by approximately 10%. If it is desired you can utilize the bypass by following these simple steps.

- 1). Always disconnect the electrical supply to the appliance. Shut off the fuel supply to the appliance before any service work is done.
- 2). Remove the Door, Firebox Panels and Burner. See the appropriate sections in this manual for instructions on those procedures.
- 3). Remove the right and left hand Upper Firebox Liner Retainers.



Figure 49 Sec.10

# Maintenance



4). Remove 3 screws that hold the Firebox Baffle in location.



Figure 50 Sec.10

5). The Firebox Baffle can be lowered at the front and then pulled forward away from 2 studs that secure the rear.

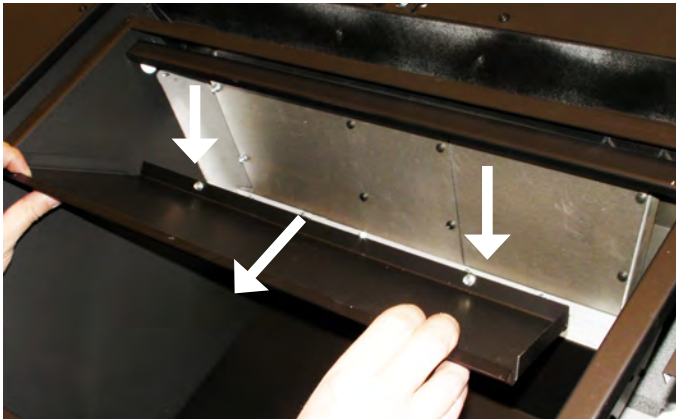

Figure 51 Sec.10

6). Remove the 4 screws that secure the bypass plate to the bottom of the Heat Exchanger.

CAUTION: Screws may be tight. Use DW40 to help reduce the risk of screws stripping or breaking heads.



Figure 52 Sec.10

7). Once the Restrictor has been removed, it is important that you return the screws to their locations again.

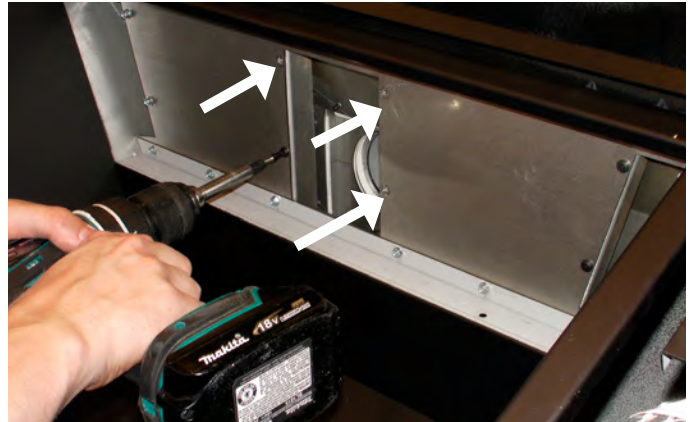

Figure 53 Sec.10

8). Re-install the Firebox Baffle, left and right Upper Firebox Panel Retainers, Firebox Panels and Burner assembly and door.



## Maintenance

### Pilot Maintenance / Replacement

We suggest throughout this manual that maintenance on this product should be performed yearly. This is the best practice in order to keep your fireplace insert running reliably for many years to come. One of the items that should be inspected yearly and may need service is the Pilot Burner Assembly. The Pilot Burner Assembly is responsible for lighting the appliances and provides the safety mechanism to ensure that the appliance performs safely. In order to service the pilot, the Door, Burner Assembly, Log set etc. must first be removed. There are specific sections in the manual that cover those procedures. Replacing the pilot can be performed with the following steps.

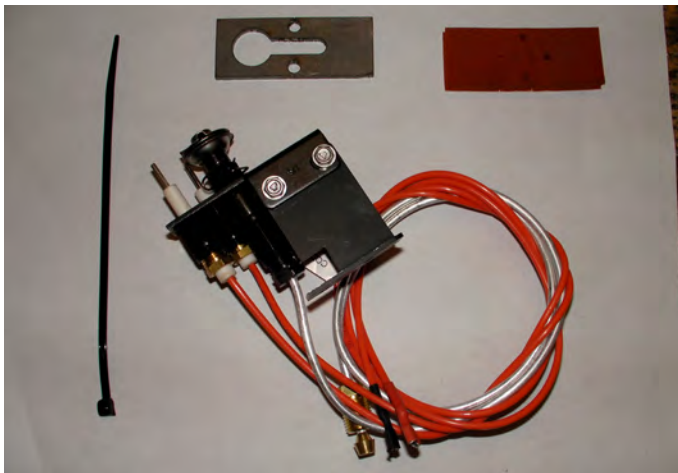

Figure 54 Sec.10 Pilot Replacement Kit shown

- 1). Disconnect Gas and Electrical Supply to the Appliance. You will need to have the unit outside the install to access the Valve location. If the unit has already been installed, see the sections on removing the Faceplate Panels and Vent Connections.
- 2). Remove the Firebox Panels and Burner Assembly (see appropriate sections)
- 3). Remove the 2 screws that hold the Pilot Assembly Mounting Brackets to the floor of the Firebox.

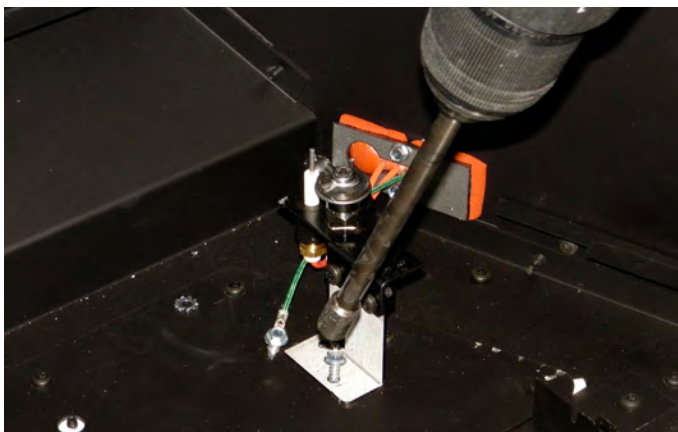

Figure 55 Sec.10

- 4). Remove the 2 screws that hold the Pilot Bulkhead Plate and Gasket to the Firebox Wall. The Gasket may be stuck to the wall and may need to be pried off.

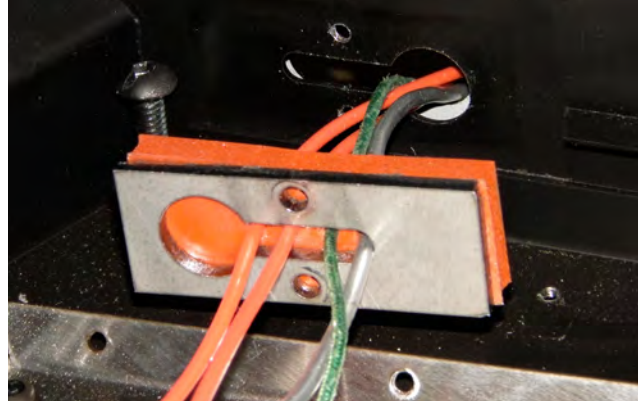

Figure 56 Sec.10

- 5). Remove screws by holding valve mounting bracket. Swing valve out. Disconnect the Pilot Line from the bottom of the Gas Valve.

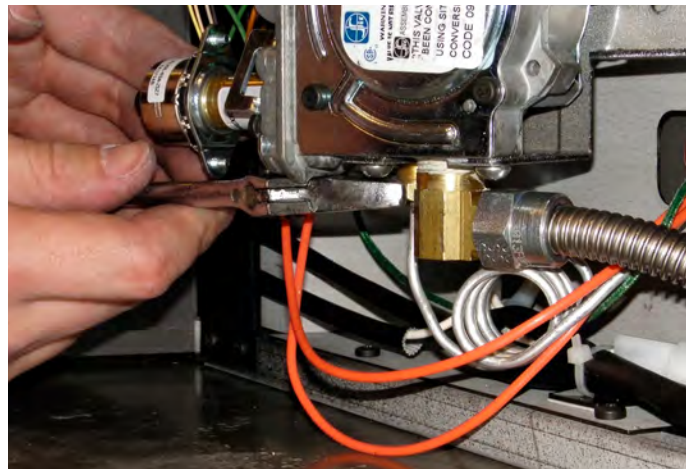

Figure 57 Sec.10

- 6). Remove the 2 screws with hold the top of the Control Panel Mounting Bracket to the Outer Shell of the fireplace.

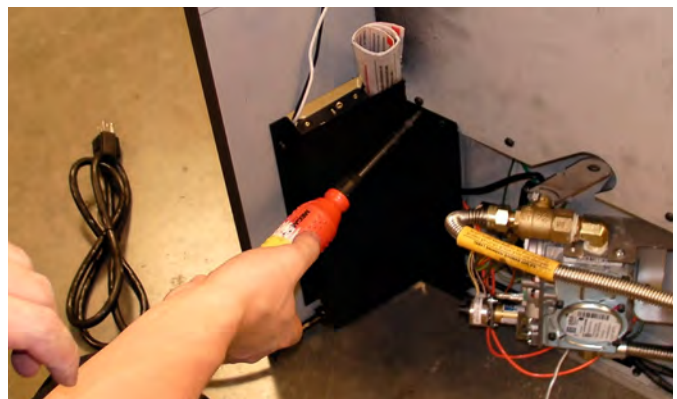

Figure 58 Sec.10

# Maintenance



7). Disconnect both the Ignition Lead and the Flame Sensor Lead from the front of the Control Panel

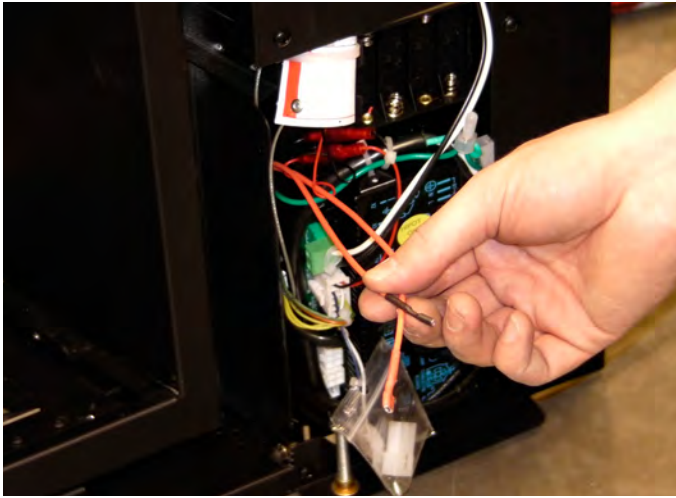

Figure 59 Sec.10

8). Feed the 2 electrical lines from the Control Board to beside the unit.



Figure 60 Sec.10

9). From the inside of the Firebox, pull the Pilot Assembly, Bulk Head Plate, Gasket and 3 lines through the Firebox and out of the unit. Leave ground wire in the firebox.

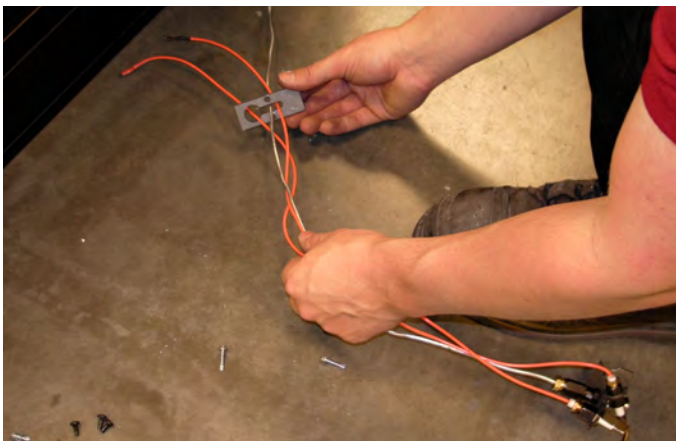

Figure 61 Sec.10

10). Install the replacement Components in the reverse order, through the Firebox wall. Install the Pilot Assembly Bracket to the Firebox floor with 2 screws. Pass the wires through rubber gasket. Make sure the pilot gas line goes through the far right hole of the gasket and the cuts in the gasket face up. Make sure that the Ground Wire, Star Washer and screw are assembled to the bottom of the Pilot Mounting Bracket as shown in the picture below.



Figure 62 Sec.10

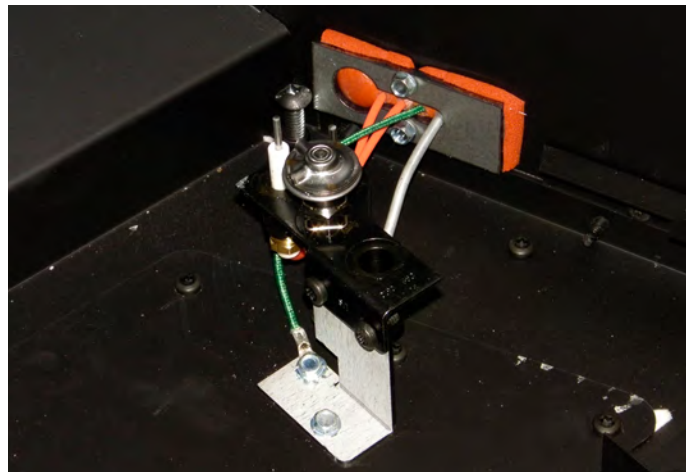

Figure 63 Sec.10

11). Using a round object, something like a Socket Wrench, loop the excess Pilot Line into a coil. Be very careful not to kink the line.



Figure 64 Sec.10



## Maintenance

- 12). Attach the Pilot line back into the valve, being very careful not to over-tighten the line.
- 13). Feed the 2 electrical wires in between the shell of the unit and the Control Board and plug them into the appropriate terminals on the control board.
- 14). Tie up excess wires and zap strap. Take care to not pinch or kink wires and pilot gas line.

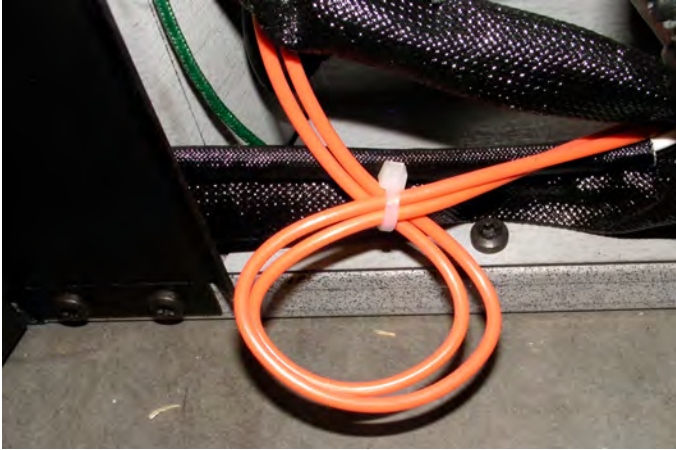

Figure 65 Sec.10

- 15). Reverse these steps for reinstallation. Re-connect Gas and Electrical supply.

# Maintenance



## Control Board Replacement

The Control Set used in this appliance (SIT Proflame 2) has all the electronics and receiver built into one module. If this module ever has to be replaced, follow these simple steps:

- 1). Disconnect the appliance from the main power and shut off any gas supply prior to performing any maintenance on this appliance.
- 2). A Replacement Control Board can be acquired from your Montigo dealer.

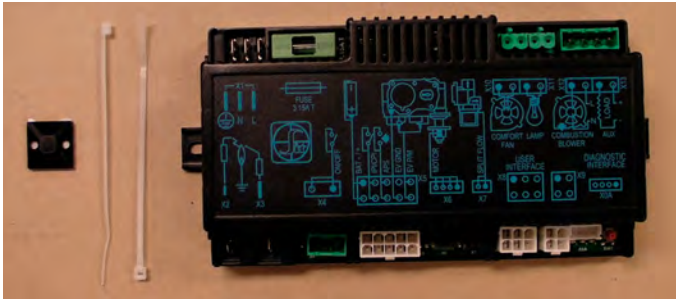

Figure 66 Sec.10 Replacement control board

- 3). Remove the Front Faceplate. See the appropriate section for instruction on Faceplate removal.
- 4). Carefully cut the zip strap that secures some of the wires from the top of the Control Board.

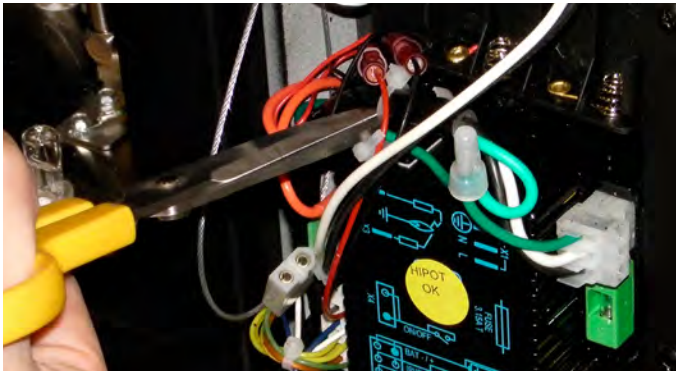

Figure 67 Sec.10

- 5). Unplug all of the electrical connections on the left and right side of the board.



Figure 68 Sec.10

- 6). Remove the screws that fasten the board to the Mounting Bracket. One is located above and one below the board.



Figure 69 Sec.10

- 7). Remove and replace the board with the new unit.

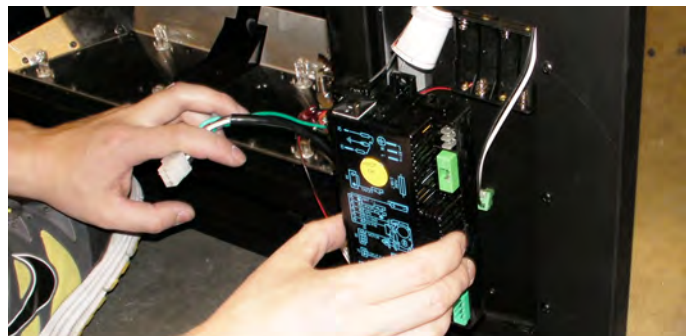

Figure 70 Sec.10

- 8). Stick the little Zip Strap and Retaining Pad to the top of the Control Board.

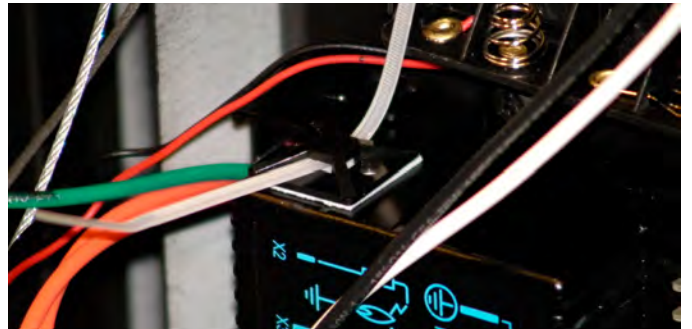

Figure 71 Sec.10

- 9). Using the Zip Strap, secure all the wires neatly into the Control Box Area. Re-connect the Electrical and Gas supply.



Figure 72 Sec.10



## Maintenance

### Control Board Fuse Replacement

The Control Set used in this appliance (SIT Proflame 2) has one fuse that could potentially need replacement. See spec sheet for fuse or contact your Montigo Dealer.

- 1). Disconnect the Electrical and Gas supply to the appliance.
- 2). Remove the Front Faceplate from the appliance.
- 3). The Fuse is in a plastic retainer, located on the right side of the Control Board. The Plastic Retainer plugs into the Control Board as a Cable End would. You may have to gently use a screw driver to wiggle this away from the Control Board.

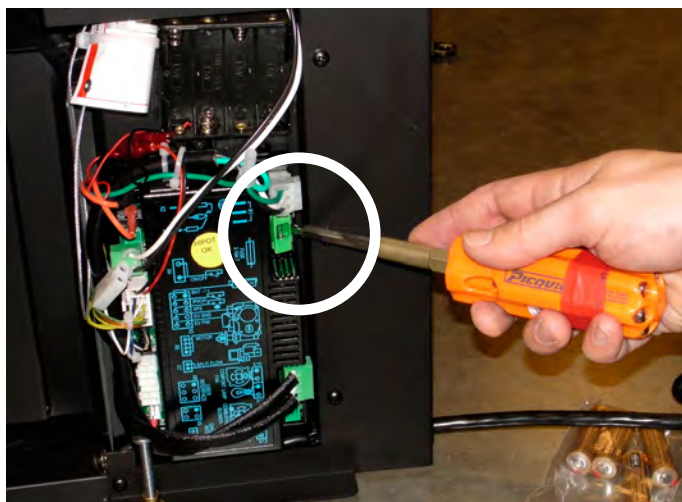

Figure 73 Sec.10

- 4). Remove and replace the Fuse from the Plastic Retainer.

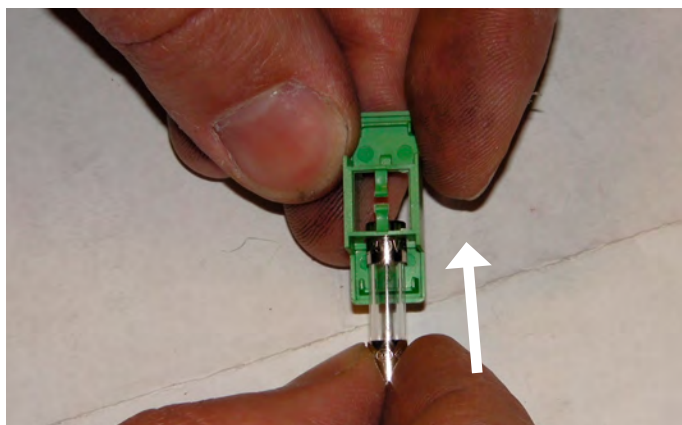

Figure 74 Sec.10

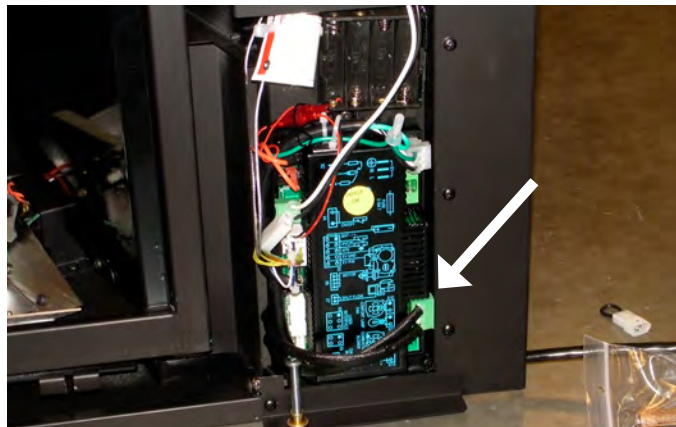

Figure 75 Sec.10

- 4). Re-install the Plastic Retainer into the Control Board.
- 5). Re-install the Front Faceplate.
- 6). Re-connect Electrical and Gas supply to the appliance.



# Maintenance



## Vent Maintenance / Inspection

Part of the annual maintenance on this appliance should include a thorough inspection of the entire Venting and Termination. Vent inspection should include:

**Roofing Inspection and repair should only be performed by a licensed and qualified roofing professional.**

- 1). Attachment to the Fireplace
  - a. Make sure that the attachment of the venting to the top of the Appliance is tight, secure and that no corrosion has affected the venting's integrity.
  - b. Make sure that both vents (incoming & outgoing) are secure and that these flexible liners have not been kinked, restricted or damaged in any way.
  - c. Make sure there are no "dips" in the venting. Condensation can collect and affect the performance of the Fireplace if the venting is not vertical in all areas.
- 2). Roof Termination
  - a. Make sure that all sealing materials are in good condition and that there is no opportunity for moisture to access the building.
  - b. Make sure there are no signs of corrosion to the Vent Termination or Roof Flashing
  - c. Make sure there are no signs of intrusion by any birds or pests of any kind. Make sure animals have not built any nests anywhere in the vicinity of the Vent Termination.
- 3). Attachment to the Vent Termination
  - a. If you have to re-seal a Vent Termination or Roof Flashing, firstly make sure the Venting is secure to the Termination or Vent Adaptor. Make sure there are no signs of corrosion anywhere in the venting system.



# Maintenance

## SIT Proflame 2 Troubleshooting:

The following is a troubleshooting chart of possible problems:

PROBLEM	SOLUTION
Pilot Igniter won't spark	<ol style="list-style-type: none"> <li>1. Check the master override switch and turn ON</li> <li>2. Ensure main power is ON and new batteries are installed in the remote control and backup battery pack</li> <li>3. Make sure remote is synced with control board.</li> <li>4. Check the 3.15A fuse in the control box and replace if necessary</li> <li>5. Make sure remote is not in smart or thermostat mode.</li> <li>6. Check igniter wire is connected to the control board and is not damaged</li> </ol>
Pilot Igniter sparking, but Pilot burner will not light	<ol style="list-style-type: none"> <li>1. Verify the Inlet and Manifold Gas Pressure are within acceptable limits</li> <li>2. Check all connections to gas valve</li> <li>3. Check fuel supply valves and emergency shut off valve is open</li> <li>4. Check wiring connections from control board to valve</li> </ol>
Pilot lights, but Main burner will not Light	<ol style="list-style-type: none"> <li>1. Check and verify all wiring connections as per the wiring diagram.</li> <li>2. Verify the inlet and Manifold Pressure are within acceptable limits</li> </ol>
Pilot lights, but Main burner will not Light and igniter continues to spark	<ol style="list-style-type: none"> <li>1. Check the Pilot Flame Sensor Rod and clean with steel wool or similar.</li> <li>2. Check the Pilot hood and clean with steel wool if dirty.</li> <li>3. Check flame sensor wire is plugged control board and is not damaged</li> <li>4. Adjust pilot flame using the pilot adjustment screw if the pilot flame is too long or too short (Flame should fully engulf the sensor rod and must be stable)</li> <li>5. Check supply pressure</li> <li>6. Check and make sure the ground wire from the pilot is connected to the fireplace body</li> </ol>
Fans not working	<ol style="list-style-type: none"> <li>1. Ensure main power is ON and is plugged in (fireplace may be operating on back up batteries).</li> <li>2. Check the 3.15A fuse in the control box and replace if necessary</li> <li>3. Make sure fans are plugged into the control board</li> </ol>

PROBLEM	SOLUTION
Lights not working	<ol style="list-style-type: none"> <li>1. Ensure main power is ON and is plugged in (fireplace may be operating on back up batteries).</li> <li>2. Check the 3.15A fuse in the control box and replace if necessary</li> <li>3. Make sure fans are plugged into the control board</li> <li>4. Bulbs are burnt out</li> </ol>
Control module beeps twice when On/Off button on remote is pressed and Red LED is On	<ol style="list-style-type: none"> <li>1. Replace batteries in battery pack</li> </ol>

If your fireplace still does not operate correctly, consult your local Montigo dealer.

**All service and repairs should be performed by a qualified licenced Technician.**

All spare parts, optional fans, and optional trim finishes are available from your local Montigo dealer.

# Appendix

## Appendix A: Warranty

### The Warranty

The Companies warrants the Montigo Gas Appliance to be free from defects in materials and workmanship at the time of manufacture. On the Montigo fireplace, there is a ten-year warranty on the firebox and its components, a five-year warranty on the main burner and pilot burner, and a one-year warranty on the gas control valve, fibre logs and Power Vent Module. The Glass, plated / painted finishes, and refractory lining are exempt from the warranty.

### Remedy And Exclusions

The coverage of this Warranty is limited to all components of the Gas Appliance manufactured by The Companies.

This Warranty only covers Montigo Gas Appliances installed in the United States or Canada.

If the components of the Gas Appliance covered by this Warranty are found to be defective within the time frame stated (see The Companies right of investigation outlined below). The Companies will, at its option, replace or repair defective components of the Gas Appliance manufactured by The Companies at no charge, and will also pay for reasonable labour costs incurred in replacing or repairing components. If repair or replacement is not commercially practical, The Companies will, at its option, refund the purchase price of the Montigo Gas Appliance.

This Warranty covers only parts and labour as provided above. In no case shall The Companies be responsible for materials, components, or construction which are not manufactured or supplied by The Companies, or for the labour necessary to install, repair or remove such materials, components or construction. All replacement or repair components will be shipped F.O.B. the nearest The Companies factory.

### Qualifications To The Warranty

The Gas Appliance Warranty outlined above is further subject to the following qualifications:

- (1) The Gas Appliance must be installed in accordance with The Companies installation instructions and local building codes. The Warranty on this Montigo Gas Appliance covers only the component parts manufactured by The Companies. The use of components manufactured by others with this Montigo Gas Appliance could create serious safety hazards, may result in the denial of certification by recognized national safety agencies, and could be in violation of local building codes. This warranty does not cover any damages occurring from the use of any components not manufactured or supplied by The Companies
- (2) The Montigo Gas Appliance must be subjected to normal use. The Gas Appliances are designed to burn gas only. Burning conventional fireplace fuels such as wood, coal or any other solid fuel will cause damage to the Gas Appliance, will produce excessive temperatures and will result in a fire hazard.

### Limitations On Liability

It is expressly agreed and understood that The Companies sole obligation, and purchaser's exclusive remedy under this Warranty, under any other warranty, expressed or implied, or in contract, tort or otherwise, shall be limited to replacement, repair, or refund, as specified above.

In no event shall The Companies be responsible for any incidental or consequential damages caused by defects in its products, whether such damage occurs or is discovered before or after replacement or repair, and whether or not such damage is caused by The Companies negligence. Some states do not allow the exclusion or limitation of incidental or consequential damages, so the above limitation or exclusion may not apply to you. The duration of any implied warranty with respect to this Montigo Gas Appliance is limited to the duration of the foregoing warranty. Some states do not allow limitation on how long an implied warranty lasts, so the above may not apply to you.

### Investigation Of Claims Against Warranty

The Companies reserves the right to investigate any and all claims against this Warranty and to decide upon method of settlement.

### The Companies Are Not Responsible For Work Done Without Written Consent

The Companies shall in no event be responsible for any warranty work done without first obtaining The Companies written consent.

### Dealers Have No Authority To Alter This Warranty

The Companies employees and dealers have no authority to make any warranties nor to authorize any remedies in addition to or inconsistent with those stated above.

### How To Register A Claim Against Warranty

In order for any claim under this Warranty to be valid, The Companies must be notified of the claimed defect in writing or by telephone, as soon as reasonably possible after the defect is discovered. Claims against this Warranty in writing should include the date of installation, and a description of the defect.

### Other Rights

This Warranty gives you specific legal rights, and you may also have other rights which vary from state to state.

**NOTE:** *The Companies* as stated above refer to - Canadian Heating Products Inc. and/or Montigo Del Ray Corp.

*Canadian Heating Products Inc. and/or Montigo DelRay Corp. reserves the right to make changes at any time, without notice, in design, materials, specifications, prices and also to discontinue colors, styles and products.*

# Appendix

## Appendix B: State of Massachusetts

### Amendment

#### (Gas Fireplace / Equipment sold in the State of Massachusetts)

#### 5.08: Modifications to NFPA-54, Chapter 10

**(1) Revise NFPA-54 section 10.5.4.2** by adding a second exception as follows:

Existing chimneys shall be permitted to have their use continued when a gas conversion burner is installed, and shall be equipped with a manually reset device that will automatically shut off the gas to the burner in the event of a sustained back-draft.

**(2) Revise 10.8.3** by adding the following additional requirements:

(a) For all side wall horizontally vented gas fueled equipment installed in every dwelling, building or structure used in whole or in part for residential purposes, including those owned or operated by the Commonwealth and where the side wall exhaust vent termination is less than seven (7) feet above finished grade in the area of the venting, including but not limited to decks and porches, the following requirements shall be satisfied:

**1. INSTALLATION OF CARBON MONOXIDE DETECTORS.** At the time of installation of the side wall horizontal vented gas fueled equipment, the installing plumber or gas fitter shall observe that a hard wired carbon monoxide detector with an alarm and battery back-up is installed on the floor level where the gas equipment is to be installed. In addition, the installing plumber or gas fitter shall observe that a battery operated or hard wired carbon monoxide detector with an alarm is installed on each additional level of the dwelling, building or structure served by the side wall horizontal vented gas fueled equipment. It shall be the responsibility of the property owner to secure the services of qualified licensed professionals for the installation of hard wired carbon monoxide detectors

a. In the event that the side wall horizontally vented gas fueled equipment is installed in a crawl space or an attic, the hard wired carbon monoxide detector with alarm and battery back-up may be installed on the next adjacent floor level.

b. In the event that the requirements of this subdivision can not be met at the time of completion of installation, the owner shall have a period of thirty (30) days to comply with the above requirements; provided, however, that during said thirty (30) day period, a battery operated carbon monoxide detector with an alarm shall be installed.

**2. APPROVED CARBON MONOXIDE DETECTORS.** Each carbon monoxide detector as required in accordance with the above provisions shall comply with NFPA 720 and be ANSI/UL 2034 listed and IAS certified.

**3. SIGNAGE.** A metal or plastic identification plate shall be permanently mounted to the exterior of the building at a minimum height of eight (8) feet above grade directly in line with the exhaust vent terminal for the horizontally vented gas fueled heating appliance or equipment. The sign shall read, in print size no less than one-half (1/2) inch in size, "GAS VENT DIRECTLY BELOW. KEEP CLEAR OF ALL OBSTRUCTIONS".

**4. INSPECTION.** The state or local gas inspector of the side wall horizontally vented gas fueled equipment shall not approve the installation unless, upon inspection, the inspector observes carbon monoxide detectors and signage installed in accordance with the provisions of 248 CMR 5.08(2)(a)1 through 4.

(b) EXEMPTIONS: The following equipment is exempt from 248 CMR 5.08(2)(a)1 through 4:

1. The equipment listed in Chapter 10 entitled "Equipment Not Required To Be Vented" in the most current edition of NFPA 54 as adopted by the Board; and

2. Product Approved side wall horizontally vented gas fueled equipment installed in a room or structure separate from the dwelling, building or structure used in whole or in part for residential purposes.

**(c) MANUFACTURER REQUIREMENTS - GAS EQUIPMENT VENTING SYSTEM PROVIDED.** When the manufacturer of Product Approved side wall horizontally vented gas equipment provides a venting system design or venting system components with the equipment, the instructions provided by the manufacturer for installation of the equipment and the venting system shall include:

1. Detailed instructions for the installation of the venting system design or the venting system components; and

2. A complete parts list for the venting system design or venting system.

**(d) MANUFACTURER REQUIREMENTS - GAS EQUIPMENT VENTING SYSTEM NOT PROVIDED.** When the manufacturer of a Product Approved side wall horizontally vented gas fueled equipment does not provide the parts for venting the flue gases, but identifies "special venting systems", the following requirements shall be satisfied by the manufacturer:

1. The referenced "special venting system" instructions shall be included with the appliance or equipment installation instructions; and

**2. The "special venting systems"** shall be Product Approved by the Board, and the instructions for that system shall include a parts list and detailed installation instructions.

(e) A copy of all installation instructions for all Product Approved side wall horizontally vented gas fueled equipment, all venting instructions, all parts lists for venting instructions, and/or all venting design instructions shall remain with the appliance or equipment at the completion of the installation.

**(3) After NFPA-54 section 10.10.4.2** add a new section 10.10.4.3 as follows:

When more than four gas appliances are to be vented through a common gas vent or common horizontal vent manifold, a plan of the proposed vent installation shall be submitted to the Inspector and the serving gas supplier for review and approval.

# Replacement Parts

**Replacement Parts**

	<b>30FID-S</b>	<b>30FID-L</b>
<b>NG Gas Valve</b>	RGCA002	RGCA002
<b>LP Gas Valve</b>	RGCA004	RGCA004
<b>NG Pilot</b>	RPA040	RPA041
<b>LP Pilot</b>	RPA043	RPA045
<b>Replacement Burner</b>	RB30FID-S	RB30FID-L
<b>Replacement Screen</b>	RSC30FID	RSC30FID
<b>Proflame 2 Control Module</b>	RCBFID	RCBFID
<b>Replacement Halogen Bulbs</b>	REC1416	REC1416
<b>Replacement Fuse</b>	REC1386	REC1386
<b>Replacement Fan Kit</b>	RFKFID	RFKFID
<b>Replacement ECO Fan Kit</b>	RFKFIDECO	RFKFIDECO
<b>Conversion Kit (NG to LP)</b>	GCA003	GCA003
<b>Red Brick Panel Set</b>	BRK30FIR	~
<b>Brown Brick Panel Set</b>	BRK30FIB	~
<b>Porcelain Panel Kit</b>	RPP30FID	RPP30FID
<b>Standard Faceplate</b>	FP30FID-01	FP30FID-01
<b>4 Sided Faceplate</b>	FP30FID4S-01	FP30FID4S-01
<b>Oversized Faceplate</b>	FP30FIDOS-01	FP30FIDOS-01
<b>Standard Trim Offset Kit</b>	FP30FIDOF	FP30FIDOF
<b>Door</b>	RDR30FID	RDR30FID
<b>Log Set</b>	LGS30FI	~



# I-Series Residential Insert Gas Fireplace



**Ferndale, Washington**  
TF: 1.800.789.6236  
FX: 1.866.3000.0927

**Langley, British Columbia**  
TF: 1.800.378.3115  
FX: 1.604.607.6462